



SUBARU BELL 412EPX
SPECIFICATIONS





Publisher's Notice

The information herein is general in nature and may vary with conditions. Individuals using this information must exercise their independent judgment in evaluating product selection and determining product appropriateness for their particular purpose and requirements. For performance data and operating limitations for any specific mission, reference must be made to the approved flight manual. Bell Textron Inc. makes no representations or warranties, either expressed or implied, including without limitation any warranties of merchantability or fitness for a particular purpose with respect to the information set forth herein or the product(s) and service(s) to which the information refers. Accordingly, Bell Textron Inc. will not be responsible for damages (of any kind or nature, including incidental, direct, indirect, or consequential damages) resulting from the use of or reliance on this information. Bell Textron Inc. reserves the right to change product designs and specifications without notice.

© 2023 Bell Textron Inc.

All registered trademarks are the property of their respective owners.

Table of Contents

SUBARU BELL 412EPX.....	1
Specification Summary (U.S. Units)	2
Specification Summary (Metric Units).....	3
Helicopter Dimensions.....	4
Bell BasiX-Pro™ Integrated Avionics System.....	6
Automatic Flight Control System	9
Safety Enhancements.....	10
Lighting and Controls.....	11
Extended Hover Performance (EHP) Kit	11
BLR Strake and Fast Fin®	12
Seating and Interiors.....	13
Mission Profiles.....	15
External Paint Schemes	18
Basic SUBARU BELL 412EPX Configuration.....	19
SUBARU BELL 412EPX Optional Accessories	22
Helicopter Performance Charts	25
Fuel Flow vs. Airspeed Charts	41
Cost of Operations.....	48
Component Overhaul.....	51
Limited Life Components	52
Global Customer Solutions	54
Training	59
Aeronautical Accessories.....	63

SUBARU BELL 412EPX

The SUBARU BELL 412EPX, also known as SB 412EPX, is the next in the generation of the Bell 412 family, providing an upgraded transmission, an electronically-controlled PT6T-9 engine, and the 2nd generation Bell BasiX-Pro™ integrated glass cockpit display system. It is a modern version of the helicopter known as the workhorse of the industry with a reputation of getting up and going to work every day in even the most extreme environments. Features are:

- **Electronically-controlled Pratt & Whitney Canada PT6T-9 Twin-Pac® engines**
 - Approximately 15% increase in hot day Take-Off power over the Bell 412EP
 - Improved HOGE, CAT-A and PC-2e performance as compared to the Bell 412EP
 - Automatic engine start with Temperature Limiting Features
 - 30-second and 2-minute OEI rating structure with automatic limiting and OEI training mode
- **Improved main transmission**
 - 11% more torque usable up to 60 knots
 - 30 min dry run certification
- **2nd Generation Bell BasiX-Pro™ integrated glass cockpit system**
 - 4 large-screen, second generation, high resolution multi-function displays providing EFIS, EICAS and systems displays along with full screen video
 - Bell's patented Power Situation Indicator (PSI) presentation
 - Garmin GTN 750 Xi NAV/COM/GPS with high resolution digital maps, approach plates and more
 - Garmin GTN 650 Xi NAV/COM/GPS
 - Approved WAAS GPS instrument approach capability
 - Digital Stand-by Flight display
 - Common operation, equipment, support with BasiX-Pro™ system on Bell 429
- **Fully integrated with Autopilot / Flight Director optimized for IFR operation – Single or Dual pilot, 3-axis or 4-axis**
- **Ease of integration / missionization for weather radar, search radar, HTAWS, TCAS, ADS-B with traffic and weather, EO/IR (Electro Optical Infrared), video displays, and velocity/hover indication**



The SUBARU BELL 412EPX Glass Cockpit

Specification Summary (U.S. Units)

WEIGHTS (lb)

Empty Weight (IFR standard configuration) ^[1]	6,815	Maximum Gross Weight (Internal/Take off)	12,200
Useful Load (Internal, IFR standard configuration)	5,385	Maximum Gross Weight (External)	13,000
Useful Load (External, IFR standard configuration)	6,185		
Maximum External Load	5,000		

PERFORMANCE SUMMARY (International Standard Day except as noted)

			Takeoff Gross Weight (lb)			
			9,500	10,500	11,900	12,200
IGE Hovering Ceiling	ISA	ft	18,100	15,400	11,900	11,100
	ISA + 20 °C	ft	16,100	13,100	8,900	8,000
OGE Hovering Ceiling	ISA	ft	15,500	12,700	9,000	8,200
	ISA + 20 °C	ft	13,100	9,900	5,100	4,000
FAA Takeoff and Landing Limit, (WAT)	ISA	ft	14,000	13,510	9,570	8,780
	ISA + 20 °C	ft	11,730	11,240	7,300	6,510
Service Ceiling (AEO - MCP) (continuous OEI)	ISA	ft	20,000	18,970	16,320	15,720
	ISA	ft	14,100	11,960	8,870	8,190
Maximum Cruise Speed (true airspeed)	4,000 ft, ISA	ktas	132	130	125	123
Cruise at Long Range Cruise Speed (LRC)						
Range ^[2]	SL, ISA	nmi	371	369	363	361
LRC Speed (average true airspeed)		ktas	127	126	124	124
Range ^[2]	4000 ft, ISA	nmi	419	413	402	398
LRC Speed (average true airspeed)		ktas	129	129	127	126
Category A Takeoff and Landing Ceiling	ISA	ft	9,900	6,590	2,140	1,390
Backup profile for ground level and elevated helipads	ISA + 20°C	ft	8510	5,370	690	(12,150 lb @ SL)
Category A Takeoff and Landing Ceiling	ISA	ft	11800	8900	5150	4370
Runway profile	ISA + 20°C	ft	10020	7030	3020	2250
Endurance at Loiter Speed ^[2]	SL, ISA	hr	4.0	3.9	3.8	3.8
	4,000 ft, ISA	hr	4.5	4.4	4.2	4.2

ENGINE RATING (100% RPM)

			Uninstalled Thermodynamic Capability	Mechanical Limit
Pratt & Whitney Canada PT6T-9 Twin-Pac®	Takeoff (5 minutes)	SHP	2 × 1,122	2 × 928
	Max Continuous Power	SHP	2 × 1,021	2 × 825
	OEI (continuous)	SHP	1 × 1,186	1 × 1,100
	OEI (2 minutes)	SHP	1 × 1,229	1 × 1,150
	OEI (30 seconds)	SHP	1 × 1,280	1 × 1,269

TRANSMISSION RATINGS (SHP at Mast)

Takeoff (5 minute) - Below 60 KIAS (103% RPM)	1567
Takeoff (5 minute) - Above 60 KIAS (100% RPM)	1370
Maximum Continuous Power - Below 60 KIAS (103% RPM)	1412
Maximum Continuous Power - Above 60 KIAS (100% RPM)	1110
Single Engine	Limited by Power Available

FUEL (usable)

Type	Aviation Turbine
Capacity	330.5 US gallons
Auxiliary (optional)	163.4 US gallons

Notes: [1] IFR Std Config includes all items listed in the Aircraft Configuration table of this document. Ballast is not included in the standard configuration (ballast is a function of installed equipment). Empty weight with standard cabin seating is 7,025 lbs.

[2] Standard fuel, no reserve, average gross weight.

Specification Summary (Metric Units)

WEIGHTS (kg)

Empty Weight (IFR standard configuration) ^[1]	3,091	Maximum Gross Weight (Internal/Take off)	5,534
Useful Load (Internal, IFR standard configuration)	2,443	Maximum Gross Weight (External)	5,897
Useful Load (External, IFR standard configuration)	2,805		
Maximum External Load	2,268		

PERFORMANCE SUMMARY (International Standard Day except as noted)

			Takeoff Gross Weight (kg)			
			4,309	4,763	5,398	5,534 ^[2]
IGE Hovering Ceiling	ISA	m	5517	4694	3627	3383
	ISA + 20 °C	m	4907	3993	2713	2438
OGE Hovering Ceiling	ISA	m	4724	3871	2743	2499
	ISA + 20 °C	m	3993	3018	1554	1219
FAA Takeoff and Landing Limit, (WAT)	ISA	m	4267	4118	2917	2676
	ISA + 20 °C	m	3575	3426	2225	1984
Service Ceiling (AEO-MCP) (continuous OEI)	ISA	m	6096	5782	4974	4791
	ISA	m	4298	3645	2704	2496
Maximum Cruise Speed (true airspeed)	1,219 m, ISA	km/h	244	241	232	228
Cruise at Long Range Cruise Speed (LRC)						
Range ^[2]	SL, ISA	km	687	683	672	669
LRC Speed (average true airspeed)		km/h	235	234	230	229
Range ^[2]	1,219 m, ISA	km	775	764	744	737
LRC Speed (average true airspeed)		km/h	239	239	235	234
Category A Takeoff and Landing Ceiling	ISA	m	3018	2009	652	424
Backup profile for ground level and elevated helipads	ISA + 20 °C	m	2594	1637	210	(5511 kg @ SL)
Category A Takeoff and Landing Ceiling	ISA	m	3597	2713	1570	1332
Runway profile	ISA + 20 °C	m	3054	2143	920	686
Endurance at Loiter Speed ^[2]	SL, ISA	hr	4.0	3.9	3.8	3.8
	1,219 m, ISA	hr	4.5	4.4	4.2	4.2

ENGINE RATING (100% RPM)

			Uninstalled Thermodynamic Capability		Mechanical Limit
Pratt & Whitney Canada PT6T-9 Twin-Pac®	Takeoff (5 minutes)	kW	2 × 837		2 × 692
	Max Continuous Power	kW	2 × 761		2 × 615
	OEI (continuous)	kW	1 × 884		1 × 820
	OEI (2 minutes)	kW	1 × 916		1 × 858
	OEI (30 seconds)	kW	1 × 954		1 × 946

TRANSMISSION RATINGS (kW at Mast)

Takeoff (5 minute) - Below 60 KIAS (103% RPM)	1169
Takeoff (5 minute) - Above 60 KIAS (100% RPM)	1022
Maximum Continuous Power - Below 60 KIAS (103% RPM)	1053
Maximum Continuous Power - Above 60 KIAS (100% RPM)	828
Single Engine	Limited by Power Available

FUEL (usable)

Type	Aviation Turbine
Capacity	1,251 liters
Auxiliary (optional)	618.5 liters

Notes: [1] IFR Std Config includes all items listed in the Aircraft Configuration table of this document. Empty weight with standard cabin seating is 3,186 kg. Ballast is not included in the standard configuration (ballast is a function of installed equipment).

[2] Standard fuel, no reserve, average gross weight.

Helicopter Dimensions

LOW SKID GEAR

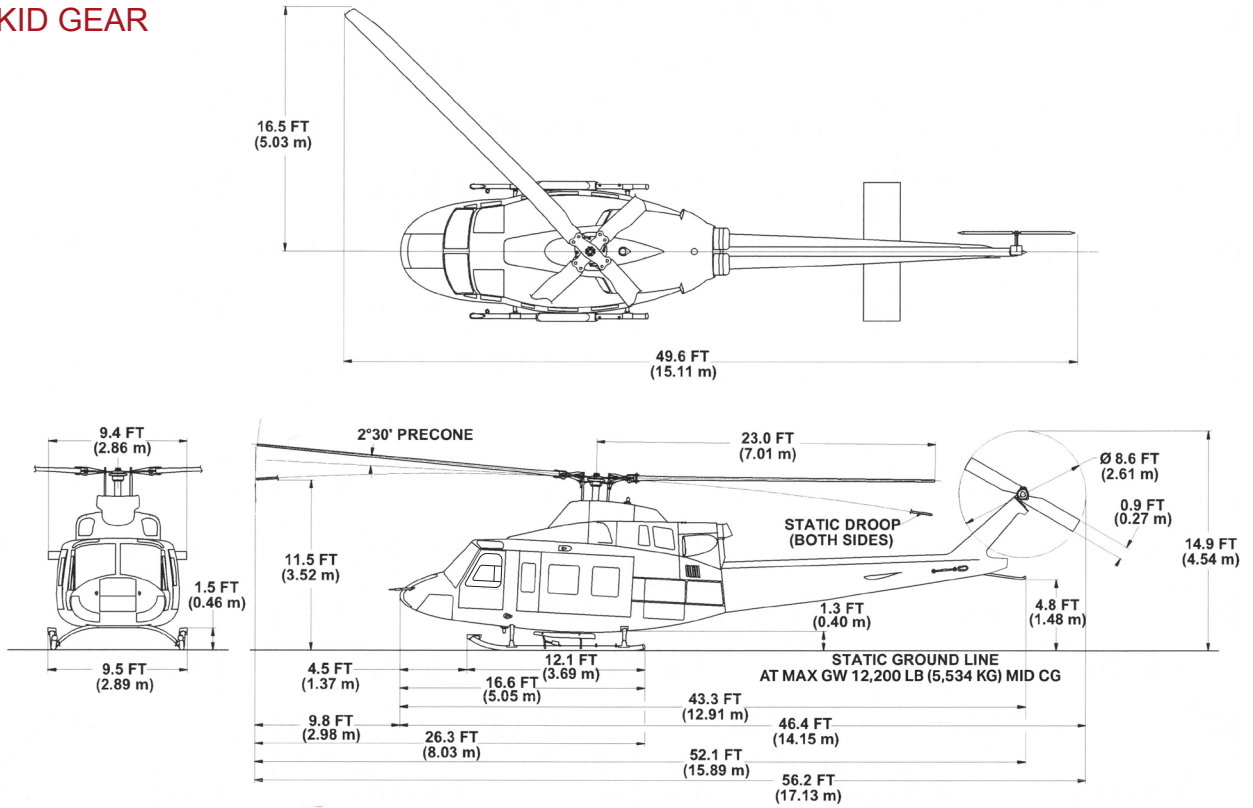

OPTIONAL HIGH SKID GEAR WITH OPTIONAL AA FLITESTEP®

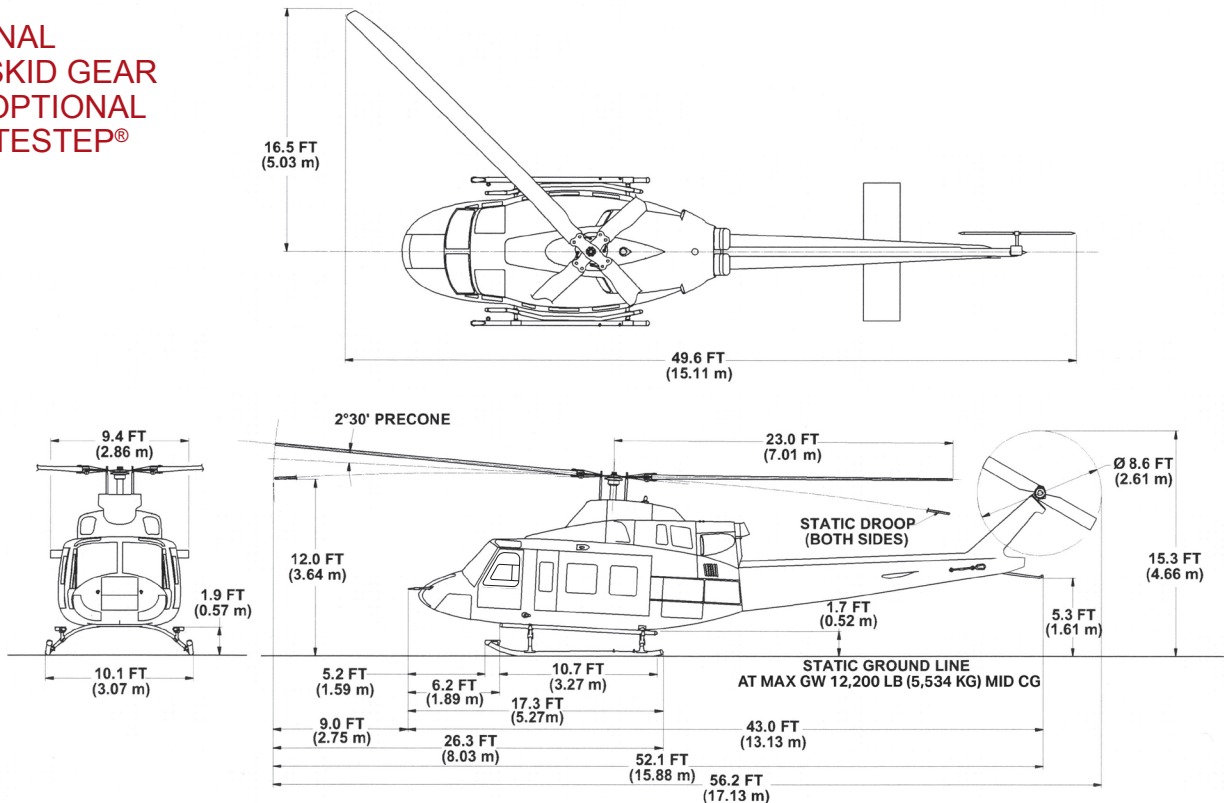

Helicopter Dimensions

OPTIONAL EMERGENCY FLOAT KIT

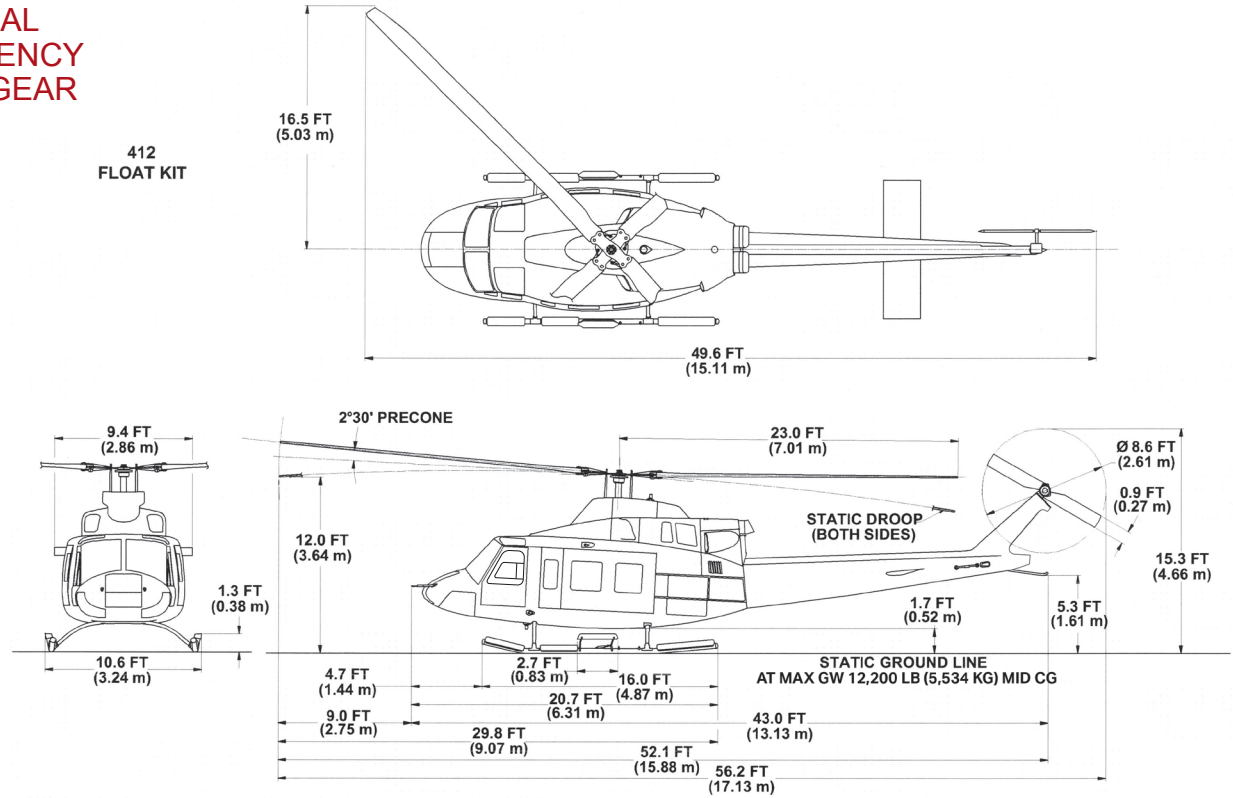

OPTIONAL BLADE FOLDING KIT DIMENSIONS

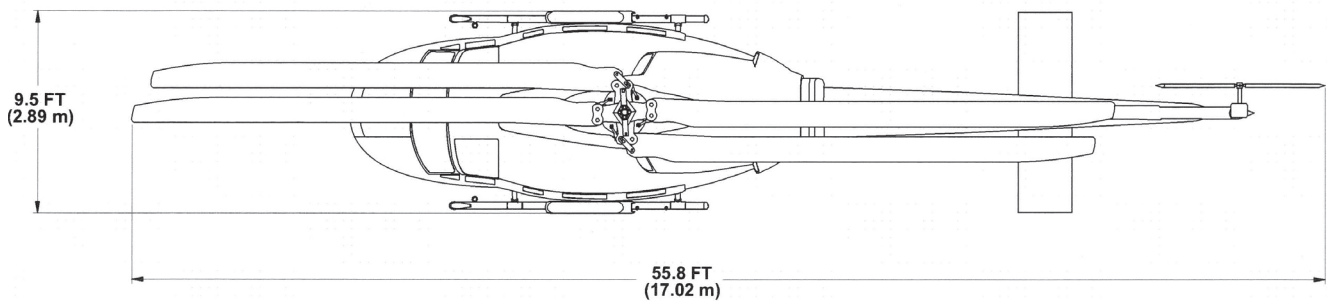

MINIMUM HANGAR SIZE

	US Units	Metric Units
Rotor not Folded	33.0 ft × 49.6 ft	10.1 m × 15.2 m
Rotor Folded	9.5 ft × 55.8 ft	2.9 m × 17.1 m

Note: Allowance should be made for high skid gear, ground wheels, empty fuel condition and door lip when considering hangar door width and height

2nd Generation Bell BasiX-Pro™ Integrated Avionics System

The Bell BasiX-Pro™ Avionics System has been specifically designed to meet the requirements of twin engine helicopters and is optimized for IFR, Category A, and EU-OPS compliant operations. The system is highly flexible and configurable to meet various operating and customization needs. The system takes advantage of the latest in display, computer processing, and digital data bus technology to provide a high degree of redundancy, reliability, and flexibility.

STANDARD CONFIGURATION

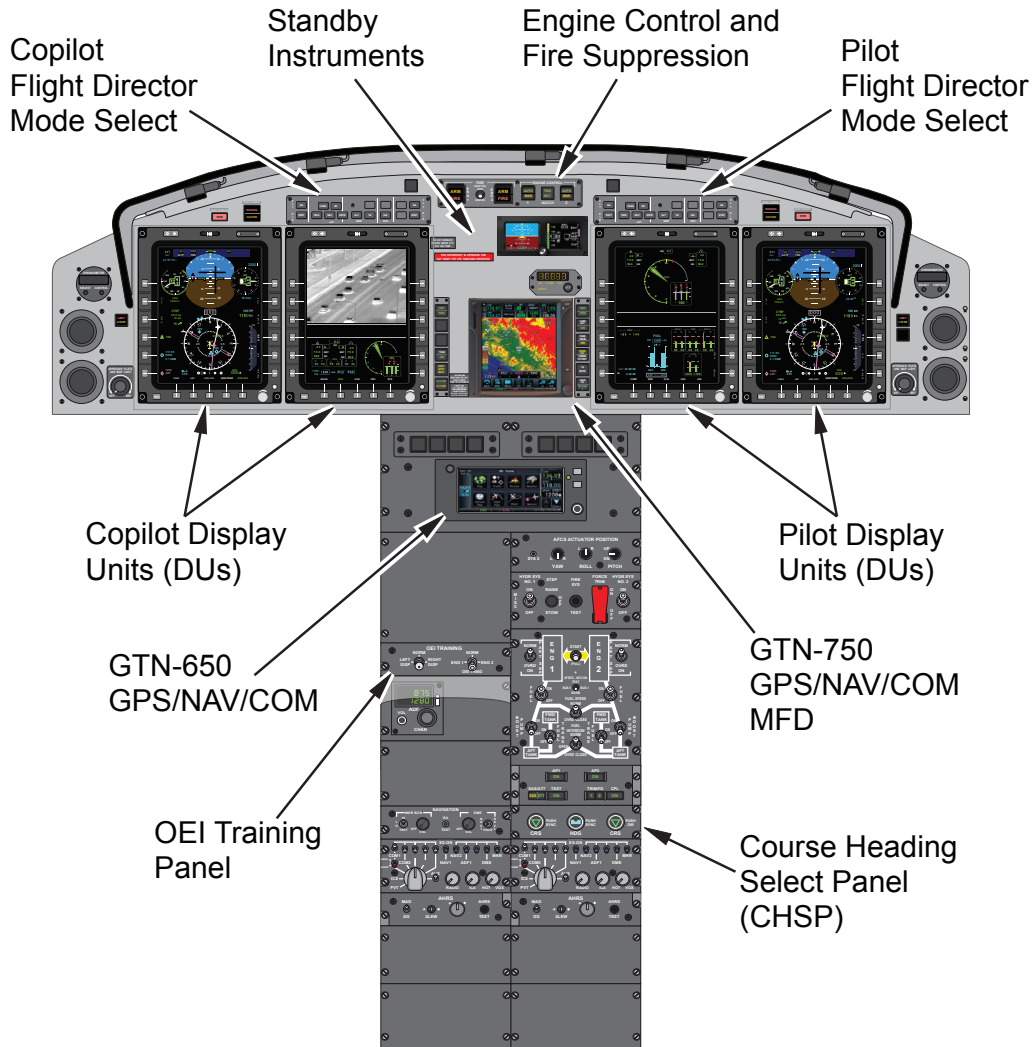

The primary components of the Bell BasiX-Pro™ Avionics System in the SUBARU BELL 412EPX include:

Four Multi-Function Display Units (DUs) with 2nd generation 6 x 8 inch high-resolution displays	Dual Channel Aircraft Data Interface Unit (ADIU)	Dual Flight Director Mode Select Panels for the Automatic Flight Control System (AFCS)	Dual Channel Air Data Computers (ADC) and Attitude Heading Reference Systems (AHRS)	Course/Heading/Select Panel (CHSP)
---	--	--	---	------------------------------------

Bell BasiX-Pro™ Integrated Avionics System

The standard configuration of the SUBARU BELL 412EPX provides single-pilot or dual-pilot IFR capability with 3-axis stability augmentation (SAS) and a coupled flight director capability. All Engine Indication and Crew Alerting System (EICAS) display functions are provided through the Bell BasiX-Pro™ Avionics System. The system works in conjunction with the engine control units (EEC/ECUs) for the Pratt & Whitney electronically-controlled PT6T-9 Twin-Pac® engines. Other aircraft systems indications, warnings, cautions, aural alerts, and automated performance features are provided through the remotely located Aircraft Data Interface Unit (ADIU).

Power and performance situational awareness is enhanced through Bell's patented Power Situation Indicator (PSI). The PSI provides a single gauge to monitor use of engine power relative to multiple limits simultaneously, and assures maximum power usage and workload reduction in OEI as operation transitions to flying RPM indication against the engine limiters. Systems monitoring workload is reduced through EICAS design for rapid scanning. Display-by-exception, normalized scales, subdued red and yellow markings except in appropriate conditions: These all contribute to reduced pilot instrument scan times through an effective EICAS design made specifically for the demands of helicopter use.

Communications and Navigation: The SUBARU BELL 412EPX provides COM1, NAV1, and GPS1, through the GTN 750 Xi, a high-resolution touch-screen display with extensive digital mapping capability, terrain presentation, electronic charts and approach plates. The GTN 750 Xi also provides the control interface for the transponder. The Garmin transponder is an ELS-compliant, Mode S transponder with 1090 MHz extended squitter and ADS-B Out reporting capability. The Garmin GTX 345R transponder adds ADS-B In functionality with the ADS-B Traffic display on the GTN 750 Xi. The SUBARU BELL 412EPX also incorporates a KRA-405B radar altimeter as part of the basic equipment.

The SUBARU BELL 412EPX adds the GTN 650 Xi as NAV2, COM2 and GPS2 completing the advanced Garmin navigation suite. A DME (KDM-706A), ADF (KDF-806), Marker Beacon (MB-10) and Audio/Intercom Panel (NAT N301A) complete the IFR certified avionics configuration. Standard installation of the NAT N301A is for high impedance headsets but the units can be alternately wired for low impedance (military style) headsets.

Display Units: The BasiX-Pro™ Multi-Function display units are “smart displays”, which are NVG-ready^[1] and include the processing required to collect sub-system information and generate display formats and graphics for the following:

- All primary flight and navigation instrumentation
- Presentation of flight director and autopilot status
- Engine and rotor drive system indications
- Electrical, hydraulic, and fuel system monitoring
- Crew alerting system (warnings / cautions / advisories and aural alerts)
- Navigation route mapping display
- CAT I LPV approach capability
- Presentation of optional Traffic Collision Avoidance Symbology (TCAS)
- Presentation of optional weather radar or search radar information
- Presentation of optional multi-sensor camera / Enhanced Vision Systems (EVS) video display

- Notes: [1] BasiX-Pro™ Display Units LCD displays are RTCA DO-275 compatible for night vision goggle use when selected to NVG backlight mode. NVG completion installs the overhead control switch required to enable NVG mode. Display Unit key legend and control lighting is NVG compatible as a standard feature. Full NVG compatibility requires all other light sources, including customization, be tested and modified if required.

Bell BasiX-Pro™ Integrated Avionics System

- Presentation of optional EOIR video with symbology
- Presentation of up to 2 additional video sources selectable via the DU
- Video/EOIR displayed in partial or full-screen with pan provided for oversized video
- High Definition video/EOIR inputs in either DVI or HD-SDI format supporting multiple aspects and DU correction for image rotation or flip
- Presentation of electrical schematic, fuel schematic, and weight and balance summary information
- Presentation of automated power assurance, Category A performance, and hover performance calculations
- Presentation of maintenance and diagnostic data
- Embedded Data Recorder with up to 75 hours of prior flight data with rapid download capability

The Bell BasiX-Pro™ system flight displays work with the LCR-100 Attitude and Heading Reference Systems (AHRS) common to the Bell 412 family.

CONFIGURATION FLEXIBILITY TO MEET OPERATIONAL NEEDS

The Bell BasiX-Pro™ includes built-in provisions to allow customized configuration of the following equipment:

- Alternate FMS / GPS systems
- Alternate ARINC-429 radio nav aids
- 2nd Radar Altimeter
- UHF / VHF Direction Finder or second ADF
- Weather / Search Radar
- Video inputs for multi-sensor camera/EVS display / general color video display / digital map display
- Designator Control Panel (allows EOIR or radar cursor designated positions to be captured as waypoints)
- Velocity Sensor (for hover cues and/or search and rescue approach options)
- L3 TACAN+ providing both TACAN navigation and replacing the KDM-706A DME
- Multi-sensor camera / EVS display
- Programmable CAS messages (cautions / warnings / advisories)

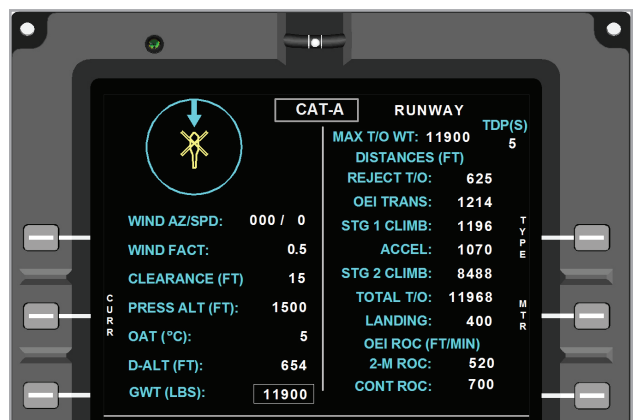

The Bell BasiX-Pro™ integrated avionics system displays automated performance calculators for quicker planning.

Automatic Flight Control System

The SUBARU BELL 412EPX utilizes the Honeywell SPZ-7600 digital Automatic Flight Control System (AFCS), providing 3-axis or 4-axis flight director capability. The SUBARU BELL 412EPX readily allows upgrade to 4-axis which provides the additional features of yaw trim, altitude pre-select, simultaneous vertical mode and speed mode coupling, automatically decelerating approaches, radar altitude hover hold, and hover velocity assist.

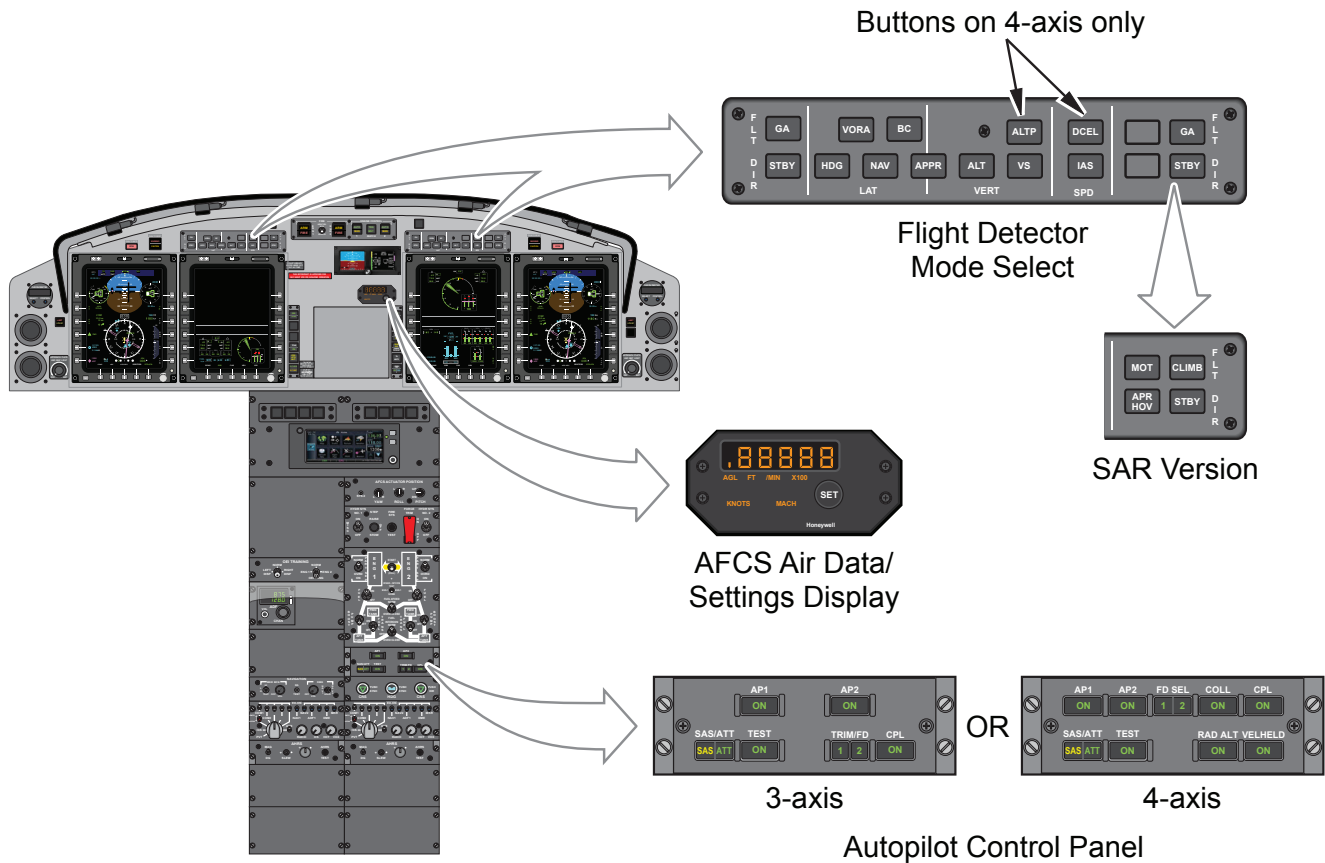

The SUBARU BELL 412EPX standard flight director modes for the 3-axis AFCS include airspeed hold, altitude hold, VS hold, heading hold, coupled navigation modes, coupled approach modes, and go around.

The optional AA Enhanced Hover Hold (EHH) STC adds a GPS-based velocity sensor and second radar altimeter to provide the AFCS with additional modes and improved hover hold performance. With EHH STC installed, the SUBARU BELL 412EPX provides automated approach-to-hover, mark-on-target (MOT), automated approach and return to hover, hover hold with commanded velocity, and automated climb and departure from hover. The velocity sensor supports hover cues on the PFD and on EOIR video overlays.

Safety Enhancements

Bell is at the forefront in providing multiple ways of satisfying evolving requirements in helicopter traffic management, flight following and terrain awareness safety. The SUBARU BELL 412EPX provides fully-coupled LPV WAAS (Localizer Precision with Vertical guidance Wide Area Augmentation System) approaches allowing precision instrument flight operation into more airports and heliports.

The Bell BasiX-Pro™ Integrated Avionics System concentrates on providing true operational capabilities and flexibility to our customers to address rapidly changing regulatory requirements and technologies, with an open architecture and flexible avionics systems solutions.

The enhancements available for the SUBARU BELL 412EPX through optional accessory kits and customizing include the Traffic Advisory System and Helicopter Terrain Awareness and Warning Systems / Enhanced Ground Proximity Warning System.

Traffic Collision Avoidance System (TCAS): Two TCAS systems available that can present on either the BasiX-Pro™ Display Units

(in PFD or MFD format) or on the GTN 750 Xi:

- **Avidyne TAS605A (recommended)** features:
 - 13 nm range
 - 5,500 ft vertical separation
 - 55,000 ft service ceiling
- **Avidyne TAS620A** features:
 - 21 nm range
 - 10,000 foot vertical separation maximum
 - 55,000 foot service ceiling



TCAS / WXR displayed on MFD Map/Radar Page

Helicopter Terrain Awareness and Warning System/ Enhanced Ground Proximity Warning System: TSO-C194 compliant HTAWS options are available:

- **Honeywell Mark XXII EGPWS HTAWS** – System available as STC adds the following features:
 - Interfaces with ADC and Rad Alt for additional modes & offshore protection envelopes
 - Provides dual TAWS images with independent range control
- **Garmin HTAWS upgrade to the GTN 750 Xi**
 - Lightest Weight, Lowest Cost solution for terrain warning
 - Displays on the GTN 750 Xi only



TCAS displayed on PFD HSI (rose format)

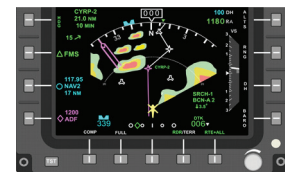

WXR displayed on PFD HSI (ARC format)



Garmin HTAWS

Lighting and Controls

Interior Lighting and Controls: The SUBARU BELL 412EPX standard cockpit controls and panels are illuminated by high-reliability LED (light emitting diode) lighting that is NVG-ready, greatly reducing the impact of completing an NVG compatible cockpit. LEDs illuminate:

- Specific cockpit push-button annunciators
- Flight Director Mode Select panels (FDMS), and Engine Control & Fire Suppression panel
- Overhead switch panels and circuit breaker panels
- Collective head control panels
- AFCS Actuator Position Indicator Panel
- Autopilot Control Panel (less push buttons)
- Miscellaneous Control Panel, Fuel Control Panel, Miscellaneous Nav Panel, AHRS Control panels, OEI training Panel, and ICS panels
- Cockpit secondary instrument lights, Cockpit Utility lights

Exterior Lighting: The six exterior navigation lights and the two red anti-collision lights are high-reliability LED assemblies.

Courtesy Lighting and External Power: The SUBARU BELL 412EPX incorporates a cockpit switch to control application of external power so that aircraft systems are not powered unnecessarily when no flight crew is aboard. When external power is applied but switched off via the cockpit control, a “courtesy lighting” feature is provided. This feature provides power to the baggage compartment lights, passenger step / external utility lights, cabin dome lights, and cockpit secondary instrument lights. This feature facilitates pre-flight / post-flight loading and unloading. The same courtesy lighting feature is provided from aircraft battery power for 5 minutes after all main aircraft power is switched off. If courtesy lights on battery power are desired at pre-flight, the 5-minute interval can be started or extended using the push button located on the sloped panel on the pilot’s side of the pedestal.

BLR Strake and Fast Fin®

Bell has collaborated with BLR Aerospace to provide its performance, safety and efficiency-enhancing Fast Fin® system as a standard feature on new SUBARU BELL 412EPX aircraft orders. The system incorporates two parallel stall strips along the tail boom and a reshaped vertical fin. These modifications combine to optimize airflow around the tail boom, improving the handling, stability and lifting capacity of the SUBARU BELL 412EPX in all environments, especially high and hot conditions.

The Fast Fin® system is a combination of two separate modifications, one to the vertical fin and the other to the tailboom. For clarity, the term Fast Fin® refers to the BLR modification that changes the shape and contour of the vertical fin. The term Fast Fin® System refers to the combined Fast Fin® and Dual Tail Boom Strake installation.

The performance benefits of this system include increased tail rotor effectiveness and higher crosswind speed tolerance at hover in certain conditions. In conditions where the aircraft is currently tail rotor limited the Fast Fin® system results in increased Weight-Altitude-Temperature (WAT) capability for takeoff, landing and in-ground-effect maneuvers, providing substantial improvement in useful load for hot/high operation. Increased gross weight performance due to the Fast Fin® System is shown in the figure, below.



SUBARU BELL 412EPX Fast Fin® system

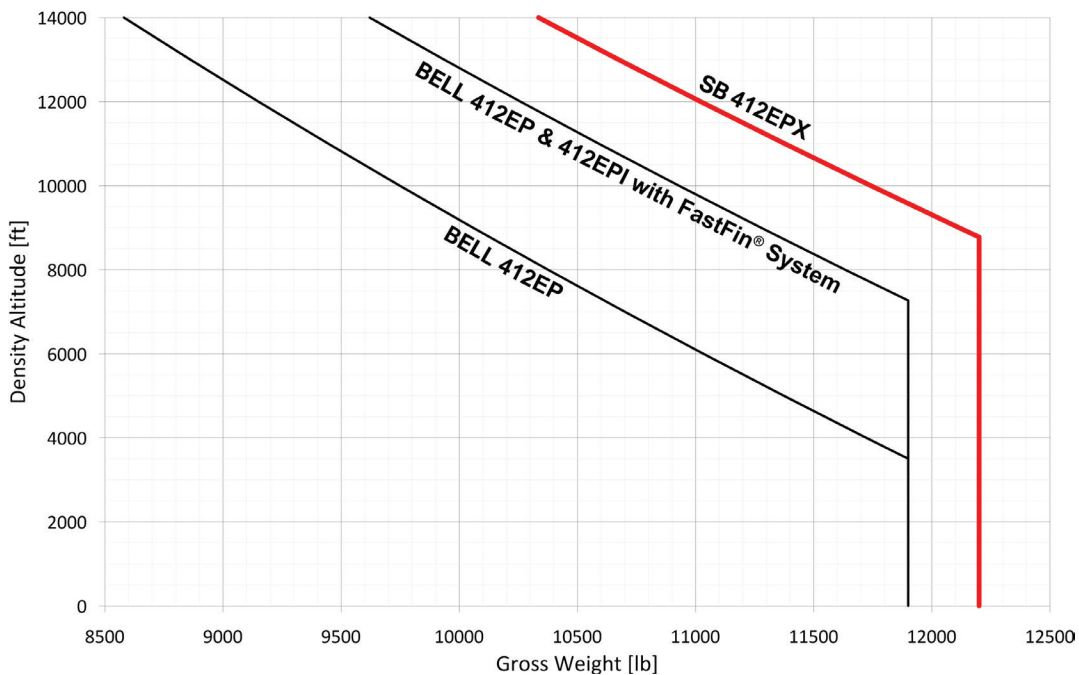

SUBARU BELL 412EPX Fast Fin® System Performance Enhancement comes Standard

Seating and Interiors

SEATS

Crew Seats: Two individual energy attenuating seats, fore/aft and up/down adjustable, each equipped with seat belt, double strap shoulder harness and inertia reel. Available with grey, blue, or tan upholstery which will match that selected for the cabin.

Passenger Seats: 13 seats offered in three options. (NOTE: Seating Option 1 meets the criteria required by FAA regulations for installation in U.S.-registered helicopters. Seating Options 2 and 3 require the addition of the STC Alpine 412 Passenger Shoulder Harness Kit for installation in U.S.-registered helicopters.)

SEATING CHOICES

1. **Standard Seating (no cost option):** Fabric covered high-backed folding seats with individual seat belts and single strap shoulder harness and inertia reel, arranged with one row of four (two 2-place benches) forward facing seats, and one row of five forward facing seats, and two outward facing two place benches (one on either side of the transmission). Available with Grey, Blue, Black, or Tan upholstery with Black seat belts. Seats are also available in vinyl or leather at additional cost. (214.5 lb [97.3 kg] included in the standard configuration weight.)
2. **Utility Seating (no cost option):** Utility Seating - Available for U.S. registered helicopters ONLY with addition of STC Alpine 412 Passenger Shoulder Harness Kit. Nylon covered bench type seating arranged with one row of four rearward facing seats (behind the crew seats), one row of five forward facing seats (in front of the transmission), and two outward facing two place benches (one on either side of the transmission). Each seat has an individual seat belt. Available in Tan or Black. The Utility Seating decreases the standard configuration weight (-95.7 lb [-43.4 kg], with Alpine STC Shoulder Harness -61.4 lb [-27.9 kg]).
3. **Cushioned Utility Seating (extra cost option):** Available for U. S. registered helicopters ONLY with addition of STC Alpine 412 Passenger Shoulder Harness Kit. As in 2) above with the addition of fabric covered cushions, available in the same colors as the Standard Seating. The Cushioned Utility Seating decreases the standard configuration weight (-53.0 lb [-24.9 kg], with Alpine STC Shoulder Harness -18.7 lb [-8.5 kg]).



Standard Seating shown with Standard Interior Trim and Floor Covering
(Utility seating options 2 and 3 not illustrated)

Seating and Interiors

INTERIOR TRIM CHOICES

1. **Standard Interior Trim (aka Deluxe Interior):** The Standard Interior Trim is provided as a NO COST OPTION, but is not included in the Standard Configuration Empty Weight. Included are: Plastic closeouts on upper sidewalls, window reveals, and cabin headliner; Padded vinyl or economic loop pile carpeting covering the floor and padded vinyl lower door panels; Lower aft bulkhead covered with padded vinyl blankets. The hard plastic headliner and closeouts are off-white in color, and the padded bulkhead blankets and floor covering are color coordinated to compliment the seat color selection. The Standard Interior Trim increases the standard configuration empty weight (165.7 lb [75.2 kg]).
2. **Utility Interior Trim:** The Utility Interior Trim consists of: Light beige vinyl covered headliner and bulkhead blankets; Doors painted light beige; Floor painted brown. The Utility Interior Trim is included in the standard configuration empty weight (32.6 lb [14.8 kg]).

CUSTOMIZED INTERIORS

Custom designed interiors are available from aircraft completion centers to meet the needs of Corporate or Emergency Medical Service customers.



Example Customized Interior shown with Corporate Club Seating and Interior Trim

Mission Profiles

MEDICAL

The SUBARU BELL 412EPX is ready to support your medical missions. With class-leading dual 7'7" sliding doors allowing for easy ingress/egress of patients on both sides simultaneously, the Bell 412 has already proven a trusty Medical platform for approximately 50 operators. Offering multiple configurations with flexible seating capacities and arrangements, the SB 412EPX can carry four medical attendants and two critical patients or up to six patients for mass casualty evacuation. With configurations as unique as your patients, the SB 412EPX supports a variety of air medical operations.



Medical

Mission Profiles

PUBLIC SAFETY

The Bell 412 has been a trusted Public Safety solution for generations. The SUBARU BELL 412EPX offers versatile configurations for a wide range of combat and support missions. The large reconfigurable, contiguous cabin enables operators to transport up to 14 combat-equipped troops in a high-density configuration. For operators executing Search and Rescue (SAR) missions, the excellent field of view, a 600 lb. hoist capacity and integrated BLR Strake and Fast Fin® ensure that no task is too tough for the SB 412EPX. Additionally, the aircraft's superior hover performance and 5,000 lb. capacity fixed-beam suspension system enable the SB 412EPX to effectively fight fires in any situation. Backed by state-of-the-art technology and a robust airframe, the SB 412EPX is designed to deploy.



Public Safety

CORPORATE

When business requires you to travel in extreme conditions, look to the SUBARU BELL 412EPX to get you there and back on time. With enough space to accommodate a VIP plus their security team or the entire board of directors in its 220 ft³ (6.2 m³) cabin, the SB 412EPX provides comfortable VIP/corporate transportation. With plenty of room to store luggage in the 28 ft³ (0.8 m³) baggage compartment, you can ride comfortably while reviewing your meeting notes or simply taking a few minutes to relax and regroup before your next appointment.



Corporate



Five Passenger Configuration

Mission Profiles

ENERGY

From powerlines to oil platforms, the SUBARU BELL 412EPX is a safe and reliable aircraft for operators executing Energy missions both onshore and offshore. Optional mission equipment enhances the aircraft's capability and makes it an ideal Energy platform. Those options include emergency floats mounted to the skid gear used in the event of a water landing, a radar that provides weather awareness and avoidance alerts, wire-strike technology and a belly-mounted high-intensity searchlight that provides nighttime visibility. Those optional features help keep you in control of your environment and out of harm's way.



Energy

GENERAL/UTILITY

The Bell 412 has always been a reputable workhorse. The SUBARU BELL 412EPX offers a more robust main rotor gearbox, dry run capability, a mast torque output of +11% at speeds below 60 knots and a phenomenal increase in External Gross Weight to 13,000 lbs. The SB 412EPX enables operators to transport more supplies, more passengers, and achieve better operational efficiency.



General/Utility

External Paint Schemes



For more color options, please visit bellflight.com or speak with a Sales Representative.

- Notes:
1. Color renderings (original) must be provided for any deviation to the standard schemes (all models).
 2. Custom paint schemes to customer specification are available, and a price quote will be provided on request. Please provide as much detail as possible when describing special instructions and custom paint schemes.
 3. The danger arrow is always applied on the tail boom between the horizontal stabilizer and the tail rotor, not withstanding any other illustrations.
 4. Unless clearly specified (location, dimension, color), registration markings will be applied per FAA regulations (all models).
 5. Metallic paint can not be applied over RADOME areas when a radar is installed.
 6. Placement of Bell model logos is effected by individual paint schemes, and will be applied at the discretion of Bell unless otherwise specified by the customer.

Basic SUBARU BELL 412EPX Configuration

AIRFRAME

Aluminum alloy fuselage (over 240 ft ³ [6.8 m ³]) loading space
Glass windshields
Tinted overhead windows
Dual windshield wipers
Fresh air ventilators with adjustable outlets (8 cockpit and 12 cabin)
Bleed air heater and defroster with air noise suppression
Cargo tie-down fittings (51 in the cabin)
Map and data case
Cabin fire extinguisher (2)
Swing-out jettisonable doors (2 for cockpit)
Sliding doors (2 for cabin access with 2 emergency exit panels on each door)
Swing-out panels for extended access to cabin (2)
Fixed step on skids for entry to cockpit cabin (2)
Retractable steps for cabin access (2)
Baggage compartment in tail boom (over 28 ft ³ [0.8 m ³], 400 lb [181 kg] capacity)
Skid-type landing gear with replaceable wear shoes
Mooring and jacking fittings (4)
External attachment fittings (16)
Semi-monocoque tailboom
Elevator (airspeed / spring-cartridge controlled)
Tail Skid
Cargo hook provisions
Baggage compartment fire and smoke detector
BLR Strake and Fast Fin®

COMMUNICATIONS and NAVIGATION

NAV1/COM1/GPS1/VOR/ILS/LOC/GS with WAAS (Wide Area Augmentation System), touch screen control. Digital maps with terrain, 8.33 KHz or 25 KHz spaced 16 W Transceiver (Garmin GTN 750 Xi)
NAV2/COM2/GPS2/VOR/ILS/LOC/GS with WAAS (Wide Area Augmentation System), touch screen control. 8.33 KHz or 25 KHz spaced 16 W Transceiver (Garmin GTN 650 Xi)
Transponder: ELS compliant Mode S with ADS-B in functionality with the Traffic display on the GTN750 Xi. ELS compliant Mode S
Distance Measuring Equipment (DME) (KDM-706A)
Automatic Direction Finder (ADF) (KDF-806)

COMMUNICATIONS and NAVIGATION (continued)

4 NAT N301A Intercommunication Systems (ICS) panels, pilot & copilot in the cockpit, and 2 in the cabin
4 Headsets – high impedance (pilot & copilot, 2 cabin)
MB-10 Marker Beacon

CREW ALERTING

Dedicated Annunciators:
CAUTION/WARNING (2)
RPM (2)
LIMIT/LTD OP (2)
Engine FIRE/ARM (2)
Engine Control AUTO/MAN (2) MGT/TRQ matching
Attention tone (occurs for warning, caution, impending exceedance or OEI limited time zone entry)
Audio Alerting:
RPM alarm
VNE alarm
Altitude Setting departure alert (voice)
Decision Height alert (voice)
100 feet or 150 feet radar altitude call out (voice)

ELECTRICAL

DC Generators (2) 28 volt, 200 ampere starter/generator
Inverters (2), (250VA volt ampere single phase, solid state)
40-Amp Hour NiCad
Generator control units/voltage regulators (2)
External power receptacle, with in-cockpit activation switch
Lighting:
Anticollision lights (2) (Red LED)
Baggage compartment light
Cockpit secondary instrument/storm lights (5) (LED)
Cockpit utility lights (2) (LED) corded & detachable
Cabin dome lights (3)
Courtesy lighting feature
Landing light, retractable (600 watt)
Map/approach plate holder lights (2)
Navigation lights (6) (LED)
Passenger step/exterior utility lights (2)
Steerable and stowable search light (450 watt)
Signs:
Self-illuminating seat belt / No Smoking signs (3)
Tritium lighted emergency exit signs

Basic SUBARU BELL 412EPX Configuration

FLIGHT and ENGINE INSTRUMENTS

EFIS/EICAS (Electronic Flight Instruments System/ Engine Indicating & Crew Alerting System):

Four 6" × 8" color LED display unit (DU) with interface provisions for future kits and customized equipment installations, each with full screen video display capability

Aircraft Data Interface Unit, Dual Channel

Course/Heading Select Panel (CHSP)

Electronic Data Recorder embedded in the Integrated Avionics System Displays Units (non-crashworthy) – up to 75 hours

Attitude & Heading Reference Systems (LCR-100 AHRS) (2)

Air Data Computers (ADC) (2)

Dual Pitot static system with electric heat

Clocks, digital quartz chronometer (Pilot/ Copilot)

Radar altimeter #1 (KRA-405B)

Standby instruments:

Electronic Standby Attitude Module (SAM) to provide indication for Altitude, Attitude, and Airspeed (MCIA MD302) includes back up battery with status indication

Magnetic compass, pilot's/copilot's standby

Free air temperature indicator

Dual Digital Automatic Flight Control System (AFCS) with 3-axis autopilot and nav-coupled flight director

Pilot / Copilot Flight Director Mode Select (3-axis version)

AL-300 Air Data & Settings Display

PC-700 Autopilot Control Panel (3-axis version)

Instrument (integral) lights (white/green)

INTERIOR

Choice of Interior Trim:

Standard Interior Trim: Rigid three-piece headliner in cabin, padded fiberglass floor covering, bulkheads, trimmed with cream-colored plastic and color-coordinated vinyl coated fiberglass, cabin doors trimmed with plastic, special soundproofing, seat upholstered with foam and fabric. Selection of fabric colors. Not included in base aircraft empty weight, increases empty weight 165.7 pounds (75.2 kilograms) when installed.

INTERIOR (continued)

Utility Interior Trim: Beige / Gray soundproofing blankets on bulkheads and overhead; doors painted beige, floor painted brown. Included in base aircraft empty weight (approximately 32.6 pounds, 14.8 kilograms)

LOOSE EQUIPMENT (not included in empty weight)

Covers, tail pipe, turbine air inlet, and pitot tube

Flight bag

Ground handling wheels, hydraulically activated

Tie-down assemblies, main rotor and tail rotor

Operating manuals:

Flight manual

Aircraft log book

Engine log book

Aircraft maintenance manuals are available on ePubs located here: <http://mybell.com>

Diagnostic and Maintenance Information Transfer System (DMITS) harness & DMITS Software

PT6T-9 Data Collection Unit (DCU) maintenance harness & software

PAINT

Markings for high visibility M / R blades (white and orange) and T / R blades (black and white)

3-color external paint

POWERPLANT

Pratt & Whitney Canada PT6T-9 Twin-Pac®

Electronic Engine Control Units (EEC / ECU) (2)

Data Collection Units (DCU) (2)

Fuel Management Module (FMM) (2)

Ignition and Starting System (2)

Fuel System (330.5 U.S. Gal [1,251 liter]) (rupture resistant cells and breakaway vent fitting)

Pumps on engines and submerged in fuel tanks

Fuel filter assembly

Oil coolers (2)

Fire detection system (2)

Fire extinguisher system (2)

Mechanical manual back-up engine control system

Hinged cowling

Basic SUBARU BELL 412EPX Configuration

POWERPLANT (continued)

Engine inlet particle separator system (2)

Combining gearbox with chip detector

Separate firewall protection for each engine

Overriding clutches (2)

Extended engine exhaust deflectors

ROTORS AND CONTROLS

Soft-in-plane flex beam hub with four fiberglass blades

Main rotor droop restraint

Pendulum vibration absorbers

Semi-rigid, two bladed, all-metal tail rotor

All controls hydraulically boosted (dual systems for main rotor)

Force trim system and artificial feel (electrically set)

Dual controls

Cyclic stick centering

Electronically controlled RPM - 100%, 103% or Auto

Rotor brake

TRANSMISSION DRIVE SYSTEM

30-minute run dry capability

Main rotor transmission with 4 chip detectors / 2 debris collectors with automatic debris burn and history logging

Vibration isolation / suspension mounts (4)

Main lift link (single point suspension)

42° gearbox (sight gage and magnetic drain plug with monitored chip detector, automatic debris burn and logging)

90° gearbox (sight gage and magnetic drain plug with monitored chip detector, automatic debris burn and logging)

Hydraulic pumps for controls (2 independent systems)

Transmission oil cooler

SUBARU BELL 412EPX Optional Accessories

Refer to notes for kit compatibility. Additional kits and STC items may be available for factory installation. Please consult sales or contract personnel regarding special needs prior to selection of final configuration.

OPTIONAL ACCESSORIES

Kit Description	Weight		Notes
	lb	kg	
AIRFRAME (Bell kits)			
Fixed Step Left Hand	11.6	5.3	1, 2, 3
Fixed Step Right Hand	11.6	5.3	1, 2, 3
Heavy Duty High Skid Gear without Steps	18.5	8.4	1, 3
Emergency Floats (provisions)	51.8	23.5	4
Emergency Floats / Reservoir and Nose	97.5	44.2	4
Emergency Floats (Landing Gear with Floats and Power Steps)	168.8	76.6	1, 4
Heated Windshield	9.8	4.4	1
Aux Fuel Provisions	5.4	2.5	5
Aux Fuel, 81.7 gal L/H (requires removal of 2 outboard-facing passenger seats)	50.3	22.8	5
Aux Fuel, 81.7 gal R/H (requires removal of 2 outboard-facing passenger seats)	50.3	22.8	5
AVIONICS (Bell kits and Aeronautical Accessories STCs)			
4-axis AFCS and Flight Director Upgrade Kit	26.4	12.0	
CV/FDR Combined Unit with RIPS (AA STC)	19.3	8.7	
CV/FDR Combined Unit with RIPS with QAR (AA STC)	20.2	9.2	
HTAWS Honeywell Mark XXII EGPWS (AA STC)	12.1	5.5	
HTAWS Garmin GTN Upgrade (BHT STC)	.4	.18	
Helicopter Vibration Monitoring System (HVMS BHT/AA STC)	33.0	15.0	
Traffic Collision Avoidance – Avidyne TAS-605A	12.0	5.4	
Emergency Locator Transmitter (ELT) ARTEX C406N-HM (AA STC)	6.0	2.7	
AVIONICS (Aeronautical Accessories compatible customizing or STCs)			
13-position Cabin Intercom System with Cabin Isol./Call	10.0	4.5	6
Weather Radar (Honeywell ART/RDR-2000) (Displays on the GTN 750 Xi only)	40.0	18.2	7
Search, Rescue and Weather Avoidance Radar (Telephonics RDR-1600)	68.0	30.8	7
ENVIRONMENT			
Heavy Duty Heater	10.3	4.7	1, 8
Air Conditioning (Air Comm STC)			
53 Amp-hr Ni-Cad Battery			

SUBARU BELL 412EPX Optional Accessories

OPTIONAL ACCESSORIES

Kit Description	Weight		Notes
	lb	kg	
EQUIPMENT			
Litter Provisions - 6-Place Litter Kit (Non-FAA)	-180.6	-81.9	1, 9, 16
Cargo Hook Equipment (provisions are part of basic ship build)	33.8	15.4	10
External Hoist Provisions and Equipment - 600 lb, capacity	185.3	84.1	
Gross Weight Towing Puller Equipment (Loose)	N/A	N/A	
3-Place Litter Kit (FAA Aircraft) plus Attendant Seat (airline passenger seats removed)	-54.8	-29.4	11, 16
3-Place Litter Kit (Non-FAA) plus (2) Attendant Seats	111.7	50.7	16
Internal Hoist Provisions	8.9	4.0	
Hoist Cable Guard (for Internal hoist)	5.2	2.4	
Gross Weight Towing Puller Provisions	2.9	1.3	
INTERIOR			
Utility Interior – Insulation Blankets	0	0	
Utility Seats (Rag and Tube - Not FAA, removes standard airline seats)	-93.3	-42.3	1,13
Seat Cushions (for Rag and Tube Seats)	12.2	5.5	
One Man Seat (2 forward-facing, replaces 4 LH/RH outboard-facing)	-2.5	-1.1	1
Std Deluxe Interior (hard plastic)	165.7	75.2	1
OTHER STC EQUIPMENT			
Alpine Shoulder Harness Kit (for utility seats)	33.8	15.3	13
Wire Strike Protection System (WSPS) - Recommended kit	19.2	8.7	14
CREDIT, EQUIPMENT			
No Ground Handling Wheels	180.0	81.6	
No Electrical Powered Steps	-21.0	-9.53	1
No Passenger Seats - Airline	-210.0	-95.2	1
PAINT			
No Exterior Paint	-30.9	-14.0	
White Paint Only	0.0	0.0	
Low Visibility Main Rotor Blade Paint	0.0	0.0	15

EXPLANATORY NOTES

For commonality, notes shown below are identical in Product Specification and Price List.

1. Price and/or Weight includes credit for basic ship hardware removed.
2. Fixed steps not compatible with emergency pop out floats or rescue hoist.
3. FAA requires either standard electric powered steps or fixed steps to conduct passenger carrying operations.
4. For a complete installation of Emergency Floats, provisions, reservoir, and landing gear are required.
5. Aux Fuel Provision Kit must be installed prior to or concurrently with installation of aux tank kits. Aux fuel tank kits can be installed in any combination with maximum of two per aircraft (one per side). Total auxiliary

SUBARU BELL 412EPX Optional Accessories

fuel volumes possible are 81.7 and 163.4 gallons.

6. Accommodates up to 13 cabin headsets; headset weight not included; headsets are priced separately.
7. Customizable Radars: The Bell BasiX-Pro™ system is engineered to display information from the Telephonics RDR-1600 Search/Weather radar. RDR-2000 radar customizing available, displayed only on the GTN 750 Xi. A radar with 2.5 nm max range display or less (P660 or RDR-1600) is required for approvable off-shore radar approaches.
8. Note that operation of the heavy duty heater imposes a larger performance reduction than the standard heater. Relative performance of the two heater options is as shown in the figure, right.
9. The 205-706-047 6-place Litter Provisions Kit is not FAA certified. Kit is provisions only; does not include cots or attendant seats. Weight is for all standard airline seats removed.
10. Cargo Hook Provisions must be installed prior to Cargo Hook Equipment.
11. The 412-706-006-105 3 Place Litter Kit is FAA certified. Weight includes removal of Row 1 and Row 2 standard airline seats, and one attendant seat installed.
12. Battery-driven engine starts with the standard 40 Amp Hour NiCad battery are limited to aircraft cold-soak temperatures above 0 °C (32 °F) For battery-driven engine starts down to aircraft cold-soak temperatures of -25 °C (-13 °F) a 53 Amp-Hour battery is required.
13. Utility Seating is available on U. S. registered helicopters ONLY with the addition of the STC'd Alpine 412 Passenger Shoulder harness Kit.
14. The Wire Strike Kit is a RECOMMENDED extra cost option. The customer must specify on the Purchase Agreement for the WSPS Kit NOT to be installed.
15. Low Visibility or High Visibility Main Rotor Blade Paint to be specified by Sales Order.
16. Kit is available as loose equipment.

STC Kits: Select Supplemental Type Certificated Optional Equipment Kits are available for installation at the Bell Textron Inc. factory. Please contact your Bell Sales Representative for availability and pricing information.

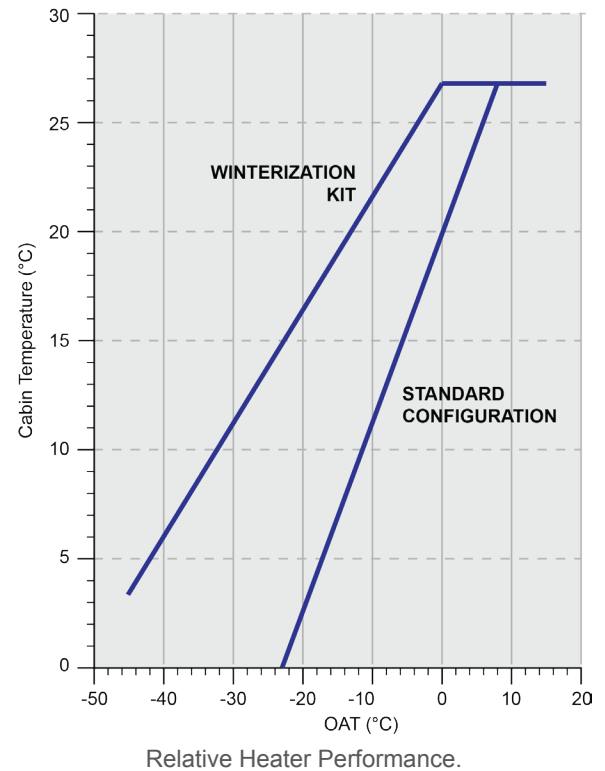

Helicopter Performance Charts

IGE Hover Performance and OGE Hover Performance charts are presented in a revised format which should simplify the comparison of Weight Altitude Temperature (WAT) limited Take Off and Landing Capability and the Hover Capability for known favorable wind conditions.



Helicopter Performance Charts

IGE HOVER PERFORMANCE, COMBINED WAT LIMITED AND HOVER CAPABILITY

Conditions:

- 10 or more passenger seats, and 9 or less passenger seats
- AEO takeoff power
- Heater off
- 103% RPM

Compare hover capability (found in the top chart) with FAA takeoff and landing (WAT) limitations (found in the bottom chart). The full hover capability is available for external cargo operations (see BHT-412-FMS-9.6) and the lower of the two weights represents the FAA approved takeoff and landing envelope.

Example:

- Wanted: IGE hover weight for the 9 or less passenger seat configuration
- Known: Pressure Altitude = 10,000 ft, OAT = 20 °C

Method:

1. To determine the IGE hover weight, enter the IGE hover capability chart at a pressure altitude of 10,000 ft. Move horizontally to the right to intersect the 20 °C line. Move vertically down to read a hover capability of 11,175 lb.
2. To determine the WAT limited gross weight, enter the IGE WAT limitation chart at 20 °C. Drop vertically down to intersect the 10,000 ft pressure altitude line. Move horizontally to the right to intersect the 9 or less passenger seats WAT line. Move vertically up to read 11,350 lb. This is the WAT limited gross weight.
3. The lower of Step 1 and Step 2 will result in a correct IGE hover weight of 11,175 lb.

IGE Hover Capability

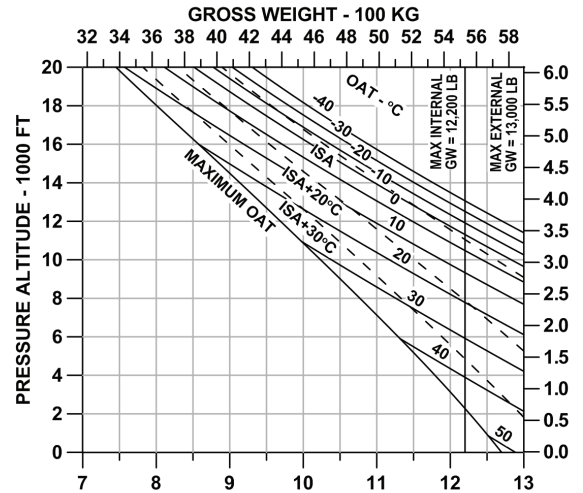

FAA Takeoff and Landing Limitation (WAT)

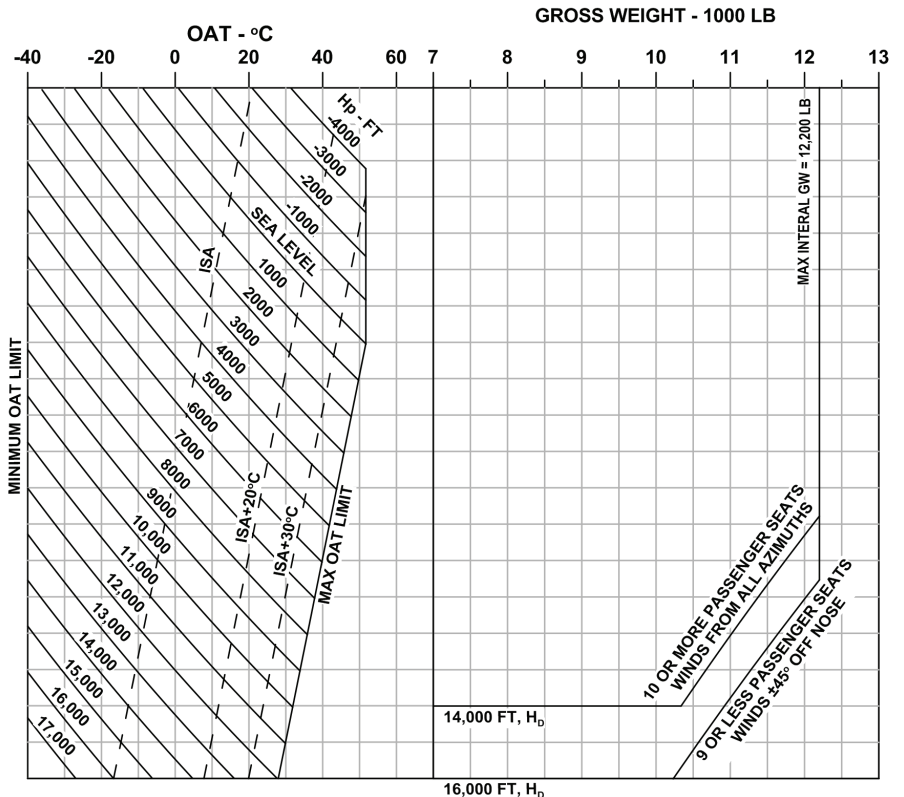

IGE Hover WAT Limitation

Helicopter Performance Charts

OGE HOVER PERFORMANCE, COMBINED CONTROLLABILITY LIMITED AND HOVER CAPABILITY

Conditions:

- All azimuth controllability and restricted wind azimuths
- AEO takeoff power
- Heater off
- 103% RPM

Compare hover capability (found in the top chart) with all azimuth controllability limitations (found in the bottom chart). The full hover capability is available for restricted wind azimuths (see BHT-412-FM-6) and the lower of the two weights represents all azimuth hover performance.

Example:

- Wanted: OGE hover weight for the all wind azimuths
- Known: Pressure Altitude = 10,000 ft,
OAT = 20 °C

Method:

1. To determine the OGE hover weight, enter the OGE hover capability chart at a pressure altitude of 10,000 ft. Move horizontally to the right to intersect the 20 °C line. Move vertically down to read a hover capability of 10,150 lb.
2. To determine the controllability limited gross weight, enter the OGE WAT limitation chart at 20 °C. Drop vertically down to intersect the 10,000 ft pressure altitude line. Move horizontally to the right to intersect the all wind azimuth line. Move vertically up to read 10,200 lb. This is the controllability limited gross weight.
3. The lower of Step 1 and Step 2 will result in a correct OGE hover weight of 10,150 lb.

OGE Hover Capability

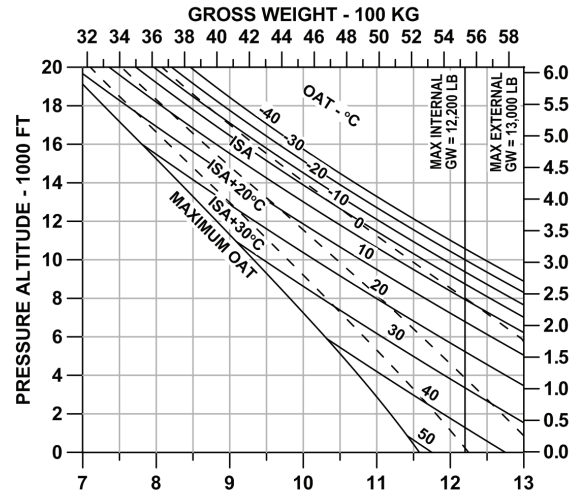

OGE All Azimuth Controllability Limitation

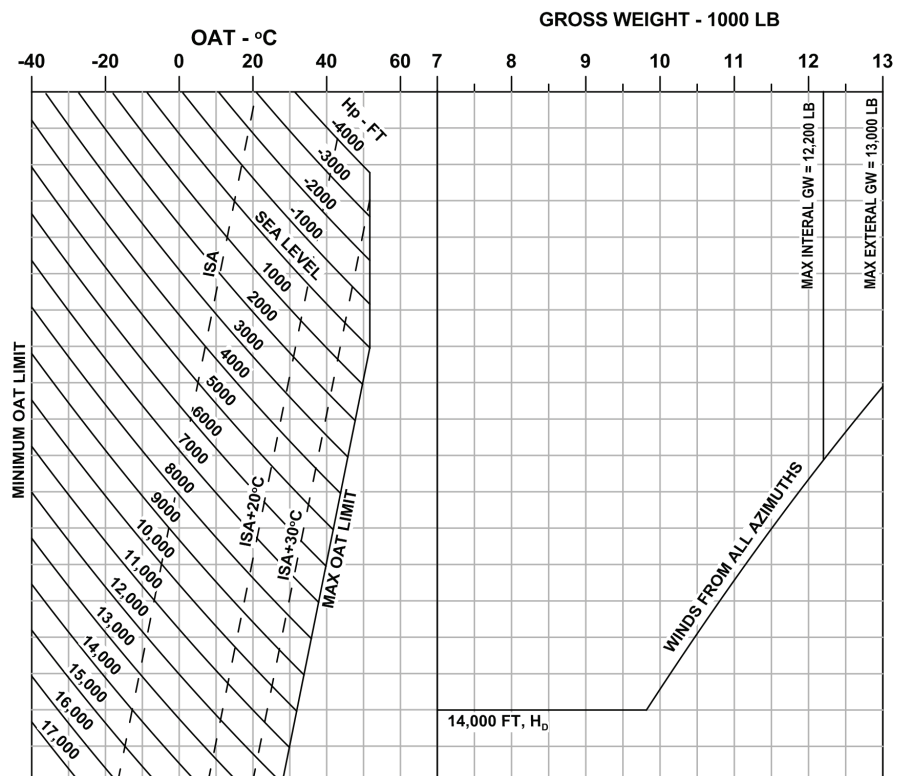

Helicopter Performance Charts

SERVICE CEILING

Conditions:

- Twin engine operation at maximum continuous power

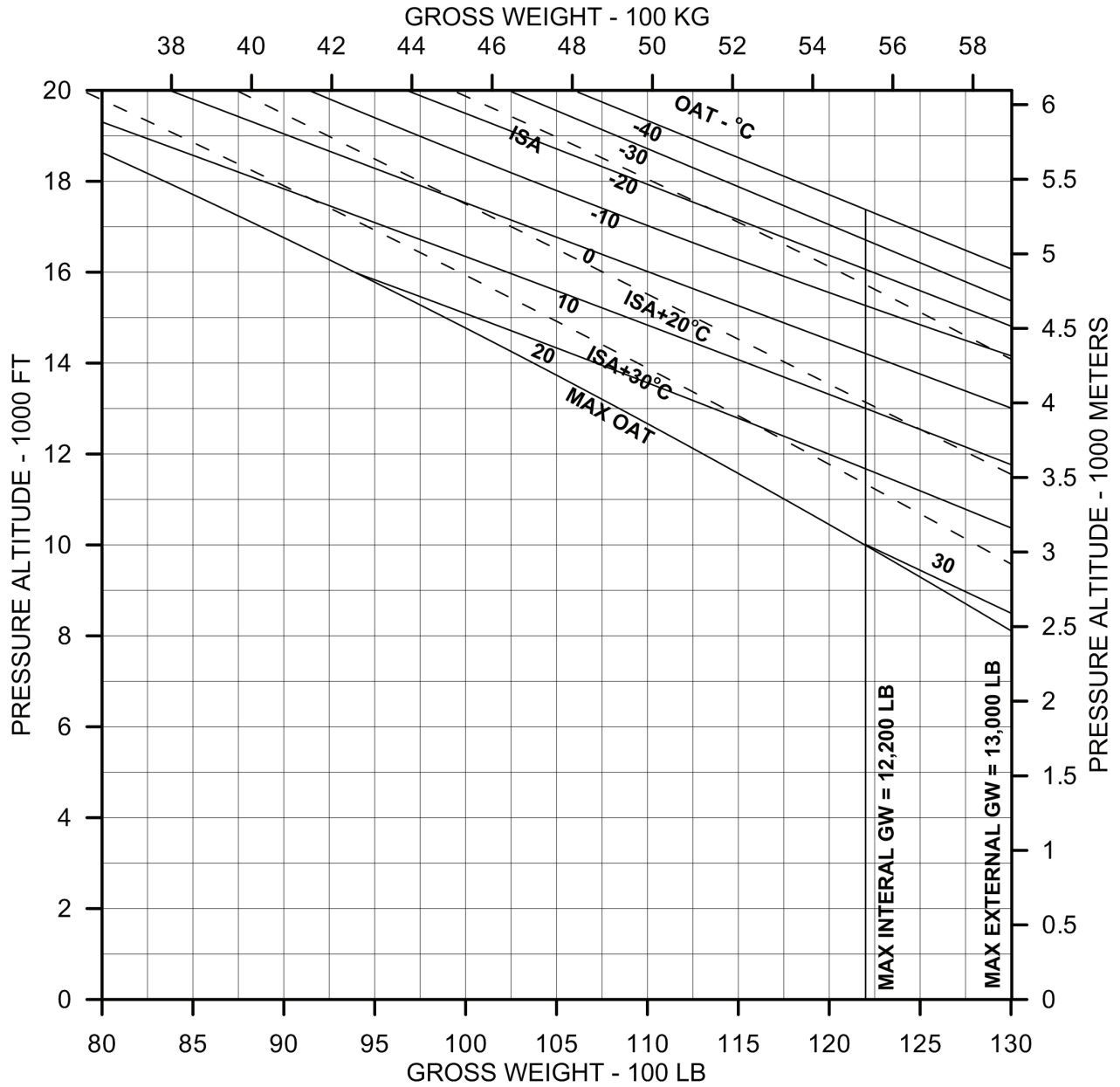

Helicopter Performance Charts

SERVICE CEILING

Conditions:

- Single engine operation at continuous OEI power

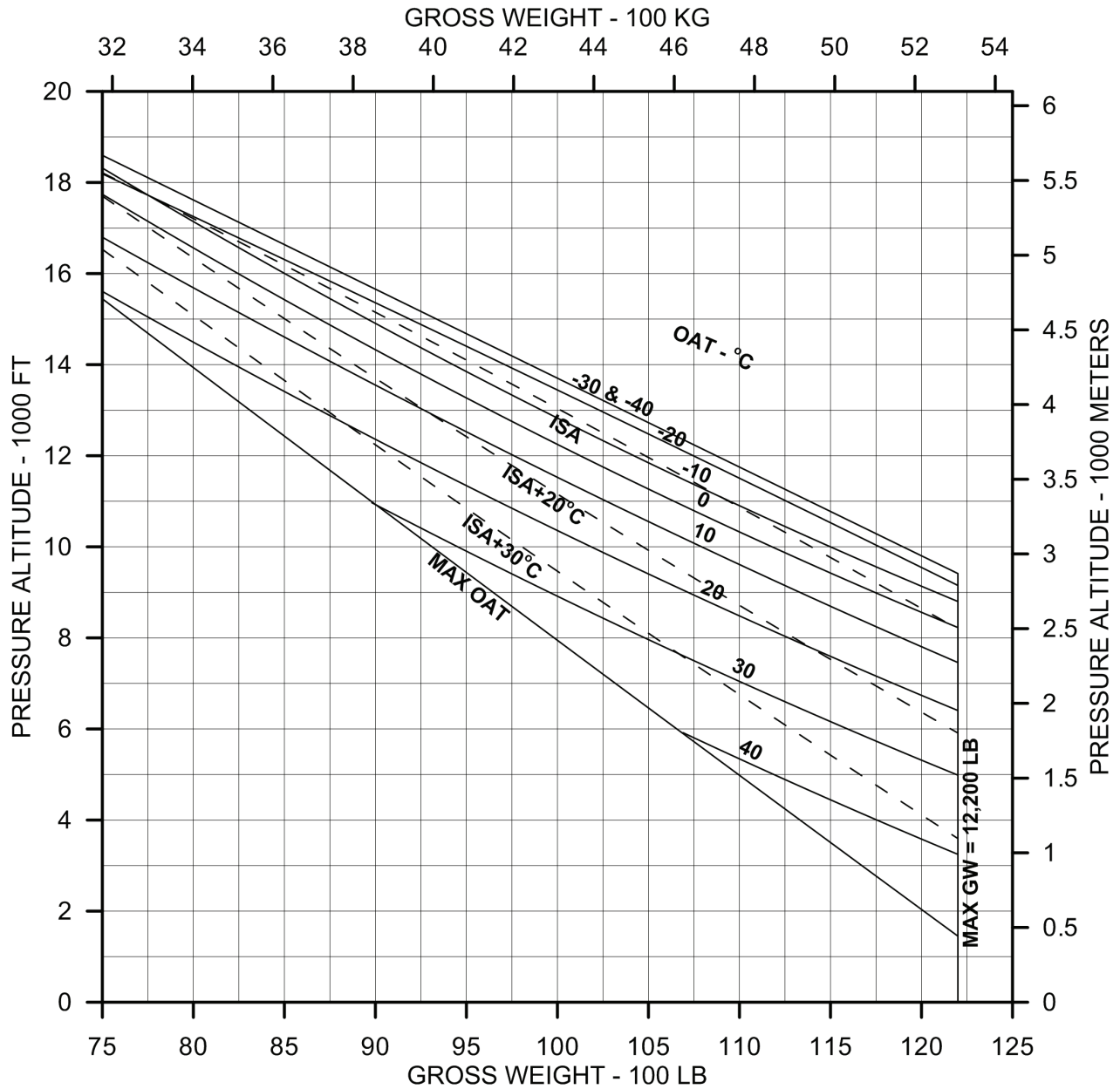

Helicopter Performance Charts

CATEGORY “A” PERFORMANCE

Conditions:

- Backup Profile - for ground level helipads or elevated helipads where no drop-down below the takeoff surface is allowed.
- Side Step Profile - for elevated helipads with allowable drop down
- Runway Profile - for runways and short fields

Equipment required (installed and functional) to perform Category A operations:

All profiles

- Radar altimeter (visible to both pilots)

Side Step Profile only

- Dual Controls
- Copilot instruments
- Pilot and Copilot ICS

Note: Category A operations using all three profiles may be flown single (right seat only) or dual pilot.

Information on the following pages provides a brief explanation of Category A Operation capability for the SUBARU BELL 412EPX with the Pratt & Whitney Canada PT6T-9. The WAT charts included may be used to determine takeoff or landing weight capability. Additional information is available in the FAA approved rotorcraft flight manual supplement, BHT-412-FMS-62.6.

DEFINITIONS

<p>Category “A” Takeoff</p>	<p>Operation of the helicopter in such a manner that if one Engine fails at any time after the start of the takeoff the Helicopter can:</p> <ol style="list-style-type: none"> 1. Prior to the Takeoff Decision Point (TDP), return to and safely stop on the takeoff area; or 2. At or after the TDP, climb out from the point of failure and attain single engine forward flight.
<p>Category “A” Landing</p>	<p>Operation of the helicopter in such a manner that if one engine fails at any time during the landing approach the Helicopter can:</p> <ol style="list-style-type: none"> 1. At or prior to the Landing Decision Point (LPD), climb out from the point of failure and attain single engine forward flight; or 2. After the LPD, safely stop on the landing area.

Helicopter Performance Charts

CATEGORY “A” NORMAL TAKEOFF - BACKUP PROFILE

Conditions:

- Category A Backup Profile Normal takeoff (AEO) from ground level and elevated helipads with all engines operating

BACKUP PROFILE EXPLANATION

Backup Profile Takeoff Profile (Day and Night)	The takeoff technique consists of a vertical/rearward takeoff to the TDP (100 ft or higher based on density altitude); then acceleration and subsequent climbout at V_Y (70 kias), to 1,000 ft.
Ground Level or Elevated Helipad	For a ground level or elevated helipad the associated takeoff and landing limit chart assures 15 ft (4.6 m) ground level clearance in case of an engine failure at or after TDP. The minimum helipad is a circular landing pad 50 ft (15.2 m) in diameter.

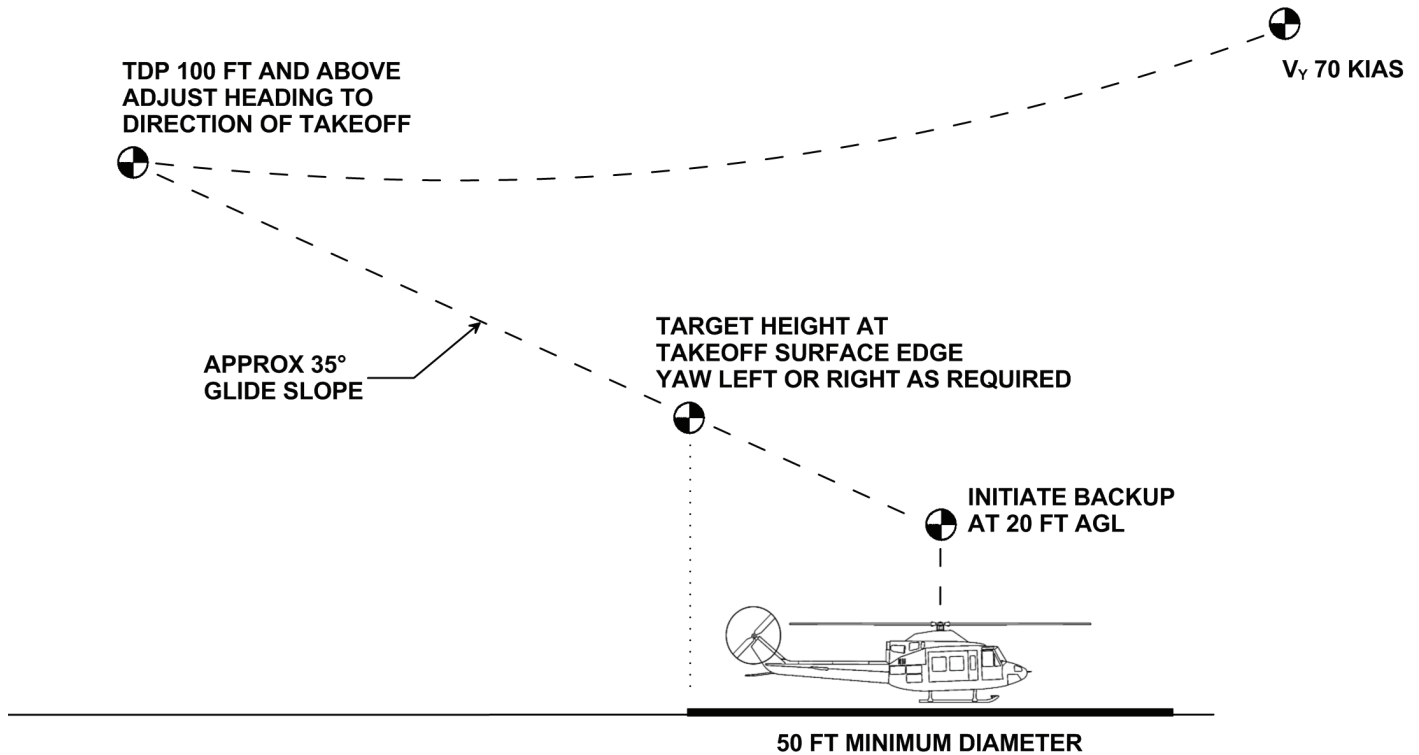

Normal takeoff (AEO) with all engines operating

Helicopter Performance Charts

CATEGORY "A" NORMAL LANDING - BACKUP PROFILE

Conditions:

- Normal landing (AEO) to ground level or elevated helipad with all engines operating

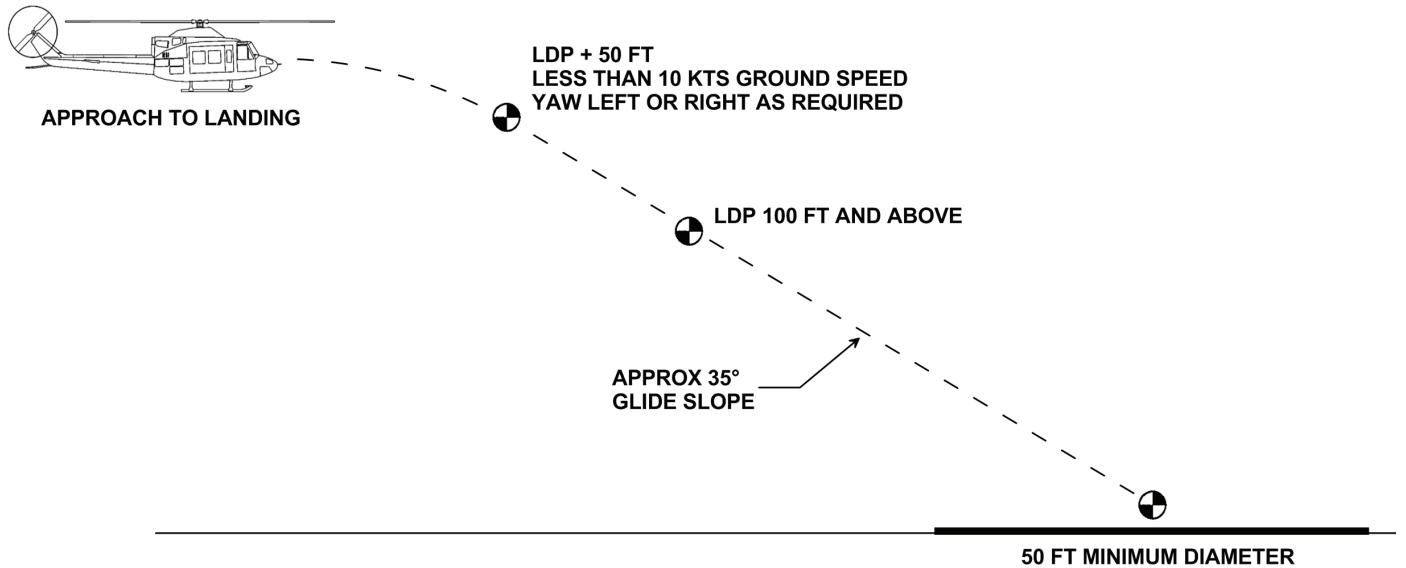

Normal landing (AEO) all engines operating

CATEGORY "A" EMERGENCY TAKEOFF OR LANDING - BACKUP PROFILE

Conditions:

- One Engine Inoperative (OEI)
- V_{ROT} = Rotate speed (velocity where airspeed indicator has perceptible motion).

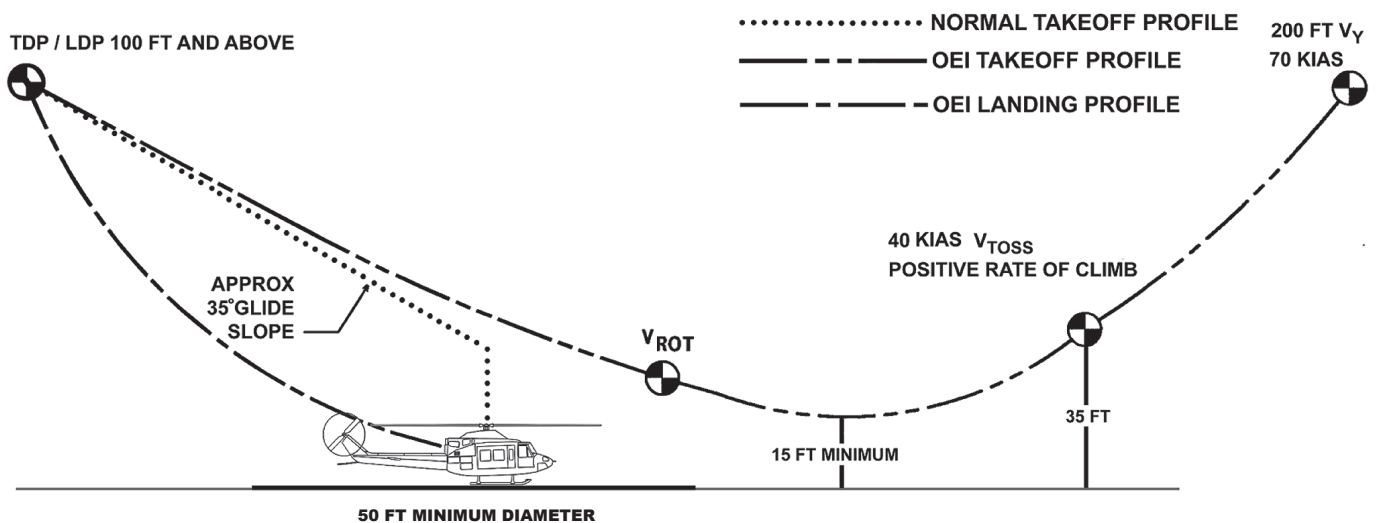

Emergency takeoff or landing with one engine inoperative

Helicopter Performance Charts

CATEGORY "A" TAKEOFF AND LANDING LIMIT - BACKUP PROFILE

Conditions:

- Ground level or elevated helipad (day and night)
- 103% rotor RPM (AEO)

Method:

1. Enter the chart at the pressure altitude of the takeoff / landing helipad
2. Follow the graph line horizontally to the appropriate OAT (outside air temperature) trend line.
3. Follow the graph line vertically to the appropriate gross weight capability with zero headwind.
4. To account for headwind follow the graph line vertically from the zero headwind gross weight down to headwind chart, and follow guideline until appropriate headwind horizontal line is reached.
5. From that point move vertically downward to determine takeoff gross weight capability with unfactored headwind.

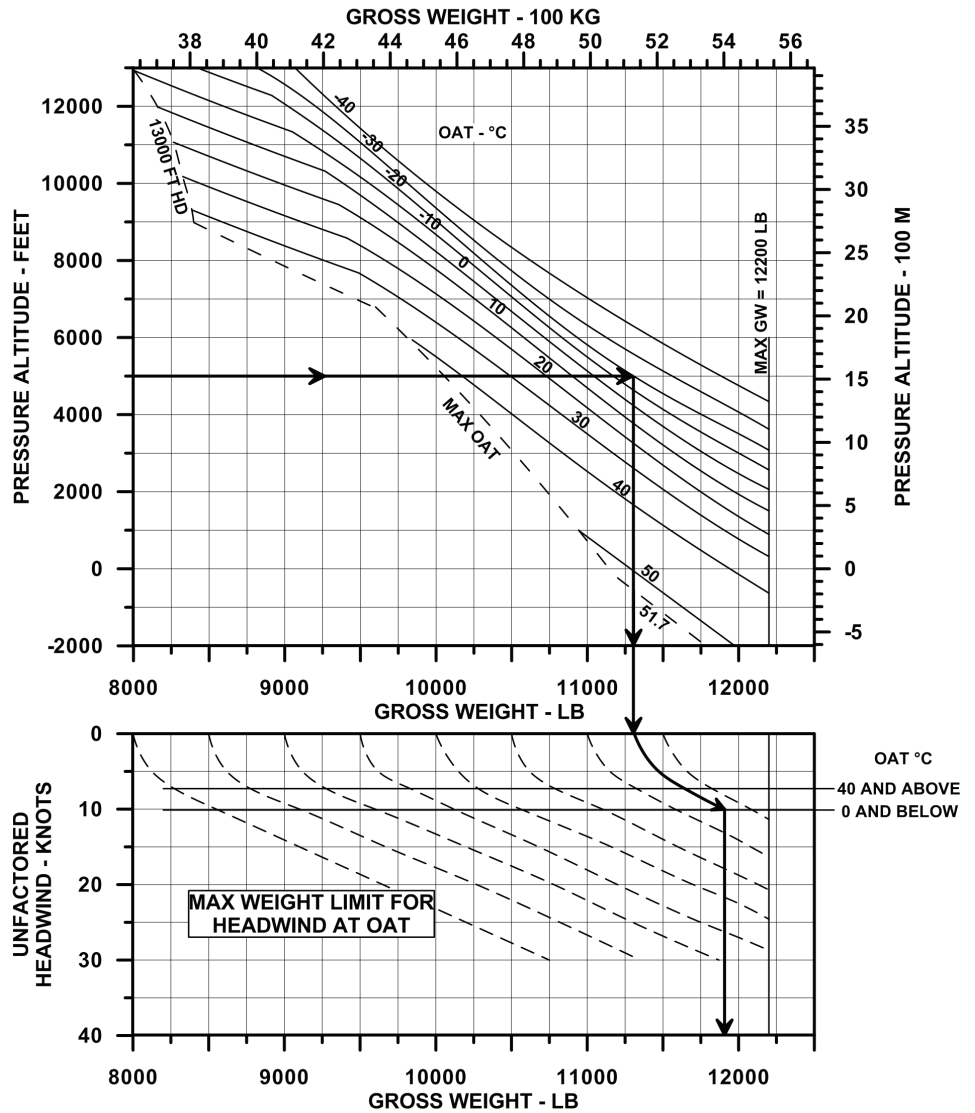

Note: Category A takeoff and landing using the Backup profile has not been demonstrated and is not approved above 13,000 ft (3,962 m) density altitude.

Helicopter Performance Charts

CATEGORY “A” NORMAL TAKEOFF - SIDE STEP PROFILE

Conditions:

- Normal takeoff (AEO) from elevated platform with all engines operating

SIDE STEP PROFILE EXPLANATION

Elevated Helipad Takeoff Profile (Day and Night)	The takeoff technique consists of a vertical takeoff to 35 ft, and lateral movement 35 ft from the center of the helipad to the TDP; then acceleration and subsequent climbout at V_y (70 kias), to 1,000 ft.
Elevated Helipad	For a helipad 105 ft (32 m) high or greater, the associated takeoff and landing limit chart assures 15 ft (4.6 m) vertical obstacle clearance after TDP. Additional charts are available in the rotorcraft flight manual supplement for reduced drop down height. The minimum elevated helipad dimension is 50 ft (15.2 m) in diameter and must be positioned so that one edge is within 30 ft (9.1 m) of a vertical drop.

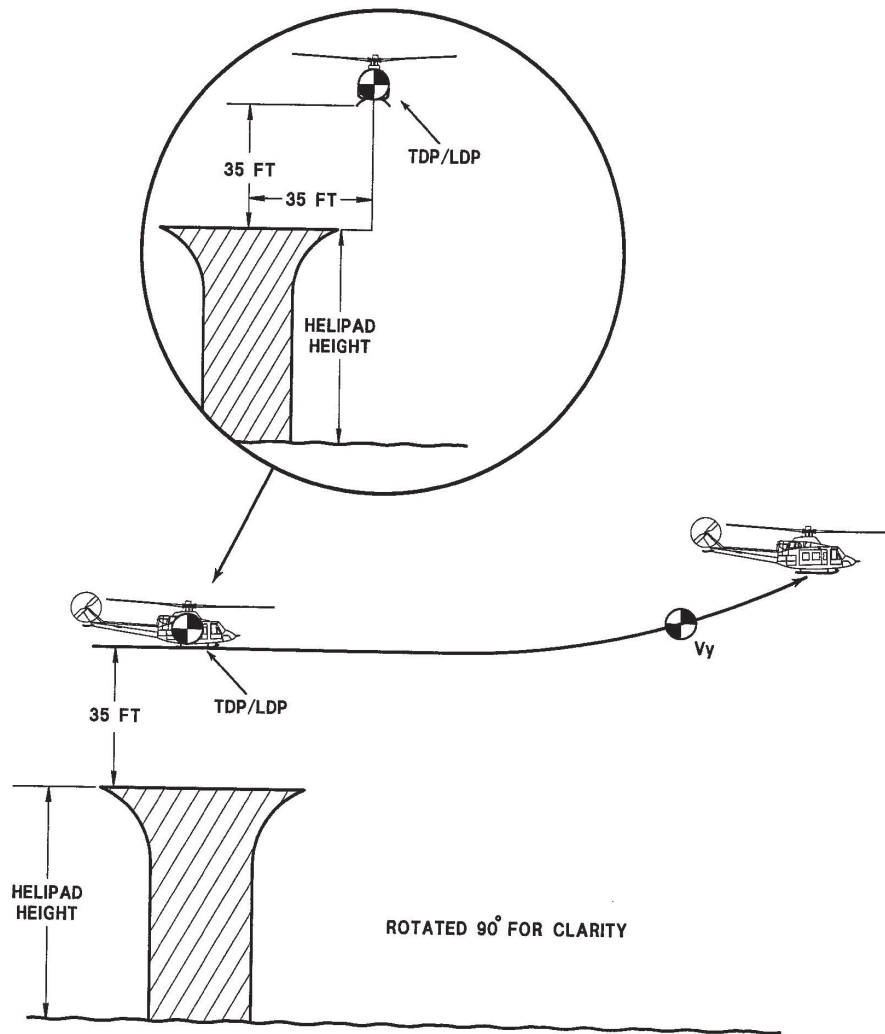

Normal takeoff (AEO) from elevated platform with all engines operating

Helicopter Performance Charts

CATEGORY "A" EMERGENCY TAKEOFF - SIDE STEP PROFILE

Conditions:

- Emergency takeoff or landing (OEI) from elevated platform with one engine inoperative
- V_{ROT} = Rotate speed (velocity where airspeed indicator has perceptible motion).

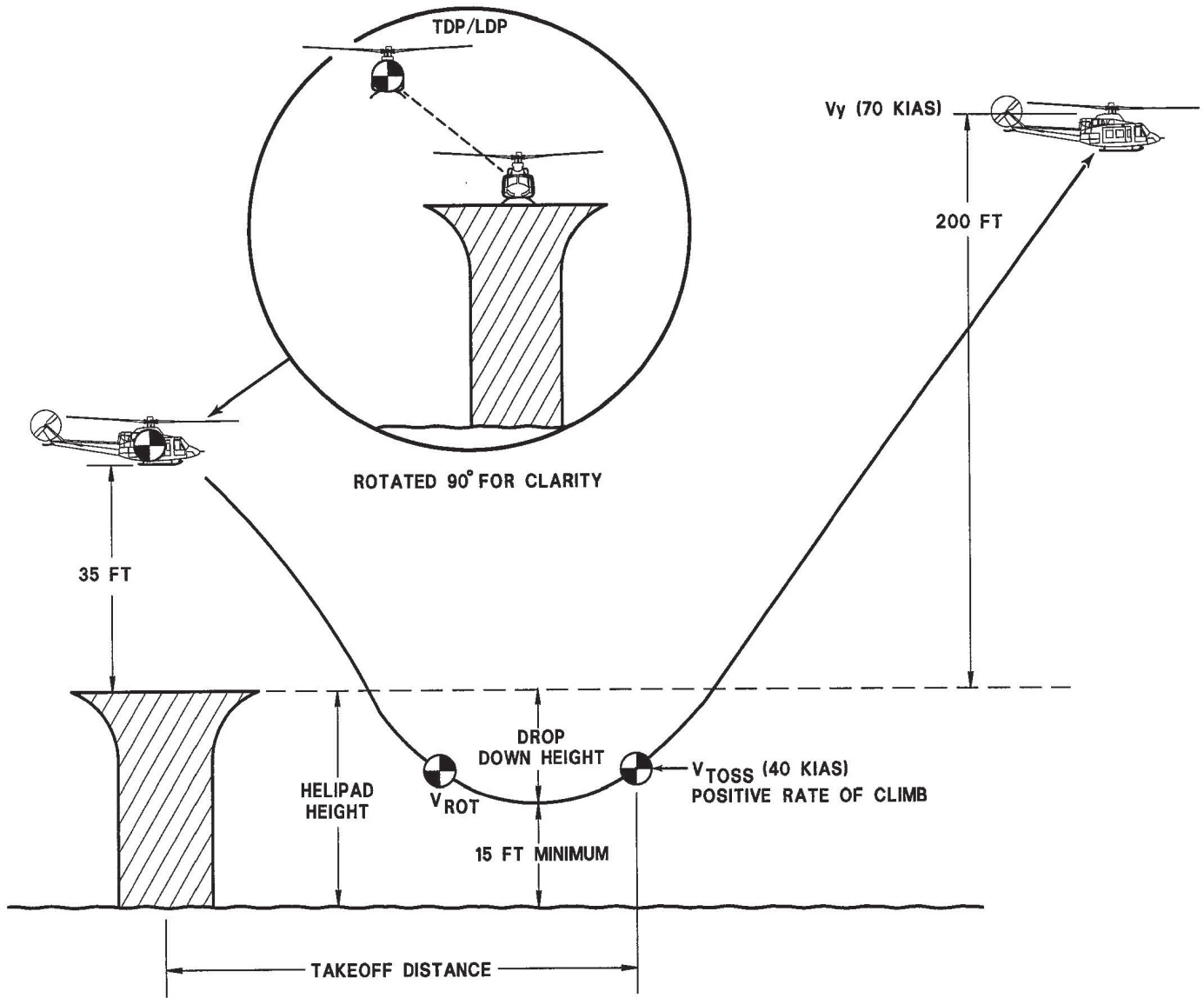

Emergency takeoff or landing (OEI) from elevated platform with one engine inoperative

Helicopter Performance Charts

CATEGORY "A" TAKEOFF AND LANDING LIMIT - SIDE STEP PROFILE

Conditions:

- Elevated helipad (day and night) with at least 105 ft helipad elevation for a 15 ft minimum clearance. Additional performance is available for lower helipads in BHT-412-FMS-62.6 or using the Backup Profile.
- 103% rotor RPM (AEO)

Method:

1. Enter the chart at the pressure altitude of the takeoff / landing helipad
2. Follow the graph line horizontally to the appropriate OAT (outside air temperature) trend line.
3. Follow the graph line vertically to the appropriate gross weight capability with zero headwind.
4. To account for headwind follow the graph line vertically from the zero headwind gross weight down to headwind chart, and follow guideline until appropriate headwind horizontal line is reached.
5. From that point move vertically downward to determine takeoff gross weight capability with unfactored headwind.

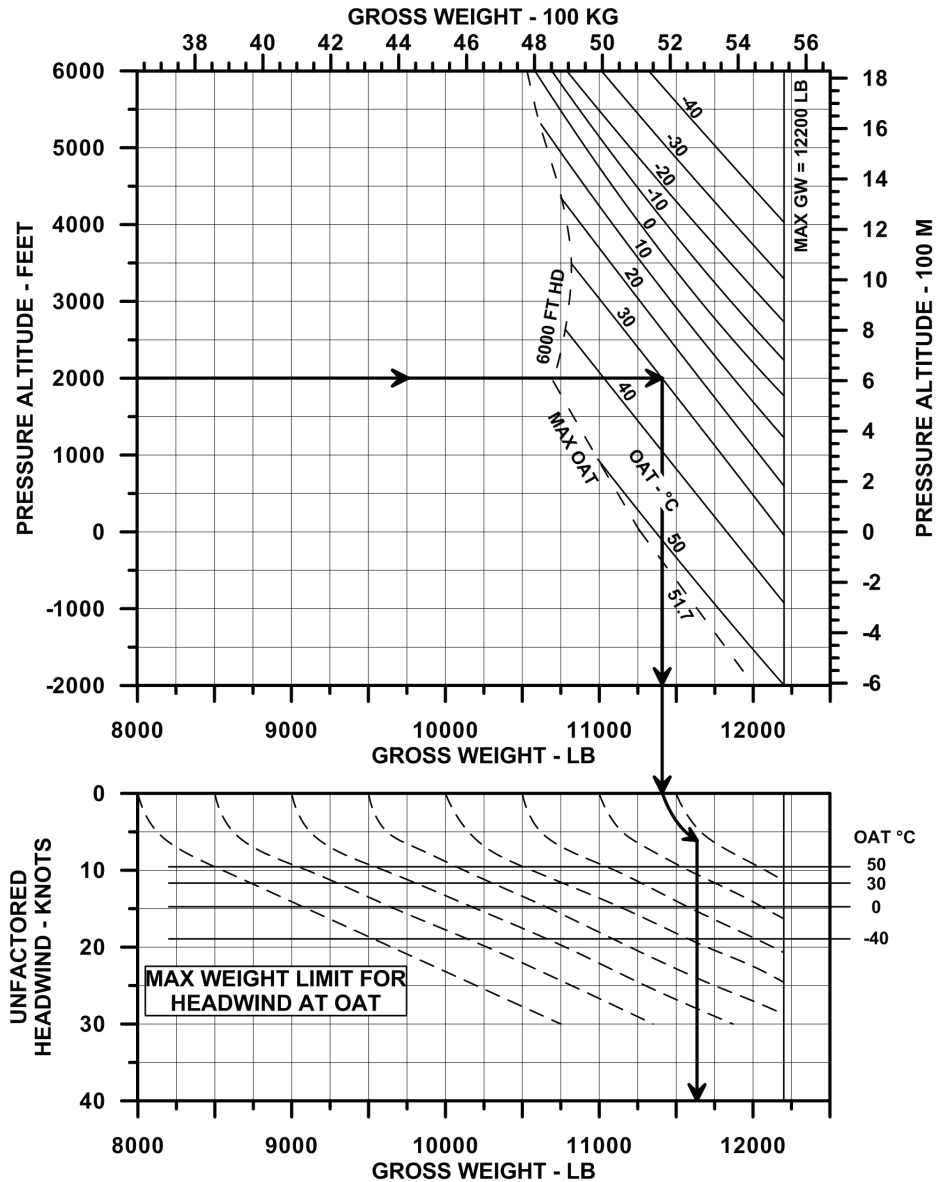

Note: Category A takeoff and landing with the side step profile has not been demonstrated and is not approved above 6,000 ft (1,829 m) density altitude.

Helicopter Performance Charts

CATEGORY “A” NORMAL TAKEOFF AND LANDING - RUNWAY PROFILE

Conditions:

- Normal takeoff (AEO) from runway or short field with all engines operating

RUNWAY PROFILE EXPLANATION

Runway Profile Takeoff (Day and Night)	The takeoff technique is initiated from a 10 ft hover and has a time based TDP that is variable with density altitude. Acceleration to V_{TOSS} (40 kias), with subsequent climb out at V_Y (70 kias), to 1,000 ft.
Runway Profile Landing (Day and Night)	The landing is a normal approach to the runway at V_{TOSS} and less than 500 feet per minute rate of descent.
Runway and Short Field	The Runway profile can be flown to a runway or short field with a minimum runway length of 625 ft (190.5 m). Longer runways may be required at higher density altitudes..

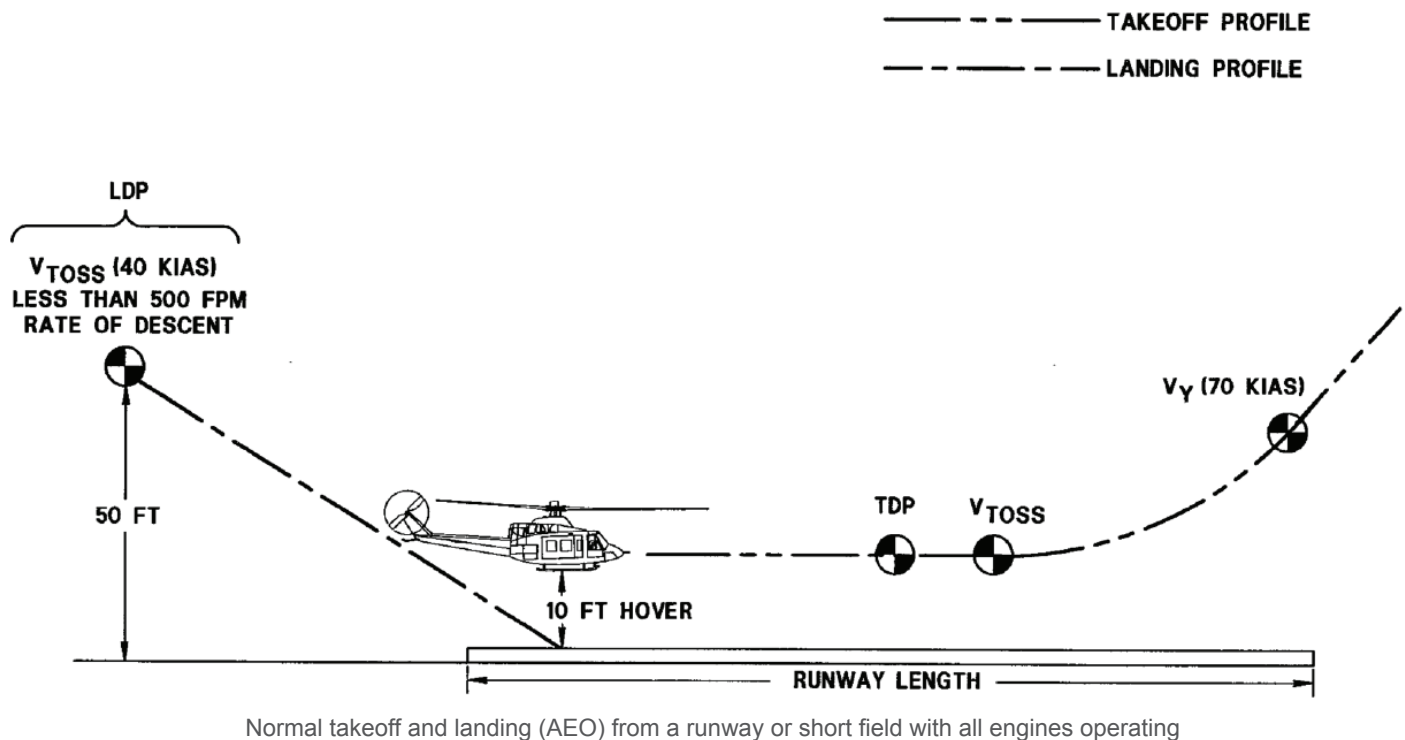

Helicopter Performance Charts

CATEGORY "A" EMERGENCY TAKEOFF AND LANDING - RUNWAY PROFILE

Conditions:

- Emergency takeoff or landing (OEI) from a runway or short field with one engine inoperative
- V_{ROT} = Rotate speed (velocity where airspeed indicator has perceptible motion).

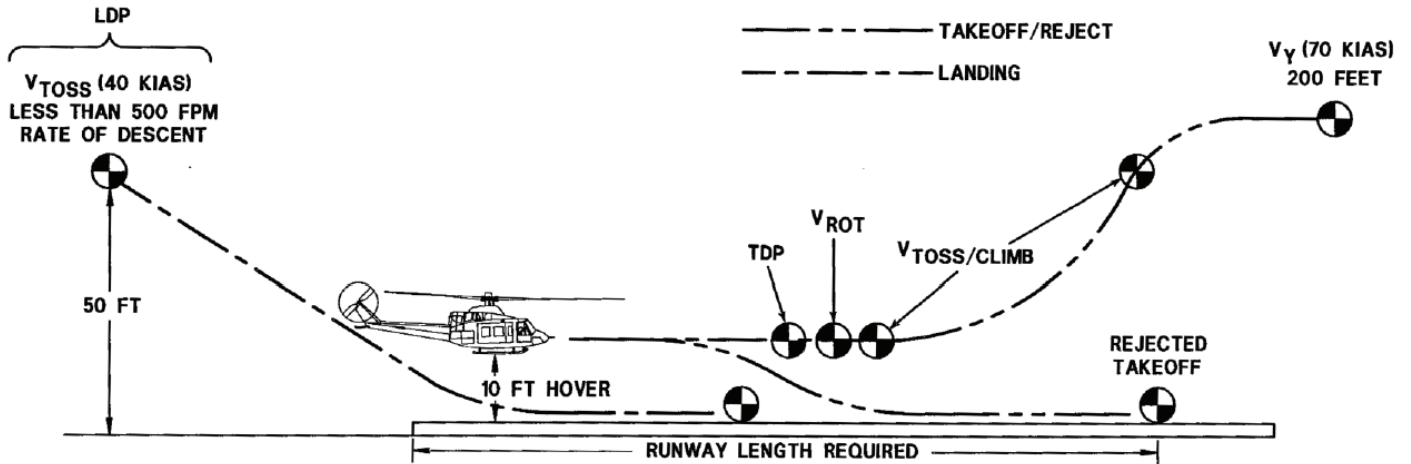

Emergency takeoff and landing (OEI) from a runway or short field with one engines inoperative

Helicopter Performance Charts

CATEGORY "A" TAKEOFF AND LANDING - RUNWAY PROFILE

Conditions:

- Runway or short field (day and night)
- 103% rotor RPM (AEO)

Method:

1. Enter the chart at the pressure altitude of the takeoff / landing runway
2. Follow the graph line horizontally to the appropriate OAT (outside air temperature) trend line.
3. Follow the graph line vertically to the appropriate gross weight capability.

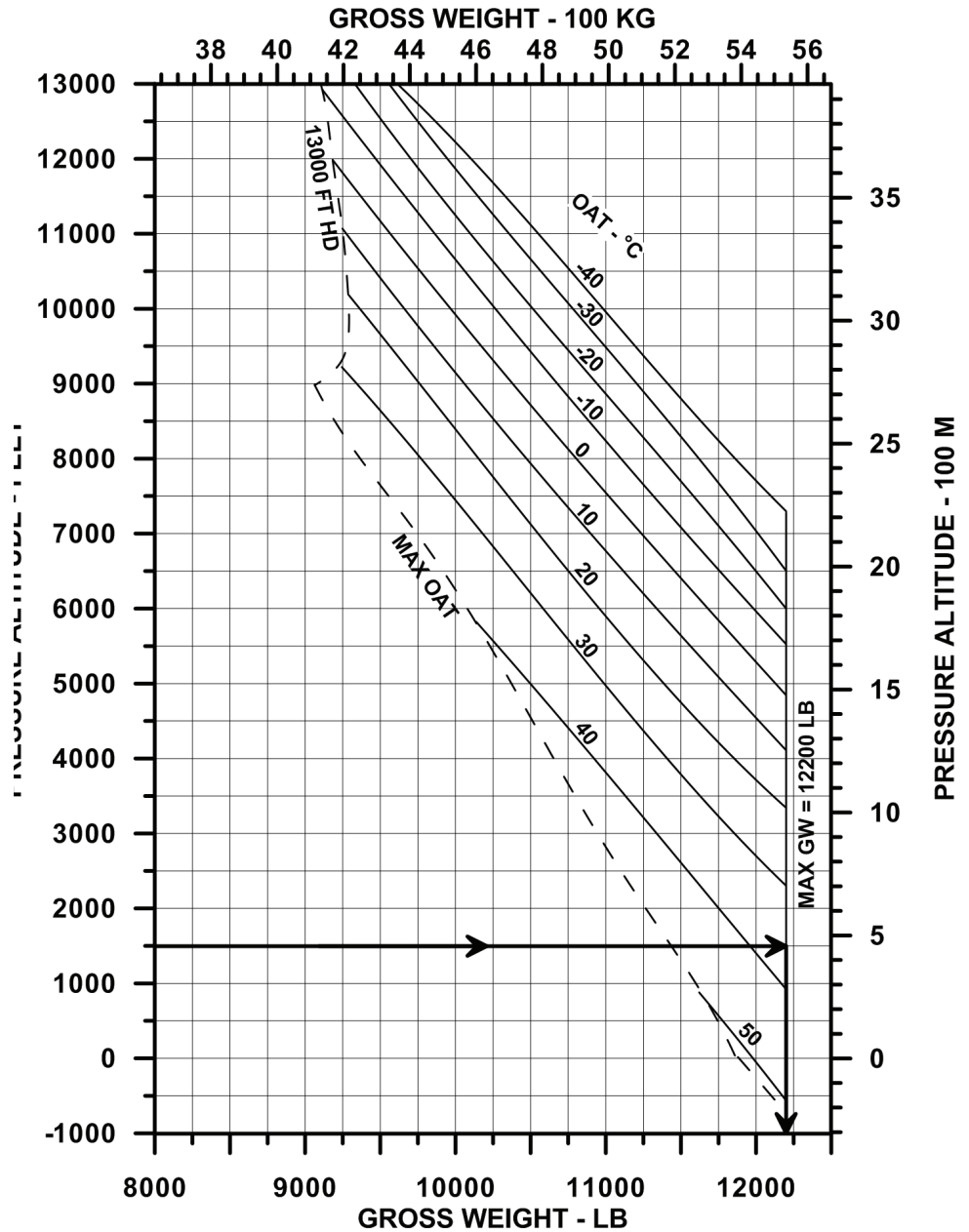

Note: Category A takeoff and landing with the runway profile has not been demonstrated and is not approved above 6,000 ft (1,829 m) density altitude

Fuel Flow vs. Airspeed Charts

Fuel Flow vs. Airspeed chart data based on the following conditions:

- ISA & ISA+20°C
- Pratt & Whitney Canada PT6T-9 engine
- Heater off
- Zero wind
- 100% RPM
- Performance at 97% RPM (AUTO mode) for weights at 11,900 lbs and below is presented in BHT-412-MD-6.
- Note: The best allowable cruise speed is either Long Range Cruise Speed (LRC) or when speed is limited by Maximum Continuous Cruise Power (MCP) or V_{NE} , the maximum speed permitted.



Fuel Flow vs. Airspeed

PRESSURE ALTITUDE = SEA LEVEL, OAT = 15°C (ISA)

Conditions:

- Twin engine operations

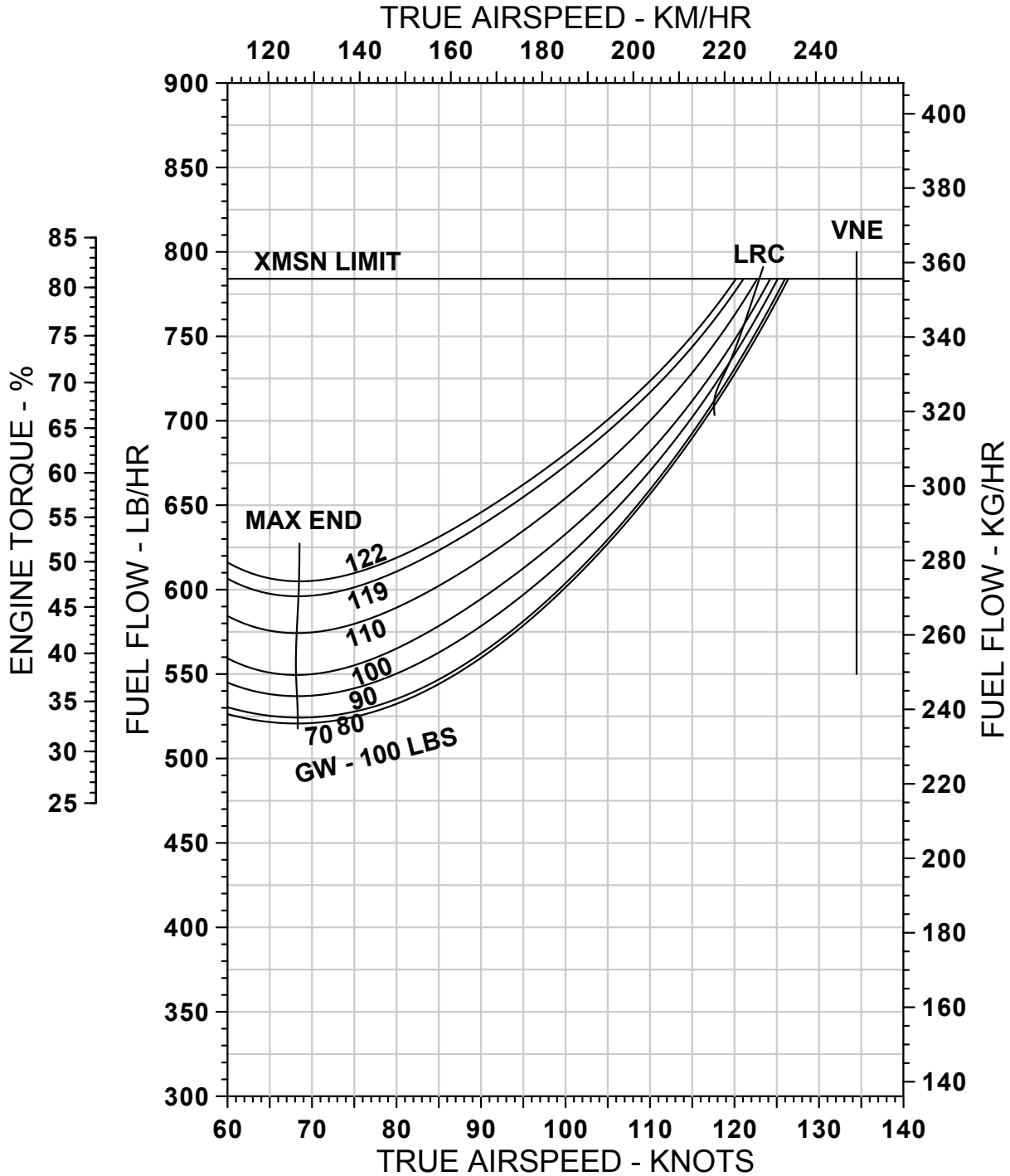

Fuel Flow vs. Airspeed

PRESSURE ALTITUDE = 4,000 FEET, OAT = 7 °C (ISA)

Conditions:

- Twin engine operations

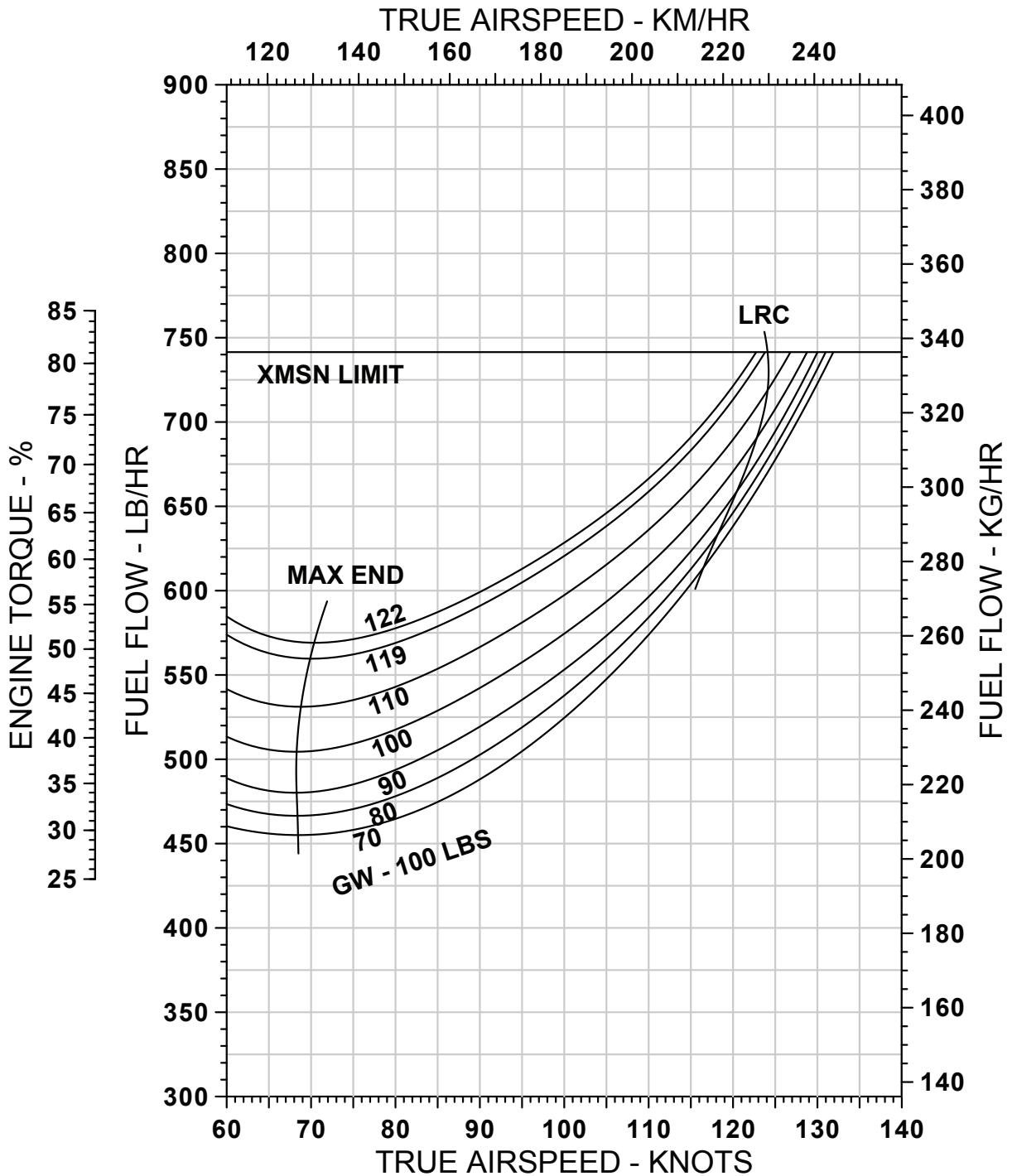

Fuel Flow vs. Airspeed

PRESSURE ALTITUDE = 8,000 FEET, OAT = -1 °C (ISA)

Conditions:

- Twin engine operations

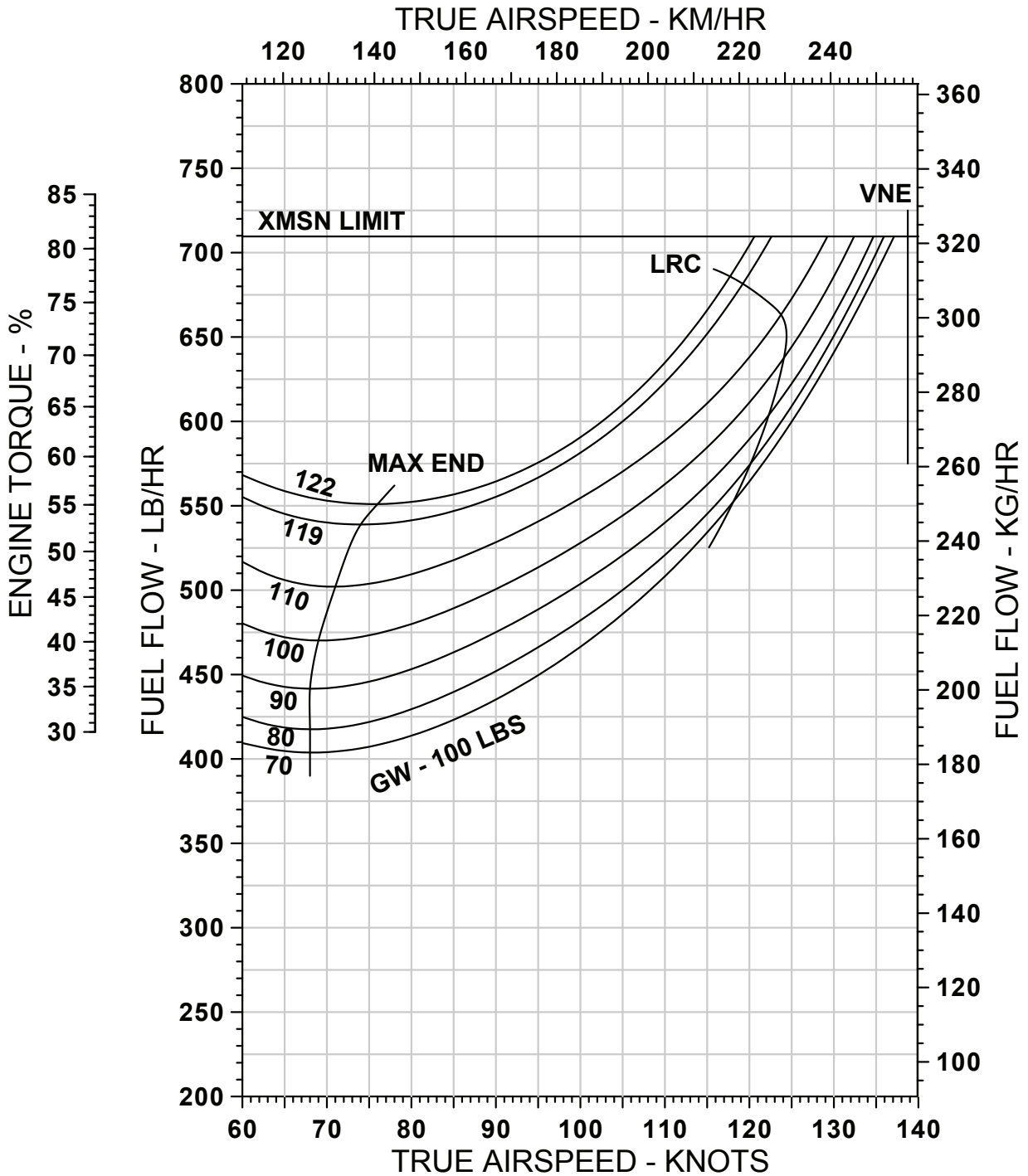

Fuel Flow vs. Airspeed

PRESSURE ALTITUDE = SEA LEVEL, OAT = 35 °C (ISA + 20)

Conditions:

- Twin engine operations

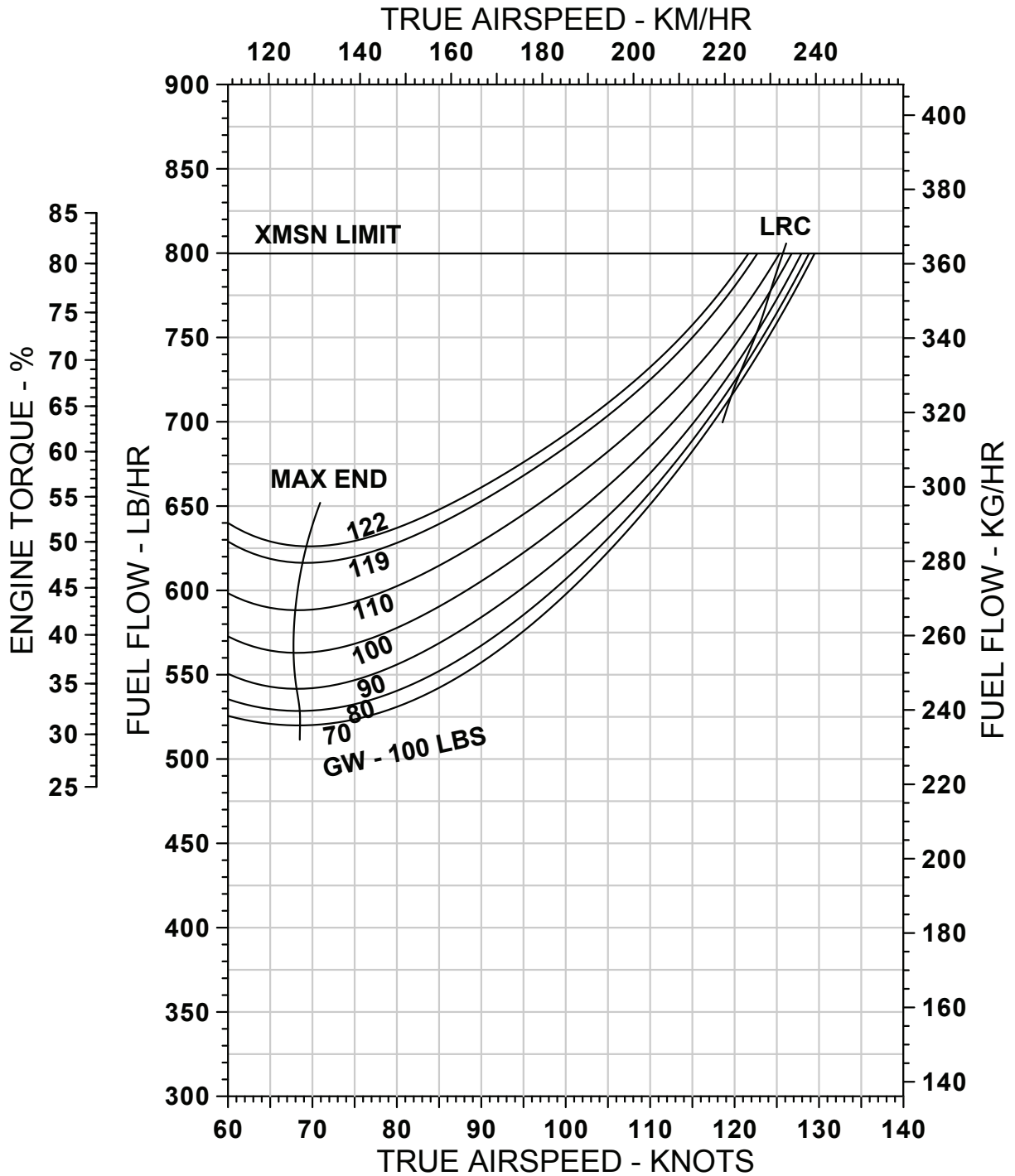

Fuel Flow vs. Airspeed

PRESSURE ALTITUDE = 4,000 FEET, OAT = 27 °C (ISA + 20)

Conditions:

- Twin engine operations

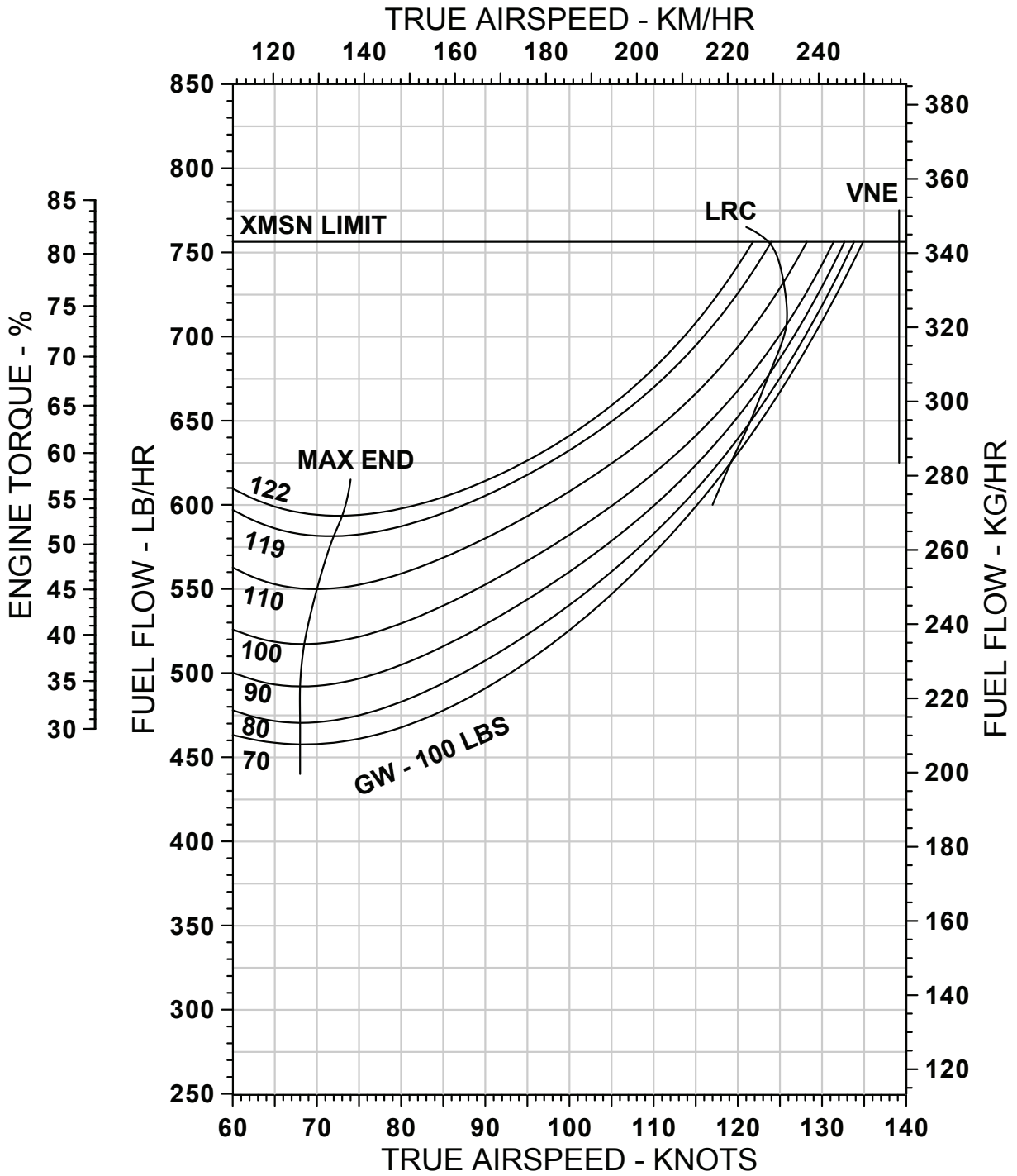

Fuel Flow vs. Airspeed

PRESSURE ALTITUDE = 8,000 FEET, OAT = 19 °C (ISA + 20)

Conditions:

- Twin engine operations

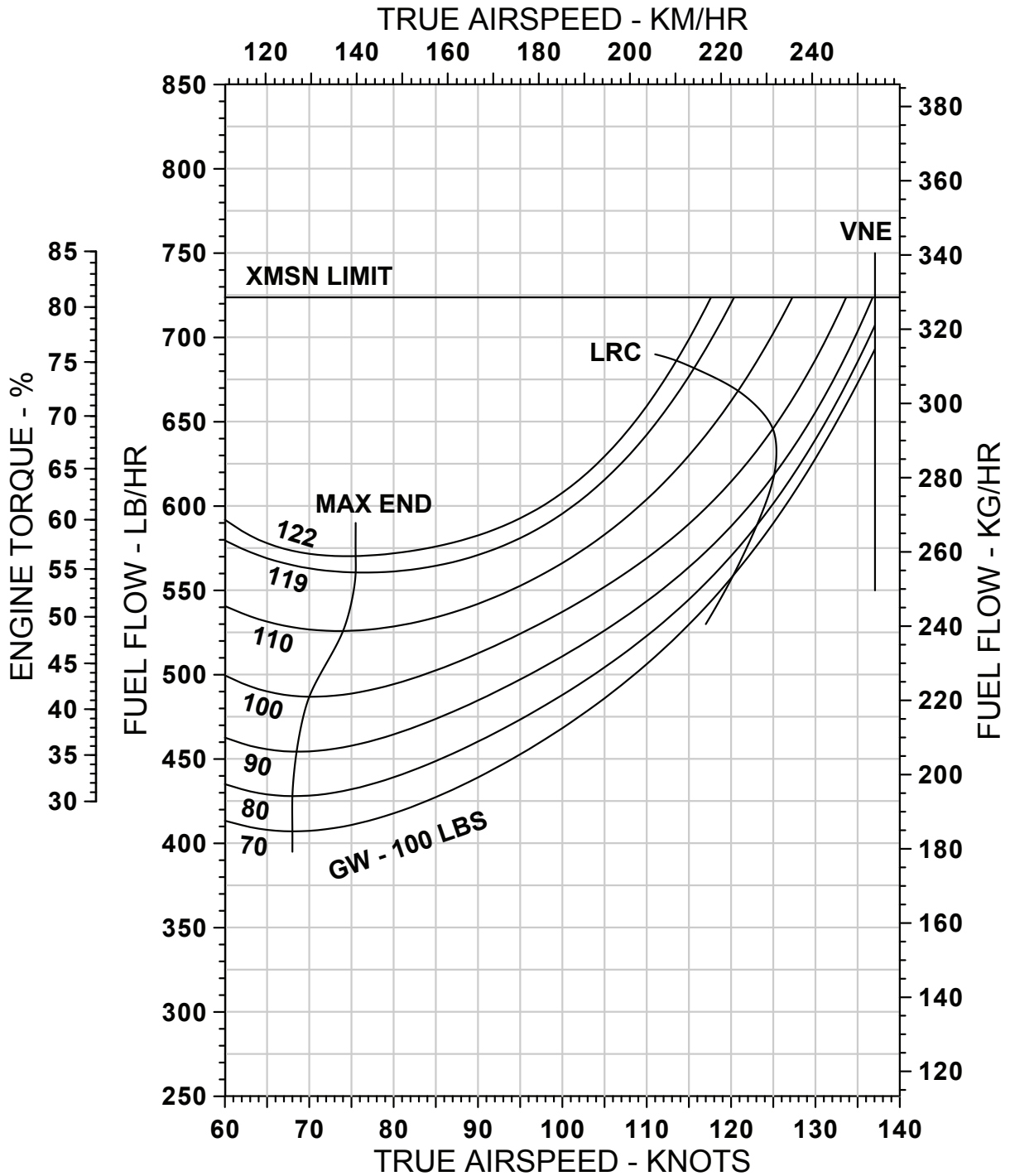

Cost of Operations

INTRODUCTION

Bell Textron Inc. cost of operations data for current production helicopters is based on information from Bell operators and service facilities. BTI’s Product Support organization accumulates cost data from a diverse group of operators - large, small; sub-polar, subtropical; inland, coastal; corporate, charter. This information is analyzed to generate sample data for each production model which are averages of the field experience. BTI intends to continue monitoring actual costs and product improvements to enable annual updates of the data to maintain its currency. The following discussion is provided to review the variables involved in the helicopter’s direct and indirect cost of operations as well as its cost of ownership.

The total cost of helicopter ownership and operation involves both direct and indirect costs. The direct costs are those which are incurred essentially by the flight hour and include:

- Fuel, Lubricants
- Basic Airframe Maintenance
- Powerplant Maintenance

The indirect costs are not directly dependent upon the number of hours flown and include:

- Insurance
- Facilities (hangar, workshop, etc.)
- Crew Compensation
- Financial Factors (depreciation, investment tax credit, financing costs, etc.)

DIRECT COSTS

Fuel, Lubricants	A typical average value of fuel and lubricant costs is included in the sample data provided for each model. Fuel consumption depends upon speed, temperature, externally-mounted accessories, sling loads, etc. A band of approximately 10% more or less than sample value will cover these factors for normal operations. Fuel pricing varies considerably based on where the fuel is purchased geographically and whether it is purchased retail or in bulk. The sample cases use average retail purchase price prevalent at the time of the sample data are prepared.
Basic Airframe Maintenance	<p>Airframe maintenance is divided into four categories:</p> <ul style="list-style-type: none"> • Periodic Inspections • Overhauls • Replacement of Retirement Parts • Unscheduled <p><u>Periodic inspections</u> include those inspection tasks, with their part requirements, listed in the Maintenance Manual for each model. Man hours for periodic inspections can vary from the sample value provided because of differences in personal experience, tool and parts availability, facilities, environmental effects such as extremes in working temperatures. Man hour costs/ hour are also variable among the Authorized Service Centers as a result of differences in local costs, overhead expenses and volume of work. The sample value is an average of costs per hour at Authorized Service Centers at the time of publication.</p>

Cost of Operations

DIRECT COSTS

Basic Airframe Maintenance (continued)	<p><u>Overhauls</u> include removal, disassembly, inspection, parts replacement, reassembly and reinstallation of certain components/assemblies at the periods stated in the BTI Maintenance Manual. Overhaul man hour and parts requirements are subject to considerable variation depending upon the helicopter's operations and environments. The sample data reflect average values.</p> <p><u>Retirement parts</u> are those which are subject to disposal after an operating time stated in the Maintenance Manual. These are normally components of the rotors/control systems which are subject to oscillatory loads and are designed and tested for use over a finite number of flight hours rather than on their condition. The replacement at the required intervals requires some labor which is included in the man hour data in the sample.</p> <p><u>On-condition/Unscheduled maintenance</u> encompasses labor and parts replacement for major maintenance not covered under the formal Maintenance Manual requirements for scheduled part retirements, periodic inspections and overhauls. It also includes those additional maintenance requirements imposed by the manufacturer through issue of Service Bulletins.</p> <p>The sample data for periodic inspections provide for some minor unscheduled maintenance tasks resulting from the inspection.</p>
Powerplant Maintenance	<p>The powerplant (engine) requires periodic inspection and overhauls. The overhaul periods are based on the number of operating hours or on the number of cycles, whichever is the first limit to be attained. Start cycles are a factor because thermal cycles are important in the design of the turbine engine's rotating components. Overhauls are performed by the engine manufacturer and/or at authorized facilities. Powerplant overhaul can be performed for the engine as a unit, or in some cases for individual modules. (Modules can be gearbox, compressor, turbine, for example.) Each module can have its own overhaul period. Modular overhaul can be cost-effective for some operations and its use should be evaluated. Engine or module exchanges can be made in lieu of overhaul. For details, contact the engine manufacturer or his authorized distributors/service centers. The sample costs are based on an average exchange. The powerplant may also require unscheduled maintenance (unscheduled removals for repair, parts replacement).</p>

Cost of Operations

The following table is a sample of the SUBARU BELL 412EPX direct cost of operations, in U.S. dollars per flight hour. This sample is developed by Bell using the *Guide for the Presentation of Helicopter Operating Cost Estimates* published in 2010 by Helicopter Association International.

SAMPLE SUBARU BELL 412EPX DMC (PLUS FUEL ESTIMATE) SUMMARY SCHEDULE

	Parts	Labor ^[1]	Total
AIRFRAME MAINTENANCE			
Scheduled Inspections ^[2]	\$19.62	\$44.18	\$63.80
Scheduled Retirements ^[3]	\$191.10	\$0.38	\$191.48
Scheduled Overhauls ^[4]	\$104.91	\$14.39	\$119.30
Provision for Unscheduled Maintenance and Service Bulletins on above Components	\$32.42	\$2.18	\$34.59
On-condition Maintenance of Other Airframe Components	\$208.62	\$39.15	\$247.77
Subtotal	\$556.67	\$100.27	\$656.94
1.06 Mx Man-Hour / Flt. Hr			
POWERPLANT - PRATT & WHITNEY CANADA PT6T-9 (QUANTITY 2) ^[7]			
Mfr. Estimate of Engine Cost - TBO 5,000 ^[6]			\$456.00
		Subtotal	\$456.00
		Total DMC	\$1,112.94
FUEL AND LUBRICANTS			
Fuel ^[5]			\$452.00
Lubricants			\$4.52
		Subtotal	\$456.52
		Grand Total with Fuel	\$1,569.46

- Notes:
- [1] Labor rate figured at \$95.00 per hour.
 - [2] Based on 600 flight hours / year. 1.5 RIN/FLT HRS
 - [3] Based on 100% Life.
 - [4] Based on 100% TBO.
 - [5] Calculated at 113 GPH at \$4.00 per gallon.
 - [6] Engine estimate assumes utility application, 2 engine cycles per hour, benign environment (no allowance for severe operation, environment or conditional repairs).
 - [7] Includes "2" power sections (5,000 hrs O/H) and "1" combining gearbox (4,000 hrs O/H). Engine estimate assumes utility application, 2 engine cycles per hour, benign environment (no allowance for severe operation, environment or conditional repairs).
 - [8] The costs above were calculated as of 02/2023 and are subject to change.

Other assumptions: Basic helicopter with no optional equipment installed;
Mature helicopter (no warranty considerations);

Cost of Operations

INDIRECT COSTS

Insurance	Insurance rates are based on a number of factors including claim experience, type of operations, and crew qualifications. Rates can be obtained from insurance agent/broker.
Facilities	Facilities can include hangar, workshop, parts storage area, tools, ground support equipment and administrative area as appropriate to the specific operation.
Crew Compensation	The number of aircrew personnel depends on the individual operation; i.e., whether the normal crew consists of one or two pilots, hours per day flown, backup requirements for illness, vacation, etc. Bell regional marketing managers can advise typical local costs for estimation purposes.
Financial Factors	Funding a helicopter purchase can be accomplished in a variety of ways, including cash, short term note, long term note, partnership, etc. For investment accounting, several depreciation methods also exist; straight line, double declining, sum of the years digits, etc. Value of resale is a significant factor.
Miscellaneous Factors	Staff expenses (other than aircrew and direct maintenance personnel), utilities, office expenses, etc.

OWNERSHIP ANALYSIS PROGRAM

Bell uses the most recently published edition of the Life Cycle Cost computer program provided by Conklin & de Decker Associates, Inc. to determine total ownership costs for an operators planned period of utilization for the aircraft. To request a Life Cycle Cost Analysis, please contact your sales representative or call 1-800-FLY-BELL (1-800-359-2355).

Component Overhaul

COMPONENT OVERHAUL INTERVALS

Component	Hours	Component	Hours	Component	Hours
Collective Lever	2,500	Main Drive Shaft	3,000	Transmission	6,000
Driveshaft Couplings (2)	5,000	M/R Pitch Links (4 ea)	2,500	T/R Driveshaft Hangar	5,000
Hub & Sleeve Assy	2,500	Rotor Brake Quill	3,000	T/R Hub Assembly	2,500
Hydraulic Actuator (3)	2,500	Starter Generator (2)	1,000	T/R Gearbox	5,000
Intermediate Gearbox	5,000	Swashplate & Support	2,500		
Mast Assembly	6,000				

Limited Life Components

Part Number	Component	Life in Flight Hours	Life in RIN	Qty Per Aircraft
MAIN ROTOR COMPONENT				
412-010-101-139	Yoke Assembly	3,000		2
412-010-190-105	Spindle	10,000		4
412-010-149-111	Pitch Horn	15,000		4
412-010-124-109	Retention Bolt	5,000		4
412-010-137-103	Retention Bolt	5,000		4
412-010-185-109	Damper Bridge, Upper	15,000		4
412-010-111-103	Fitting	5,000		4
412-010-170-105	Damper Bridge, Lower	10,000		4
MAIN ROTOR CONTROLS				
412-010-403-117	Rephasing Lever Assy	5,000		2
412-010-405-111	Drive Link Assy	5,000		2
412-010-407-117	Swashplate Outer Ring	10,000		1
412-010-453-105	Swashplate Support Assy	15,000		1
212-010-416-101	Gimbal Ring Assy	9,000	1	1
212-011-412-101	Collective Sleeve	9,000	1	1
412-010-465-101	Collective Lever Pin	20,000	2	1
412-010-464-101	Collective Lever Assy	20,000		1
PROPULSION and DRIVE SYSTEM				
412-040-114-101	Main Rotor Mast ^[1]	2,500	25,000	1
412-010-171-103	Cap Retention [2]	10,000	1	1
412-010-165-101	Cone [2]	10,000	1	1
412-010-166-101	Drive Pin [2]	10,000	8	8
412-010-286-101	Upper Cone Seat	2,500		1
412-010-277-101	Splined Plate Assy [1]	2,500	25,000	1
412-010-056-101	Lower Cone Seat	2,500		1
412-010-179-105	Cone [2]	10,000		1
TAIL ROTOR CONTROLS				
212-011-702-001	Tail Rotor Yoke	5,000		1
412-016-100-111	Tail Rotor Blade	5,000		2

Limited Life Components

LIMITED LIFE COMPONENTS (continued)

Part Number	Component	Life in Flight Hours	Life in RIN	Qty Per Aircraft
OTHER				
412-704-112-105	Bolt Kit	2,500		1
EWB0420D-7-36	Bracket Bolt	15,000		16
20-057-5-24D	Bolt	2,500		3

- Notes:
- (1) Mast and spline plate has a retirement life of 2,500 hours or 25,000 RIN, whichever occurs first. Assuming ten torque events per hour, an operator would retire the mast and spline plate due to the RIN limitation. The cost per hour therefore, is based on RIN not flight hours.
 - (2) A one-time 7,500 hour penalty for all aircraft with serial numbers 38001 – 38999 and 39101 – 39999 on retention cap, cones, and drive pins.
 - (3) Overhaul and life-limited components information for reference only. Refer to MM for specific requirements.

Global Customer Solutions

As the industry leader in customer support, we at Bell pride ourselves on supporting our customers around the world at every step of your aircraft's life cycle. We are committed to providing customers with an extensive range of support and service capabilities to ensure safe and reliable operation of our products, enhance mission execution, and keep you flying.



SUPPORT AND SERVICE OFFERINGS

3

Straightforward Customer Advantage Plans (CAP) covering basic aircraft configuration with optional coverage for non-standard kits

4,000

Parts offered through the Aeronautical Accessories brand

and

11

Bell service centers around the world with wide ranging maintenance, repair and overhaul capabilities

1,200

Unique Supplemental Type Certificates (STCs), all of which comply with FAA regulations and meet rigorous internal quality standards

3

Bell Training Academy locations around the world with expert instructors who offer industry-leading pilot and technical training

85

Network Service Partners with the ability to perform a wide range of aircraft services

Global Customer Solutions

CUSTOMER ADVANTAGE PLANS (CAP)

CAP safeguards your direct maintenance costs and provide the ultimate in cost predictability. The plans protect your investment and provide confidence of knowing you're backed by the industry leader in customer support. With coverage options for non-standard kits, our customers experience the Bell Advantage.

SIMPLE COMPREHENSIVE PLANS

Bell offers simple CAP options: Standard, Select, and Premier.

Each offers holistic coverage of the standard helicopter configuration, with some plans featuring optional coverage for non-standard kits. CAP plans are designed to provide peace-of-mind that your aircraft is protected from day one.

Peace of Mind



DMC competitive



Residual value protection



Optional non-standard kit coverage



Improved financing terms



Reduced part replacement and repair time



Streamlined budgeting



Fleet customers may be eligible for no 'Buy-Ins'

PREMIER ACCESS TO INCREASE AIRCRAFT AVAILABILITY

CAP members have preferred access to Bell's dedicated rotatable pool of parts. This inventory reduces traditional repair or replace turnaround times.

**Upon sale of aircraft, any remaining funds in the aircraft's Premier CAP account may be transferred with execution of new contract.*

Global Customer Solutions

CAP FEATURES

		Premier	Select	Standard
Typical Customer	Expected aircraft ownership period	10+	5+	5
	Annual flight hours	300+	200+	<200
	Aircraft age	Any	Any	New
Coverage	Standard helicopter configuration parts	<input checked="" type="checkbox"/>	<input checked="" type="checkbox"/>	<input checked="" type="checkbox"/>
	Optional coverage for kits installed by Bell	Available	Available	<input checked="" type="checkbox"/>
	Parts used for scheduled maintenance	<input checked="" type="checkbox"/>	<input checked="" type="checkbox"/>	
	Parts used for unscheduled maintenance	<input checked="" type="checkbox"/>	<input checked="" type="checkbox"/>	<input checked="" type="checkbox"/>
	Life-limited components	<input checked="" type="checkbox"/>	<input checked="" type="checkbox"/>	
	Overhauls	<input checked="" type="checkbox"/>	<input checked="" type="checkbox"/>	
Contract	Minimum annual flight hours	No minimum	Negotiated	No minimum
	Renewable	<input checked="" type="checkbox"/>	<input checked="" type="checkbox"/>	
	Transferable	<input checked="" type="checkbox"/> *		<input checked="" type="checkbox"/>
	Term length (years)	5	5	5
	Term length (flight hours)	Unlimited	Negotiated	Unlimited
	Payment terms	By flight hour	Negotiated	By flight hour

* Upon sale of aircraft, any remaining funds in the aircraft's Premier CAP account may be transferred with execution of a new contract.

NEW AIRCRAFT COVERAGE

CAP provides the confidence of knowing you're backed by the industry leader in customer support. For new aircraft, the plans are designed to provide peace-of-mind that your aircraft is protected from day one of your aircraft ownership.

KEY BENEFITS



LOWER RATES
DURING WARRANTY



SAVINGS ON OVERALL AIRCRAFT
SUPPORT



RESIDUAL VALUE
PROTECTION ON AIRCRAFT

To learn more about how CAP can assist you with your aircraft operations, please contact CAP@bellflight.com or contact your Bell Sales Representative.

Global Customer Solutions

SERVICE CENTERS

Bell’s Global Customer Solutions provides customers with a complete and seamless support system offering a full service experience anywhere in the world.

With a suite of available services including aircraft customizing, maintenance repair and overhaul, and Bell warranty work, our service centers offer direct OEM support in every corner of the world.

		Piney Flats, TN	Miami, FL	Singapore	Prague	China	Mirabel, Canada	Broussard Blades	Broussard Composite Panels	RBI Hawker (UAE)	RBI Hawker (Australia)	RBL (United Kingdom)	Australia
Component Repair & Overhaul Capabilities	Expanded repair	●	●	●	●	●	▲						▲
	Transmission	●	●	●	●	▲	▲						●
	Hubs	●	●	●	●	▲	▲						●
	Avionics	●	▲	▲	●	●	▲						▲
	Rotor blades	▲	▲	▲	▲	▲	▲	●		●	●	●	▲
	Composite panels	▲	▲	▲	▲	▲	●		●				▲
Additional Capabilities	Aircraft customizing	●	▲	●	●	●	●						●
	Retrofits, modifications & upgrades	●	●	●	●	●	●						●
	Approved installer of Aeronautical Accessories parts & accessories	●	●	●	●	●	●						●
	Aircraft Paint Services	●	▲	●	●		●						●
	Field maintenance & repair (Remote)	●	●	●	●	●	●	●		●		●	●
	Bell warranty work	●	●	●	●	●	●	●	●	●	●	●	●
	Engine support & rental program		▲	▲		▲							▲

- In-House Capabilities
- ▲ Outside Services

For more information on each facility visit: bell.co/MRO

Global Customer Solutions

CUSTOMER SERVICE FACILITIES (CSF)

In addition to our 11 service centers, Bell has a strong network of more than 80 Authorized Customer Service Facilities (CSFs). These award-winning facilities enhance the accessibility of in-region global support and ensure that your aircraft is ready whenever and wherever you need it.

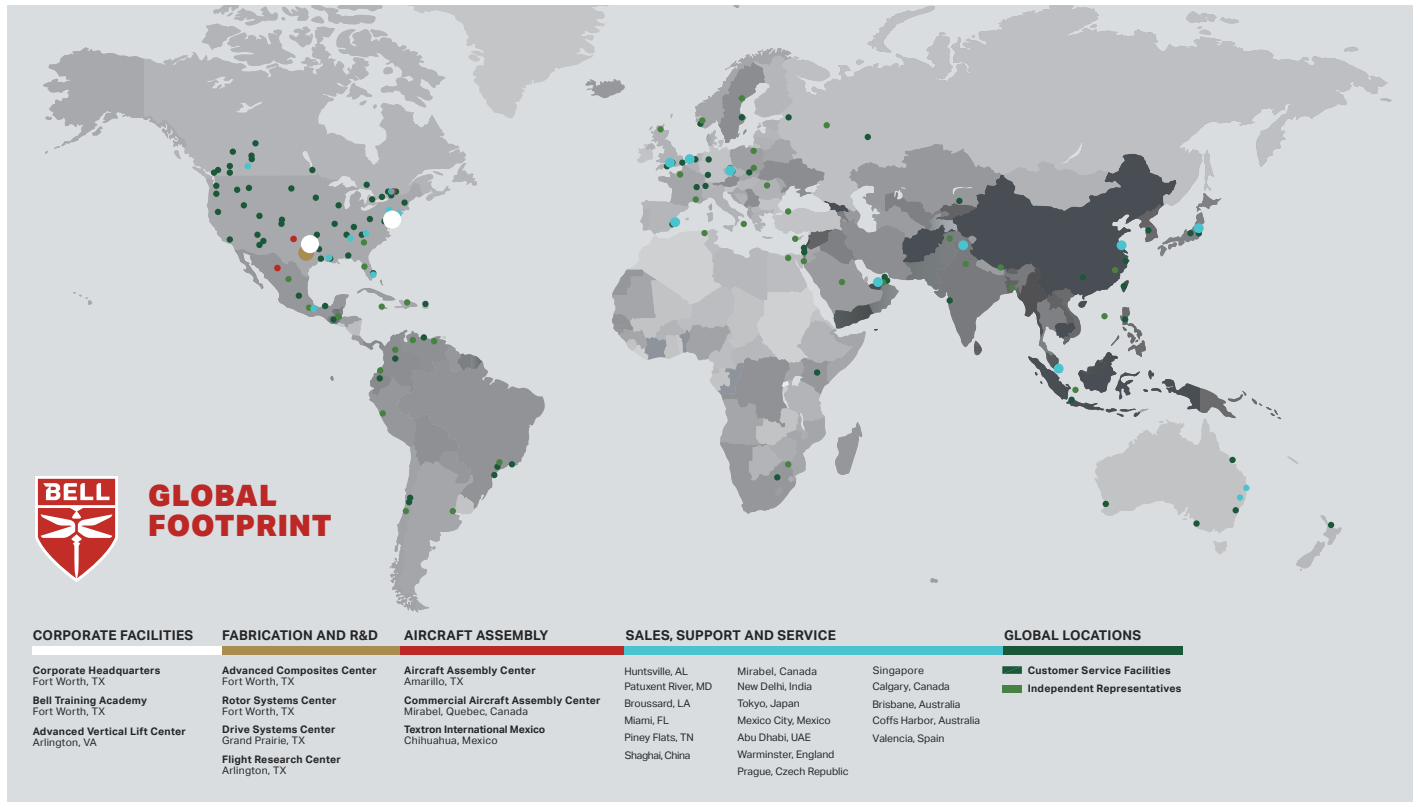

QUALITY ASSURED AND OEM APPROVED

Customers who choose an authorized CSF for maintenance, repair and overhaul work can be assured that both the staff members and the facility itself meet Bell's stringent internal standards for quality and safety. Authorized CSFs have factory-trained maintenance technicians and are equipped with the skills and expertise required to process Bell warranty claims. In addition, these facilities maintain guaranteed parts inventories to service aircraft and possess the most up-to-date technical and safety information available. All of this combines to provide in-region support you can trust.

Training

BELL TRAINING ACADEMY (BTA)

BellFlight.com/Training

Bell's global training solutions are designed to equip customers with the knowledge and skills necessary to safely and efficiently perform their missions. Since 1946, the BTA has been committed to providing industry leading training programs that create better, safer flight operations. The BTA staff of highly skilled professional pilot and technical instructors leverages OEM data and expertise to deliver the finest helicopter training in the world. We continue to develop innovative programs that will take our customers' pilot and technical skills to a whole new level.



The BTA at Bell's headquarters in Fort Worth, Texas.

Each purchase of a new aircraft comes with a customized complementary training solution. Supplemental training courses are available at an additional cost.

STATE-OF-THE-ART TRAINING RESOURCES

Based at the Bell headquarters in Fort Worth, Texas, the BTA combines a track record of excellence with a wide variety of industry-leading amenities.



#1

Pilot and maintenance training consistently ranked #1 in the industry



375+

Years combined experience among Bell's technical instructors



25,000+

Square foot maintenance hangar



7,500

Average instructor pilot flight hours



200,000+

Pilot and maintenance technicians trained



134+

Countries represented by customers in every market segment



3

Full Flight Simulators (FFS) for the Bell 407GX, Bell 525 in Fort Worth, Texas, and a FFS for the Bell 429 in Valencia, Spain



6

Advanced Flight Training Devices (FTD) designed to train on seven models

Training

The BTA's 80+ staff members welcome students from all over the world, and are eager to share the knowledge gained from decades of hands-on experience within the military and across other professions. Instruction can be provided in English or Spanish. Students are responsible for translation services if needed.

Recognized by the European Aviation Safety Agency (EASA) as an Approved Training Organization (ATO), the BTA has the authorization to provide Part-FCL type specific flight training courses to EASA regulated customers for the 407, 412, 429, and 505 models, including the use of Flight Training Devices (FTD) for the Bell 407, Bell 429 and 505 models. A Performance Based Navigation (PBN) Generic Non-Type or 412/429 Type Rating Specific courses are also approved.

The BTA is also authorized by various international regulatory agencies for type-specific technical training of engineers / mechanics. These agencies include the Civil Aviation Authority of Singapore (CAAS), Transport Canada (TC), European Aviation Safety Agency (EASA), Australian Civil Aviation Safety Authority (CASA), Civil Aviation Administration of China (CAAC), Director General Civil Aviation of India (DGCA), and the UAE General Civil Aviation Authority (GCAA).

GLOBAL TRAINING NETWORK

With nearly 70 percent of our commercial aircraft delivered internationally, Bell understands the need for training to be readily available where our customers perform their missions. Our training centers are equipped and certified to meet the needs of our customers around the globe. We are committed to having resources where our customers operate and are investing to provide world-class, global training solutions to meet a growing customer demand.

Singapore: BTA Singapore is approved by the Civil Aviation Authority of Singapore (CAAS), European Aviation Safety Agency (EASA), Australian Civil Aviation Safety Authority (CASA), and Director General Civil Aviation of India (DGCA), and the UAE General Civil Aviation Authority (GCAA). BTA Singapore offers regulatory classes for maintenance theory and practical training on all current Bell models and select legacy aircraft. Available courses include avionics maintenance, field maintenance and refresher courses, cable and connector training, and vibration monitoring system training.

Europe: All pilot training classes at BTA – Valencia, are instructed upon the Bell 429 EASA-certified Level D Full Flight Simulator (FFS). The Bell 429 FFS offers the largest standard visual field of view and the largest standard dome radius of any simulator on the market today. Additionally the FFS offers industry-leading motion performance with high-fidelity superior accelerations, smoothness, and responsiveness powered by REALFEEL® Control Loading System and REALVibe™ Secondary Cueing System.

BTA, Valencia, offers three courses with plans for additional class offerings in the coming years. BTA-Valencia offers a 10-day Bell 429 EASA initial type rating and a Bell 429 recurrent course to reinforce the initial type rating. Additionally, BTA-Valencia offers wet and dry leasing that is custom tailored to each operator. For more information on wet and dry leasing please visit www.bellflight.com/training.



Maintenance training at BTA Singapore

Training

GENERAL INFORMATION

The operator and maintenance training provided by BTA establishes a foundation that supports mission tasks with aircraft pilot qualification.

Pilot Operator Training: Our pilot training program includes basic academics and initial flight training to transition current pilots into Bell aircraft. All training is conducted by certified Bell instructor pilots.

Maintenance Technician Training: Experience is important, however, instruction received in the classroom and training lab provides an undeniable enhancement. Facilitating more efficient maintenance manpower and improving logistics supportability ensures that the customer's Bell is operational and maintainable in all types of climate and terrain.

Academic training includes both state-of-the-art instructor-led computer presentations and hands-on maintenance training. Mechanical, electrical, and avionics training takes place in a temperature controlled shop and will include use of composite maintenance trainers and avionics bench trainers. The BTA also has operational cutaway mockups, a composite repair room, and an electrical/avionics lab. Over half of the maintenance training is hands-on, skill enhancing, and performance focused instruction. Training is determined complete, as defined by Bell, after each student demonstrates an ability to perform to the course standards for actual maintenance and operation of the equipment referencing technical manuals.

Training Aircraft: The BTA conducts flight training in Bell OEM-owned or newly delivered customer aircraft.

Training Materials and Language: Bell provides each maintenance and pilot training candidate a hard-copy course notebook in the English language for each course conducted by BTA instructor personnel. The training materials will be sufficient to train maintenance technicians and pilots who meet the course prerequisites in the maintenance and operation of the applicable model helicopters. Course instructional electronic media, syllabi, course outlines, and company intellectual property will be considered non-deliverables.

Training Technology: Bell is leading the industry in its use of engineering technology to more effectively teach pilots and maintainers around the world. The use of 3-D, high-fidelity, interactive graphics provide students an authentic representation of each component. Unity courseware allows instructors to manipulate the models to see individual parts and systems in detail without leaving the classroom. This type of training engages students and improves retention..

Student Registration: The customer is responsible for submitting an enrollment request for each training candidate via Bell's on-line registration process at www.bellflight.com/training. It is encouraged that all training be scheduled at least ninety (90) days prior to the start of each established course date to ensure space and instructor availability.

Cancellation Policy: The customer agrees to comply with the BTA cancellation policy as set forth at www.bellflight.com/training.



Training

GENERAL INFORMATION (CONT.)

Trainee Visas: Applying for and receiving a visa for students in a timely manner is the responsibility of the customer. To ensure timely approvals, students must register early.

Trainee Expenses: Arrangements and expenses associated with training, including but not limited to, air travel, ground transportation (car rental/taxi), meals, and lodging for each designated trainee will be the responsibility of the customer.

TRAINING COURSES

The following table summarizes both the pilot and maintenance training course offerings for the SUBARU BELL 412EPX and others in the 412 series. Additional training options are available at bellflight.com/training.

SUBARU BELL 412EPX TRAINING COURSE SUMMARY

Course	Duration
Pilot Training	
Bell 412EPX Ground and Flight Procedures Initial Course*	2 weeks
Bell 412EPX Ground and Flight Procedures Refresher Course*	2 days
Bell 412EPI Ground and Flight Procedures Initial Course*	2 weeks
Bell 412EPI Ground and Flight Procedures Refresher Course*	2 days
Left Seat Orientation*	2 days
Maintenance Training	
Bell 412 Series (P&W PT6T) Field Maintenance	3 weeks
Bell 412 (P&W PT6T) B1.3	4 weeks
Bell 412 (P&W PT6T) MEII	4 weeks
Bell 412 (P&W PT6T) Field Maintenance (Experienced)	2 weeks
Bell 412 EPI & EPX (P&W PT6T) Maintenance Differences	3 days
Bell 412 (P&W PT6T) Field Maintenance Refresher	3 days
Bell 412 Component Overhaul	3 weeks
Bell 412 Electrical Maintenance	1 week
Bell 412 B2	4 weeks
Bell 412 AVII	4 weeks
Bell 412 Avionics Maintenance	1 week
Bell 412 SPZ-7600 Digital (3-Axis) AFCS Maintenance	1 week
Bell 412 SPZ-7600 Digital (4-Axis) AFCS Maintenance	7 days
Bell 412 SPZ-7600 Digital (4-Axis SAR) AFCS Maintenance	2 weeks
Bell 412 EPI & EPX Avionics Maintenance Differences	1 week

* May require customer aircraft.

COURSE DESCRIPTIONS

Please visit our website at bellflight.com/training for complete course descriptions.



Our Aeronautical Accessories brand offers more than 4,000 parts and 1,200 unique supplemental type certificates (STCs), allowing you to upgrade your aircraft to meet the latest mission requirements.

With a broad selection of competitively priced, proven replacement parts and accessories, Aeronautical Accessories also features outstanding customer service that has been rated the best in the rotorcraft aftermarket.

INNOVATION RELIABILITY & PERFORMANCE

Aeronautical Accessories is dedicated to listening to the voice of the customer in developing new products, focusing on the safety for your passengers and crew, and providing an uncompromising emphasis on quality. Our components meet FAA requirements as well as exacting internal standards and are backed by an exceptional warranty—a benefit of being part of Bell. Aeronautical Accessories is also registered under Bell as a certified ISO 9001 with AS9100 Revision D facility.



GLOBAL AVAILABILITY OF PRODUCTS

Through our global distribution and modern inventory management system, we minimize customer downtime for repairs, refurbishments and completions. Whether you are looking for new landing gear components, a specialty window or replacement interior plastic panels, Aeronautical Accessories has these in-demand items as part of our core product offering. We also can assist your needs with the latest developments in safety and mission equipment – featuring several new products that can take your aircraft to that next level. Our options such as enhanced doors and seating can make those long flights seem shorter, and the extensive choices for specialized lighting are sure to assist in all your flights that take place at night. Aeronautical Accessories' growing product line also features important items such as fuel filtration, floats for missions that occur over water, as well as the best solutions available in ground handling equipment.



WE ARE HERE TO HELP

Whether you are customizing your new aircraft, looking to improve your ship's capabilities, or repurposing your helicopter, Aeronautical Accessories is available to assist. Visit our website www.aero-access.com and learn about all the products we offer. You may also send an email to sales@aero-access.com to reach our Sales & Support team or give them a call at 800.251.7094.



BELL 412 FEATURED PRODUCTS

Bell 412 Health and Usage Monitoring System (HUMS) Kit

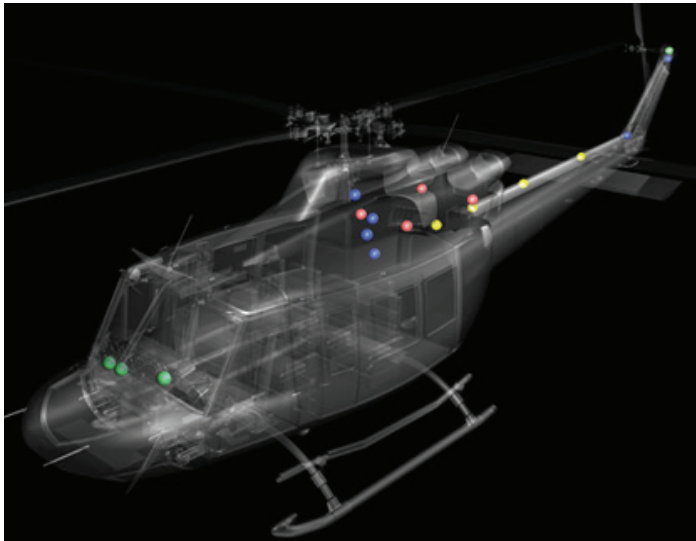

- Provide drive train health and engine monitoring to improve aircraft serviceability and maintainability between regularly scheduled inspections and overhaul periods
- Control head located in the pedestal provides the primary flight crew interface
- Pedestal mounted USB port allows the flight crew to transfer data between the aircraft and a PC-based ground support station
- Ethernet connection provides means for maintenance personnel to connect to the ground support station
- Diagnostics facilitate vibration-related maintenance functions such as main rotor track and balance, tail rotor balancing, main input drive shaft balancing and tuning of the instrument panel Frahm absorber
- Enhanced vibration diagnostics allow maintenance personnel to detect faults within the main rotor system, tail rotor drive system, engine accessory gearbox and combining gearbox
- Built-in test features simplify system troubleshooting

Cockpit Voice and Flight Data Recorder



- “On-condition,” line-replaceable unit that simultaneously records both cockpit voice and flight data
- Capable of recording a minimum of 25 hours of flight data and two hours of audio, and audio inputs are provided from four separate channels
- Simultaneously records all four channels, converts the audio into a digital format and stores the data in solid-state memory
- Flight data is recorded in flash memory and segregated from the cockpit voice data, and can be downloaded to ground station equipment in approximately five minutes
- Ground support equipment interface connector is provided and easily accessible
- Pedestal-mounted cockpit control unit easily accessible

BELLFLIGHT.COM

© 2023 Bell Textron Inc. All registered trademarks are the property of their respective owners. The information herein is general in nature and may vary with conditions. Individuals using this information must exercise their independent judgment in evaluating product selection and determining product appropriateness for their particular purpose and requirements. For performance data and operating limitations for any specific mission, reference must be made to the approved flight manual. CML_Subaru-Bell-412EPX_SPCP_8.5x11in_230301_R00_FINAL