

# New Avenues for Research and Development of Electric Propulsion Thrusters at SSL

IEPC-2017-400

*Presented at the 35th International Electric Propulsion Conference  
Georgia Institute of Technology • Atlanta, Georgia • USA  
October 8 – 12, 2017*

Ian K. Johnson<sup>1</sup>, Ewan Kay<sup>2</sup>, Ty Lee<sup>3</sup>, Ryan Bae<sup>4</sup>, and Negar Feher<sup>5</sup>  
*Space Systems Loral, Palo Alto, CA 94303*

Currently in its 5<sup>th</sup> decade, SSL is one of the world's leading satellite manufactures, with more than 85 spacecraft operating in geostationary orbit. As of the writing of this paper, 29 of these include 1.5kW Hall Thrusters, accumulating over 70,000 hours of on-orbit operation. The first flight of the higher power 4.5kW Hall Thruster is scheduled for 2018. Now, for the first time in company history, SSL has developed on-site thermal vacuum chambers suitable for electric propulsion testing from initial R&D through qualification and acceptance testing.

## Nomenclature

$I_{SP}$	= specific impulse
$\Delta V$	= velocity change
$I_{SUN}$	= solar intensity
$r$	= radius from the sun
$P$	= pressure
$T$	= temperature
$\rho$	= density
$R$	= gas constant

## I. Introduction

IN recent years SSL has made concentrated efforts across all divisions to diversify the product line; this is especially true within propulsion. Included in these efforts have been increased qualification levels of the heritage SPT-100 thruster, dramatic investments in higher power Hall thrusters, small satellite thrusters, increased pneumatic and power processing capability, and the construction and implementation of on-site vacuum testing.

The first SSL launch of a Hall Thruster subsystem occurred in March 2004. Since that point, SSL has accumulated 70,000 on-orbit operational hours with the SPT-100 subsystem. As of the writing of this paper, 29 spacecraft (116 thrusters) have been launched with electric propulsion. Over 50% of SSL spacecraft in production now carry electric propulsion for station keeping and/or orbit-raising. The use of electric propulsion allows for reduced mass and volume, and as a result can lower the cost of launch for a spacecraft.

The intent of this publication is to update on the success of the SPT-100 subsystem based upon on-orbit lessons learned, preview the 4.5kW class Hall thruster subsystem which will first fly in 2018, and describe some of the current projects underway with the SSL electric propulsion R&D laboratory. A brief overview of the new SSL program to launch hosted payloads and small satellites onboard geostationary communication satellites is given.

---

<sup>1</sup> Engineer, Propulsion Development, [ian.johnson@sslmda.com](mailto:ian.johnson@sslmda.com)

<sup>2</sup> Engineer, Propulsion Development, [ewan.key@sslmda.com](mailto:ewan.key@sslmda.com)

<sup>3</sup> Engineer, Propulsion Development, [ty.lee@sslmda.com](mailto:ty.lee@sslmda.com)

<sup>4</sup> Engineer, Propulsion Development, [ryan.bae@sslmda.com](mailto:ryan.bae@sslmda.com)

<sup>5</sup> Program Manager, Strategic Ventures, [negar.feher@sslmda.com](mailto:negar.feher@sslmda.com)

## II. The SPT-100 Subsystem

The SSL SPT-100 subsystem has been extensively described previously in SSL publications [1,2,3] and as such will only be summarized here. Selected fully qualified heritage components of the subsystem are shown in Fig. 1. Built by the Experimental Design Bureau Fakel [5], the SPT-100 hall-effect thruster has over 25 years of on-orbit flight heritage worldwide. The SPT-100 subsystem implemented on SSL spacecraft is capable of North/South station keeping (NSSK), inclination and eccentricity control, momentum wheel unloads, and spacecraft  $\Delta V$  for orbit raising.

Each SPT-100 delivers a life-averaged 83mN of thrust with a specific impulse of 1570sec while operating at 300V and 4.5A (1.35kW). The placement of the thruster assembly varies by spacecraft, but generally provides less than a 5mN-m impingement torque to the spacecraft at any given time while eroding less than 20 microns from the solar panels over the lifetime. The high specific impulse compared to chemical propulsion (300sec nominal) allows for dramatically less propellant mass on the spacecraft, lowering launch costs and/or increasing lifetime. For example, a daily NSSK requirement of 700N-sec, spread over 15 years (3.8MN-sec) would require 1300kg of propellant with chemical propulsion, a factor of 5 higher than is necessary with the SPT-100 subsystem (260kg).

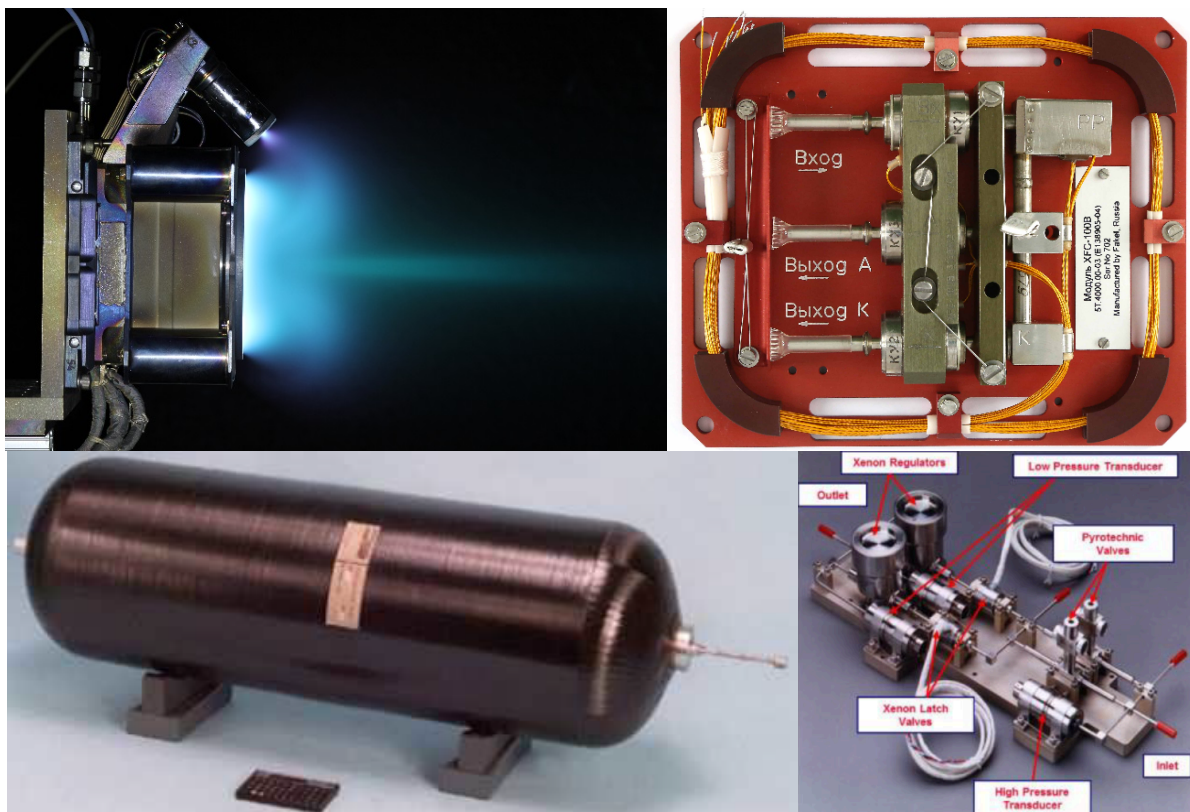

**Figure 1. The SPT-100 thruster operating at 1.35kW, xenon flow controller, propellant management assembly, and COPV tank (clockwise from top left).**

The nominal SSL SPT-100 subsystem has four thrusters for dual redundancy, mounted on two dual-axis positioning mechanisms. Propellant is stored in carbon fiber overwrapped pressure vessels (COPV), regulated down to 37psia through a mechanical regulator, with fine control of the flow rate provided by a 0-25W thermothrottle. Orifices immediately upstream of the thruster split the flow between the anode and cathode to a 13:1 ratio. Analog power processing units provide all necessary electrical inputs to the thruster and flow controller. The subsystem schematic is shown in Fig. 2.

COPV Tanks  
 Pressure Regulation  
 Flow Regulation  
 SPT-100 Thruster  
 Power Processing Unit

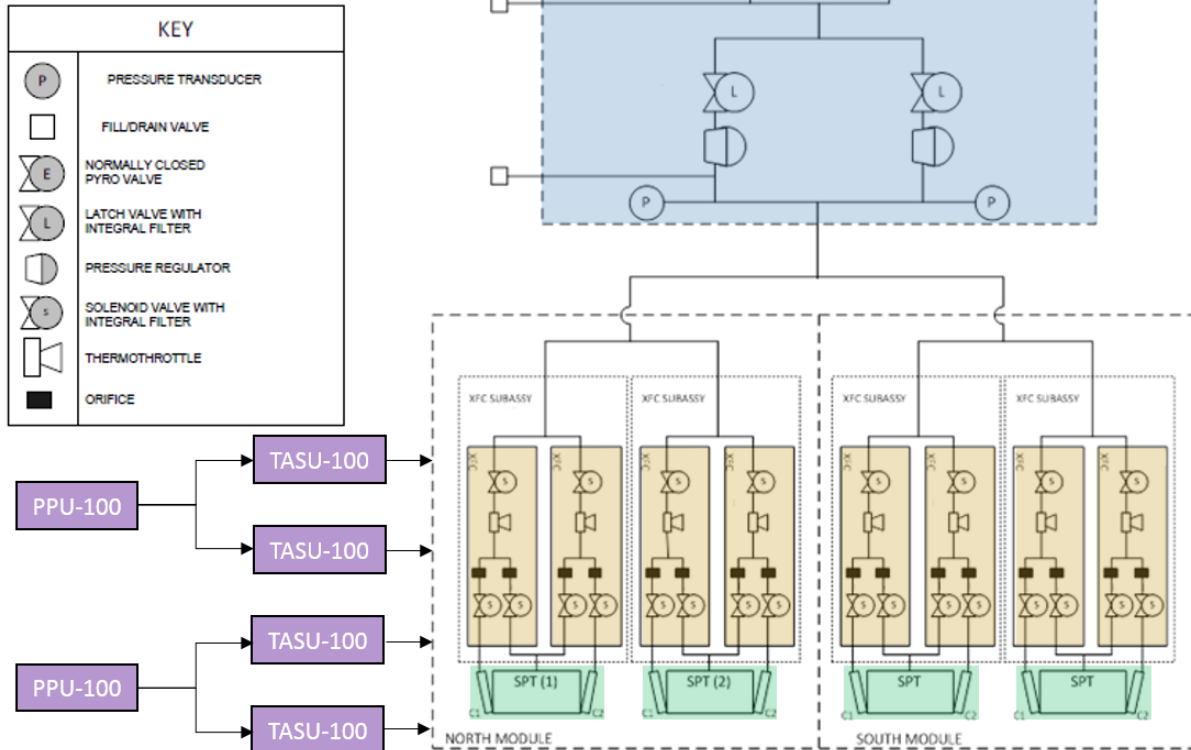
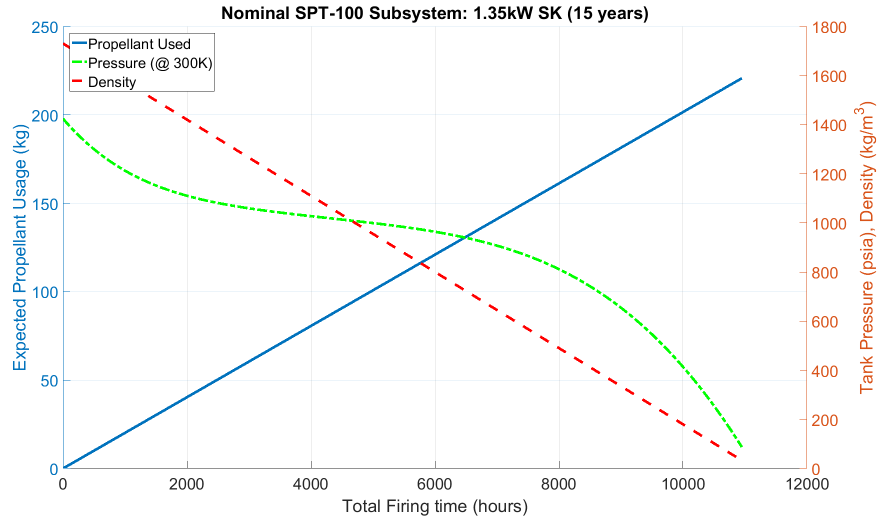

Figure 2. The SPT-100 subsystem block diagram.

The dual-axis positioning assemblies are mounted on the north and south faces of the satellite. Each assembly holds two thrusters for redundancy, two cathodes per thruster, and one flow controller per cathode. The dual axis capability allows for a thrust direction along the +Z axis of the spacecraft for electric orbit raising and electric deorbiting, as well as a thrust direction through the center of mass for on-orbit operations. The standard SSL 1300 bus configuration is designed such that both of these nominal thruster orientations minimize plasma impact on the solar arrays and antennas, in order to minimize erosion, transferred heat flux, and impingement forces.

Assuming two NSSK maneuvers per day, each lasting 60 minutes, would result in a nominal daily NSSK impulse of 250N-sec. Spread over a 15 year mission, this would require 1.4MN-sec lifetime impulse per thruster, well within the capability of an SPT-100. For a nominal flow rate of 5.6mg/sec per thruster; the resultant 15 year station keeping propellant mass of 110kg per thruster.

A detailed subsystem performance analysis is completed before every mission. Predicted results are regularly compared to on-orbit data for all active spacecraft. An example EP-100 analysis is shown in Fig. 3 for a 15 year mission. Assuming the same NSSK requirements detailed above and a starting Xenon mass of 225kg housed within a 130L tank, the following results were computed based on a constant 83mN force and 5.6mg/sec flow rate.



**Figure 3. Nominal mass, pressure, and density profiles for an SPT-100 subsystem spacecraft.**

The tank pressure has a non-linear dependency on the stored propellant mass due to the highly variable pressure vs. density relationship. The non-linearity of the gas constant for Xenon is shown in Fig. 4, calculated from the NIST database.

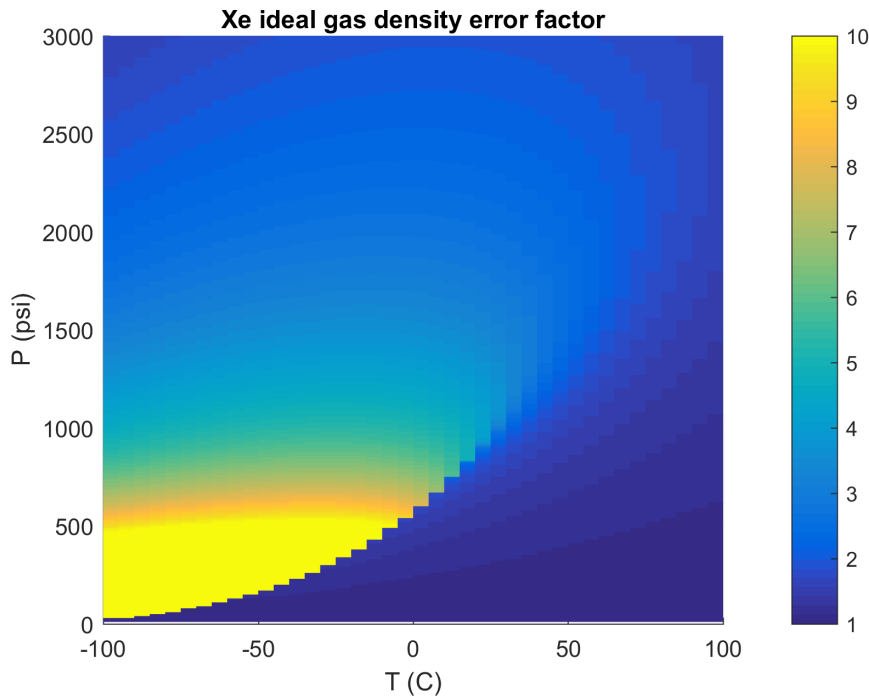
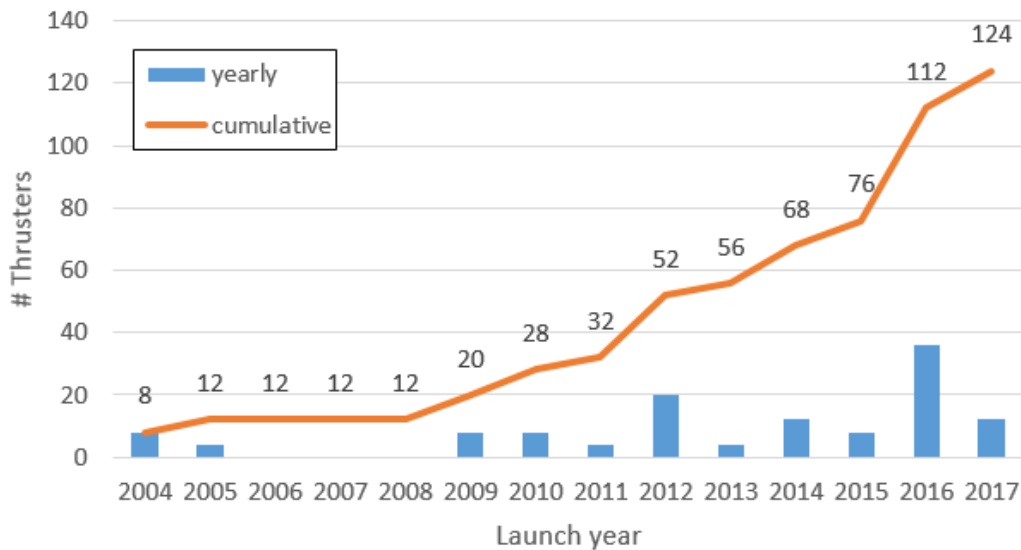

**Figure 4. Xenon ideal gas constant error factor as a function of pressure and temperature.**

The first SSL spacecraft with onboard electric propulsion was launched in 2004. As of the writing of this paper, 29 SSL GEO communication satellites have electric propulsion subsystems (116 total Hall thrusters). An additional two are expected to launch by the end of 2017, bringing our total of Hall thrusters up to 124. 2018 is expected to see the launch of an additional eight SPT-100 Hall thrusters and 12 SPT-140 Hall thrusters.



## SSL Electric Propulsion Summary



**Figure 5. SSL spacecraft with electric propulsion subsystems onboard.**

Of the 29 spacecraft launched to date, 6500kg of Xenon has been loaded, with 1400kg used. SSL has accumulated 70,000+ hours of on-orbit operation spread over 62,000+ unique activations. The SPT-100 nominal flow rate is 5.6mg/sec (20.2g/hr), while on-orbit data shows a mission-averaged rate of 5.9mg/sec (20.5g/hr) calculated from tank pressures and thruster operational time. This average includes losses due to cathode warm-up. This rate of Xenon usage has been constant across the SSL fleet, averaging less than a 3% variance between spacecraft.

The SPT-140 is expected to have a flow rate roughly three times as high. Note that the propellant usage shown in Fig. 6 is per spacecraft and not per thruster. At a minimum the propellant used (and hours of operation) are spread over two thrusters and at maximum spread over four.

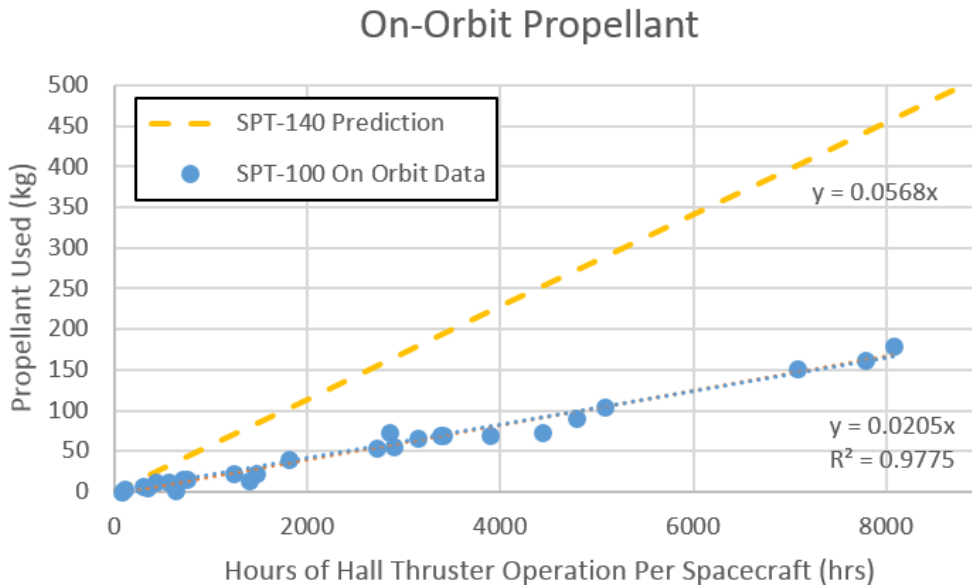

**Figure 6. SSL on-orbit propellant accounting of the SPT-100 subsystem and predicted usage for the SPT-140.**

The 29 SSL spacecraft with electric propulsion launched to date, as well as the three scheduled for later in 2017, are shown in Fig. 7. Note the diversity of the spacecraft sizes, antenna configurations, and solar panel arrangements. The electric propulsion subsystem SSL has designed is robust enough for implementation on all of the spacecraft shown, with only minor modifications from program to program. This robustness allows for dramatic reductions in cost through the economics of scale, eliminating repetitive design validation test sequencing, and amortizing NRE for both hardware and software qualification efforts over multiple programs.

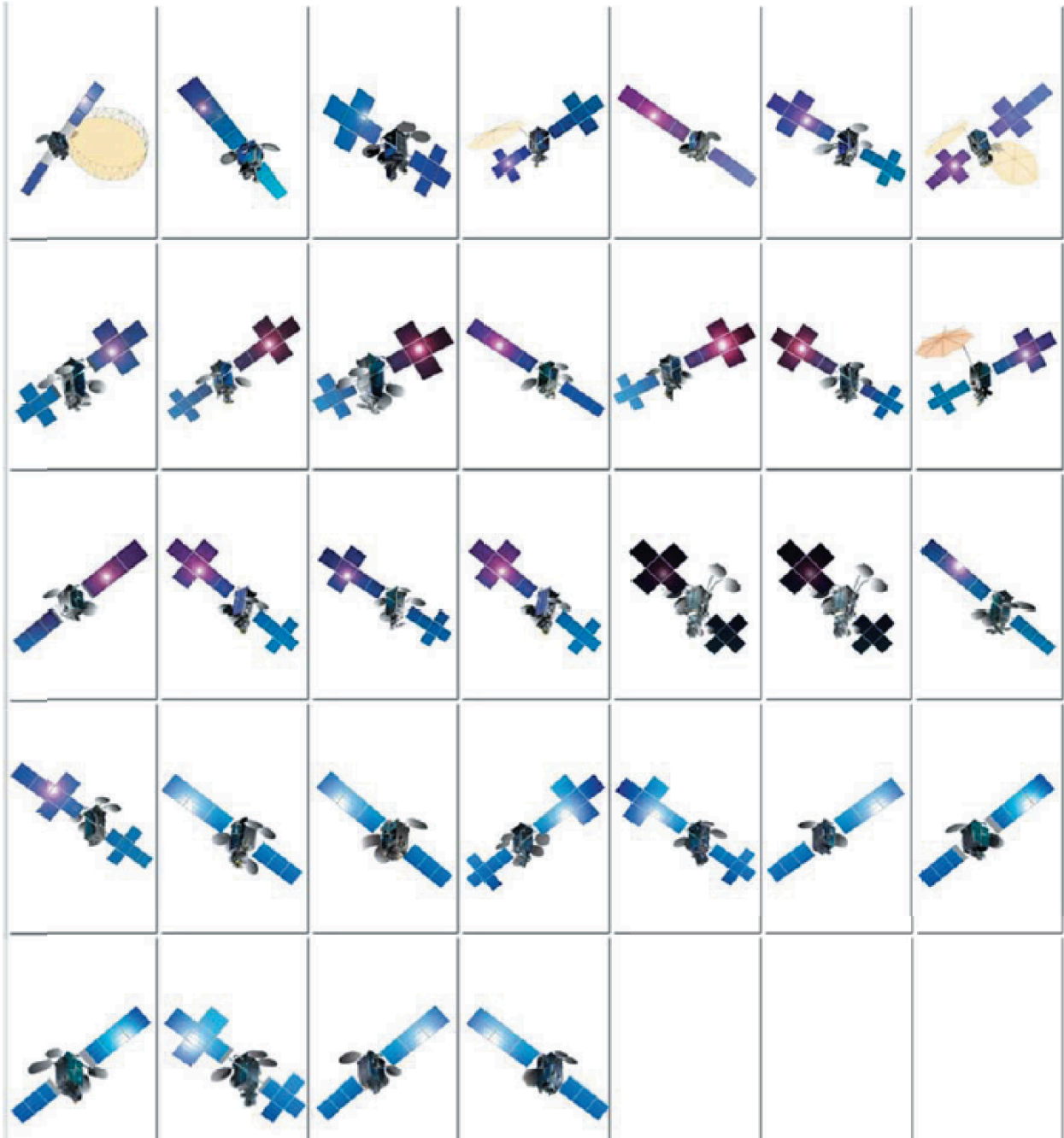
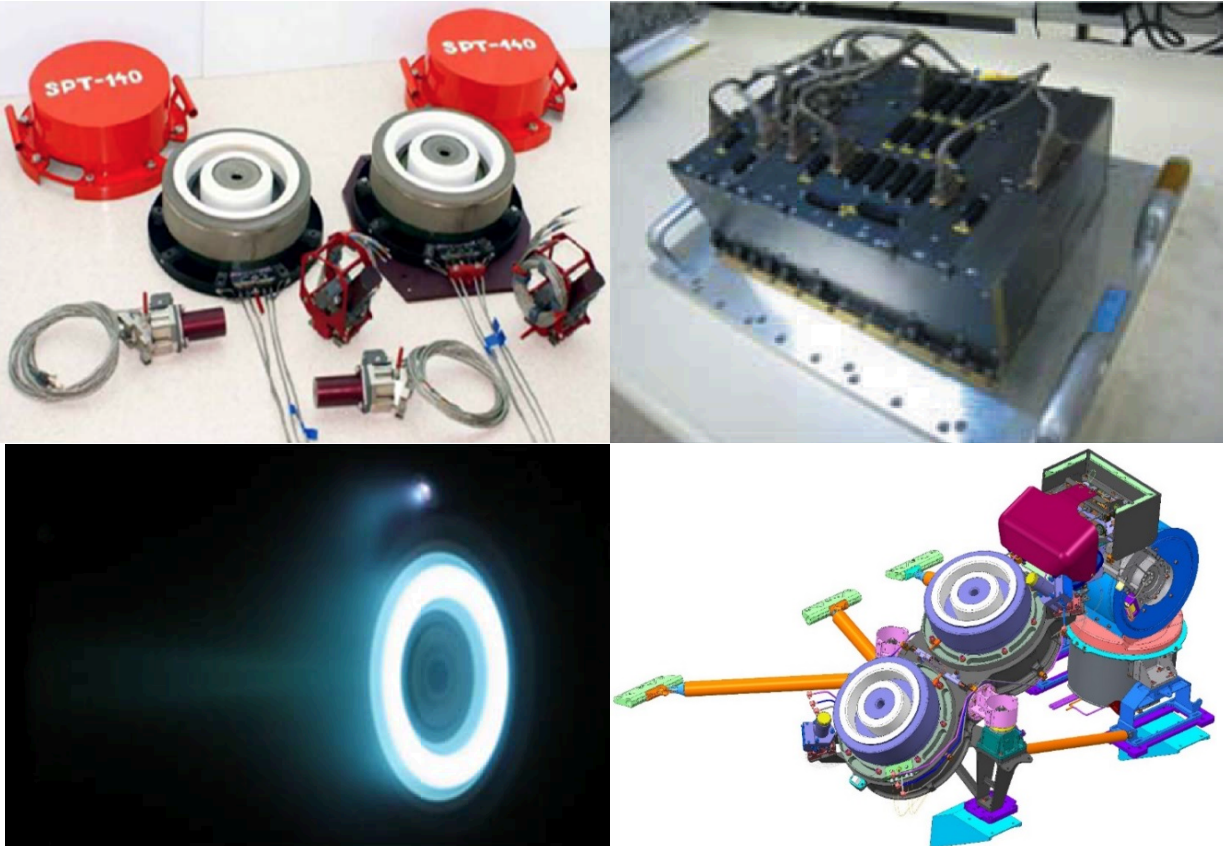

Figure 7. SSL's electric propulsion fleet.

### III. The 4.5kW Electric Propulsion Subsystem

Building upon the highly successful SPT-100 subsystem developed and operated by SSL, a number of higher power thrusters are currently in development. The first to fly will be the SPT-140, currently scheduled for Q2 2018. The SPT-140, similar to the SPT-100, is a Fakel built Hall thruster, is fully qualified, and ready for flight. SSL has developed a fully increased capability subsystem (selected components shown in Fig. 8), including a new dual-axis positioning mechanism, a higher power PPU, and a new operational and flight software scheme.



**Figure 8. The SPT-140 thruster, PPU-140, DSM-140, and SPT-140 in operation at 4.5kW (clockwise from top left).**

The SPT-140 has been qualified for power levels between 3.0 and 4.5kW. Electric orbit-raising is currently planned for high power operation, while station keeping will be at lower power levels. The higher thrust and specific impulse of the SPT-140 (280mN and 1770sec at 4.5kW) compared to the SPT-100 allows for dramatically reduced electric orbit durations, lower spacecraft masses, and longer mission durations. These lower transfer orbit durations now allow for spacecraft to be flown with only electric propulsion onboard. The cost savings due to the reduced mass by eliminating the chemical propulsion components outweigh the revenue lost due to the longer orbit raising with electric propulsion.

Similar to the EP-100 subsystem, the EP-140 subsystem has four thrusters mounted on two dual-axis positioning mechanisms. The high pressure Xenon is regulated down to low pressure through a mechanical regulator, with fine control of the flow rate provided by a thermothrottle. Orifices immediately upstream of the thruster split the flow between the anode and cathode. Analog power processing units provide all necessary electrical inputs to the thruster and flow controller. The standard SPT-140 subsystem schematic is shown in Fig 9.

COPV Tanks  
 Pressure Regulation  
 Flow Regulation  
 SPT-140 Thruster  
 Power Processing Unit

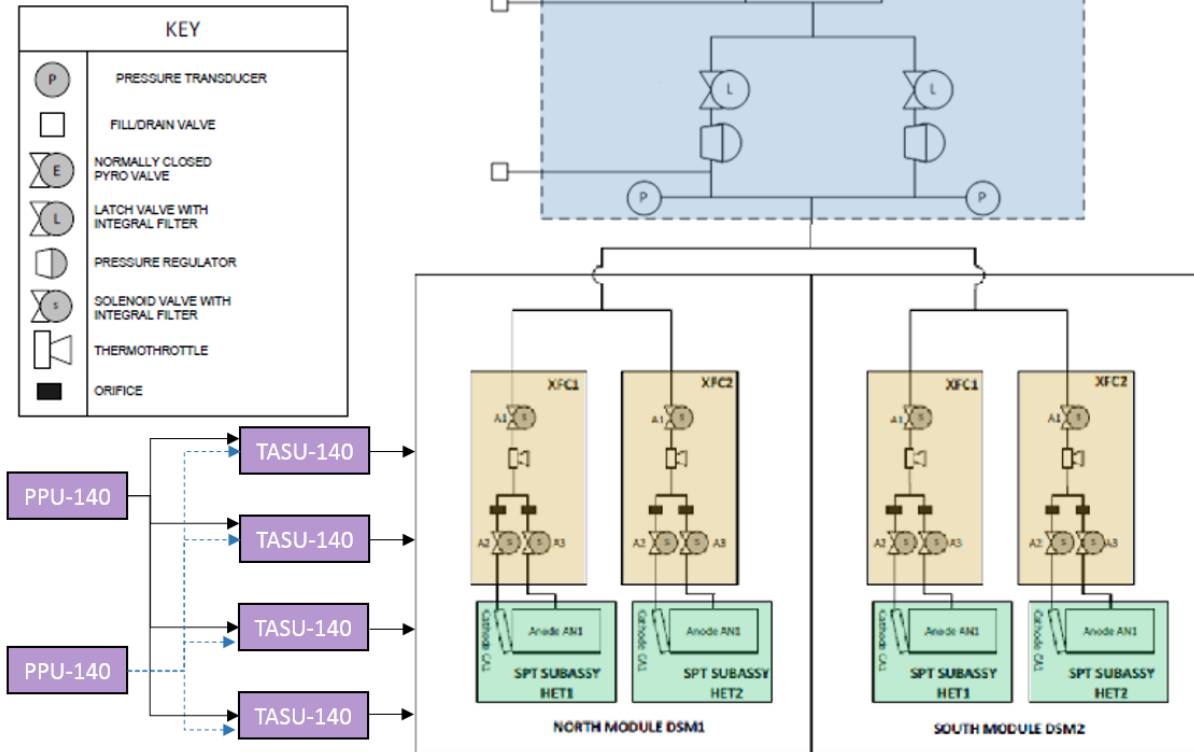
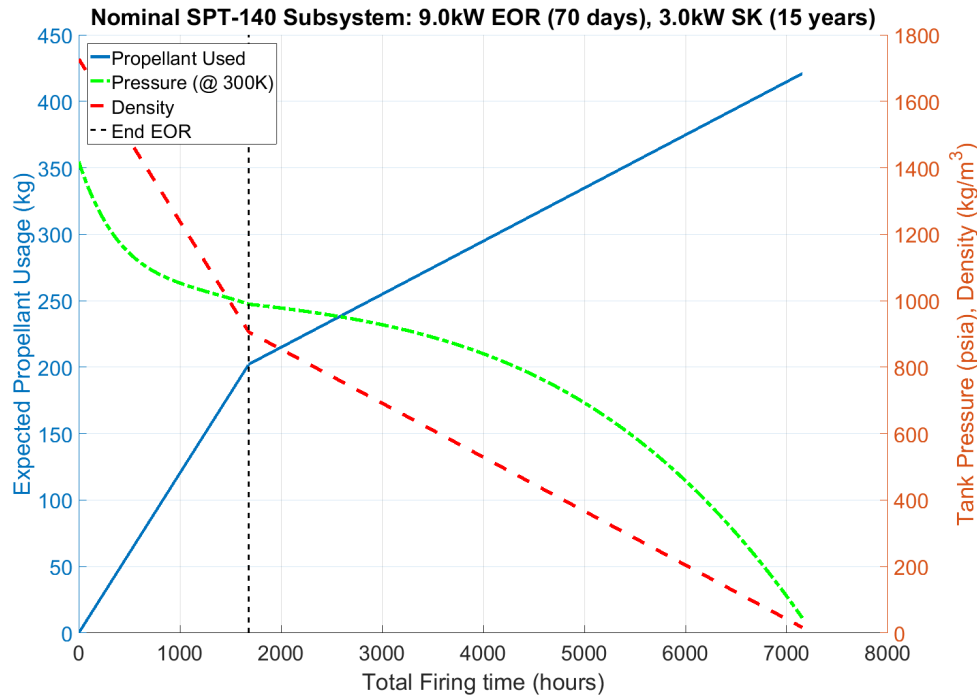

Figure 9. The SPT-140 subsystem block diagram.

The dual-axis positioning mechanisms are mounted on the north and south faces of the satellite. Each mechanism holds two thrusters, one cathode and one flow controller per thruster. The dual axis capability allows for a thrust direction along the +Z axis of the spacecraft for electric orbit raising or electric deorbiting, as well as through the center of mass for on-orbit operations. The spacecraft and thruster assemblies are configured to minimize plume impingement on solar arrays and antennas for both thrust directions.

To increase the power processing unit redundancy, a fully cross-strapped electrical design has been developed. Each PPU has the capability of interfacing with up to four thrusters. The added redundancy at the PPU level, in addition to an increase in familiarity with electric propulsion, has allowed the use of only one cathode per thruster. This cross-strapping capability increases the reliability of the propulsion subsystem, and subsequently the spacecraft.

Similar to the EP-100 system, a detailed performance analysis will be completed for each spacecraft. The SPT-140 thruster is assumed to have a constant 280mN (170mN) thrust and flow rate of 16mg/sec (11mg/sec) at 4.5kW (3.0kW). An example EP-140 analysis is shown in Fig. 10. Assuming 70 days of electric orbiting raising at dual 4.5kW operation, followed by 1 hour of station keeping per day for 15 years while operating at 3.0kW, and a beginning of life Xenon mass of 425kg contained within a 250L tank, the following prediction is created.



**Figure 10. A nominal propellant mass and tank pressure profile for an SPT-140 subsystem spacecraft.**

The EP-140 subsystem is currently being modified for deep space operation onboard the NASA Psyche Spacecraft. This will require dramatic throttling of the power and flow rate which is not currently necessary for operation in GEO. Power available at 3.3AU will be an order of magnitude lower ( $I_{\text{SUN}} \sim r^{-2}$ ), suggesting that the maximum power available to the thruster subsystem will be less than 1kW at Psyche [7].

#### IV. New Development

SSL has heavily invested in R&D to increase propulsion capabilities. This includes internal R&D, internal subsystem integration, and outside vendor component qualification. A few of our ongoing internal R&D efforts specifically designed for new SSL markets, are briefly described below. The hardware and software listed here has been designed to be easily compatible with the wide variety of thrusters SSL is considering for our small satellite, GEO communication, and deep-space proposals. Work is ongoing to build up capability for 4.5kW class Hall Thruster R&D efforts. Additional information on the testing services SSL provides can be found at

- [https://www.sslmda.com/html/subsystems\\_services.php](https://www.sslmda.com/html/subsystems_services.php)

#### Test Infrastructure

SSL has 50+ vacuum chambers on campus. The chambers are housed in varying degrees of clean-rooms, the highest degree of control is class 10,000. Thermal control is maintained through LN2 platens, shrouds, and cold plates. From a propulsion standpoint, they can be roughly divided into three categories, all shown in Fig. 11.

- TVAC belljars for material research
- TVAC chambers for CubeSAT-class thrusters and cathode testing
- TVAC chambers for 1.5kW class Hall Thrusters

The small TVAC belljars can reach base pressures of mid  $10^{-7}$ Torr and temperatures of -180C to +200C. Two test apparatus' are shown below. The first is to determine the thermal conductivity of grafoil gaskets between a heated titanium plate (DSM simulator) and a platen controlled stainless steel plate (thruster simulator).

A 6ft diameter x 10ft length chamber has been setup for 200W thruster testing. The chamber is capable of pulling a base pressure of mid  $10^{-7}$ Torr without a thruster, and high  $10^{-5}$ Torr with a flow rate of 2mg/sec of Xenon.



The cathode shown firing below was used to test the effectiveness of bang-bang and proportional flow control valve regulation of the Xenon.

SSL's 10ft diameter x 20ft length thermal chamber setup for 1.5kW hall thruster testing is capable of pulling a base pressure of mid  $10^{-7}$ Torr and high  $10^{-5}$ Torr with a flow rate of 6mg/sec of Xenon. The chamber is capable of achieving -170 to +180C temperature control through a platen and shroud. The large volume of the chamber allows for limiting the wall effects from the system, creating a more space-like environment for the thrusters to operate in.



**Figure 11. Belljars for thermal gasket testing (top), the 6x10 chamber for cathode testing (right), and the 10x20 chamber for 1.5kW thruster operation (center, lower).**

SSL has vibration tables sized for component level R&D, small satellite development, and GEO spacecraft acceptance testing. The tables are designed for a variety of purposes, including displacement, velocity, acceleration, and force. These accurately simulate the vibration levels seen on launch vehicles, as well as simulate the vibration environment associated with on-orbit thruster firing, solar array deployment, and antenna release. Two such tables are shown in Fig. 12.



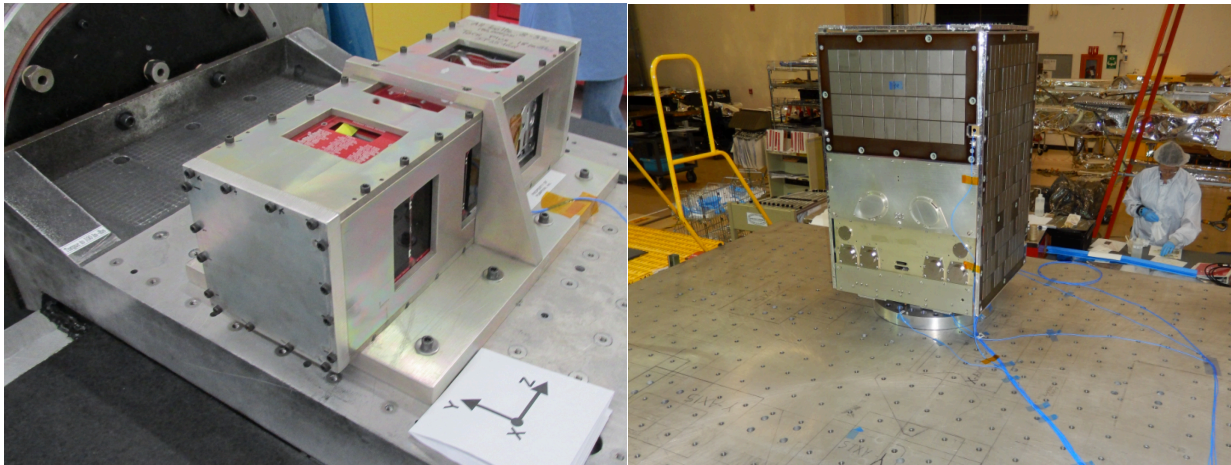

Figure 12. SSL vibration table testing for the Stanford University QB50 project (left) and a SkySat development unit (right).

Table 1. Summary of SSL test chambers and vibration tables.

Thermal Vacuum Chambers				
Clean Room Classification	Chamber Size (dia. x len.)	Base Vacuum	Thermal Range	Platen Area
	in x in	Torr	°C	in x in
M6.5 (100K PPM)	23 x 47	>5 x 10 <sup>-7</sup>	140 to -65	16 x 25
M6.5 (100K PPM)	104 x 210	>5 x 10 <sup>-7</sup>	180 to -100	48 x 48
M5 (10K PPM)	72 x 70	>5 x 10 <sup>-7</sup>	180 to -100	48 x 48
M6.5 (100K PPM)	114 x 137	>5 x 10 <sup>-7</sup>	160 to -160	48 x 48
Vibration Tables				
Clean Room Classification	Table Area	# Channels	Force Rating (Sine/Random)	Displacement (pk-pk)
	in x in		lbf	in
ECA (Environmentally Controlled Area)	20 x 20	32	10000/10000	1
ECA	28 x 28	16	8000/8000	2
M6.5 (100K PPM)	42 x 42	64	17000/16000	1
ECA	48 x 48	32	17000/16000	1

### Thrust Stand

An inverted pendulum thrust stand has been built for the testing of 200W – 5kW (10mN – 500mN) class thrusters as shown in Fig. 13 integrated with an SPT-100 thruster. The load cell and hinge strength can be modified depending on the thrust level of the mounted thruster. Accuracy and sensitivity down to 1mN has been measured.

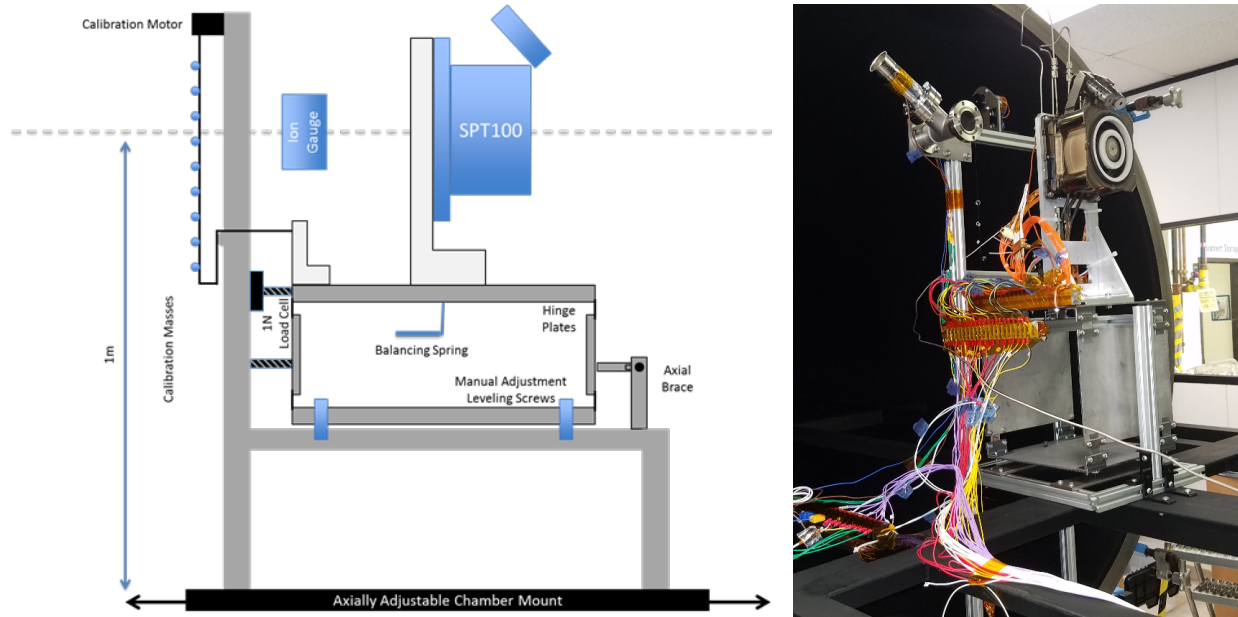

**Figure 13. The SSL inverted pendulum thrust stand.**

### Bang-Bang Pressure Regulator

Numerous previous thruster experiments and flights have used a bang-bang pressure regulator [8, 9] due to its inherently high reliability and ability for a wide range of operational pressures. The system is based around the opening and closing of upstream valves to maintain the pressure within a downstream plenum to within a small range. Changing the allowable pressure range, for example to switch from high power to low power thruster operation, is as simple as uploading a command. The system can operate multiple thrusters under variable pressures using the same qualified hardware, dramatically reducing the non-recurring engineering typically associated with pressure changes.

SSL is setup to test a number of parameters within a bang-bang regulator and can easily implement such a design with any experimental thruster. The baseline SSL setup, shown in Fig. 14, allows for variable inlet pressure, a variable intermediate volume between the operational valves, a variable plenum volume, heater power into the plenums, and a variable outlet flow rate. Measurements are made of the upstream and downstream pressure, temperatures, and flow rates.

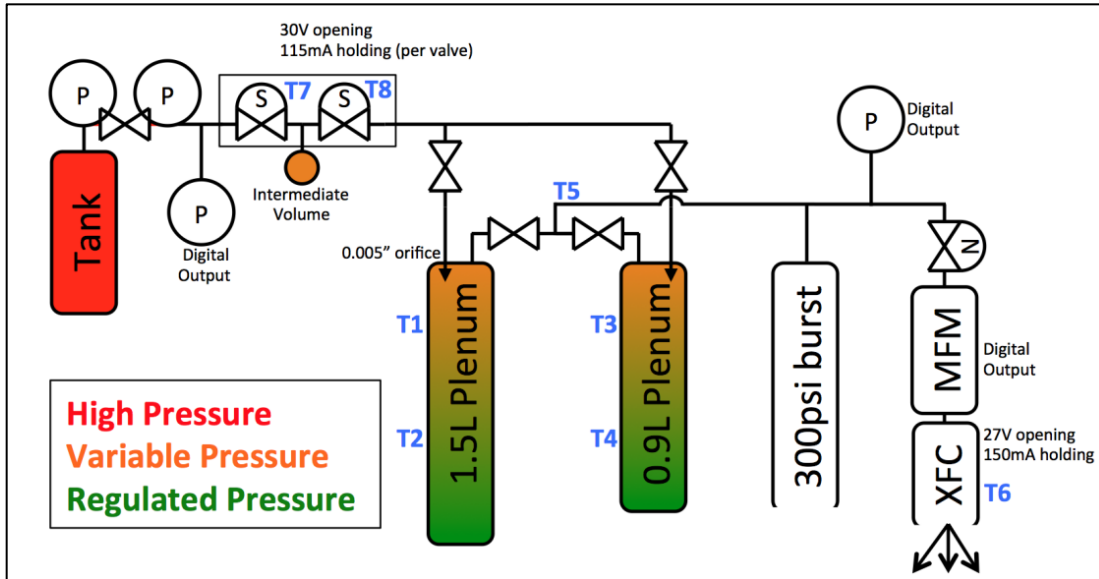

Figure 14. The baseline bang-bang pressure regulator schematic.

An SPT-100 was tested with an experimental bang-bang regulation system using Xenon propellant. The system has been run at multiple inlet pressures and plenum volumes. The SPT-100 thrusters electrical characteristics and plume showed no variation due to the constantly varying pressure (35-38psia) and flow rate (5.3-5.6mg/s) associated with the bang-bang regulator system. The data shown in Fig. 15 was taken with an inlet pressure of 200psia, 0.9L plenum, and thruster at 300W, while operating at a chamber pressure of  $3 \times 10^{-4}$  Torr.

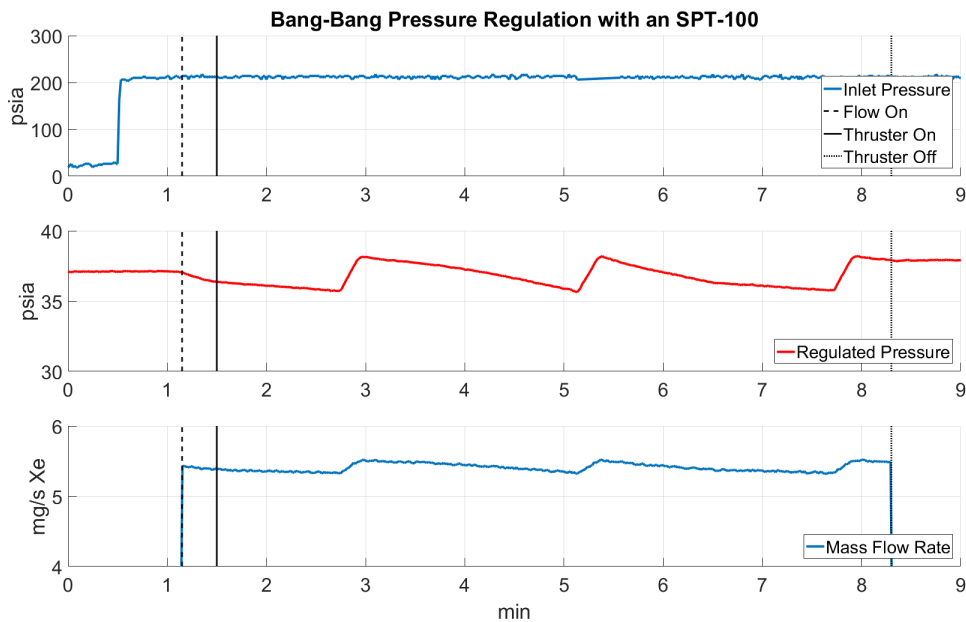

Figure 15. SSL bang-bang regulator system input pressure, regulated pressure, and flow rate while operating with an SPT-100 thruster.

#### Proportional Flow Control Valve for Flow Regulation

The use of a proportional flow control valve (PFCV) for pneumatic control of electric propulsion thrusters has been extensively studied [10, 11]. Using a valve capable of pressure and flow rate changes based on physically moving a valve poppet allows for a wide operational range. The Moog PFCV currently in testing with the SSL

subsystem can throttle Xenon from pressures of 2700psia down to the operational pressures required for electric propulsion. Control of valve is based on current flowing through the coils. To regulate the flow rate at levels necessary for Hall Thrusters will require current control at a precision of 10's of microamps.

A PFCV has been implemented with an engineering model of the SPT-100 thruster for flow rate control at SSL, as shown in Fig. 16. Using a simple Arduino based PID control circuit allows for regulating the Xenon based on the downstream pressure, flow rate, or thruster discharge current.

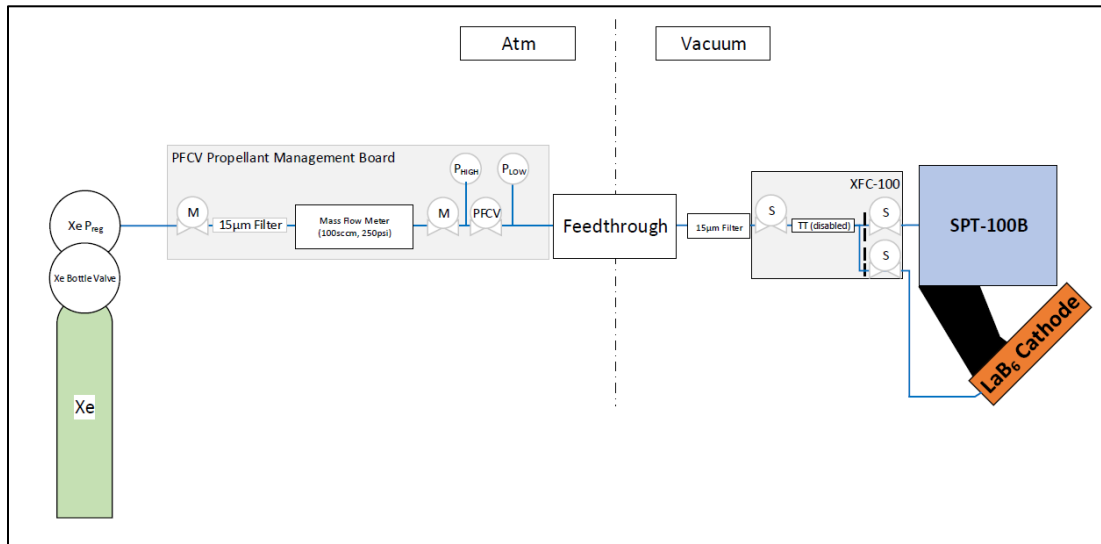

Figure 16. The PFCV / SPT-100 test setup.

The SPT-100 thruster can be operated from the PFCV at a wide range of input pressures using Xenon propellant. Shown in Fig. 17, the inlet pressure was slowly decreased from 275psia down to 125psia with no variation to the thruster's electrical characteristics or plume measured. The PFCV current was increased from 110 to 111mA while maintaining the regulated outlet flow rate necessary for thruster operation.

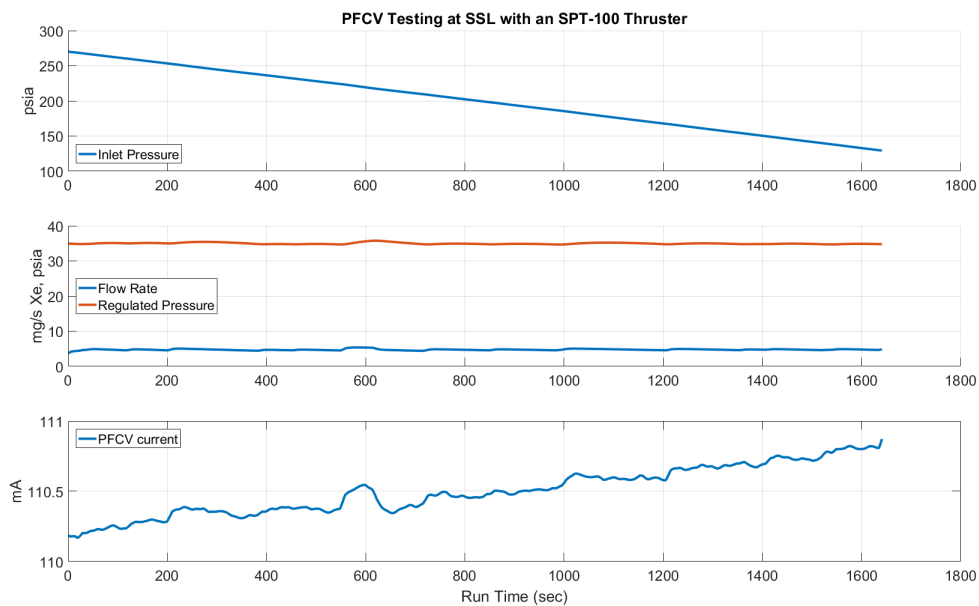

Figure 17. Input pressure, regulated pressure, output flow rate, and the valve current from the PFCV controlled system operating with the SPT-100 thruster.

## V. Payload Orbital Delivery System

A new service by SSL, the Payload Orbital Deliver System (PODS)<sup>12</sup>, has been designed and implemented to allow low-cost access to space for small satellites. PODS is patent pending, application #14/716,795. The first PODS system, shown in Fig. 18, is planned for launch in 2017. This system is capable of delivering small satellites with or without propulsion subsystems into orbit at low cost. SSL now has the capability to fully test and fly electric propulsion subsystems designed for these 10's of kilogram mass satellites.

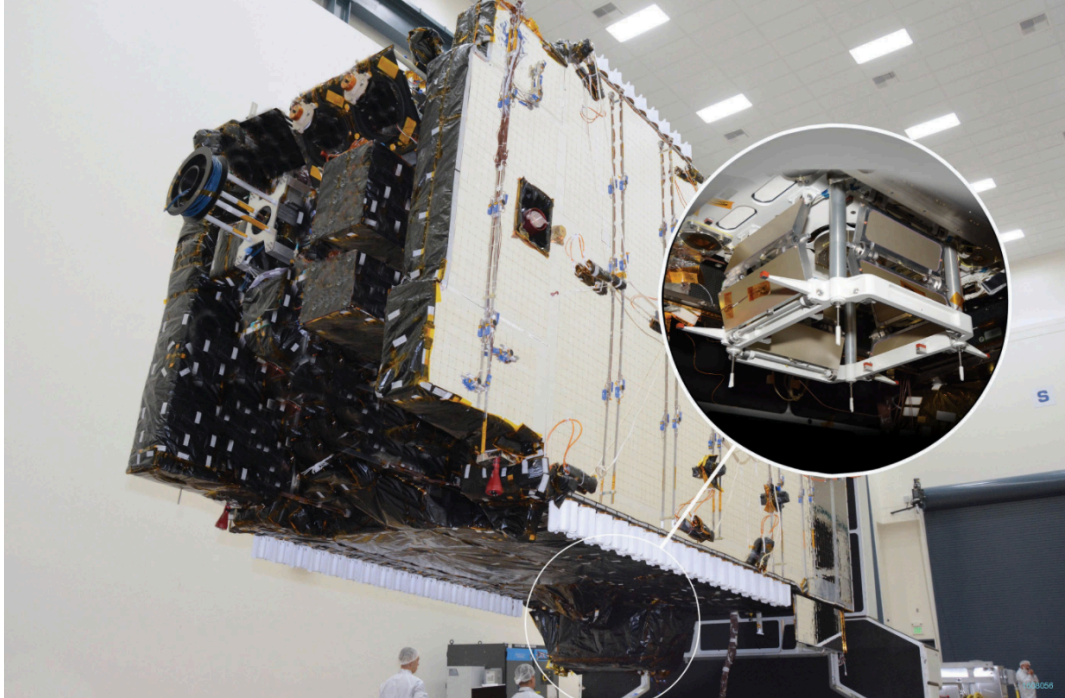

Figure 18. A PODS dispenser mounted to an SSL spacecraft (patent pending, #14/716,795).

SSL launches an average of six GEO spacecraft per year. Most have the capability for rideshare options for small satellites or hosted payloads that are permanently integrated onto the host spacecraft. The PODS system is a standardized interface that allows the SSL spacecraft to launch a small satellite into a Geosynchronous Transfer Orbit (GTO) or a Geosynchronous Earth Orbit (GEO). Unlike other small satellite launch services, the use of the PODS platform with SSL spacecraft allows for the use of gaseous propulsion subsystems.

Table 2. Nominal timeline for PODS missions.

Event	Timeline
Contract	Launch - 24 months
Mass Model Delivery	Launch - 9 months
Product Delivery	Launch - 3 months
Integration to Host	Launch - 2 months
Ship to Launch Base	Launch - 1 month
Deployment to Orbit	GTO: Launch + 1 day GEO: Launch + (2 weeks*, 1-6 months**)

\* Chemical Propulsion Orbit Raising

\*\* Electric Propulsion Orbit Raising

There are tangible benefits from using commercial hosts and standardized interfaces. Most significantly, a standard form factor enables rapid call-up and low NRE. A commercial host reduces risk of schedule delay that can



be common with scientific or military launches. SSL does not require detailed knowledge of the spacecraft payload, only enough information to ensure safety. As such, priority information can be kept confidential. By using this proven technology, access to space for small satellites is cheaper, easier, and based around a highly reliable system.

A nominal PODS spacecraft will have a wet mass up to 75kg, volume up to 1x0.5x0.4m, and design life up to 5 years. SSL can accommodate both chemical and electric propulsion, as well as provide any analysis or test service required for the small satellite. A previous PODS spacecraft can be seen in Fig. 19 mounted near the SPT-100 Hall Thruster assembly. Additional information on the PODS program can be found at:

- <https://www.sslmda.com/pods/index.html>

## VI. Conclusion

SSL has been flying electric propulsion onboard geostationary communication satellites for 15 years. The first EP enabled spacecraft is expected to deorbit within the decade. More than 70,000 hours of on-orbit operation have been accumulated by SSL. Through all of this, the original design has only mandated small changes. Part of this can certainly be attributed to customers' reluctance to see a successful design undergo modification. However, credit must certainly be given to the original engineers and technicians who developed and built this highly successful subsystem design. It has truly withstood the test of time.

As SSL transfers into "Space 2.0", change will come faster. Some of those changes have been mentioned here. Further improvements will be rolled out in coming years as SSL continues to diversify its product line.

## Acknowledgments

The authors thank the entire team here at SSL and at our vendors around the world. The ongoing success of SSL spacecraft, and the propulsion subsystem specifically, is directly reflected by your tireless work ethic.

## References

<sup>1</sup>Delgado, et. al., "Space Systems Loral Electric Propulsion Subsystem: 10 years of on-orbit propulsion". IEPC-2015-04, International Electric Propulsion Conference, 2015.

<sup>2</sup>Delgado, J., et. al. "Qualification of the SPT-140 for use on Western Spacecraft". AIAA-2014-3606, AIAA Joint Propulsion Conference, 2014.

<sup>3</sup>Corey, R. and Pidgeon, D., "Electric Propulsion at Space Systems Loral". IEPC-2009-270, International Electric Propulsion Conference, 2009.

<sup>4</sup>Goebel, D. and Katz, I., "Fundamentals of Electric Propulsion: Ion and Hall Thrusters". Wiley and Sons, 2008.

<sup>5</sup>Morozov, A. and Savelyev, V. "Fundamentals of Stationary Plasma Thruster Theory". Reviews of Plasma Physics, 2000.

<sup>6</sup>Corey, R., et. al. "Hall Thruster Plume Model for Spacecraft Impingement Torque: Development and Validation" Journal of Spacecraft and Rockets, 2008.

<sup>7</sup>Silva, T., et. al. "Adaptability of the SSL SPT-140 Subsystem for use on a NASA Discovery Class Mission: Psyche", International Electric Propulsion Conference, 2017.

<sup>8</sup>Ganapathi, G.B., et.al., "Post-launch performance characterization of the Xenon Feed System on Deep Space One", AIAA-99-2273, AIAA Joint Propulsion Conference, 1999.

<sup>9</sup>Brophy, M., et. al. "The Ion Propulsion System For Dawn", AIAA Joint Propulsion Conference, 2003.

<sup>10</sup>Polzin, K., and Pepples, S. "Iodine thruster Propellant Feed System for a CubeSAT", AIAA Propulsion and Energy Forum, 2014.

<sup>11</sup>Bushway, E., et. al. "A Xenon flowrate controller for Hall Current Thruster Applications", International Electric Propulsion Conference, 2001.

<sup>12</sup>Gunn, L., et. al. "DARPA Phoenix Payload Orbital Delivery System: Progress towards Small Satellite Access to GEO", AIAA Small Satellite Conference, 2015.