



# NASA Docking System (NDS) Technical Integration Meeting

*November 17, 2010*

*Skip Hatfield  
NDS Project Manager*





- ◆ 8:00 – 9:00 Registration
- ◆ 9:00 – 9:15 Welcome
- ◆ 9:15 – 9:45 NASA Docking Strategy
- ◆ 9:45 – 11:15 Docking Overview
- ◆ 11:15 – 12:00 Hardware Overview w/break
- ◆ 12:00 – 1:00 Hardware Demonstration/Viewing
- ◆ 1:00 – 1:30 Lunch
- ◆ 1:30 – 2:30 Software Overview
- ◆ 2:30 – 2:45 NDS Major System Interfaces, Integration Information
- ◆ 2:45 – 3:00 Break
- ◆ 3:00– 3:30 Schedule, Future Upgrades
- ◆ 3:30– 3:30 Questions & Answers
- ◆ 3:30 – 4:30 Repeat Demo and hardware viewing



- ◆ Purpose today: provide an open forum to discuss the **NASA Docking System (NDS)**
  - Briefings
  - Demonstrations
  - Hardware exhibits
  - Opportunities to interact on technical aspects of the NDS
  
- ◆ Open discussion is encouraged
  - Provide current status of the NDS and interfaces to host vehicles
  - Provide feedback from the potential user community
  
- ◆ Will collect most pertinent discussions and make available in the public domain



- ◆ NASA has made a policy decision to collaborate with its International Partners to develop an International Docking System Standard (IDSS) to enable
  - Greater international cooperation in space
  - International crew rescue capability
  
- ◆ NDS is NASA's implementation of a docking system compatible with the recently released International Docking System Standard (IDSS)
  - Background on IDSS can be found at <http://www.internationaldockingstandard.com/>
  - The IDSS standardizes both soft capture and hard capture interfaces
  - The NDS is being designed to be in compliance with the standard
  
- ◆ NASA has chosen to demonstrate the new IDSS on the International Space Station (ISS) by replacing the current Pressurized Mating Adapters with an IDSS-compatible system using a Common Docking Adapter (CDA)

## ISS Common Docking Adapter (CDA) – ISS Location

For ISS missions, the Visiting Vehicle (VV) will carry an active NDS, and will dock to the CDA.

Current planned locations:

- Node 2 Forward
- Node 2 Zenith

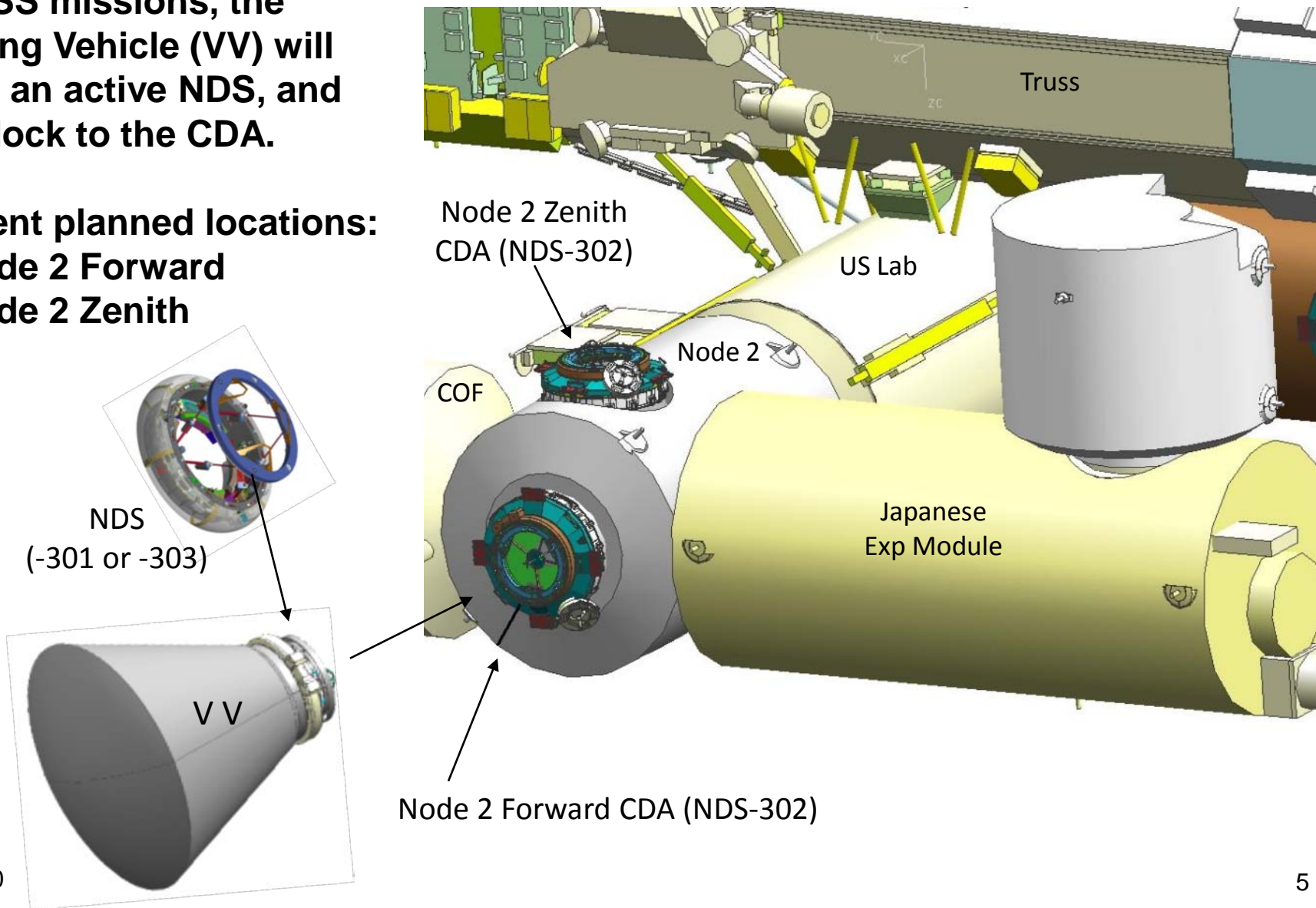



- ◆ Build on proven technologies previously demonstrated in flight
  - Beginning with the systems demonstrated on the Apollo-Soyuz Test Project in 1975
  
- ◆ Advance the state of the art of docking systems by incorporating Low Impact Docking System (LIDS) technology into the NDS
  - The purpose of low impact docking technology is to greatly reduce or eliminate the use of impacts to achieve alignment and capture



- ◆ This is a technical interchange meeting only
- ◆ Export-controlled topics, such as how things work internally cannot be discussed in this forum (they are subject to normal export control procedures)
- ◆ Questions or discussions related to specific procurements cannot be entertained
  - Especially true for the CCDev2 Procurement, which is in blackout
- ◆ Participants should be encouraged to ask questions whose answers might benefit everyone during the full group sessions
- ◆ One-on-one conversations are encouraged, however there should be no expectation of confidentiality.
  - It is our intent to make all information available uniformly to all interested parties



# Docking Overview

*James Lewis*  
*NDS Manager*







## Next Step in Docking Mechanism Evolution

Over the last decade it has been concluded by many organizations and programs (X-38, SLI, OSP, ESR&T, CEV, HST), Gov't and contractor, and including some IP, that the docking mechanism available today and their usage and operation, while acceptable in LEO, are not compatible with future exploration reliability, fault tolerance, affordability, and sustainability goals. Existing docking systems:

- require substantial force and velocity for docking alignment and capture
  - create critical operations
  - affect structure fatigue life
  - disturb zero-g environments
  - difficult for small mass vehicles to use
  - support a limited range of vehicle performance capabilities
- large mechanism which decreases usable spacecraft volume
- low fault tolerance and unreliable sensing which do not support AR&D
- offer unique passive and active interfaces
- do not support berthing/RMS assembly operations
- sustainable/maintainable only on the ground
- production supplier and development data not readily available

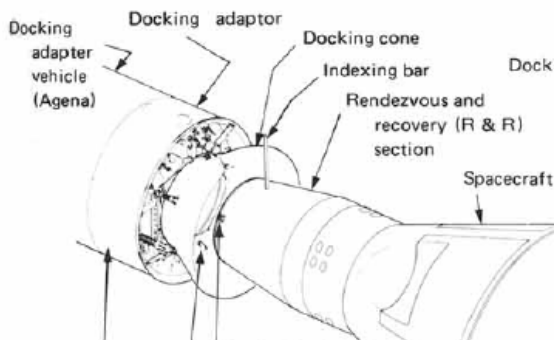

Agena/Gemini

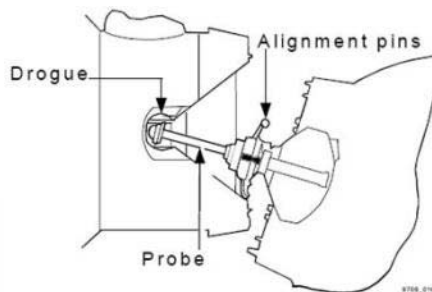

Russian Probe Cone

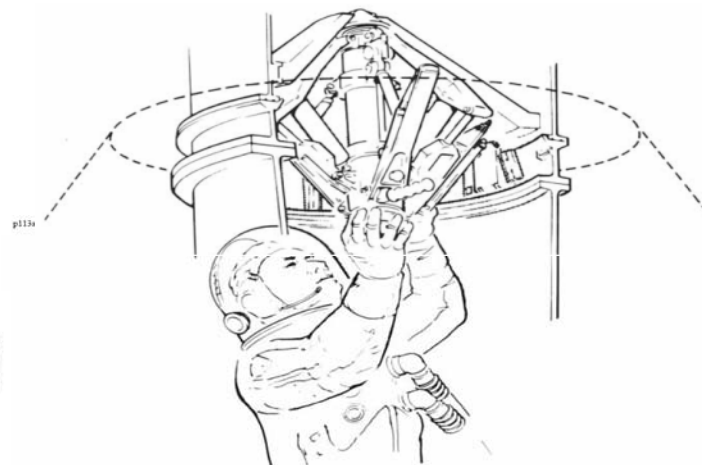

Apollo Probe Cone

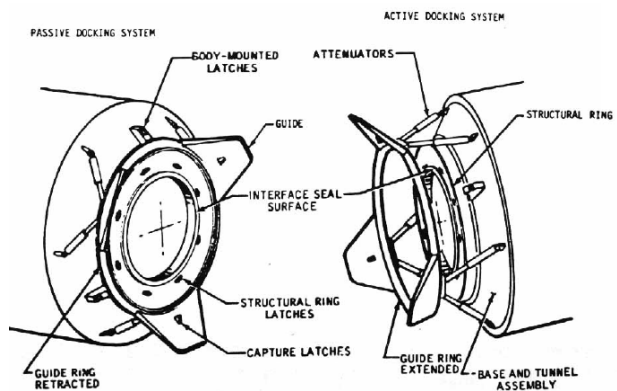

Apollo Soyuz

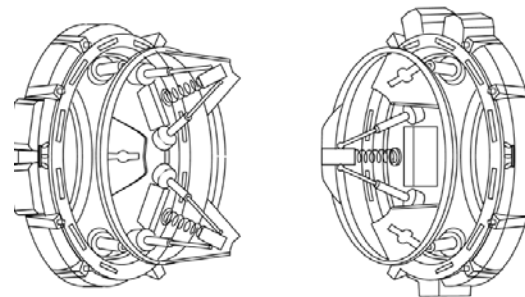

APAS

(No scale is implied between figures)

- ◆ All previous docking mechanisms have required the use of impacts (i.e. velocity or post-contact thrusting) to create the energy required for soft capture mechanism interface alignment and capture between mating docking interfaces
- ◆ Low Impact technology can be used to greatly reduce and even eliminate the need for impact energy and provide the flexibility for future mission planners



LIDS efforts have specifically worked to incorporate lessons learned from previous and current mating system development and flight experiences.

- Next generation DM can be a common interface and implemented as a “standard” (I/F & ops) to:
  - unburden future vehicle/mission developers
  - offer economies of scale in procurement/fabrication/commonality of subsystems
  - simplifications in certification, training, planning, and operations
- Androgynous I/F built from modular assembly able to dock to copies or variants of itself
  - offering ‘system level’ redundancy when fully implemented
  - nominally passive, “ready-to-be-docked-to”; designate active half prior to dock
  - target and chaser role reversal; enable crew rescue (e.g. CEV to CEV)
  - compatible, reduced functionality variants to save weight and/or cost as needed
- Utilize modern technology with S/W driven characteristics “tunable” to meet performance of a broader range of unique operations for mission flexibility
  - offer capture with minimal contact forces, I.e. “low impact”
  - eliminate need for high energy/velocity, time-critical operations
  - offer requirements relief to other vehicle systems and critical vehicle operations
  - providing both docking and berthing capability
  - Real-time performance adjustment and configurability



# NDS/iLIDS - Background



## Low Impact Docking System Technology Development History

- ◆ 1996-2000 X-38 proof of concept soft-capture system /control electronics built and test verified
  - Dynamic testing of soft capture system
  - Closed-loop force feedback soft-capture design validated
  - Verified interface forces for docking & berthing
- ◆ 2001-2002 CRV
  - Began designing 54" OD development unit
  - stopped in '02 @ ~60% complete
- ◆ 2003-2005 SLI/OSP/ESMD/ESR&T
  - Req't's development and trades studies
  - OSP Prime's Contractor Support & Program support
  - In-house Tech Maturation Project to reach TRL6
  - ESAS put LIDS on CEV
- ◆ 2006-2009 Cx/CEV
  - Project transferred into CEV Project
  - ISS LIDS adapter delivery issue forced Cx to re-baseline w/ APAS for ISS and LIDS for Lunar by 2018
  - Trades Jan-May 06, Oct Cx re-baseline LIDS for CEV/ISS by 2012
  - SRR in April/May 07; baseline PTRS released in Aug
  - Orion OVEIWG weight redux from July-Oct → LIDS-Lite
  - PDR Mar 2008; end of 2009 flight design ~90% complete
  - \*\*Passive LIDS i/f dev 06-07 and installed on HST (see photos →)
- ◆ 2010 ISS
  - Feb 1 LIDS Transferred to ISS → iLIDS
  - Req't's and Design shift → "Black box" and to be IDSS compliant
  - Aug re-baseline of requirement documentation
  - Sept baseline draft of IDSS IDD MCB approved

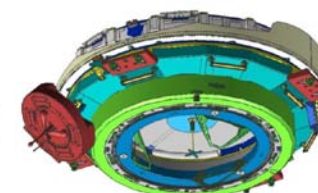
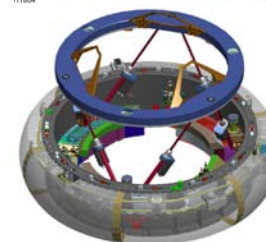
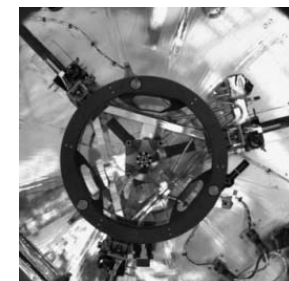
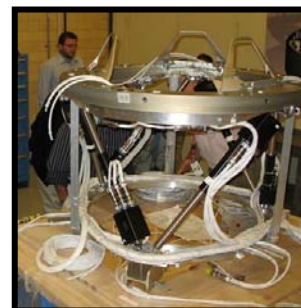



- ◆ The NDS is an androgynous, peripheral docking system
  - Incorporates the low impact technology with the APAS style hook-latch geometry and dimensions per IDSS IDD
  - Facilitates low approach velocity docking via a reconfigurable, active, closed-loop, and force-feedback controlled mating system
  - Supports mating and assembly operations for both crewed and autonomous vehicles
  - Configuration driven by the needs of crewed docking vehicles; I.e. Pressurized crew transfer
- ◆ Four NDS configurations are available (-301, -302, -303, & -304)
  - Later charts will define configuration differences
  - -301 active mechanism under development head for Qualification
  - -302 reduced height variant need for Common Docking Adapter
  - Others are potential variants to meet differing requirements (i.e. 28Vdc)



- ◆ Key docking mechanism requirements summary
  - *Perform soft-capture* between two spacecraft
    - Vehicle movement/thrusting and/or a compliant mechanism is needed to overcome gross interface misalignments to achieve initial capture
  - *Energy absorption/dampening* of residual motion/dynamics
  - *Precision retraction and fine alignment* onto sealing/shear interface (I/F)
  - *Structural mating* of latching mechanism
    - Provide seal compression, interface preload
    - React coupled dynamic loads (ISS reboost, TLI Burns)
  - *Internal pressurization and passage for crew and cargo transfer*
  - *Utilities transfer*
    - Power, data, and commands
    - Consumables: air, water (future), fuel (future)
  - Impart *separation* force/velocity



- ◆ NDS Functional Capabilities (Block 0)
  - Transfer Crew/cargo through 32" (813 mm) diameter with petals removed
    - 27" (685 mm) diameter with petals installed
  - Power and Data pass-through from ISS to Host Vehicle
    - Mechanized umbilicals engage connectors during docking sequence
  - Supports 2 Fault Tolerance (FT) through redundancy (meets ISS requirements)
    - Fault tolerance controls are shared with the host vehicle
  - Autonomous Internal Heater Control
  - Mechanized push off separation system
  - MMOD Protection (except for -302)
    - -302 MMOD protection is provided by the host
  - IDSS compatible, accommodates APAS-like hard mate
  - Sensors indicating soft capture, ready-to-hook, hook position, and undocking complete
  - FDIR (Fault Detection Isolation and Recovery)
    - NDS controllers detect fault and notify vehicle
    - Vehicle performs switching function between systems

## ◆ Typical Lifecycle Profile for Low Earth Orbit Missions

- Key assumptions

- Designed to handle jettison during ascent – Host Vehicle must provide severance and launch abort systems
- Host Vehicle responsible for all GN&C & relative navigation sensors
- Supports 210 day docked mission, 21 day free-flying mission
  - -302 designed for 15 year mission
- If host provides environmental protection during re-entry and landing, system could be refurbished and re-used multiple times; host vehicles may also choose to jettison the NDS prior to re-entry

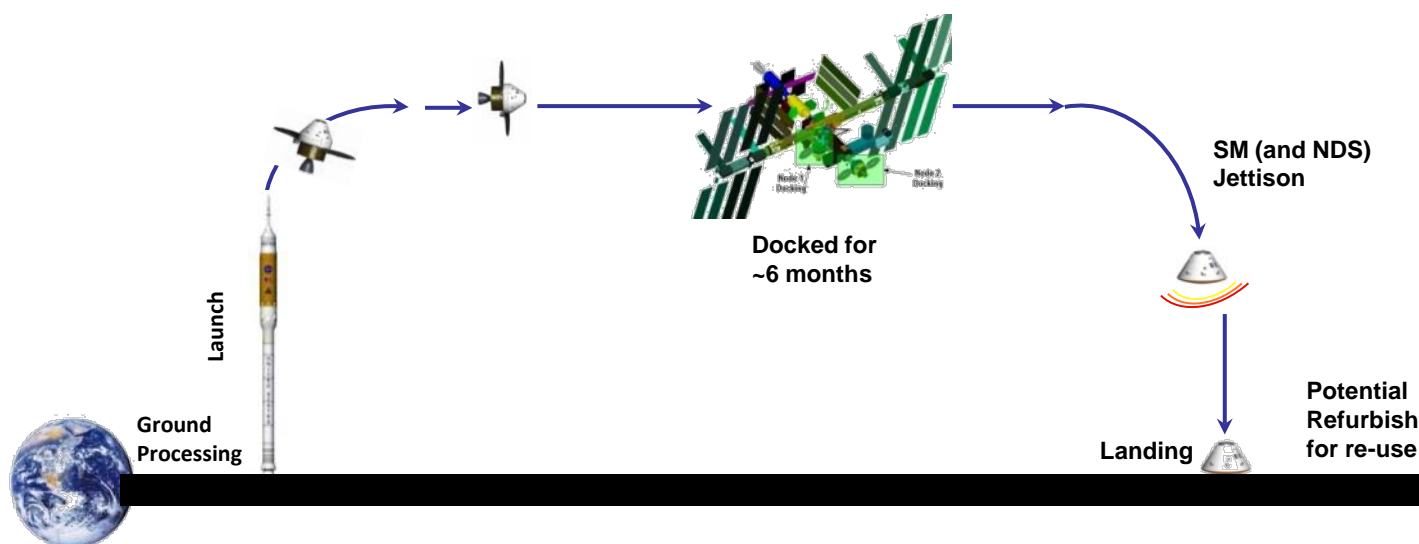





# NDS Hardware Overview

*Chris Lupo*  
*NDS Deputy Manager*



## Docking Sequence



## Hand-Push Demo



- ◆ NDS is being developed as a “black box” for integration with a variety of host vehicles
- ◆ Four “Block 0” configurations are available
  - 301: Core: 120VDC power, integrated electronics (Fully Androgynous)
    - Androgynous configurations can dock in active or passive mode to all configurations or to an IDSS compatible system
  - 302: Short: Reduced height; electronics boxes remotely mounted
  - 303: Low Voltage: Same as 301 except 28VDC power input
  - 304: Abated: Same as 301 except reduced functionality/reduced mass, selected missions

Ready to Dock (Active Mode)  
Soft Capture System Extended



Ready to Dock/Launch  
(Excluding -302 Passive Mode)  
Soft Capture System Retracted

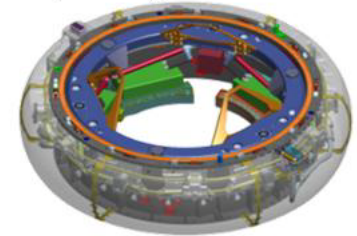

Ready to Dock/Launch  
(-302 Passive Mode)  
Electrical Boxes mounted in host

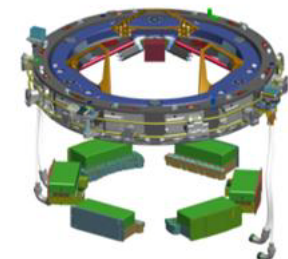

## Ready to Dock - Active Mode (All Configurations Except as Noted)

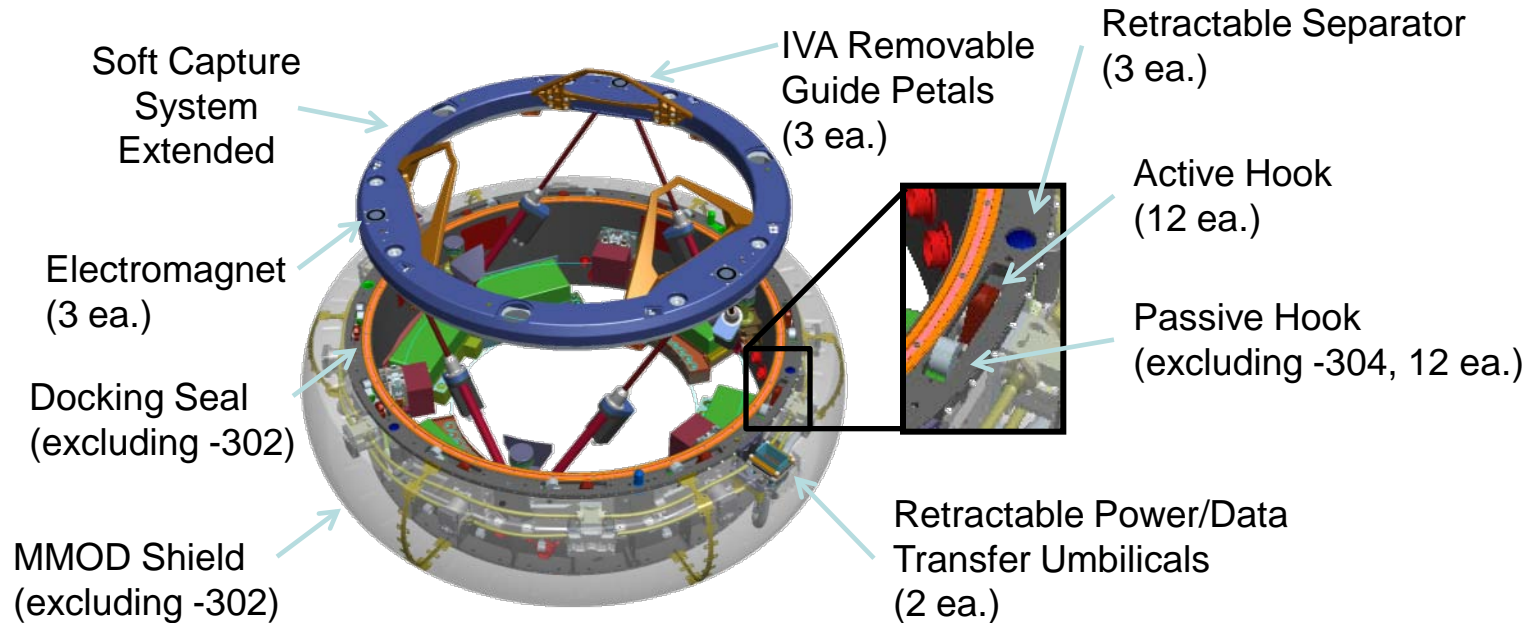

- ◆ The NDS active mode uses the Soft Capture System (SCS) and Hard Capture System (HCS) to complete docking
  - The SCS is an extensible six degree of freedom force feedback platform which actively reacts to align, capture, attenuate loads, and retract
  - The HCS structurally mates the two vehicles & seals for pressurization
    - The HCS nominally engages 12 hooks from one side of the interface, but 12 additional hooks can be engaged from mated system for redundancy or additional structural capacity

## Passive Mode excluding -302

MMOD removed for clarity

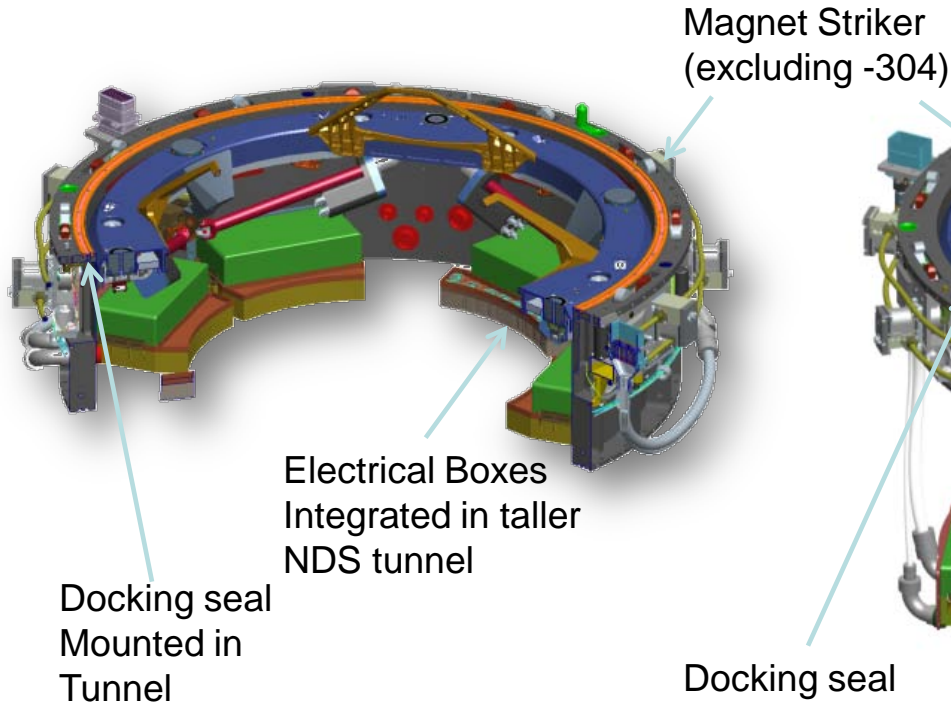

## -302 Passive Mode

MMOD provided by host

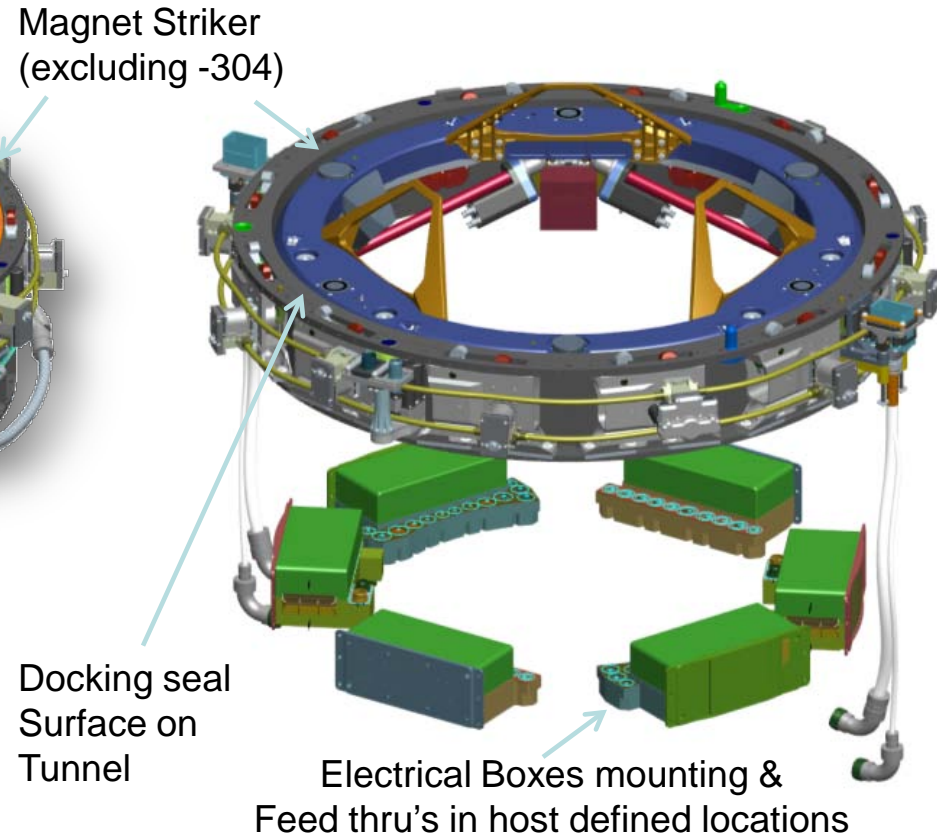

◆ **Passive mode – SCS structurally latched**

- Mode supports launch and docking to another docking system in active mode
- HSC hooks may be used as backup or for increased load capability

## SCS Components

Magnet  
3X @ 120°

IVA Removable  
Guide Petals

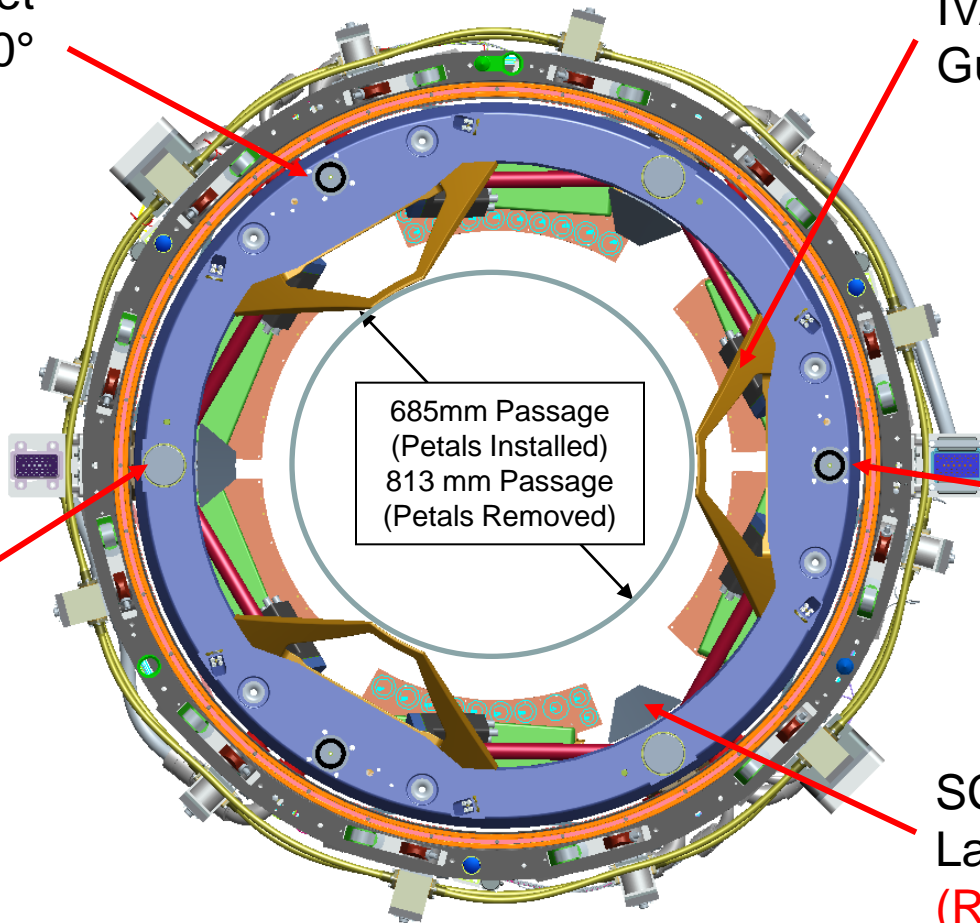

SCS Lockdown  
Located under  
Magnet  
3X @ 120°

Magnet Striker  
3X @ 120°  
(excluding -304)

SCS Mechanical  
Latch Striker  
(Reserved volume  
for future implementation)  
3X @ 120°



- ◆ Soft capture sequence
  - Guide petals make contact
    - Transfer contact/load inputs into the load sensing cells
  - Drive the electromechanical actuators to correct lateral and angular misalignment to trip soft capture sensors
  - Energize magnets to complete soft capture
    - Electromagnetic attachment of the magnets to the passive striker plates on the opposing capture ring
  - SCS attenuates the relative motion between the two vehicles
  - SCS then aligns the two mating vehicles
  - SCS retracts into hard capture range
    - Ready To Hook Sensors trip at 4mm HCS mating plane separation



## NDS Coordinate System

### NDS initial contact conditions (“design to” limits)

Initial Conditions	Limiting Value <sup>1,2,3,4</sup>
Closing (axial) rate	0.05 to 0.15 ft/s (0.015 to 0.045 m/s)
Lateral (radial) rate	0.15 ft/sec <sup>(4)</sup> (0.045 m/s)
Angular rate	0.15 deg/sec about NDS X axis, Vector sum of 0.15 deg/sec about NDS Y and Z axis
Lateral (radial) misalignment	4.2 inches ± .125 inches (106 ± 3 mm)
Angular misalignment	4.0 ± .25 degrees about NDS X axis; vector sum of 4.0 ± .25 degrees about NDS Y and Z axes

1. Initial conditions to be applied simultaneously
2. The NDS will use a right-hand orthogonal body coordinate system. Origin is the intersection of the NDS cylindrical centerline X-axis and HCS mating plane.
3. These initial conditions are applicable for the docking of a chaser host vehicle with a mass of at least 1000 slugs (15000 kg), but no greater than 1700 slugs (25000 kg), to a target vehicle with a mass of at least 24000 slugs (350000 kg).
4. Lateral (radial) rate limit is combined lateral/rotational of both vehicles.

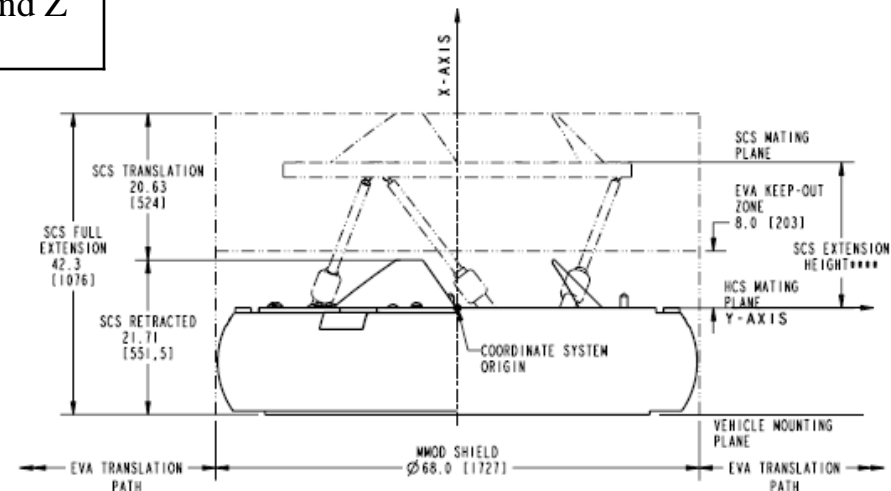
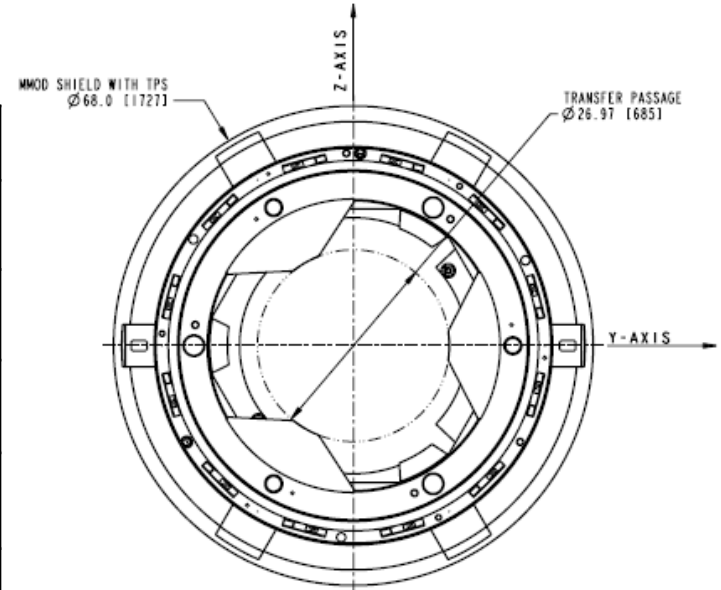



## SCS Maximum Docking Loads

Tension	877 lbf	(3900 N)
Compression (Static)	787 lbf	(3500 N)
Compression (Dynamic, < 0.1 sec)	1461 lbf	(6500 N)
Shear	719 lbf	(3200 N)
Torsion	1106 lbf*ft	(1500 Nm)
Bending	2065 lbf*ft	(2800 Nm)

## SCS Maximum Component Loads

Mechanical Latch Striker Tension	674 lbf		(3000 N)	
Magnetic Latch Striker Tension	517 lbf		(2300 N)	
Striker Compression	674 lbf		(3000 N)	
Petal Edge Length	0%	10%	60%	80%
Petal Contact Loads	787 lbf	517 lbf	517 lbf	225 lbf
	(3500 N)	(2300 N)	(2300 N)	(1000 N)

## HCS Hook and Drive-train

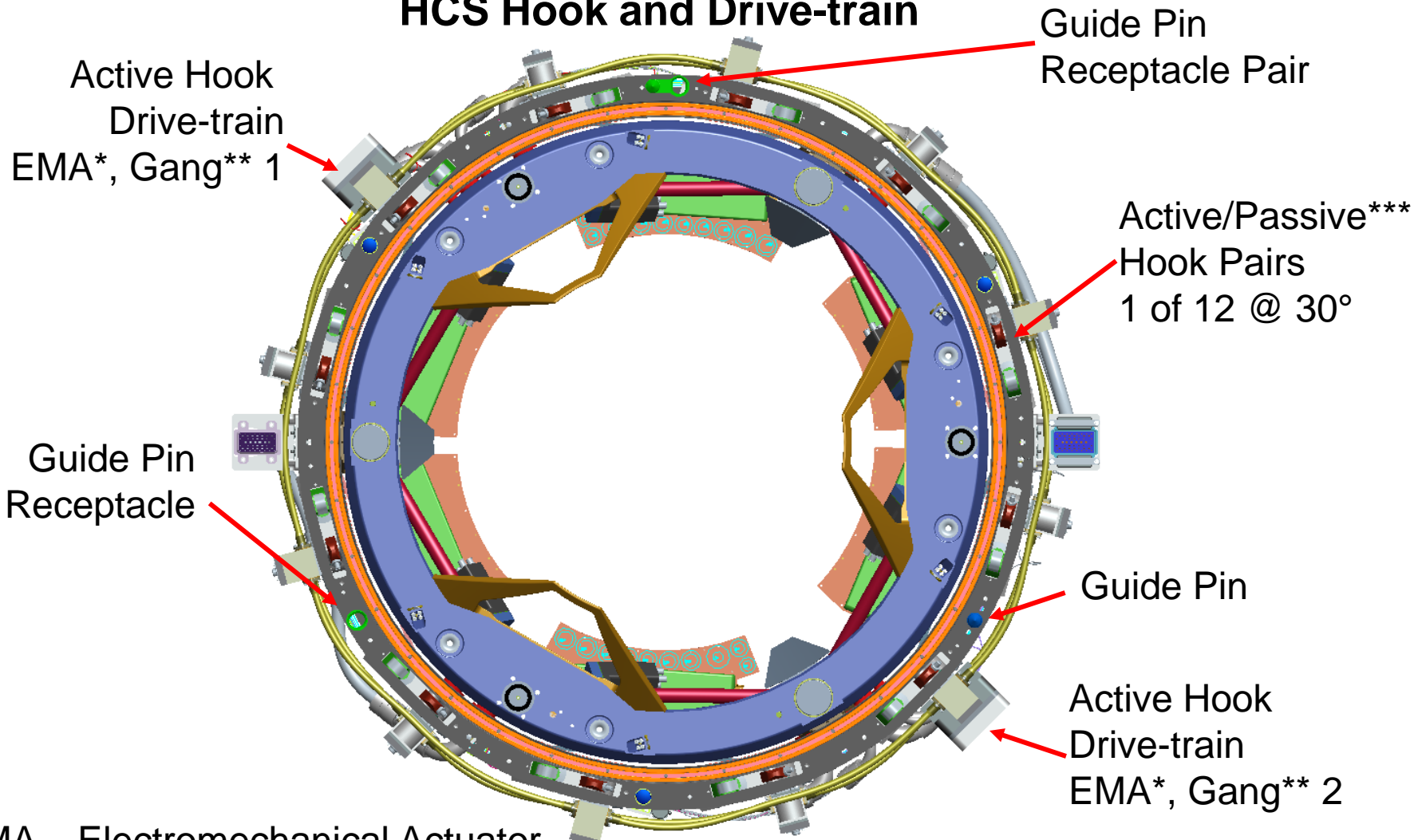

\*EMA – Electromechanical Actuator  
\*\*6 hooks per gang (Every other hook)  
\*\*\*Passive hook not included in -304

- ◆ The IDSS Active / Passive hook pairs evolved from the Apollo Soyuz Test Program structural interface
- ◆ The hook interface was further refined for Mir, Shuttle, and International Space Station (ISS) dockings using the Androgynous Peripheral Assembly System (APAS)
- ◆ IDSS compatible docking system hooks can achieve structural mate with APAS hard capture systems

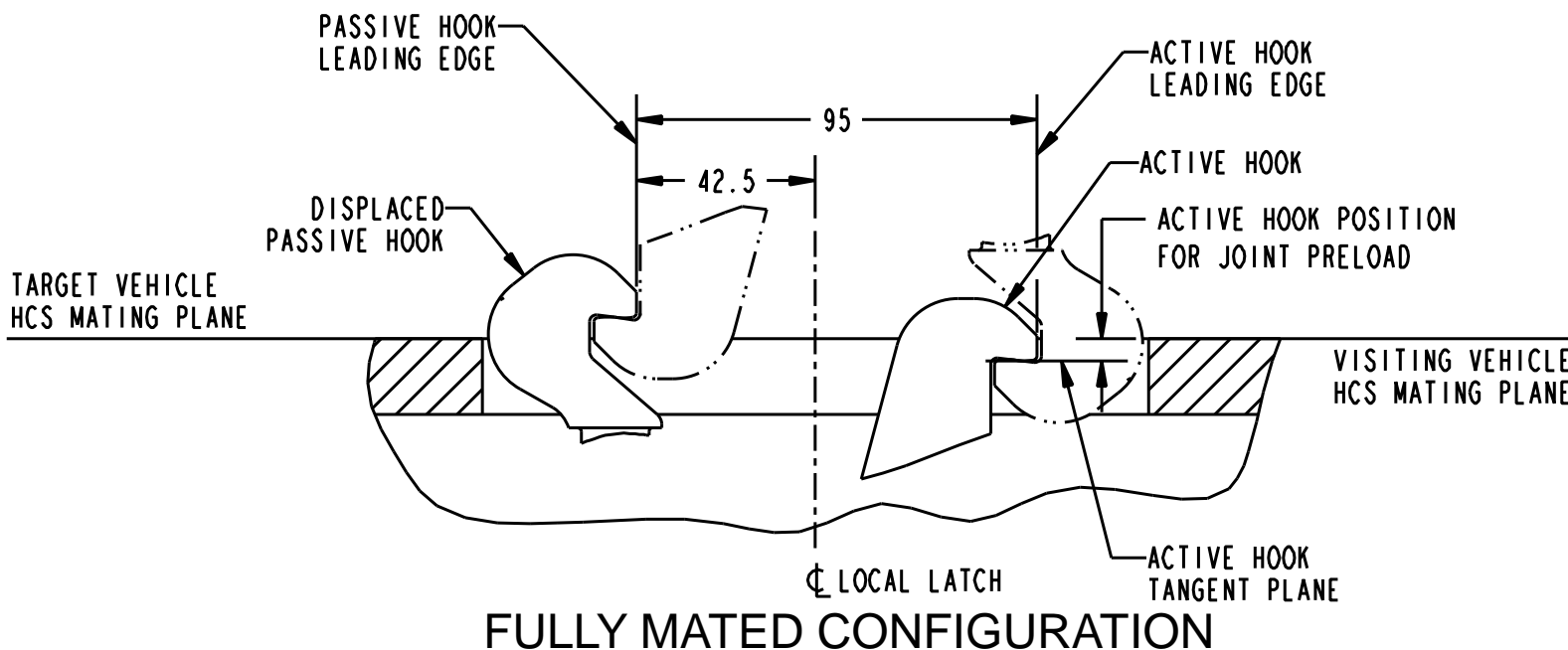

## HCS Sensors\*, Umbilicals, Separation System

Ready to Hook Sensor  
(1 of 3)

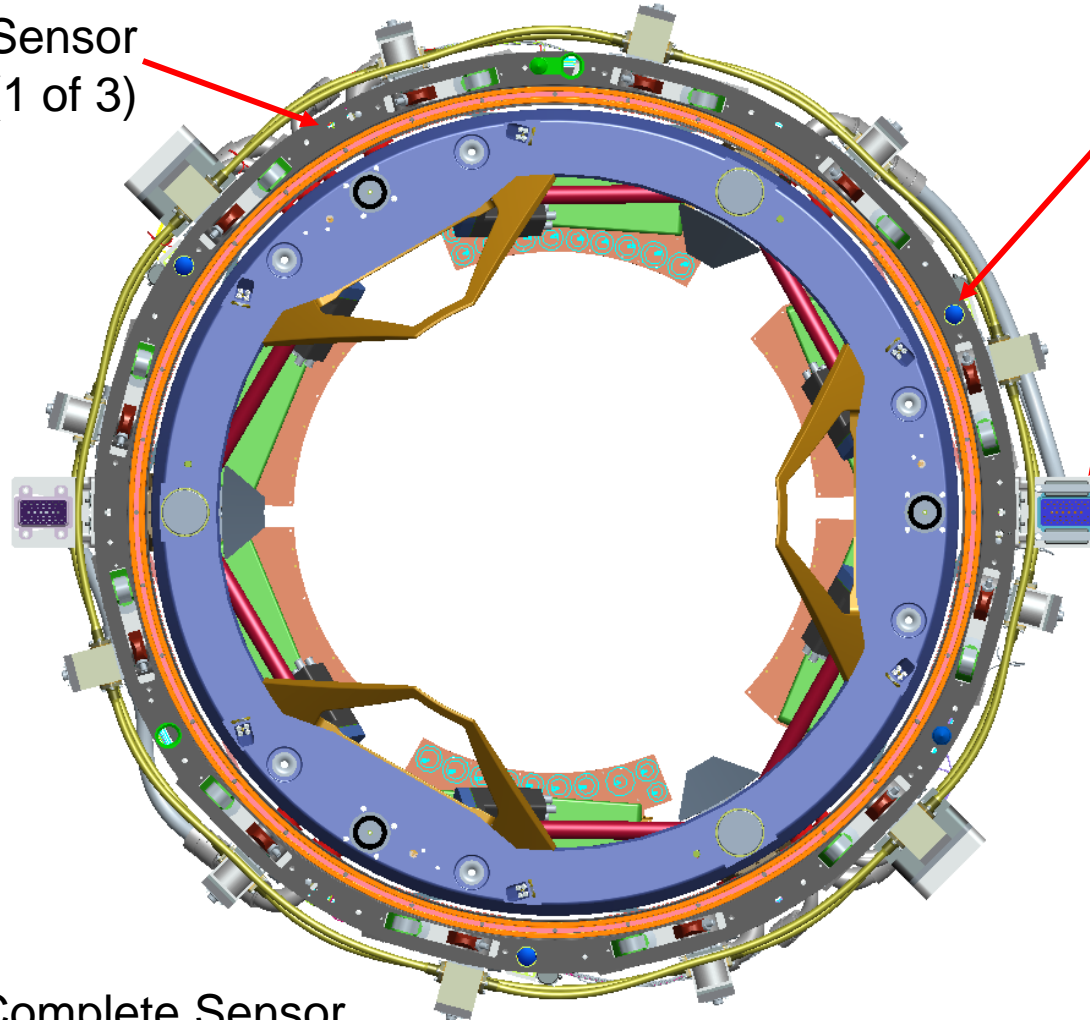

Motorized  
Separation System  
(1 of 3)

Motorized  
Power/Data  
Transfer Umbilical  
(1 of 2)

\*Undocking Complete Sensor  
(Qty and locations TBD)

- ◆ The IDSS IDD has established reserved areas for the APAS sensors and pushers in order to allow an APAS HCS to structurally mate with IDSS compatible systems.

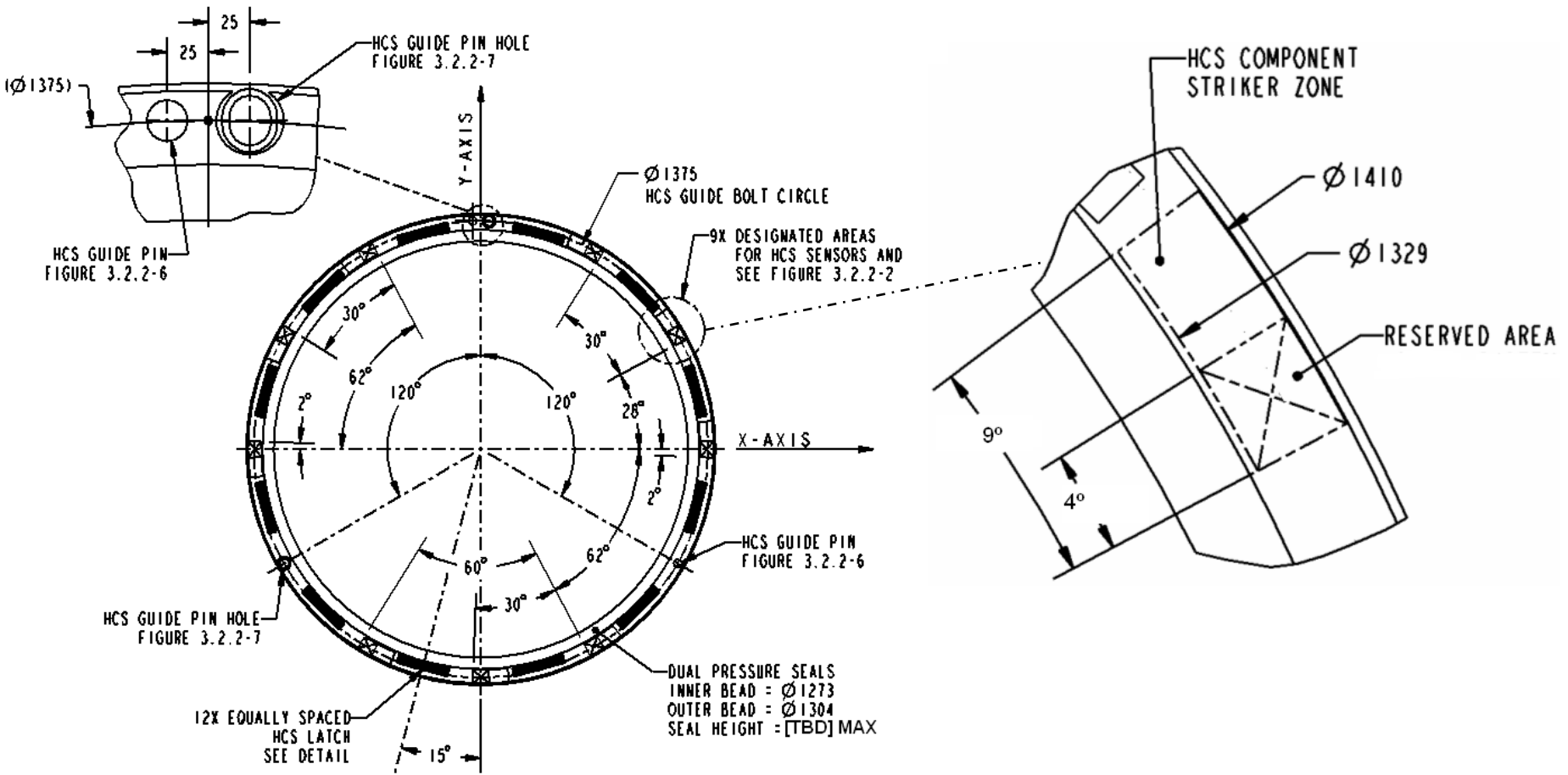

◆ The Hard Capture Subsystem (HSC) Docking Sequence

- Ready To Hook sensors trip when HCS mating surfaces are within 4mm
- Nominally, 12 active hooks are driven in gangs of six to engage with the passive hooks on the mating system
  - Provides structural connection ready for pressurization between the mated vehicles
  - Additional gangs on mated vehicle may be used in the event of failure or to achieve increased load capability with 24 connection points
- Once structural mate is complete:
  - Spring-loaded separation system is energized (compressed)
  - Mechanized resource transfer umbilicals are extended and engaged
    - Two umbilical (SSQ22680) [FRAM type connectors](#) that support both power and data transfer in the same connector shell
      - Independent 8 AWG pins in each umbilical for power transfer
        - ISS will provide either 120 or 28 VDC power to visiting vehicles
      - Separate pins for MIL-STD-1553B Single Bus (A and B) and 100 Base T Ethernet interface transfer
        - Engaging the umbilicals depresses a data bus transfer switch which allows MIL-STD-1553B communication transfer

- ◆ The Hard Capture Subsystem (HSC) Undocking Sequence
  - Power/Data Umbilicals are retracted
    - Once retracted, the data transfer bus terminates the MIL-STD-1553B connection
  - Active hooks are driven to release structural connection
    - In the event of failure to release hooks, pyrotechnic bolts can be fired (excluding -302 and -304) to release hooks
  - Spring-loaded separation system induces an initial separation force of 551 lbs (250 kgf) minimum and 595 lbs (270 kgf) maximum.
    - The separation system has sufficient capability to overcome seal stiction and to demate umbilical connectors if they fail to retract
  - Undocking complete sensor is tripped when the HCS mating surfaces are separated enough to ensure guide pin will clear receptacles





## Hard Capture Mated Loads : IDSS Compatible

### Table 1. HCS Maximum Mated Loads

	<b>Mated ISS</b>	<b>Trans-Lunar</b>
Maximum Design Pressure	15.95 psi (1100 hPa)	0 psi (0 hPa)
Seal Closure Force	137 lbf/in (24 000 N/m)	137 lbf/in (24 000 N/m)
Compressive Axial Load	3979 lbf (17 700 N)	67443 lbf (300 000 N)
Tensile Axial Load	3979 lbf (17 700 N)	22481 lbf (100 000 N)
Shear Load	3754 lbf (16 700 N)	2248 lbf (10 000 N)
Torsion Moment	11063 ft*lbf (15 000 Nm)	7376 ft*lbf (15 000 Nm)
Bending Moment	50671 ft*lbf (68 700 Nm)	29502 ft*lbf (40 000 Nm)

### Notes for Table 1 and Table 2

- 1.Values are design limit loads.
- 2.Hard capture hook preload and tunnel stiffness will be such that, when under external loading within limits, there remains metal-to-metal contact in the local vicinity of the hooks as specified in SSP 30559, Structural Design and Verification Requirements .
- 3.Seal closure force to be included in all cases in Table 2.
- 4.Cases 1 through 3 in Table 2 are pressurized mated cases.
- 5.Case descriptions:
  1. Case 1 – Attitude control by Orbiter-like, combined with crew activity.
  2. Case 2 – Berthing of ISS segment while mated.
  3. Case 3 – Orbiter-like translation with payload attached to ODS.
  4. Case 4 – TLI-like, modified from Constellation analysis. Not pressurized

### Table 2. HCS Mated Load Sets

<b>Load Set</b>	<b>Case 1</b>	<b>Case 2</b>	<b>Case 3</b>	<b>Case 4</b>
Compressive Axial	1124 lbf (5000 N)	3979 lbf (17 700 N)	3080 lbf (13 700 N)	67443 lbf (300 000 N)
Tensile Axial	1124 lbf (5000 N)	3979 lbf (17 700 N)	3080 lbf (13 700 N)	22481 lbf (100 000 N)
Shear	1124 lbf (5 000 N)	3327 lbf (14 800 N)	3754 lbf (16 700 N)	2248 lbf (10 000 N)
Torsion	7376 ft*lbf (15 000 Nm)	7376 ft*lbf (15 000 Nm)	7376 ft*lbf (15 000 Nm)	7376 ft*lbf (15 000 Nm)
Bending	50671 ft*lbf (65 300 Nm)	28912 ft*lbf (39 200 Nm)	50671 ft*lbf (68 700 Nm)	29502 ft*lbf (40 000 Nm)

◆ Electronics Box location

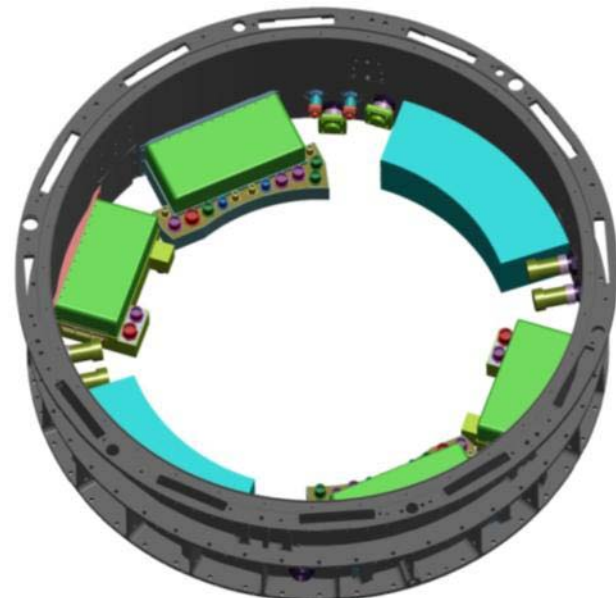
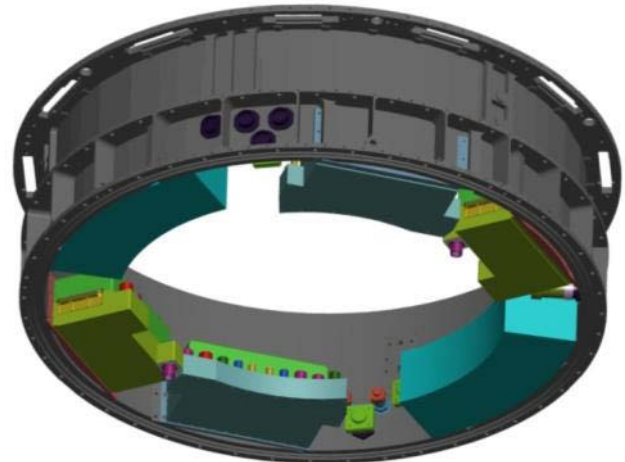
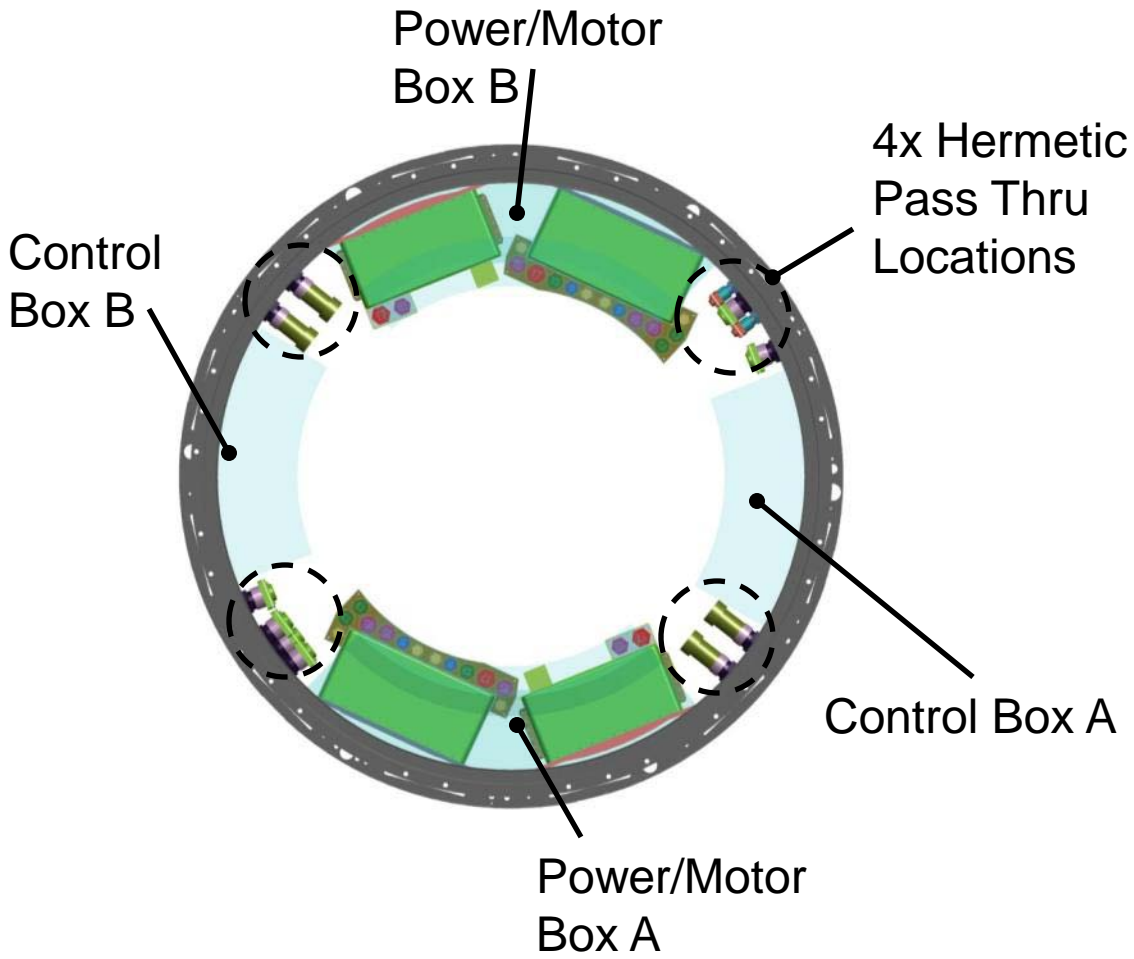

# NASA Docking System (NDS) Block 0 Configurations



Dash Number	NDS (-301)	NDS (-302)	NDS (-303)	NDS (-304)
<b>Configuration Differences</b>				
<b>Status</b>	<b>In Development</b>	✓	<b>Avail on Request</b>	<b>Avail on Request</b>
<b>Specification Max Weight (lb)</b>	750	704*	✓	711
<b>Host Power</b>	120 VDC	✓	28 VDC	✓
<b>NDS Tunnel Height (in.)</b>	15	TBD	✓	✓
<b>Dynamic Seal or Seal Surface</b>	Seal	Seal Surface	✓	✓
<b>Host Leak Check Port</b>	NDS Tunnel	Host tunnel	✓	✓
<b>Separator Striker Interface</b>	Integral to NDS	TBD	✓	✓
<b>Power &amp; Data Umbilical Interface</b>	Integral to NDS	On Host Structure	✓	✓
<b>SCS Magnet Striker</b>	Yes	✓	✓	No
<b>Hooks</b>	12 Active/Passive	✓	✓	12 Active
<b>Pyrotechnic Hook Release</b>	Yes	No	✓	No
<b>Electrical Boxes Mounting</b>	Integral to NDS	Mounted to Host	✓	✓
<b>Electrical Cable Length/Routing</b>	Integral to NDS	Host specific routing	✓	✓
<b>Hermetic Pass Thru for NDS control</b>	Integral to NDS	In Host Structure	✓	✓
<b>MMOD Shield</b>	Integral to NDS	Host Provided	✓	✓
<b>Passage Way Closeout</b>	Integral to NDS	Host Provided	✓	✓
<b>Life</b>	231 days	15 Years	✓	✓
<b>Active Docking Cycles</b>	2	Future capability	✓	✓
<b>Passive Docking Cycles</b>	50	✓	✓	None
<b>Other Key Interfaces</b>				
<b>S/W Interface to Host</b>	EIA422 or MIL-STD-1553	✓	✓	✓
<b>Comm Channels to Host (NDS control and heater control)</b>	One comm channel for A & one for B	✓	✓	✓
<b>Motorized Transfer Umbilicals</b>	Power and Data	✓	✓	✓
<b>Motorized Separation System</b>	Yes	✓	✓	✓

Ready to Dock (Active Mode)  
Soft Capture System Extended

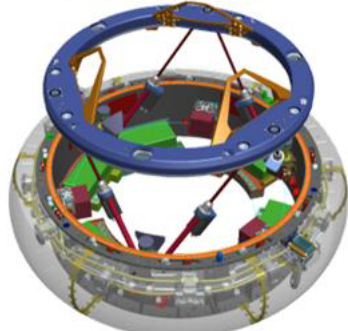

Ready to Dock/Launch  
(Excluding -302 Passive Mode)  
Soft Capture System Retracted

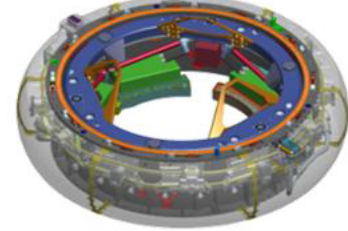

Ready to Dock/Launch  
(-302 Passive Mode)  
Electrical Boxes mounted in host

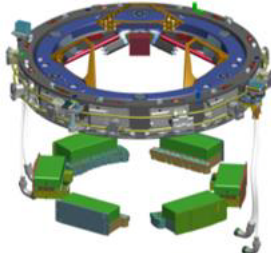

- Configuration Description**
- ◆ 301: Core: 120VDC power, integrated electronics
  - ◆ 302: Short: Reduced height; electronics boxes remotely mounted
  - ◆ 303: Low Voltage: Same as 301 except 28VDC power input
  - ◆ 304: Abated: Same as 301 except reduced functionality/reduced mass, selected missions
- \*Complete -302 integration mass requires a host provided components of ~65 lb

**Legend** ✓ Indicates config is same as -301

## ISS Common Docking Adapter (CDA) – ISS Location

For ISS missions, the Visiting Vehicle (VV) will carry an active NDS, and will dock to the CDA.

Current planned locations:

- Node 2 Forward
- Node 2 Zenith

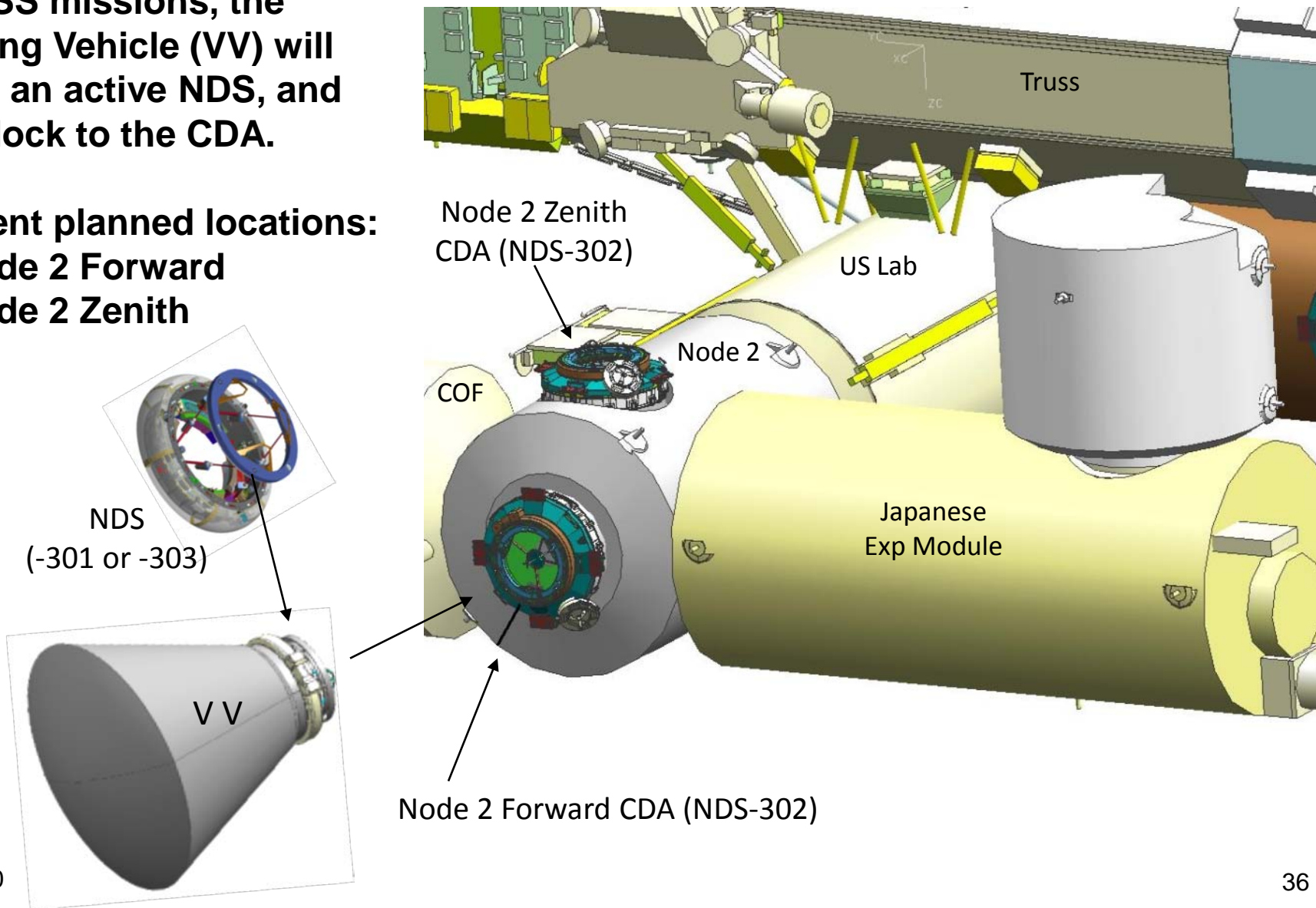

## NDS (-302) on CDA for Visiting Vehicle (VV) Docking

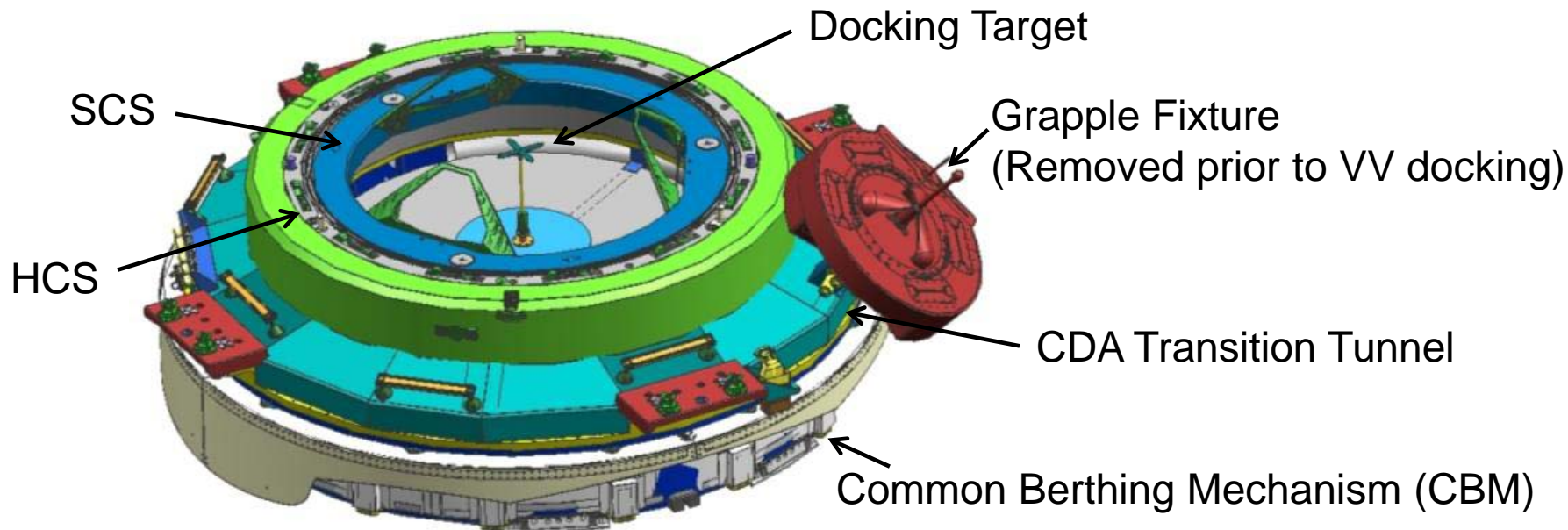

- ◆ The NDS (-302) is part of the larger CDA element mounted on ISS and consists of an NDS SCS and HCS
  - NDS (-302) has active SCS but will not be initially certified for active mode
    - Nominal ops: VV NDS in active mode to dock to the CDA NDS in passive mode
  - The HCS structurally mates the two vehicles & seals for pressurization
    - For ISS, docking seals are on the VV; the NDS (-302) has only a flat mating flange
  - CDA also includes a docking target for VV relative navigation systems



# Hardware Demonstration/Viewing

*Monty Carroll  
NDS Chief Engineer*





# Software Overview

*Steve Duran*  
*NDS Software Lead Engineer*





# Software Overview – Top Level Architecture



deployment LIDS SW Architecture

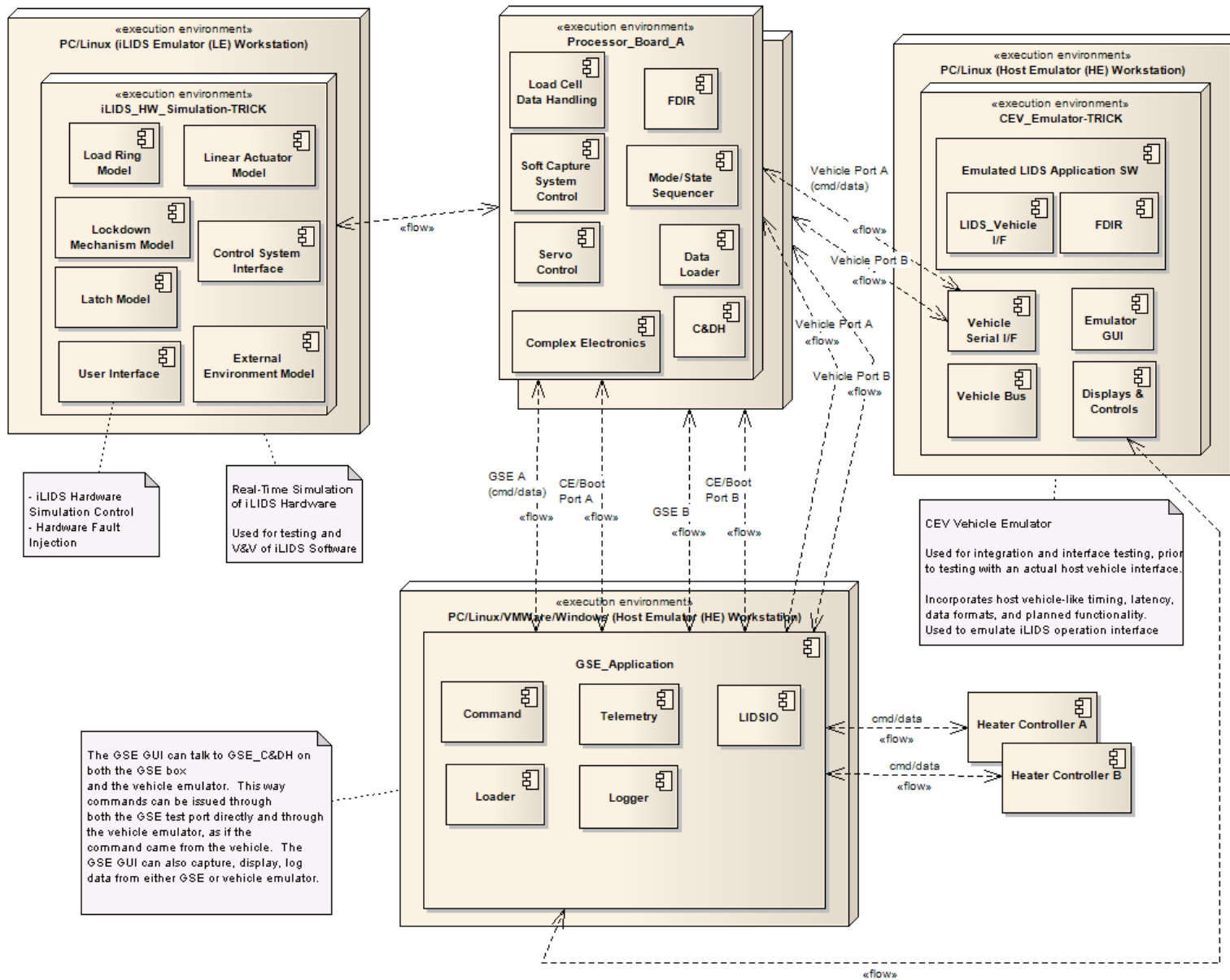





- ◆ Software running in the host vehicle has to perform the following functions to interface to iLIDS
- ◆ Command Handling
  - Receive iLIDS commands from host vehicle data systems (D&C, C&DH)
  - Possible format for iLIDS (depends on how host vehicle defines commands)
  - Forward commands from host vehicle to iLIDS through iLIDS interface
- ◆ Health & Status Data Handling
  - Receive H&S data packets from iLIDS through iLIDS interface
  - Possibly format from iLIDS packet to host vehicle C&DH format
  - Forward H&S data to D&C, Logging, Telemetry
- ◆ Some FDIR handling
  - Some FDIR logic will be required to be implemented in host vehicle computing systems, mainly to perform primary to backup string switching
  - Monitor for loss of heartbeat (in H&S) or fault indicator from iLIDS that requires strings to be switched
    - Total time allocated to host vehicle for H&S data to move through vehicle systems and switch command to be received by LIDS is 120 ms



- ◆ Currently, communication with the host vehicle via standard RS422 Universal Asynchronous Receiver/Transmitter, UART, protocol,
- ◆ 1553 interface being added
- ◆ The interface consists of passing commands from the host vehicle to iLIDS and passing H&S data from iLIDS to the host vehicle
- ◆ Commands from host vehicle are used to initiate dock/undock sequence
  - Host vehicle implementation will determine whether commands can be routed from the crew, ground, or other vehicles
  - Command responses are then sent to the host vehicle as part of the periodic health and status data at 50 Hz
    - iLIDS will proceed through sequence without further intervention unless a fault is detected or pause/terminate commands are issued
    - iLIDS will report faults to the host vehicle and relies on host vehicle to initiate next action (e.g. switch from channel A to channel B control)



## Example list of NDS Commands

Command	Valid Modes	Valid States
LIDS_CMD_ENABLE_DOCK	Safe	idle
LIDS_CMD_EXECUTE_DOCK	Safe	idle
LIDS_CMD_SCS_EXTEND	Checkout, Dock, Undock	Checkout(Unlock), Dock(Unlock), Undock(Unlatch)
LIDS_CMD_SCS_HOLD	Dock	Extend
LIDS_CMD_LOADCELL_CAL	Dock, Engineering	Dock(Hold), Engineering(All)
LIDS_CMD_SCS_CAPTURE	Dock	Hold
LIDS_CMD_SCS_ATTENUATE	Dock	Capture
LIDS_CMD_SCS_ALIGN	Dock	Attenuate
LIDS_CMD_SCS_RETRACT	Dock	Align
LIDS_CMD_HCS_LATCH	Dock	Retract
LIDS_CMD_SCS_STOW	Checkout, Dock, Undock	Checkout(Motion Check), Dock(Rigidize), Undock()
LIDS_CMD_SCS_HOME	Checkout, Dock, Undock, Engineering	Dock(), Engineering(All)

- ◆ The detailed definitions of all the NDS software commands and data items are contained in JSC 65975, NDS IDD.
- ◆ 3 “types” of commands
  - Mode control (system operates automatically within modes)
  - Manual commands (manually step through auto sequences)
  - Engineering Commands



- ◆ Current (for RS-422 interface, 1553 interface being added) NDS communications consists of two application level packet structures that include a command packet and a Health and Status packet. The packet formats are CCSDS packet format.
  - The command packet will be used by the host vehicle to command the NDS operations.
    - The command packet has a size of 58 Bytes.

## Host Vehicle-to-NDS Command Packet

Primary Header						Packet Data Field				
						Secondary Header			Payload	
Packet Version (3 bits)	Packet Identification			Packet Seq. Control		Packet Data Length (16 bits)	Time-stamp (64 bits)	Cmd ID (16 bits)	Rsvd (16 bits)	Payload (40 Bytes)
	Packet Type (1 bit)	Sec. Hdr. Flag (1 bit)	App. ID (11 bits)	Seq. Flags (2 bits)	Seq. Count (14 bits)					

- ◆ The Health and Status packet includes command responses and measurements.
  - Periodic Health and Status data to the host vehicle at a rate of 50 Hz.
  - The H&S packet has a max size of 1024 (TBC-4) Bytes.

## NDS-to-Host Vehicle Health and Status Packet

Primary Header						Packet Data Field					
						Secondary Header				Payload	
Packet Version (3 bits)	Packet Identification			Packet Seq. Control		Packet Data Length (16 bits)	Time-stamp (64 bits)	Cmd Resp ID (16 bit)	Cmd Resp Type (8 bits)	Rsvd (8 bits)	Payload (998 Bytes Max)
	Type (1 bit)	Sec. Hdr. Flag (1 bit)	App. ID (11 bits)	Seq. Flags (2 bits)	Seq. Count (14 bits)						



- ◆ Software Modes
- ◆ Commands are issued to change LIDS modes of operation
  - Active Docking and Undocking Modes
    - Controls Docking/Undocking sequence
  - Passive Docking and Undocking Modes
    - Provides H&S and controls passive mode actuators
  - Safe Mode
    - Provides all health and status data. In addition, all outputs will be inhibited during operation (e.g. motors, magnets, etc.)
  - Check-out Mode
    - Moves the soft capture system through a predetermined sequence of positions and returns to the stowed configuration
  - Engineering mode
    - Supports troubleshooting without the constraints of all other modes
    - For example, Engineering mode will allow the user to command a single motor on/off. It is critical to adhere to proper procedures during this mode



# NDS Major Systems Interfaces & Integration Information

*George Parma*  
*NDS Project SE&I Manager*





# NDS Major System Interfaces

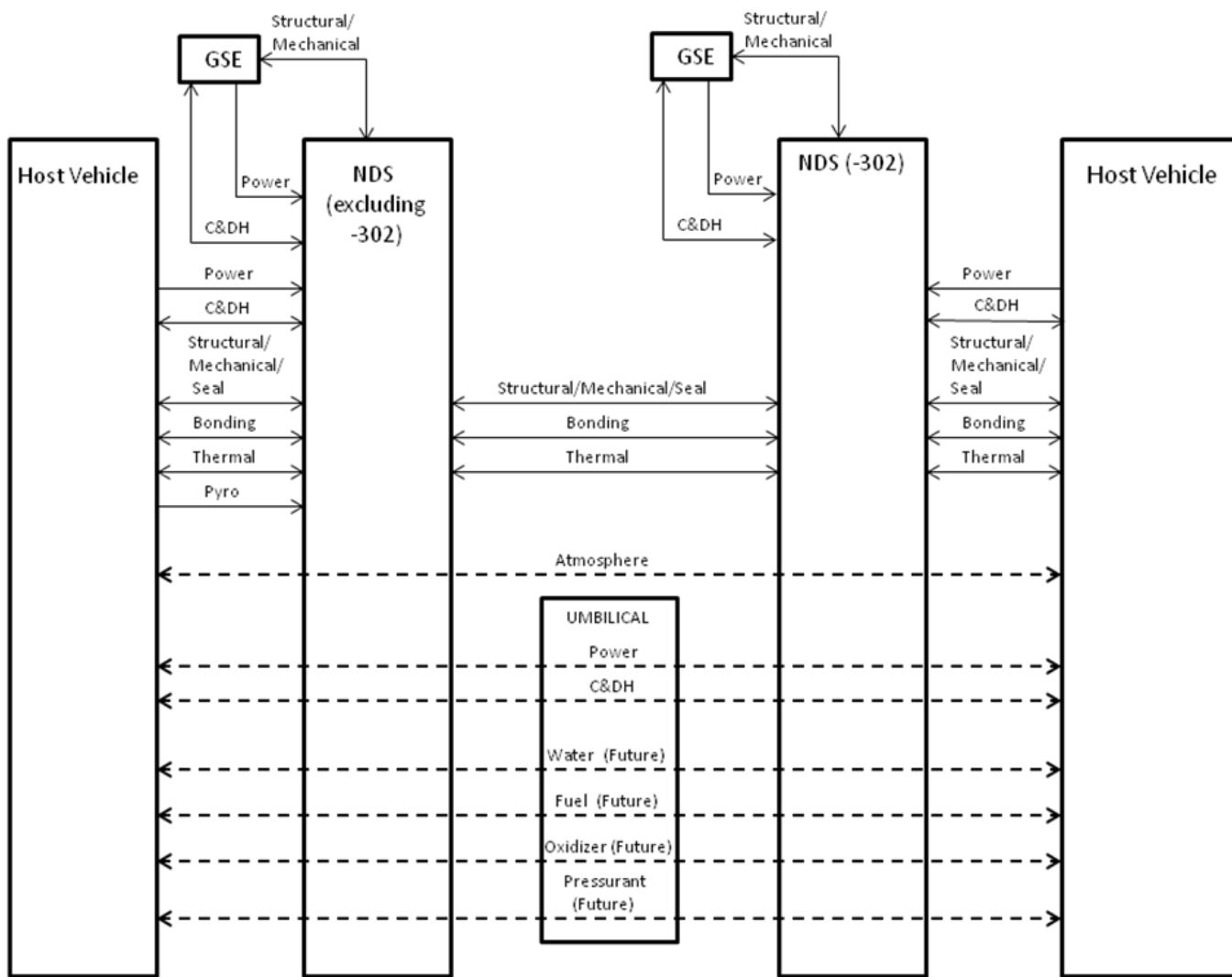

## System Functional Interface Diagram

————— Solid lines = functional interfaces  
 - - - - - Dashed lines = pass through resources vehicle to vehicle  
 \* Pyro is not available on -302 or -304



## ◆ Structural/Mechanical

- Mounting Interface to Host Vehicle (based on APAS host vehicle interface)
  - NDS attaches to a bolt and seal interface flange on Host Vehicle (HV)
  - [48-bolt circular arrangement of fasteners](#)
  - 3 shear pins (not part of APAS interface)
  - NDS will provide bolts
    - Host will provide inserts
- Seal Interface to Host Vehicle
  - Two concentric seals
    - NDS will provide seal beads
    - Host Vehicle to provide seal land and mating surface finish

## ◆ Resource Transfer Umbilicals

- Two mechanized umbilical connectors for Power and Data
  - [FRAM type connector](#)
- Two circuits of 8AWG wiring for power transfer
- Separate pins for MIL-STD-1553B and 100 Base T Ethernet
- NDS will provide umbilical electrical characteristics (voltage drop, frequency response etc..)





## ◆ Electrical Interfaces

- NDS System Power
  - NDS receives 120 VDC (initial configuration) or 28 VDC from HV
    - Must be specified prior to delivery of NDS to Host
  - Redundant power feeds: System A and System B; estimated consumption:
    - System A: 220 W nominal, 1.4 KW peak
    - System B: 100 W nominal, 500 W peak
      - NOTE: Sys A and Sys B peaks are not simultaneous
  - Power quality requirements and timeline will be provided by NDS
- NDS System Data
  - NDS receives C&DH from Host vehicle
  - Two independent serial interfaces using either standard TIA-422-B or MIL-STD-1553B
  - Health and Status transmitted at 50Hz
- NDS Heater Power and Heater Controls
  - Requires up to 400 W additional power consumption at 120VDC
    - Separate from NDS power feeds but in the same connectors
  - One channel active while other is in standby
  - Control through the same TIA-422-B or MIL-STD-1553B channels as NDS C&DH



- ◆ **Electrical (con't)**
  - **Pyrotechnics**
    - NDS (-301 and -303) has pyrotechnics in both active and passive hooks used for contingency un-docking
    - Control provided by Host Vehicle separate from NDS C&DH, and in stand-alone connectors
  - **Bonding**
    - Class R, bond resistance < 2.5 milliohms
      - Achieved through chemical conversion coat at seal interface
- ◆ **Temperature range**
  - -38 °F to +122 °F (-30 °C to +50 °C) Operational
  - 65 °F to +192 °F (-50 °C to +89 °C) Non-Operational
- ◆ **GSE**
  - **Mechanical**
    - 6 lifting points
  - **Maintenance and Ground Operations**
    - 1 Connector on NDS control box dedicated for maintenance and ground ops
      - Corresponding testing hardware and software will be supplied
  - NDS will provide GSE software with Graphical User Interface (GUI)

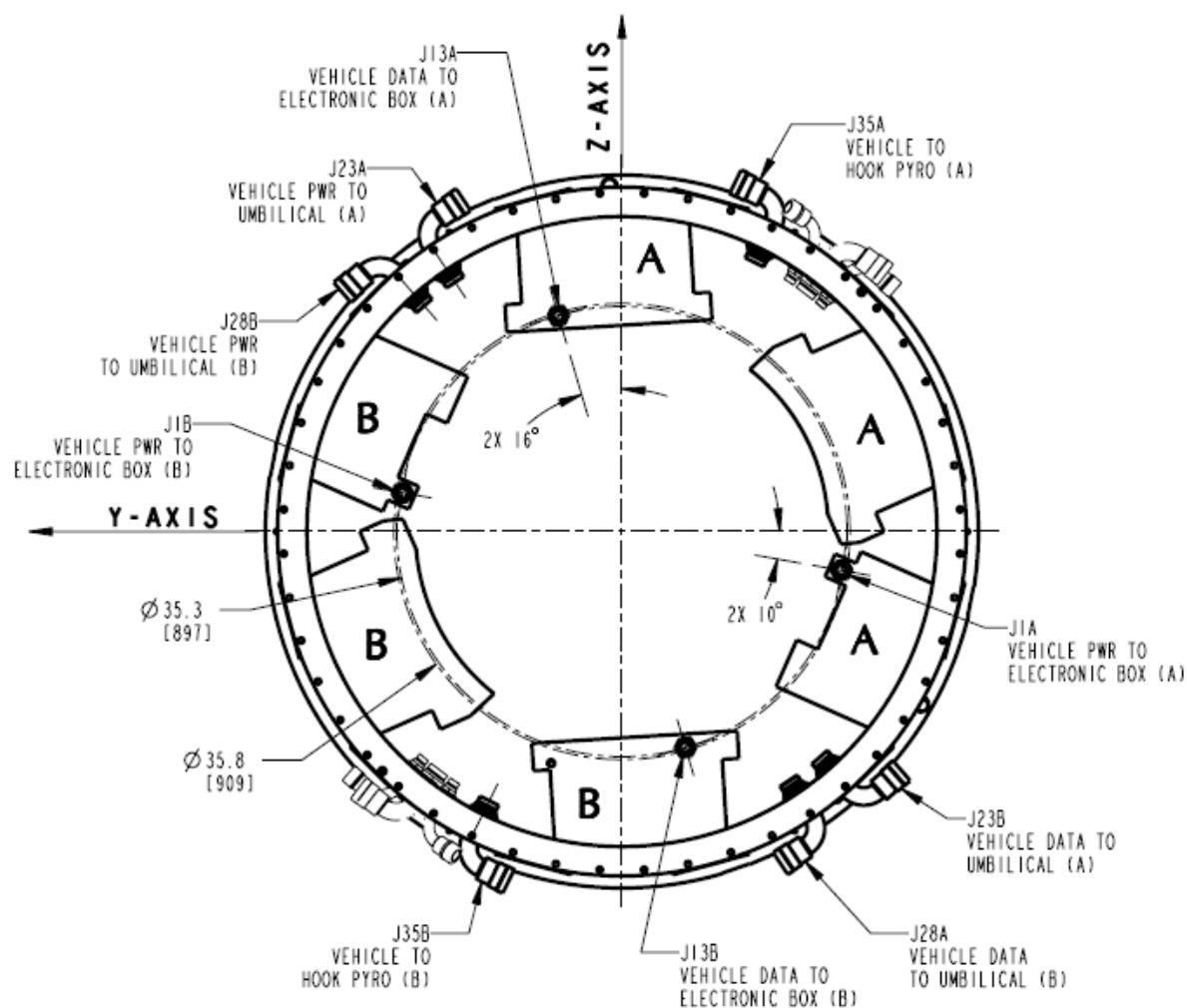

NDS (excluding -302) to Host Vehicle Electrical Interface



## A change in docking systems is coming to the ISS USOS

- ◆ Current docking adapters on the USOS are Pressurized Mating Adapters (PMA)
  - Docking port is a Russian Androgynous Peripheral Assembly System (APAS)
- ◆ The ISS Program plans to deliver and install two CDA's, beginning in late 2014
  - CDA #1 at Node 2 forward in late 2014
  - CDA #2 at Node 2 zenith in 2016
- ◆ Some notable differences between a PMA and a CDA:
  - PMA docking port is 28" off of the Node hatch centerline, CDA docking port is on centerline
  - PMA is 94.1" long, CDA is 26.4" long
  - PMA incorporates an internal pressure hatch, CDA has no hatch



- ◆ The NDSP will provide integration support for HV's using the NDS
- ◆ Analytical models will be available for HV's to integrate into their vehicle models to perform integrated analysis
  - ◆ Thermal
  - ◆ Structural
  - ◆ Simplified volumetric CAD models for geometric integration
- ◆ NDSP plans to build a -301 mass simulator with dummy connector interfaces, useful for modal/acoustic testing & fit checks
- ◆ A LIDS Emulator (LE) system will be available for HV power, avionics & software interface test/verification
  - ◆ Provides proper command/response and power timeline loading
  - ◆ Can inject faults into its operation to test a vehicle's response
- ◆ NDS GSE (for ground test, lifting & handling fixtures) will be available
- ◆ Docking system interface fit check tools will be available
  - ◆ Both -301 and -302 units
  - ◆ Used primarily for fit check of each new system as part of the NDS acceptance process, but could be made available for fit check if a spacecraft developer chooses to build and certify their own system



- ◆ Docking System capture & performance analysis will be performed by NASA
  - ◆ Expertise in docking systems modeling going back to Apollo-Soyuz
  - ◆ NASA possess excellent APAS models for Orbiter Docking System and regularly performs orbiter docking analyses
  - ◆ Currently characterizing NDS, and will have fully test verified models
- ◆ Capture analysis will determine whether the docking system will be able to achieve capture, given various docking conditions
  - ◆ Monte Carlo based
  - ◆ Requires HV's mass properties and GN&C performance capability
- ◆ Performance analysis will determine resultant loads under the above conditions, and verify they are within the system's certified capability
- ◆ Can iterate on Initial Capture Conditions (ICC's) to develop a solution that satisfies both Chaser and Target vehicle requirements



## Fault Tolerance

- ◆ The NDS is designed to be 2-fault tolerant (FT) for catastrophic hazards (i.e., loss of crew or vehicle), as defined by the ISS
- ◆ The NDS is designed to be 1-FT to all critical hazards (i.e., loss of mission), as defined by the ISS
- ◆ In certain cases, the docking system alone will not provide the full FT
  - ◆ The NDS depends upon additional functionality from either the ISS or its HV to meet the full fault tolerance requirements (see examples on next slide)
  - ◆ The functionality that is expected to be provided by the Host Vehicle is delineated in the NDS IDD



## Fault Tolerance - Continued

- ◆ Example of the shared responsibility for certain FT
  - ◆ The NDS system architecture employs 2 electrical/control channels with single mechanical output
  - ◆ If primary channel fails, then Host Vehicle must command the secondary channel to become primary, then docking continues autonomously
  - ◆ If second channel fails, then Host Vehicle or ISS takes action to mitigate failure
    - ◆ Examples are
      - ◆ Host Vehicle aborts docking attempt
      - ◆ Host Vehicle fires pyros to undock (via manual command, after second failure)
      - ◆ CDA performs backup function e.g. charges separation system from ISS side (via manual command)





- ◆ NDS will provide appropriate integration documentation for Host Vehicles, such as: [\(See more detailed description\)](#)
  - SSP 50920 “NDS User’s Guide”
  - JSC-63686 “Project Technical Requirements Specification for the International Low Impact Docking System (iLIDS)”
  - JSC-65795 “NDS Interface Definitions Document (IDD)”
  - NDS Drawings & Model data
  - Safety & Hazard reports
  - Verification and Validation Document (V&VD) / Acceptance Data Package (ADP)
- ◆ Check the NDS TIM web site (<http://procurement.jsc.nasa.gov/ndsid/>) , or the NDS public web site (<http://dockingstandard.nasa.gov/>) for availability information on these documents

- ◆ JSC will perform the entire certification process using its in-house environmental (and other) test facilities
- ◆ JSC also possesses a unique Six-degree-of-freedom Dynamic Test System (SDTS) for hardware-in-the-loop testing under simulated docking conditions



- ◆ Located in JSC Building 9
- ◆ Closed loop dynamic testing system that combines test articles and software models to produce an integrated simulation of two-body contact in free space
- ◆ Provides a six degree-of-freedom motion base platform, a superstructure for mounting test articles, test sensors, motion tracking system, camera systems, and a high speed data acquisition system
- ◆ NDS will use this facility to test verify its math models for docking capture and performance



# Schedule & Future Upgrades

*James Lewis*  
*NDS Manager*





# Schedule

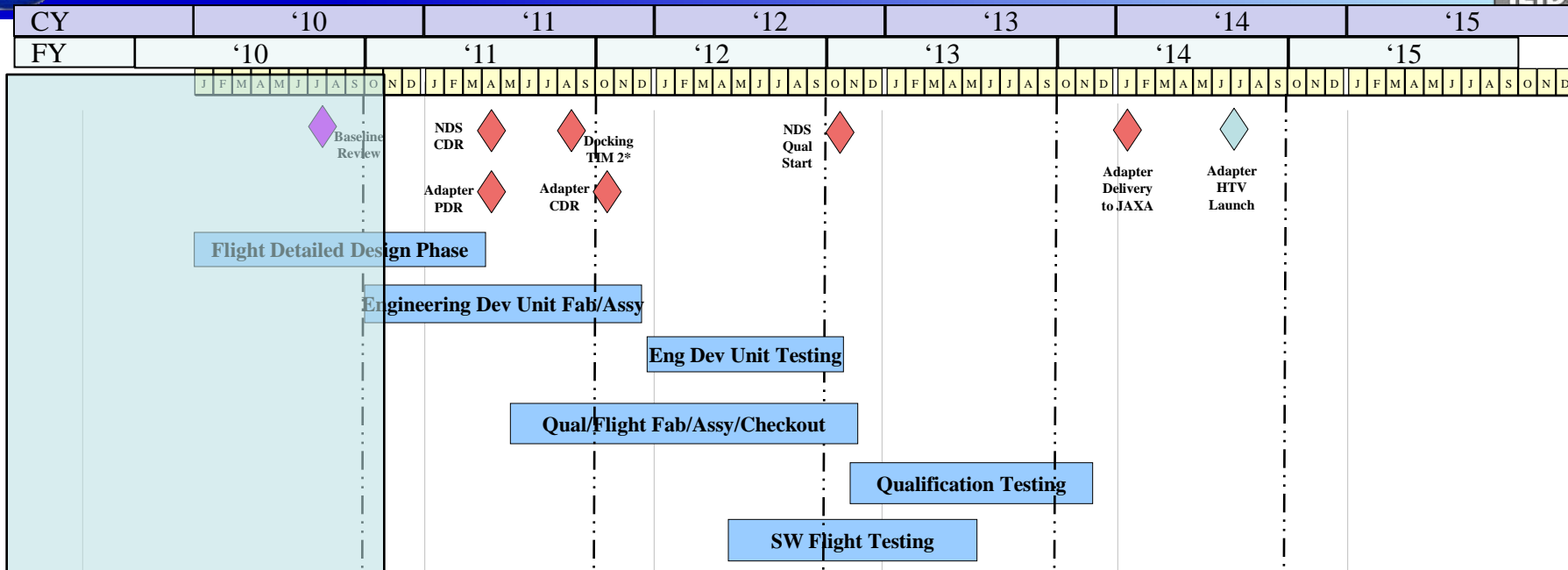

- NDS Critical Design Review (CDR) Apr-2011
- CDA Preliminary Design Review (PDR) Apr-2011
- Visiting Vehicle Data TIM (\*Tentative) Aug-2011
- CDA Critical Design Review (CDR) Oct-2011
- NDS Engineering Development Unit (EDU) Testing Complete
  - Component Dec-2011
  - EDU Oct-2012
- NDS Qualification Testing Complete Jan-2014
  - Approximately 1 year of Testing
- CDA delivered to ISS via HTV launch Jul-2014



- ◆ Certain additional functionality is not needed for the initial envisioned applications. These items are candidates for a future block upgrade to the NDS, such as:
  - Umbilical to support transfer of water, fuel, or pressurant and oxidizer
  - NDS with passive capture interface but with active hooks
  - Super-Lightweight passive NDS
  - User Defined (e.g., voltage, communication)
- ◆ Certify berthing capability
- ◆ Active NDS on ISS



# Questions and Answers





# Backup



**New “K” Insert Layout  
(Power Connector currently assumed as a  
combined power/data connector for the  
NDS)**

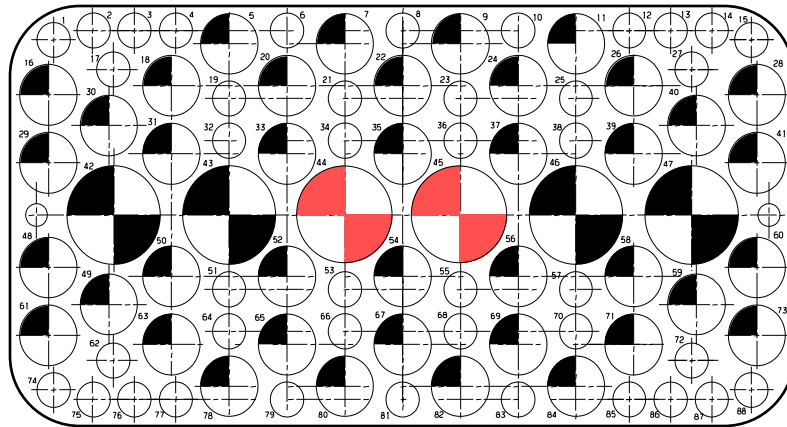

Front face of plug insert shown, receptacle opposite

Plug - SSQ22680-021;  
Receptacle- SSQ22680-022;  
Backshell - SSQ22680-10-004

Shell Size	Arrangement Type	No. Of Contacts	Contact Mate size	Contact Barrel Size	Symbol
1	K	6	8	8	
		40	12	12	
		42	20	20	

[Return to HCS Description](#)

[Return to Major Interfaces](#)





- ◆ SSP 50920 “NDS User’s Guide”
  - High-level description of the NDS and its interfaces (details are given in the NDS IDD)
  - Useful for initial integration planning for users of the NDS
- ◆ JSC-63686 “Project Technical Requirements Specification for the International Low Impact Docking System (iLIDS)”
  - Defines the technical requirements for the NDS Government Furnished Equipment (GFE)
  - Also includes requirements for the Passive NDS components delivered as part of the Common Docking Adaptor (CDA) project
- ◆ JSC-65795 “NDS Interface Definitions Document (IDD)”
  - The NDS Interface Definition Document (IDD) defines the interface characteristics and performance capability of the NDS
  - This document defines the NDS-to-NDS interfaces, as well as the NDS-to-host vehicle interfaces and performance capability
- ◆ NDS Drawing & Models
  - Structural, Thermal, etc.
- ◆ Verification and Validation Document (V&VD)
  - Documents the verification & validation of each requirement from the PTRS
    - Identifies verification criteria and method
    - Documents verification & validation confirmation

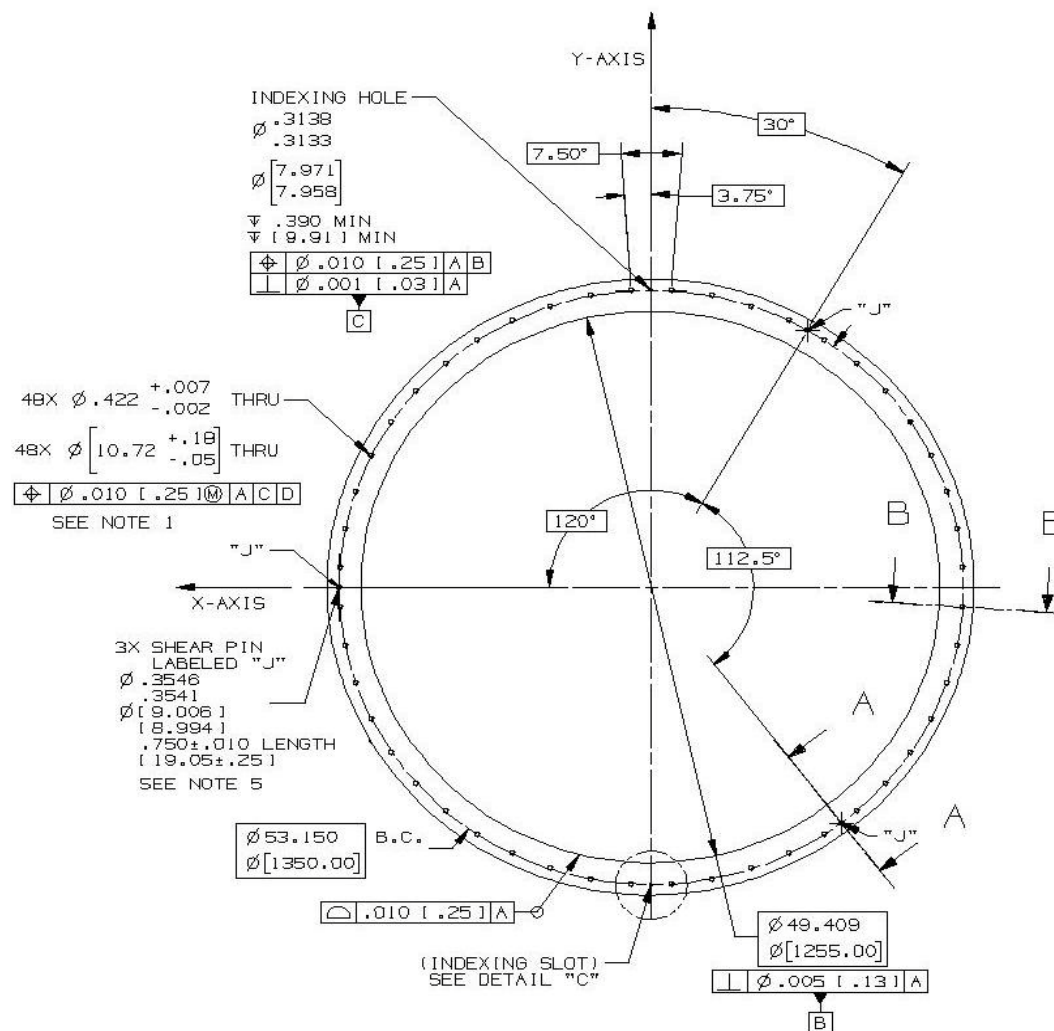

VIEW LOOKING TOWARD NDS MATING FLANGE INTERFACING ELEMENT. (O-RINGS GROOVES OMITTED FOR CLARITY)