

Magazine for  
DMG MORI  
customers and  
interested readers

19 global premières in 2014,  
including 10 global premières  
in the last six months –  
introduced in this journal.

DMG MORI is the  
exclusive premium partner  
of the Porsche team  
in the LMP1 class.

DMG MORI Systems  
Innovative automation  
concepts thanks  
to focused skills.

**DMG MORI**

N° 2 – 2014

# Journal

Tradition, precision  
and innovation



DMG MORI is  
the exclusive  
premium partner  
of the Porsche  
LMP1 team.



**GLOBAL PREMIÈRE**  
The 2<sup>nd</sup> generation  
of the NHX range:  
the NHX 4000 and  
NHX 5000.

Maximum cutting perfor-  
mance with the new  
speedMASTER spindle:  
200 Nm (40 % ED)  
or 20,000 rpm.

→ More on **PAGE 8**

**CELOS**  
from DMG MORI

[www.dmgmori.com](http://www.dmgmori.com)



INNOVATION YEAR 2014

# 19 global premières in 2014, 10 of which are in the second half of the year.

19 global premières in 2014 attest to the status of **DMG MORI** as the global leader in machine tool innovation. We will present 10 global premières in the second half of 2014. **CELOS** from **DMG MORI** and the new **DMG MORI design** are raising the bar for our customers. Take advantage of **innovative technological solutions** and the **top-class quality** of our machines and services.

## AN OVERVIEW OF 10 WORLD PREMIÈRES

- NHX 4000 2<sup>nd</sup> generation** – HORIZONTAL MACHINING CENTRE  
Unbeatable cutting performance, speed and precision
- NHX 5000 2<sup>nd</sup> generation** – HORIZONTAL MACHINING CENTRE  
Outstanding stiffness with a robust machine bed and spindle bearings with a large diameter
- i 50** – HORIZONTAL MACHINING CENTRE  
Highly productive, compact horizontal machining centre – ideal for mass-producing cylinder heads and blocks
- DMC 1450 V** – VERTICAL MACHINING CENTRE  
Large working area with 700 mm Y axis for workpieces weighing up to 2,000 kg
- DMU 125 P duoBLOCK® 4<sup>th</sup> generation** –  
UNIVERSAL MILLING MACHINE FOR 5-SIDED / 5-AXIS MACHINING  
Precision – up to 30% higher component precision
- DMU 270 FD** –  
UNIVERSAL MILLING MACHINE FOR 5-SIDED / 5-AXIS MACHINING  
Full machining at the top of the range – high-precision milling and turning of up to 7,000 kg
- NTX 1000 2<sup>nd</sup> generation** – TURN-MILL FULL MACHINING CENTRE  
High-efficiency turn & mill machining centre with the smallest set-up area of its class
- NRX 2000** – PRODUCTION TURNING MACHINE  
Highly productive dual-spindle turning centre for mass production with a workpiece loading time of just 4.2 seconds
- NZX 4000|3000** – PRODUCTION TURNING MACHINE  
High-efficiency 4-axis turning centre for machining large, long parts measuring up to ø 285 mm
- LASERTEC 45 Shape** – LASERTEC  
Highly compact machine concept with a large working area measuring 700 x 380 mm



All trends and innovations in 2014

[www.dmgmori.com](http://www.dmgmori.com)

If your mobile phone has a QR code reader, you can go straight to the homepage.



**CELOS**  
FROM DMG MORI

NLX 2500 | 500  
(BLACK VERSION)

## Journal 2 – 2014

All trend-setting developments and highlights from DMG MORI in 5 topic sections:



### PAGES 2-4 — Intro

Innovation year 2014. 19 global premières in 2014, 10 of which are in the second half of the year.



10 global premières in the second half of 2014

### PAGES 5-19 — Global premières and innovations

CELOS and Industry 4.0  
An overview of 10 global premières.





CELOS – FROM THE IDEA TO THE FINISHED PRODUCT



CELOS from DMG MORI simplifies and speeds up the process from the idea to the finished product.

**MORE ON PAGES 6–7** →

DMG MORI HIGH-TECH COMPONENTS

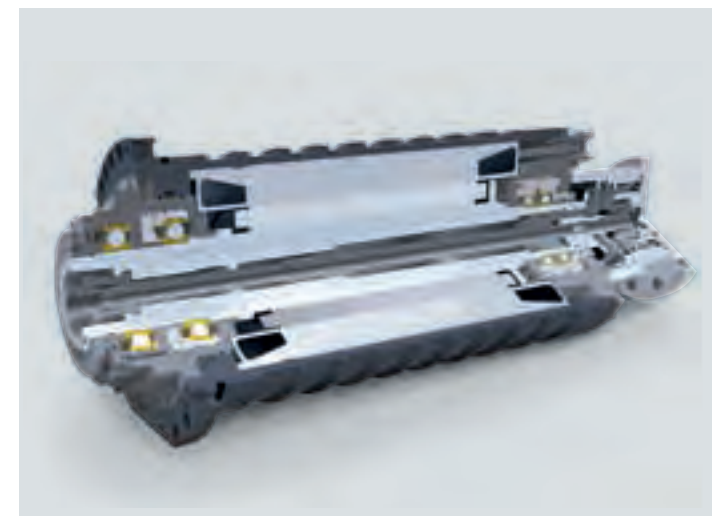

New: speedMASTER from DMG MORI.

**MORE ON PAGES 18–19** →



**DMG 650 V**  
(WHITE VERSION)

**CELOS**  
 FROM DMG MORI

The new DMG MORI design – multifunctional, user-friendly and value-retaining – available in either „BLACK“ or „WHITE“ at no extra cost.

SCHEDULE – KEY EVENTS IN 2014

- > IMTS, Chicago (USA)  
08 September–13 September 2014
- > AMB, Stuttgart (Germany)  
16 September–20 September 2014
- > MSV, Brno (Czech Republic)  
29 September–03 October 2014
- > BIMU, Milano (Italy)  
30 September–04 October 2014
- > MAKTEK, Istanbul (Turkey)  
14 October–19 October 2014
- > Grand Opening Shanghai (China)  
21 October–25 October 2014
- > JIMTOF, Tokyo (Japan)  
30 October–04 November 2014
- > PRODEX, Basel (Switzerland)  
18 November–21 November 2014
- > Euromold, Frankfurt (Germany)  
25 November–28 November 2014

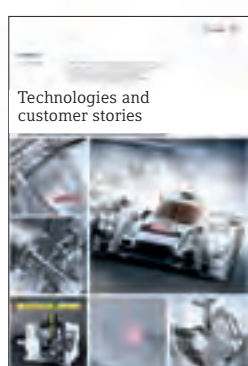

PAGES 21–36 — Technologies and customer stories

Innovative technologies from production turning to large part machining.

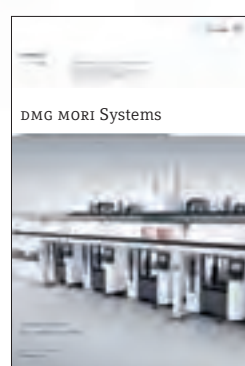

PAGES 37–44 — DMG MORI Systems

Intelligent production lines for Industry 4.0  
 Four reference reports and solutions from four automation areas.

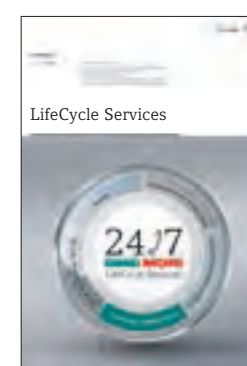

PAGES 45–52 — LifeCycle Services

Focusing on maximising productivity.  
 Software solutions.





eni lubricants and solutions  
for high-tech metalworking



technology comes alive

## eni downstream & industrial operations

cutting fluids and industrial lubricants

Based on its long experience and certified research laboratories, eni, leader in the Italian industrial lubricants market, has developed high tech metalworking products

- Aquamet - coolants
- Aster - mineral based neat cutting oils
- Metalcut - vegetable and biodegradable cutting oils

The partnership with DMG MORI calls for the use of eni lubricants, greases and cutting oils on all group's machine tools and encourages the development of new technological solutions for improving the customer's production and manufacturing processes.

eni downstream & industrial operations' commercial structure is available to identify the most suitable solutions for all lubrication needs in European countries.

eni downstream & industrial operations  
via Laurentina, 449 - 00142 Roma  
Ph.+39 06 5988.1 - eni.com

## 'Best in Class Winner'

Jungheinrich EFG S40s: The most efficient electric fork lift truck with the power of a diesel engine. With upto 28 per cent lower consumption than its competitors even under the harshest conditions. The best in its class.

More highlights: [www.jungheinrich.com](http://www.jungheinrich.com)



## Leading Supplier of Linear Technology

As the pioneer of the 'Linear Motion Guide', THK is constantly developing new products in its pursuit of the highest standards in terms of product precision and product rigidity. Both of which are paramount and vital to machine tool manufacturers.

THK products along with Caged Ball/Roller technology maximise machine performance, provide a longer service life and are locally available throughout the world. The benefits of using this technology include: a reduction in the frequency and cost of maintenance works and environment conservation with reduced energy consumption and lower dust emissions.

THK will continue to support machine tool manufacturers to further their success, by not only offering original and established technologies. But also by developing unique and new technologies, all over the world.

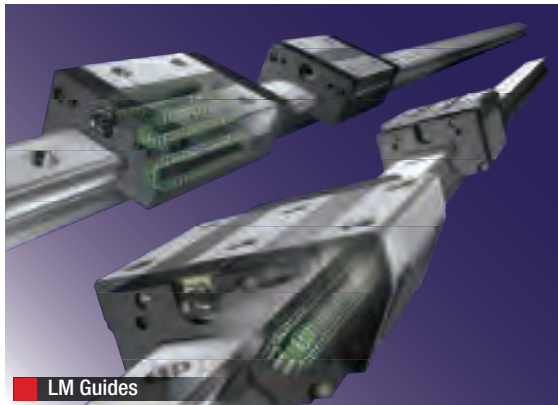

LM Guides

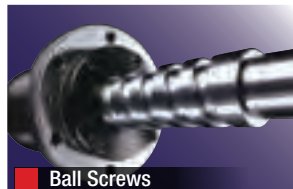

Ball Screws



Cross Roller Rings

### Sales Head Offices

THK Co., Ltd., 3-11-6 Nishi-Gotanda, Shinagawa-ku, Tokyo 141-8503, Japan, Tel: +81-3-5434-0351, [thk@thk.co.jp](mailto:thk@thk.co.jp)

THK GmbH, Hubert-Wollenberg-Str. 13-15, 40878 Ratingen, Germany, Tel: +49 2102 7425 555, [info.ehq@thk.eu](mailto:info.ehq@thk.eu)

THK (Shanghai) Co., Ltd., 1002 Kirin Plaza, 666 Gubei Road, Shanghai 200336, China, Tel: +86-21-6219-3000, [www.thk.com/cn/](http://www.thk.com/cn/)

THK India Private Limited, 2nd Floor, 4/4, 1st Main Road, Industrial Town West of Chord Road, Service Road, Rajajinagar, Bangalore 560044, India, Tel: +91 80 23409934, [thkindia@thkind.com](mailto:thkindia@thkind.com)

THK LM SYSTEM Pte. Ltd., 38 Kaki Bukit Place LM Techno Building, Singapore 416216, Tel: +65-6884-5500, [www.thk.com/sg/](http://www.thk.com/sg/)

THK America, Inc., 200 East Commerce Drive, Schaumburg, IL. 60173, USA., Tel: +1-847-310-1111, [chicago@thk.com](mailto:chicago@thk.com)



## Strong partnership. All you need is yellow.

FANUC offers high-performance CNC systems, unbeatable reliability, and the global support power of dedicated FANUC teams in 210 subsidiaries worldwide. That makes us the partner of choice for the globalized machine tool builder DMG MORI. The most recent result of this partnership: the powerful interplay of DMG MORI's innovative SPRINT 20 | 5 and FANUC's unique 32iB control. **All you need is yellow.**



Powerful combination: DMG MORI SPRINT 20 | 5  
controlled by FANUC 32iB



WWW.FANUC.EU



N° 2 – 2014

— CELOS – From the idea to the finished product  
— An overview of 10 global premières in the second half of 2014

# 10 global premières in the second half of 2014

## MILLING TECHNOLOGY

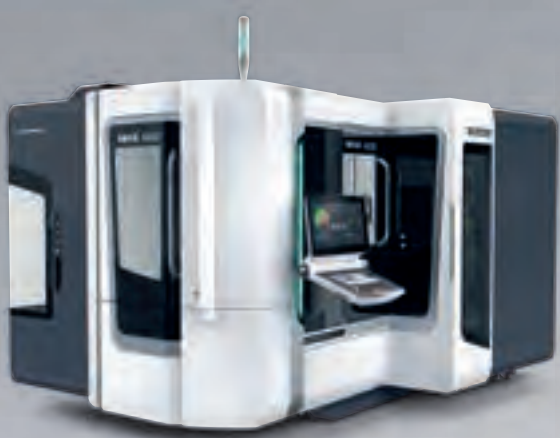

NHX 4000 2<sup>nd</sup> GENERATION

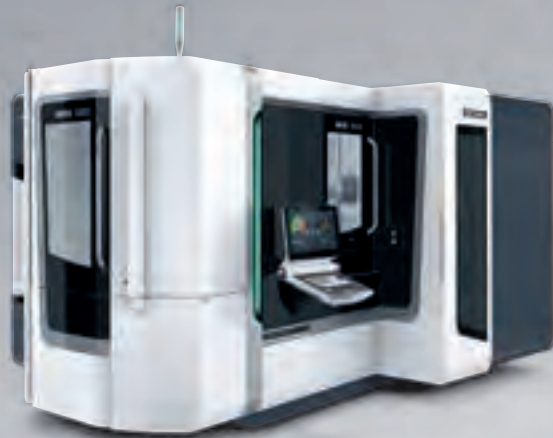

NHX 5000 2<sup>nd</sup> GENERATION



i 50



DMC 1450 V

## TURNING TECHNOLOGY



NTX 1000 2<sup>nd</sup> GENERATION  
Turning & milling technology

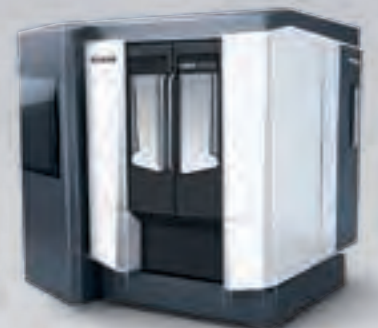

NRX 2000

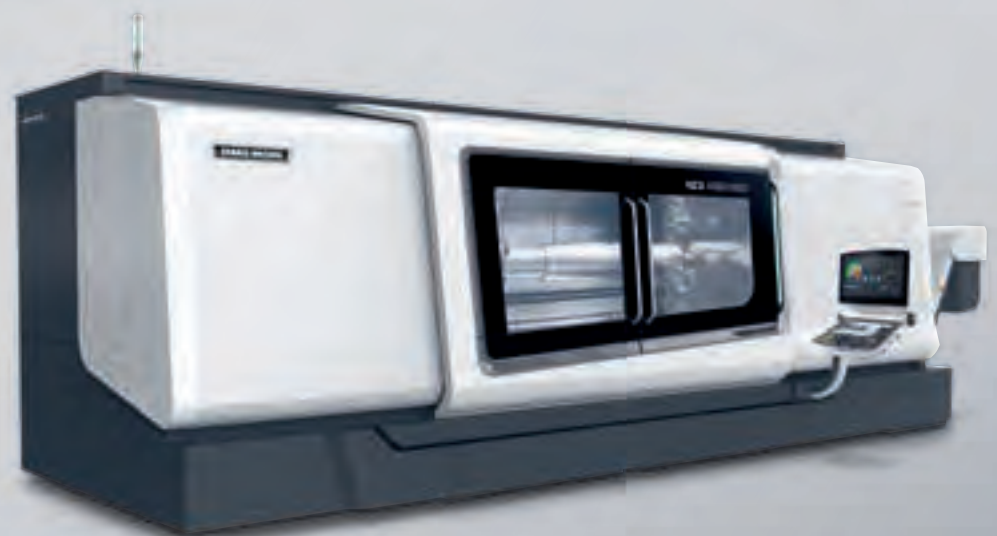

NZX 4000 | 3000

## NEW TECHNOLOGY / LASERTEC



DMU 125 P duoblock® 4<sup>th</sup> GENERATION

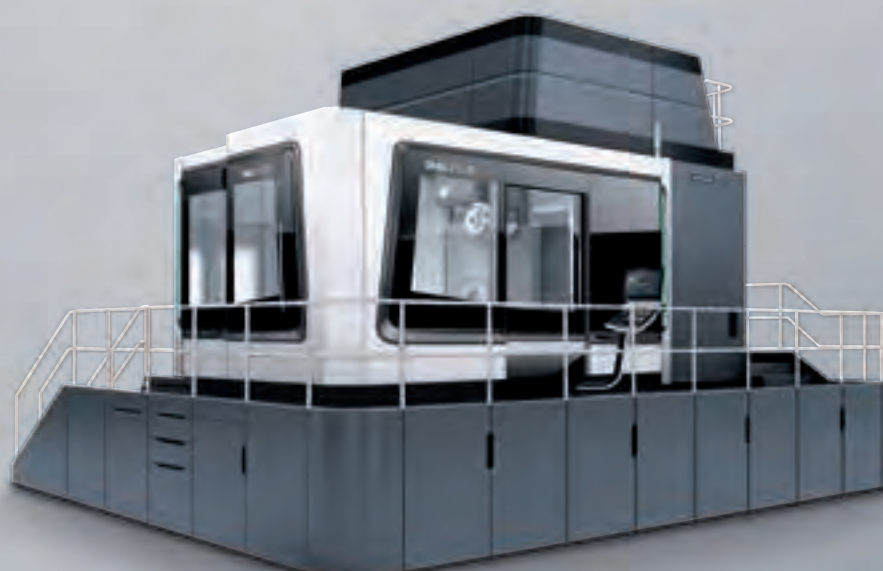

DMU 270 FD  
Milling & turning technology



LASERTEC 45 SHAPE



## CELOS THE REVOLUTION IN MACHINE TOOL CONSTRUCTION

# CELOS from the idea to the finished product.

CELOS from DMG MORI simplifies and speeds up the process from the idea to the finished product. **CELOS APPS** facilitate **consistent management, documentation and visualisation of order, process and machine data** for the user. CELOS combines the workshop and higher-level company structures and creates the basis for fully digital, paperless production. CELOS is **compatible** with PPS and ERP systems, **can be linked to CAD/CAM applications** and is open to future **CELOS APP** extensions.

## MULTI-TOUCH CONTROL PANEL

with CELOS with MAPPS on MITSUBISHI, for innovative convenience of use with a unique range of functions.

## SMARTkey®

Personalised user authorisation:  
Individually adapted access privileges to the control system and the machine.  
With integrated USB storage.



### HIGHLIGHTS OF CELOS

- Simplifies and speeds up the process **from the idea to the finished product**
- Provides a standard **user interface** for all new high-tech machines from DMG MORI
- **30 % less time to the finished product** thanks to **fewer interfaces** between the workshop and higher-level company structures
- **Holistically improves the profitability of production** and the company-wide process chain

**NEW: The PC version of CELOS** allows for the generation and planning of orders on the PC or notebook and can be used as a terminal for any machine.

## Industry 4.0 and CELOS

### The networked value creation system of the future.

After mechanisation, electrification and digitisation of industry, now comes the next step in the development of the industrial revolution – networked, decentralised, real-time capable and self-optimising production and logistics systems. A targeted, skilled reorientation of production facilities will allow companies to take advantage of increasingly streamlined, decentralised and flexible production planning and control in the future.

**CELOS from DMG MORI is a major component of networking at all stages of the production process.**

Using task-specific software applications, CELOS connects the local intelligence on the shop floor with external software solutions for either CAD or CAM and to higher-level company and production systems (ERP / PPS) – eventually making it possible to communicate interactively in global production environments.



**CELOS APPs – 2 examples** » Detailed information and demo versions of all available APPs can be found online: [www.dmgmori.com](http://www.dmgmori.com)



**JOB MANAGER**

Systematic planning, administration and preparation of orders.

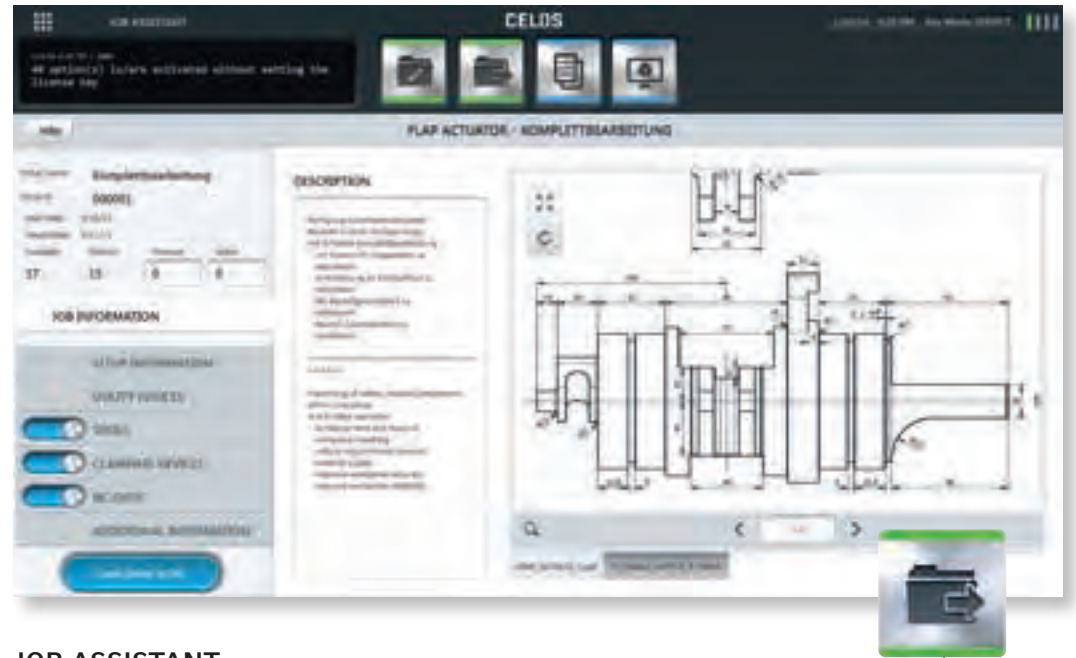

**JOB ASSISTANT**

Define and process orders.

## 21.5" MULTI-TOUCH MONITOR

for quick and easy operation

## APP MENU

Central access to all available applications

## Customer story

*'CELOS is a great step towards paperless production as all data and documents are stored electronically in a complete and structured way. My machines are finally fully integrated into the company organisation and standard workflows are now possible for the employees on all machines. Thanks to the intuitive interface and the boundless ways to connect and create additional APPs, CELOS is the future.'*

**Lothar Horn**  
 Managing Director

Carbide tool factory  
 Paul Horn GmbH  
 Unter dem Holz 33-35  
 D-72072 Tübingen  
[www.phorn.de](http://www.phorn.de)





## NHX HORIZONTAL MACHINING

# NHX 4000, NHX 5000 2<sup>nd</sup> Generation Horizontal machining centres with outstanding rigidity, precision and speed.

With the NHX, DMG MORI is presenting a compact, rapid horizontal machining centre for high-efficiency series production up to mass production in various fields such as the automotive industry and general mechanical engineering. NHX machines come with DDM® technology and linear scales for direct distance

measurement on axes as standard. The use of shorter tools close to the centre of the pallet is also factored into the structure of the machines – this allows higher stability during various machining operations. The new NHX machines are now available in the new unified DMG MORI Design and with CELOS.

Unbeatable cutting performance, speed and accuracy with the new 15,000 rpm speedMASTER.



### HIGHLIGHTS NHX 4000 / NHX 5000 2<sup>nd</sup> GENERATION

- High machine dynamics for up to 2.2 sec. chip to chip time: 1 / 1 / 1g (NHX 4000) / 1 / 1 / 0.8g (NHX 5000); Up to 96 m/min rapid feed, 60 m/min as standard; 35 % higher dynamic rigidity
- Maximum cutting ability with NEW speedMASTER spindle: 15,000 rpm, 111 Nm / 21 kW (40 % ED); 15,000 rpm high torque version up to 200 Nm or 20,000 rpm high speed version optional
- Direct Drive table (DDM®), with up to 100 rpm for shortest positioning time, 0.8 sec. for the NHX 4000, and 1.38 sec. for the NHX 5000
- Perfect chip flow due to steep covers in the working area and robust Y-axis cover of pantograph design
- CELOS with MAPPS on MITSUBISHI for improved usability and machine intelligence

**NHX 4000**  
Unbeatable cutting performance, speed and accuracy

**NHX 5000**  
Very best in market: Highest rigidity with a robust bed, large diameter spindle bearing and powerful table / pallet clamping force

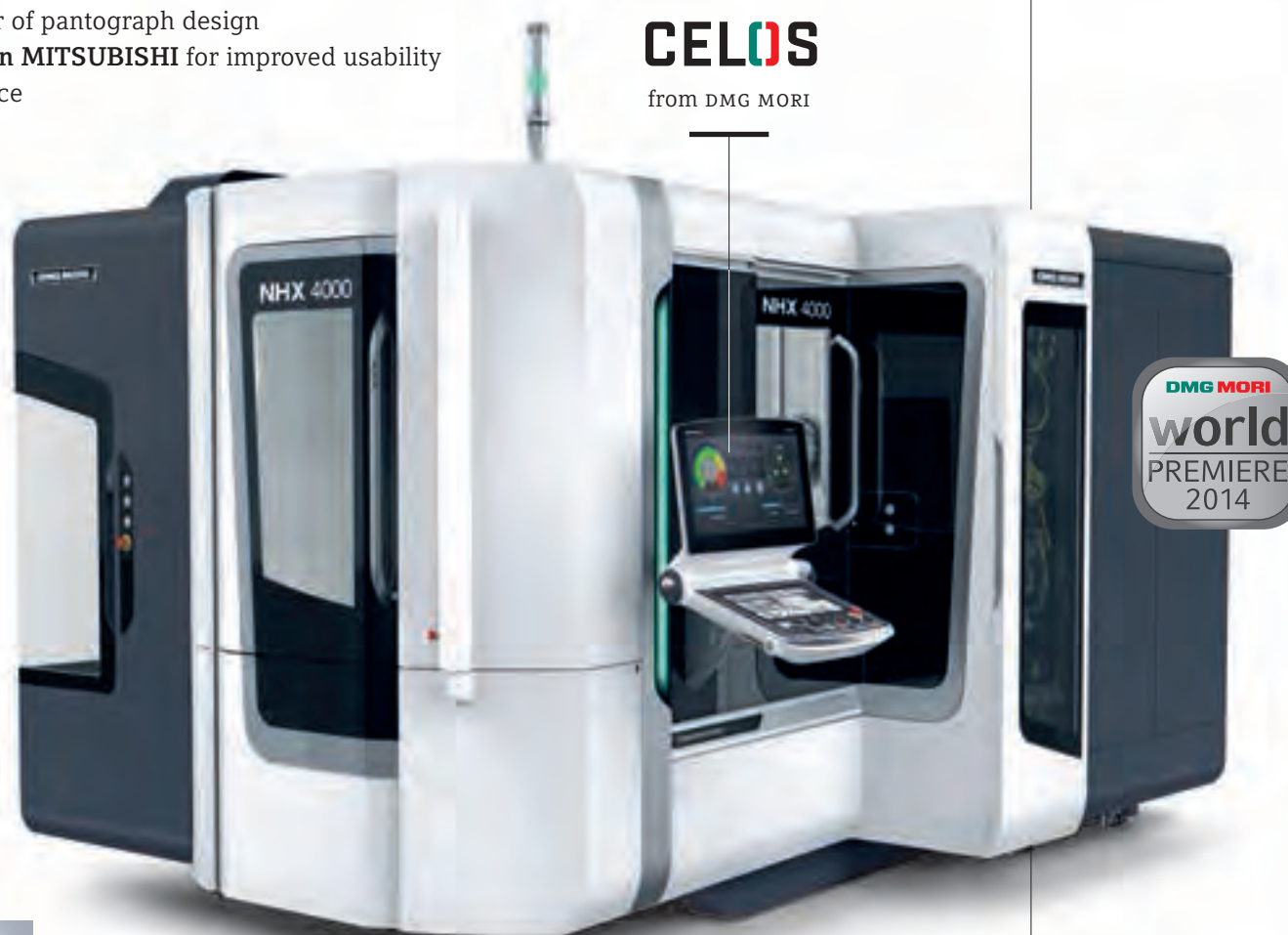

#### TECHNICAL DATA

Travel (X- / Y- / Z-axis): 560 / 560 / 660; maximum workpiece dimensions: ø 630 x 900 mm; maximum table load: 400 kg; pallet size: 400 x 400 mm; tool holder: ISO40

#### TECHNICAL DATA

Travel (X- / Y- / Z-axis): 730 / 730 / 880 mm; maximum workpiece dimensions: ø 800 x 1,000 mm; maximum table load: 500 (700\*) kg; pallet size: 500 x 500 mm; tool holder: ISO40

\* Option



**i-SERIES** HORIZONTAL MACHINING

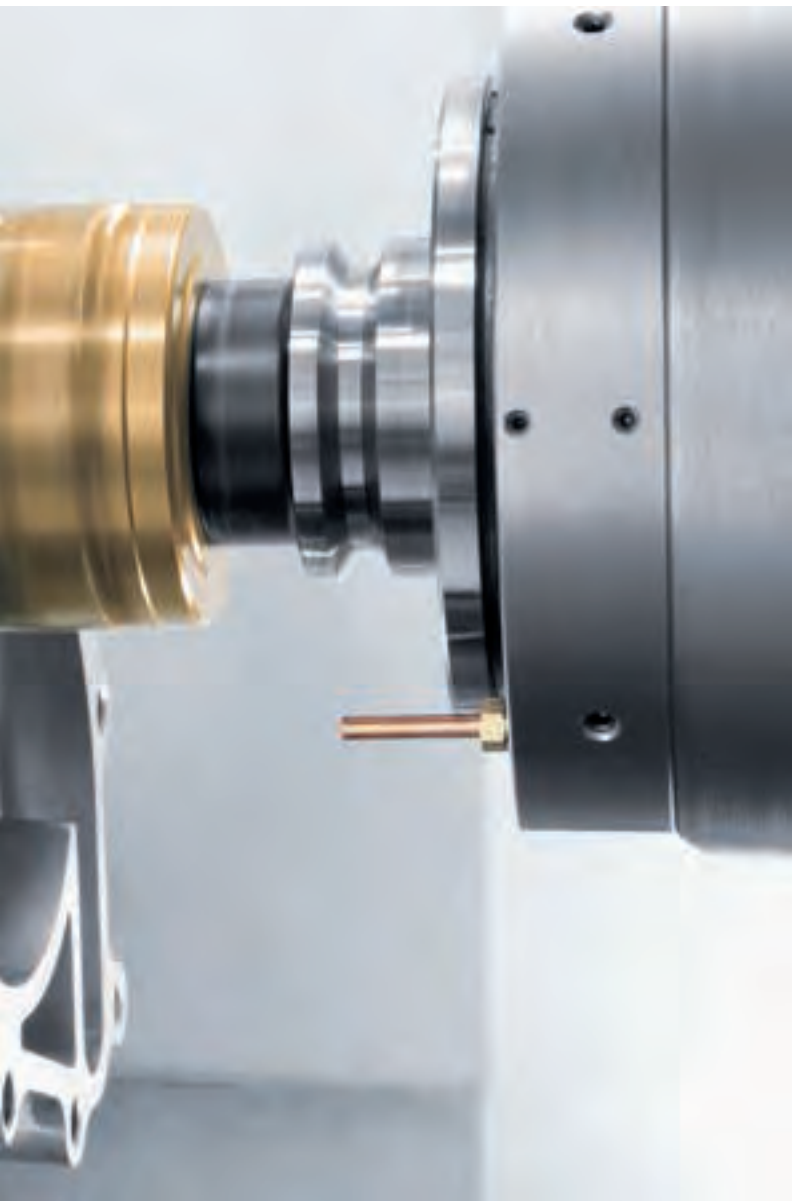

# i 50 – New revolutionary concept for flexible and space saving series production.

More on i 50 automation at DMG MORI Systems

**ON PAGE 42** →



Dual angled guideways for highest rigidity; Guideways isolated from the chip flow.

**NEW speedMASTER spindle**

- \_ 15,000 rpm, 111 Nm / 21 kW (40 % ED)
- \_ 15,000 rpm high torque\*, 200 Nm / 46 kW (40 % ED)
- \_ 20,000 rpm high speed\*, 120 Nm / 35 kW (40 % ED)

\*Option

**CELOS**

from DMG MORI



**Magnescale**

SPEED x PRECISION

from DMG MORI

More on Magnescale

**ON PAGE 31** →

**i 50**  
 High-productivity horizontal machining center

**HIGHLIGHTS DER i 50**

- \_ **Patented (pending) Z-axis kinematic actuation of the spindle:** Dual angled guideways, for highest rigidity; Guideways isolated from the chip flow
- \_ **X / Y / Z travel of the spindle with lightweight moving parts:** High machine dynamics for short chip-to-chip time; Perfect chip flow through machine bed with steep covers
- \_ **All feed drives outside the working area:** No temperature influence for highest accuracy
- \_ **Less machine height** for fast workpiece load
- \_ Table variants with A and B kinematic

**Automotive**



**Workpiece name:** Cylinder block  
**Material:** Aluminum die cast  
**Size:** 350 x 410 x 230 mm  
**Machining time:** 1 min 25 sec

**Automotive**



**Workpiece name:** Cylinder head  
**Material:** Aluminum die cast  
**Size:** 410 x 180 x 120 mm  
**Machining time:** 4 min 59 sec



**TECHNICAL DATA**

Travel (X / Y / Z-axes): 500 / 550 / 500 mm; table working surface: 640 x 500 mm (A-axis specification); 500 x 500 mm (B-axis specification); max. spindle speed: 12,000 rpm  
 rapid traverse rate (X / Y / Z-axes): 62 / 62 / 62 m/min  
 tool storage capacity: 20; Footprint: 6.7m<sup>2</sup>



## DMC V VERTICAL MACHINING

# DMC V range Now complete with four types.

With the **global première** of the **DMC 1450 V**, DMG MORI will present a vertical machining centre on a new scale. Traverses of **1,450 × 700 × 550 mm** and the large, rigid table with **1,700 × 750 mm** workpiece clamping surface and **2,000 kg load capacity** allow a comprehensive range of parts to be machined. Just like the other models in this range, the DMC 1450 V comes with a **14,000 rpm standard spindle rated at 121 Nm torque**, rapid traverses of up to **36 m/min** and a tool magazine with **20 pockets** as standard. The DMC V can be enhanced with options such as an **SK50 spindle rated at 303 Nm** or a tool magazine with **120 pockets**. The **innovative machine concept** and the **cooled drives and guideways** ensure the highest stability and guarantee **maximum precision**.

The large working area allows high-performance machining of workpieces weighing up to **2,000 kg** with the optional SK50 spindle and 303 Nm.



### Innovative cooling concept

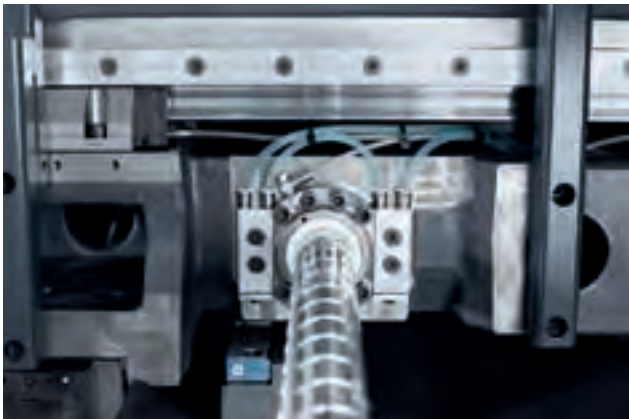

Cooled ball screw nuts and guideways on all three axes (X / Y / Z).

#### HIGHLIGHTS OF THE NEW DMC V RANGE

- **Powerful equipment as standard** – Standard spindle rated at 14.000 rpm / 121 Nm, 36 m/min rapid traverse
- **SK50 spindle rated at 303 Nm** (optional)
- **Tool magazine with up to 120 positions**
- **Workpiece weight up to 2,000 kg**
- **30 % higher precision** thanks to cooled drives and guideways
- **With experience from more than 10,000 vertical machining centres delivered**

The new DMC V range with four types:

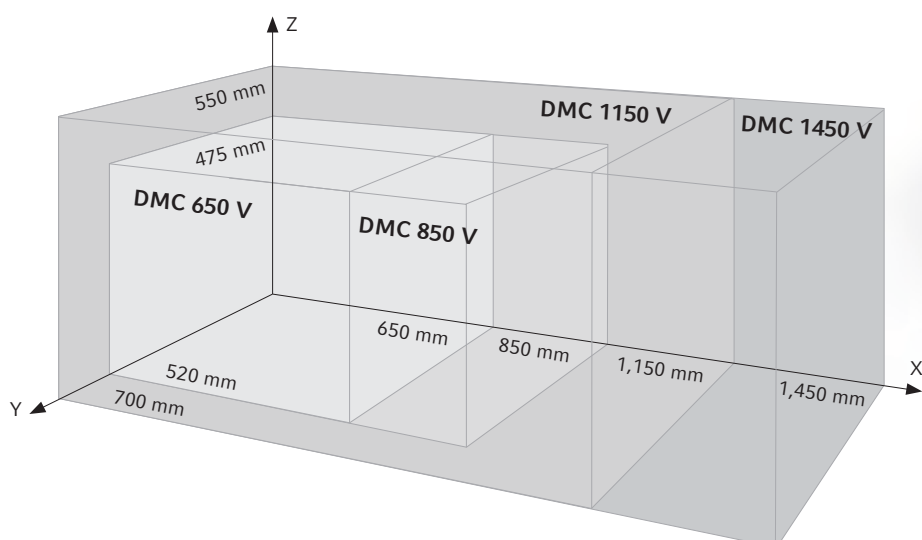

**DMC 650 V**  
The new vertical machining centre with a unique machine concept for more performance and precision

The 'smallest'

**CELOS**  
from DMG MORI



#### TECHNICAL DATA

Travel X / Y / Z: 650 / 520 / 475 mm; Rapid traverse: 36 (42) m/min; Spindle speed: 14.000 rpm; Output: 14.5 kW; Torque: 121 Nm; Table size: 900 × 570 mm; Workpiece weight: 800 kg; Tool magazine: 20 (30 / 60 / 120) pockets





**3<sup>rd</sup> generation DMC V with a new machine concept**

- \_ Stable travelling column design with overhead slideway
- \_ Rigid table for workpieces weighing up to 2,000 kg
- \_ 28 % larger linear guides
- \_ 25 % larger ball screws
- \_ Thermal control: Innovative cooling concept to guarantee precision

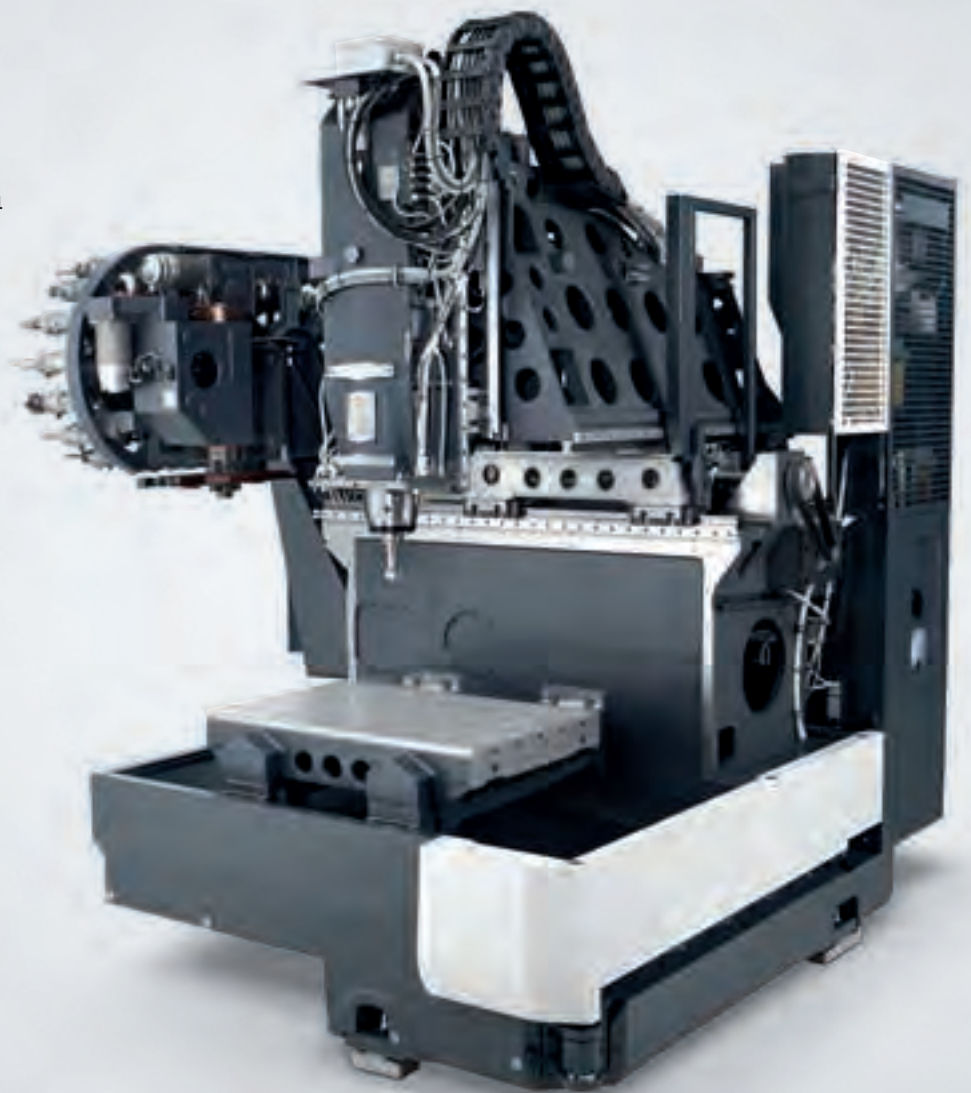

**DMG MORI MICROSET – MEASURING AND TESTING**

**DMC 1450 V**  
 Large working area with 700 mm Y axis for workpieces weighing up to 2,000 kg

The 'largest'



**CELOS**  
 from DMG MORI



**SANDVIK COROMANT**  
 tool kits for milling, drilling and tapping

**TECHNICAL DATA**

Travel X / Y / Z: 1,450 / 700 / 550 mm; Rapid traverse: 36 (42) m/min; Spindle speed: 14,000 rpm; Output: 14.5 kW; Torque: 121 Nm; Table size: 1,700 x 750 mm; Workpiece weight: 2,000 kg; Tool magazine: 20 (30 / 60 / 120) pockets

**UNO**  
 tool pre-setting

**NEW:**  
 Automatic drive for fully automatic tool pre-setting and measurement independent of the operator

- \_ CNC-controlled
- \_ 3-axis tool pre-setting device
- \_ Stepless adjustment
- \_ 24" colour monitor
- \_ SK 50 precision spindle
- \_ Pneumatic spindle brake
- \_ Spindle indexing 4 x 90 degrees
- \_ User-friendly system cabinet

**Options:**

- \_ Second camera
- \_ Thermal label printer
- \_ ISS spindle with power clamping
- \_ Manual RFID system (e.g. Balluff)
- \_ Adapter storage
- \_ Data output by post-processors
- \_ Bidirectional interface for almost all tool management systems



More on  
 DMG MORI Microset

**ON PAGE 48** →



**TECHNICAL DATA**

Measuring range:  
 X = +200 to -50 mm  
 Z = 400 mm



## DMU P 5-AXIS MILLING

# 4<sup>th</sup> generation DMU 125 P duoBLOCK® – 30 % higher component precision thanks to intelligent temperature management.

— The new benchmark in 5-axis machining with **30 % higher precision, performance and efficiency**. The five-axis machines in the highly stable duoBLOCK® design allow the highest machining performance and maximum precision with high dynamics. From hard-to-process materials such as titanium to the highest surface quality standards. The **fourth generation duoBLOCK®** is best suited for processes in sectors ranging from aerospace to tool and mould making. **Comprehensive cooling measures** and the optimised stiffness of the new redesigned duoBLOCK® concept are the basis for the highest possible levels of **precision and machining performance**.

From mould construction to productive parts manufacturing – the new motor spindle rated at 15,000 rpm.

- **Powerful:** HSK-A100, 400 Nm / 52 kW (40 % ED)
- **Reliable:** Spindle growth sensor (SGS) as standard for detecting axial displacement of the rotor compared to the stator. Compensation by the control system
- **Service-friendly:** Quick rotor replacement thanks to the modular design
- Optionally available for the 4th generation duoBLOCK®, portal and DIXI machines



### The highest temperature stability as standard

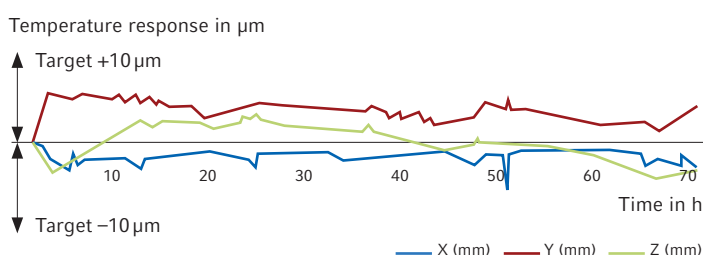

In a 70-hour endurance test, the temperature variation of the basic machine was recorded at between +8  $\mu\text{m}$  and -7  $\mu\text{m}$ .

Example: DMU 80 P duoBLOCK®

### 30 % higher component accuracy with the precision package

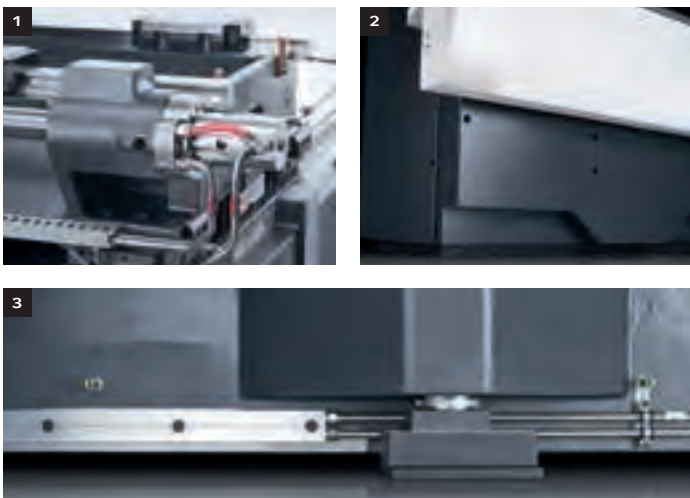

Besides the motors on the B and C axes, gears on the C axis, motor spindle and headstock housing, the fourth generation duoBLOCK® with precision package features the following cooling measures:

#### 1. Full feed drive cooling for the first time:

All drive motors, linear guides, ball screw bearings and nuts on X, Y and Z

#### 2. ThermoShield: Prevents draughts

#### 3. Bed cooling: Cooling bars on the machine bed and column

### DMU 125 P duoBLOCK® Up to 30 % higher component precision

#### HIGHLIGHTS OF THE DMU 125 P duoBLOCK®

- **Performance:** up to 30 % higher stiffness for maximum cutting performance
- **Efficiency:** up to 30 % lower energy consumption with intelligent accumulators
- **The highest flexibility** and shortest machining times with the **new B axis** with 20 % higher stiffness and integrated cable carrier
- Rapid, innovative wheel magazine with a **tool change time of 0.5 second** and up to 453 tools in spite of its minimal space requirements

**CELOS**

from DMG MORI



**Ingersoll performance package** with milling tools for universal applications including face milling, shoulder milling, trimming, chamfering, slotting and circular machining.

#### TECHNICAL DATA

Travel X / Y / Z: 1,250 / 1,250 / 1,000 mm;  
Rapid traverse: 60 / 60 / 60 m/min.; Spindle speed: 12,000 rpm;  
Output: 35 kW; Torque: 130 Nm; Workpiece size:  
 $\varnothing$  1,250 x 1,600 mm; Workpiece weight: 2,500 kg;  
Tool magazine: 40 (63 / 123) pockets



**DMU FD** 5-AXIS MILL-TURNING

Easy access to deep areas with optimised interference contour of the spindle head.

**DMU 270 FD**

Complete machining at the top of the range – high-precision milling and turning of workpieces up to 7 tonnes.

The 5-axis machine in the highly stable portal design generates maximum precision with the highest dynamics. Besides drilling and milling, the turn-mill technology also allows turning in the same clamping. Large traverses of up to 2.7m and high table loads of up to 7 tonnes form the basis of this. The best turn-mill table on the market boasts high levels of stability thanks to its large bearing and is consistently precise thanks to comprehensive cooling measures. The almost wear-free 11,000 Nm and 68 kW DirectDrive technology allows highly precise turning operations and the best possible machining results.

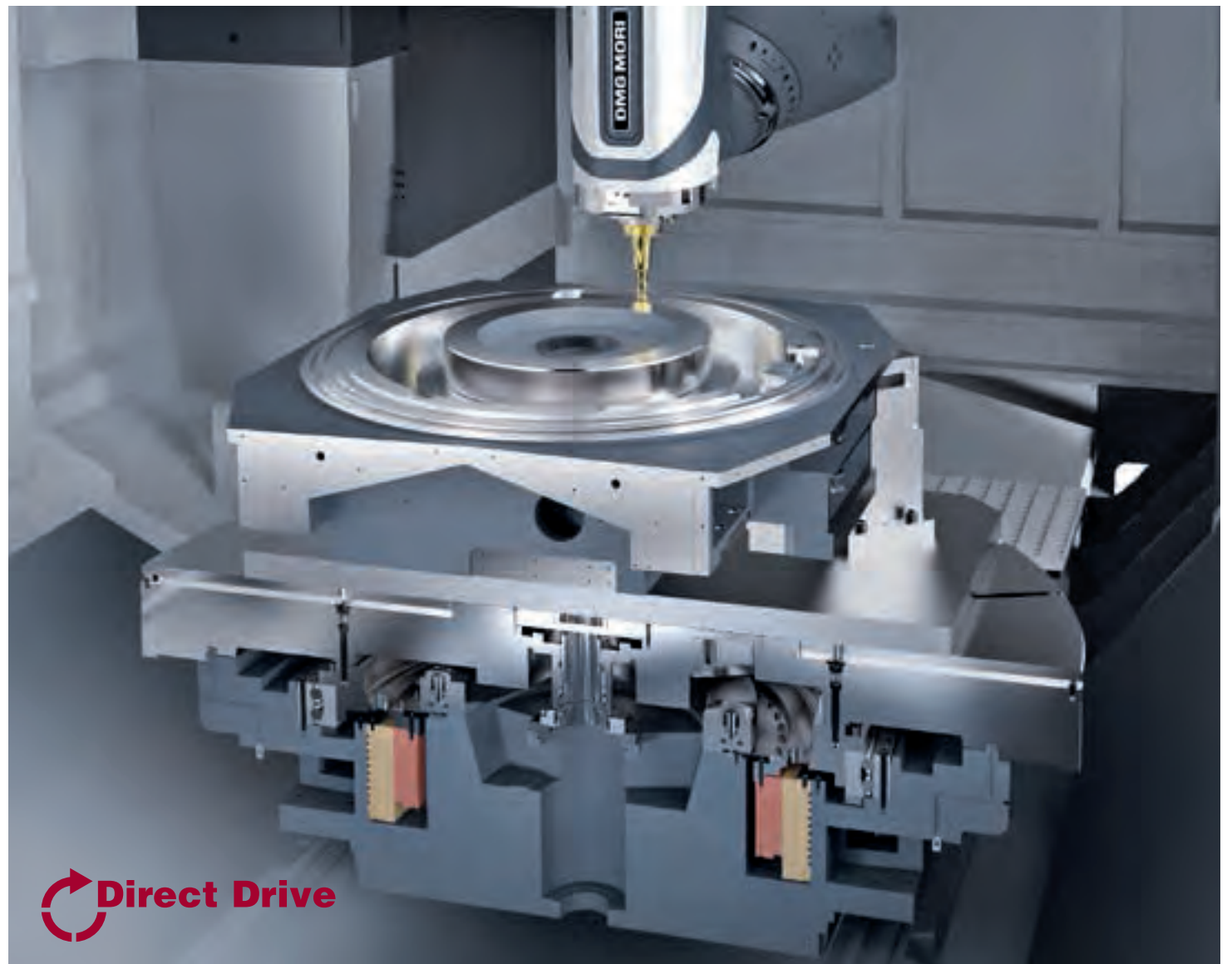

**DMU 270 FD**  
Refined technology from over 15 years' experience in turning and milling

**HIGHLIGHTS OF THE DMU 270 FD**

- \_ Large working area for workpieces up to  $\varnothing 3,000 \times 1,600$  mm and 7,000 kg
- \_ Milling and turning in one clamping with the Direct Drive table rated at up to 200 rpm
- \_ 10 % smaller footprint thanks to the wheel magazine as standard (63 tools)
- \_ B-axis with improved interference contour and internal cable carrier, swivel range of 210°
- \_ High precision thanks to optimised temperature stability
- \_ Three-point support

**CELOS**

from DMG MORI

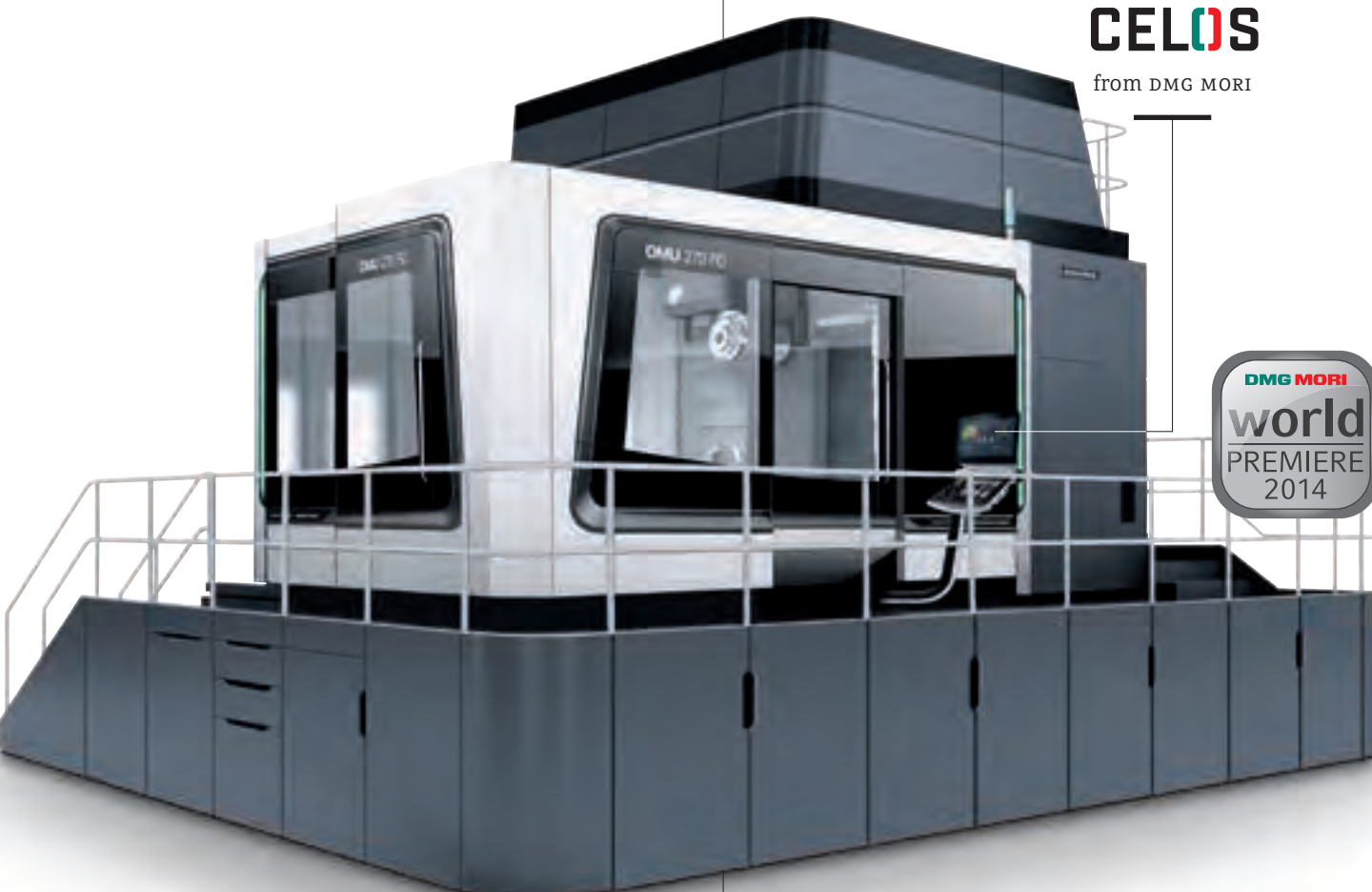
**TECHNICAL DATA**

Travel X / Y / Z: 2,700 / 2,700 / 1,600 mm; Rapid traverse: 60 / 30 / 40 m/min.; Spindle speed: 12,000 rpm; Output: 44 kW; Torque: 288 Nm; Workpiece size:  $\varnothing 3,000 \times 1,600$  mm; Workpiece weight: 7,000 kg; Tool magazine: 63 (123 / 183) pockets

Intelligent software cycles – Up to 80 % faster measurement processes



Laser measuring sensor packages allow for a considerable improvement in reliability and efficiency through the measurement of even hard-to-reach points during the process. Besides the measurement of webs and grooves, even individual points and diameters can be calculated.

powerMASTER 1000 from DMG MORI



- \_ Motor spindle with 77 kW output and 1,000 Nm torque
- \_ Modular design for quick replacement and easy maintenance
- \_ Spindle Growth Sensor (SGS) to compensate for spindle growth
- \_ Optionally available for the 4th generation duoBLOCK®, portal and DIXI machines and for the NHX 6300, NHX 8000, NHX 10000 and NVX 7000





## NTX COMPLETE MACHINING FEATURING TURNING & MILLING

# NTX 1000 – 2<sup>nd</sup> Generation

## High-efficiency integrated mill turn centre equipped with excellent rigidity and volumetric accuracy.

The machines in the NTX range are **compact integrated turn-mill centres** and are suitable for machining in the medical, aviation and aerospace, watch and semiconductor industries. Three of our original technologies facilitate outstanding machining with **high precision and efficiency**. The NTX range is synonymous with high productivity. The 2<sup>nd</sup> Generation NTX 1000 is now available in the new unified DMG MORI Design and with **CELOS**. The **Z-Axis travel** has been extended up to **800 mm** and the Y-axis travel for off-centre machining is 210 mm. Further 5-axis simultaneous machining is possible due to the Direct Drive **B-axis with 240° swivel range**. The optional 10-station lower turret makes synchronous and simultaneous machining possible at the main and counter spindles.



4-axis machining with B-axis and lower turret.



5-axis simultaneous machining with Direct Drive B-axis.

### Medical



Workpiece name: Hip Cup  
Material: Titanium  
Size:  $\varnothing$  60 mm  
Machining time: 7 min 30 sec

### Aerospace



Workpiece name: Blade  
Material: Inconel 600  
Size:  $\varnothing$  40 x 120 mm  
Machining time: Approx. 3 hours

**NTX 1000 – 2<sup>nd</sup> Generation**  
Largest machining area  
for workpieces up  
to 800 mm long and  
 $\varnothing$  430 mm diameter



DMG MORI  
**world**  
PREMIERE  
2014



**CELOS**  
from DMG MORI

#### TECHNICAL DATA

Tool spindle travel (X- / Y- / Z-axis): 455 /  $\pm$ 105 / 800 mm;  
max. turning length: 800 mm; bar work capacity:  $\varnothing$  52 mm ( $\varnothing$  65 mm\*);  
max. tool spindle speed: 12,000 (20,000\*) rpm; tool storage capacity:  
38 tools (76 tools\*); number of tool stations (Turret 2): 10 stations

\* Option





**NLX** UNIVERSAL TURNING

**NLX 1500 | 500  
NLX 2000 | 500 –  
in the new  
DMG MORI Design  
and with CELOS.**

The NLX series offers users maximum performance, flexibility and reliability. Integrated coolant circulation in the machine bed ensures improved thermal stability. The box ways in all axes serve as an optimal base for high performance turning.

Available immediately with MAPPS IV and 10.4" TFT display.\*\*\*\*

\*Available in the new design and with CELOS  
\*\*Only available in the new design and with CELOS  
\*\*\*Currently, NLX 2500|700MC, NLX 2500|1250MC are not available in the new design and with CELOS  
\*\*\*\*19" for the NLX 4000  
Turning = fixed tools, MC = driven tools, Y = driven tools and Y axis, SMC = driven tools and counter spindle, SY = driven tools, Y axis and counter spindle

Machining of complex shapes using multi-spindle tool holders.



**9 machine models with 30 variants.**

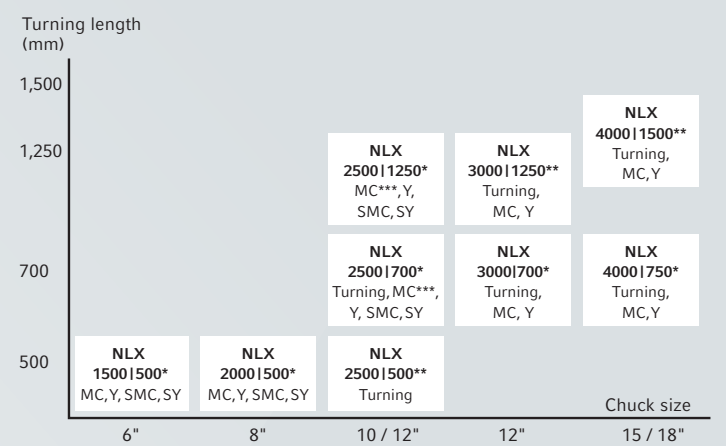

NLX 2500SY|700 produced for the European market in Bergamo.

**HIGHLIGHTS OF THE NTX 1000 –  
2<sup>nd</sup> GENERATION**

- Direct Drive B-axis for 5-axis simultaneous machining of complex-shaped products for medical, aircraft and automotive industries
- Optimised working area with 78 % longer Z-travel for workpieces up to 800 mm long and ø 430 mm: Less workpiece interference due to compact tool spindle and optional lower turret; Up to 10 live tools with up to 10,000 rpm
- Higher production flexibility due to X-axis stroke up to 105 mm under spindle centre
- Highest and constant accuracy without compensation due to thermal control and roller guides for 50 % reduced backlash: Patented (pending) thermally symmetrical headstock cooling system; Cooling of all ball screws and ball screw nuts, turning and milling spindles incl. the B-axis and the BMT-turret; Highly improved straightness, e.g. 2 µm for the Y-axis
- Operate 4.5 on Siemens and from JIMTOF additionally with FANUC 31iB

„Smallest footprint  
in its class at 9.9 m<sup>2</sup>“

**NLX-Series**  
Highly efficient  
universal  
turning machines

*Best-seller!  
The best-selling  
machine from  
DMG MORI*



**CELOS**  
from DMG MORI

**HIGHLIGHTS OF THE NLX 1500 | 500,  
NLX 2000 | 500**

- Box ways are used for all axes
- Coolant circulation inside the castings controls thermal displacement
- With BMT® (Built-in Motor Turret), milling capability is comparable to machining centres
- Y-axis travel: ±50 mm (Y type)
- Digital tailstock as standard equipment improves ease of setup
- Various automation systems including bar feeders and gantry loaders are available
- Spindle 2 max. spindle speed: 6,000 rpm (SMC and SY type)
- New unified premium design

**TECHNICAL DATA**

max. turning diameter: 386 / 366 mm; max. turning length: 515 / 510 mm; bar work capacity: 52 / 65 mm; spindle 1 max. spindle speed: 6,000 (Optional: 8,000) / 5,000 rpm; spindle 1 drive motor: 11 / 15 kW; number of tool stations: 12 (Optional: 10\*, 16, 20)

\*Only available for NLX 2000



**NRX** PRODUCTION TURNING

## NRX 2000

High-speed, front-loading, twin-spindle lathe for mass production lines.

DMG MORI will unveil the NRX 2000, a new two parallel spindle lathe, at JIMTOF 2014 to be held in Tokyo, Japan. The NRX 2000 is ideal for machining flange workpieces, particularly for mass production parts like automotive flanges. Equipped with the world's fastest loader, the NRX 2000 shortens cycle times and achieves maximum productivity in an automated production environment. The machine also employs a single-piece molded internal chip chute to ensure excellent chip disposal, thereby achieving highly reliable, long-term automatic operation. Featuring a compact size, competitive price and outstanding accessibility to the transfer equipment and the inside of the machine, the NRX 2000 provides the best solutions for customers' mass production lines.

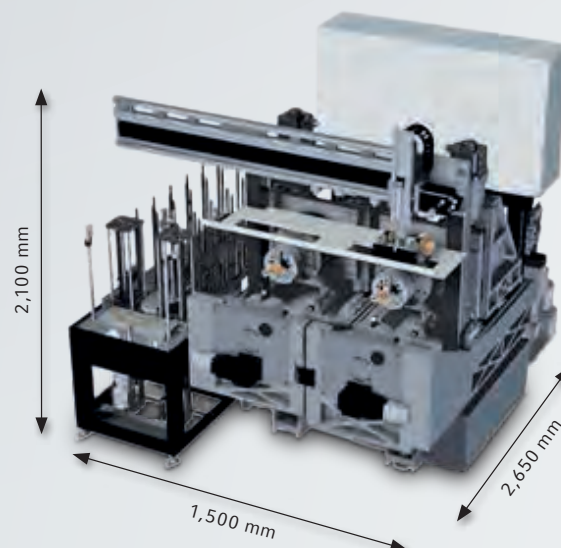

Minimal space requirements, machine width of just 1.5m including automation.

### HIGHLIGHTS OF THE NRX 2000

**NRX 2000 –**  
The world's fastest workpiece loading with 5.8 sec (4.2 sec., collet) loading time

- **Highest productivity due to high-speed workpiece loader:**  
4.2 sec. for unloading and loading by moving the X-axis and gantry loader, 5.8 sec. for chuck parts; Machining continues at one spindle during loading of the other
- **Most suitable for mass production machining of flange-shaped parts for automobiles:**  
**40,000 parts per month;** Perfect for workpieces up to  $\varnothing$  120 mm and 80 mm long, up to  $\varnothing$  160 mm and 100 mm long optional
- **Drastically improved chip removal capacity:**  
Movement in X and Z of the workpiece (spindle) and fixed tool turret for perfect chip fall
- **Control: COMPACTline with MAPPS**

#### Automotive



Workpiece name: Gear  
Material: SCM420H  
Size:  $\varnothing$  80 x 40 mm  
Machining time: 80 sec.

#### Automotive



Workpiece name: Shaft stator  
Material: SCr420H  
Size:  $\varnothing$  100 x 70 mm  
Machining time: 120 sec.

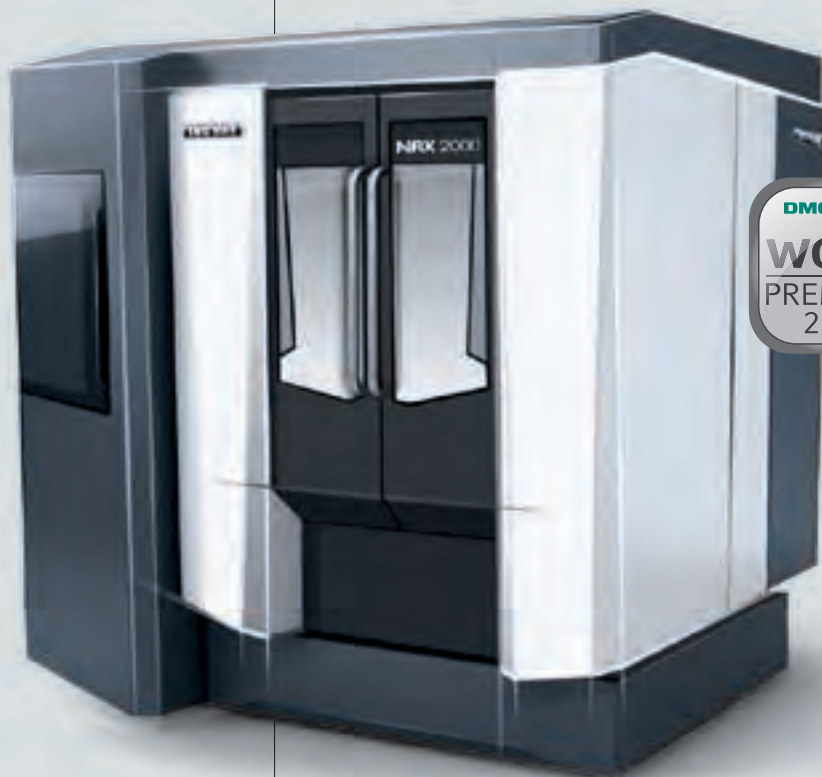

#### TECHNICAL DATA

Travel (X- / Z-axis): 120 / 200 mm; Rapid traverse rate (X- / Z-axis): 30 / 30 m/min; Max. spindle speed: 5,000 rpm; Chuck size: 8";  
Max. loading workpiece size:  $\varnothing$  160 x 100 mm; Loading time: 5.8 sec.

**NRX** PRODUCTION TURNING

## NZX 4000 | 3000

High-efficiency shaft machining with 2 turrets.

Long and large diameter workpieces like oil well pipes indispensable for the oil and energy industries. The NZX 4000 has two turrets and demonstrates a high level of machining capability in the **heavy-duty cutting** of long, large-diameter workpieces by capitalising on the high rigidity and bar work capacity and utilising the **BMT® (Built-in Motor Turret)** technology that provides milling capability rivalling that of a **No. 40 taper** machining centre. With a wide variation of through-spindle holes available, making it possible to handle many types of workpieces, this is **the ultimate large-scale 4-axis turning centre**, capable of achieving high productivity.





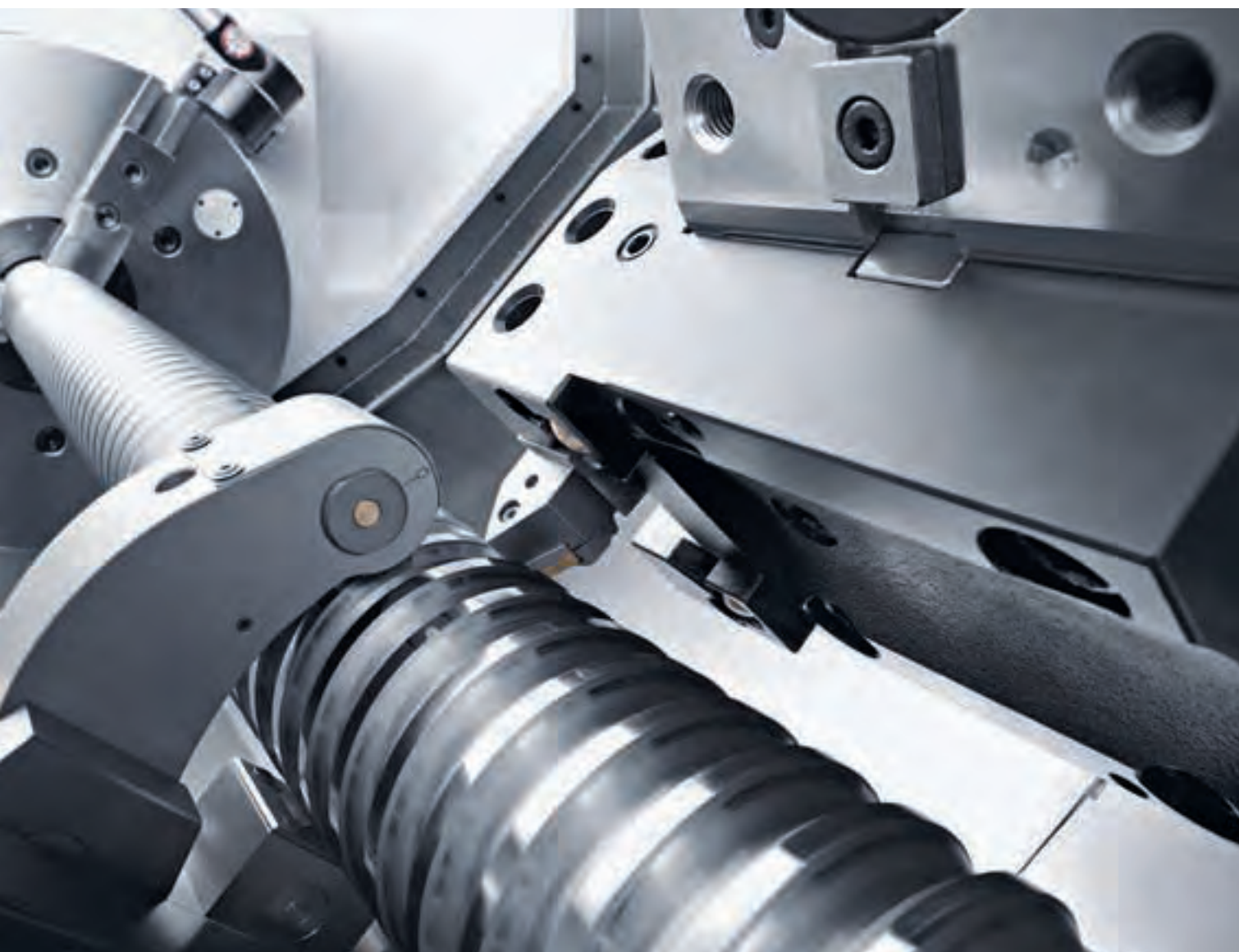

The NZX 4000|3000 is capable of high efficiency heavy-duty machining of workpieces up to  $\varnothing$  660 mm x 3,000 mm.

Big Bore Spindle bore up to  $\varnothing$  285 mm.

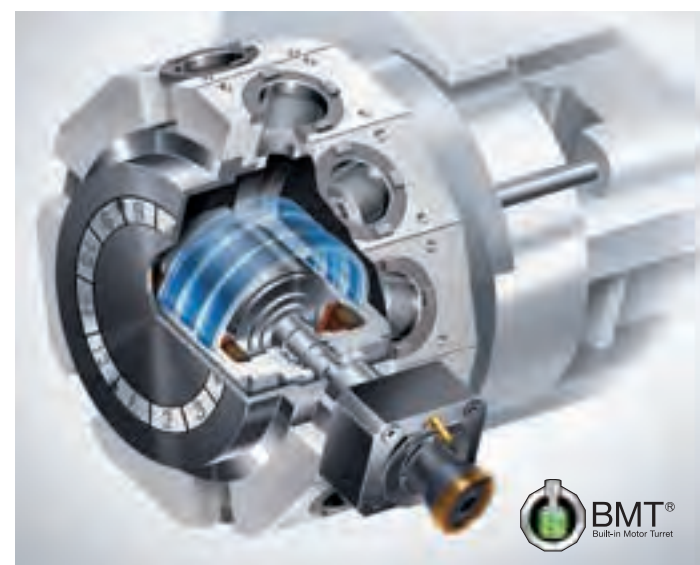

Built-In Motor Turret with up to 117 Nm torque.

**HIGHLIGHTS OF THE NZX 4000 | 3000**

**NZX 4000 | 3000 –**  
 Large-scale high-efficiency  
 4-axis turning centre  
 that achieves the ultimate in  
 productivity with long and  
 large diameter workpieces

- \_ **Highly rigid, stable heavy-duty machining** achieved with wide box ways
  - \_ **Multi-axis machining** for large-diameter shafts with Turret 1 Y-axis + Milling, Number of tool stations: 12 (Turret 1) + 8 (Turret 2)
  - \_ Turret 1 **milling ability comparable to that of a No. 40 taper machining centre**: 11 / 7.5 kW Built-in Motor Turret
  - \_ 3 variations of through-spindle holes:  
 $\varnothing$  145 /  $\varnothing$  185 /  $\varnothing$  285 mm (A / B / C)
  - \_ The **long boring bar** allows long, I.D. boring\*
  - \_ Up to two NC steady rests can be installed\*
- \* Option

**CELOS**  
 from DMG MORI

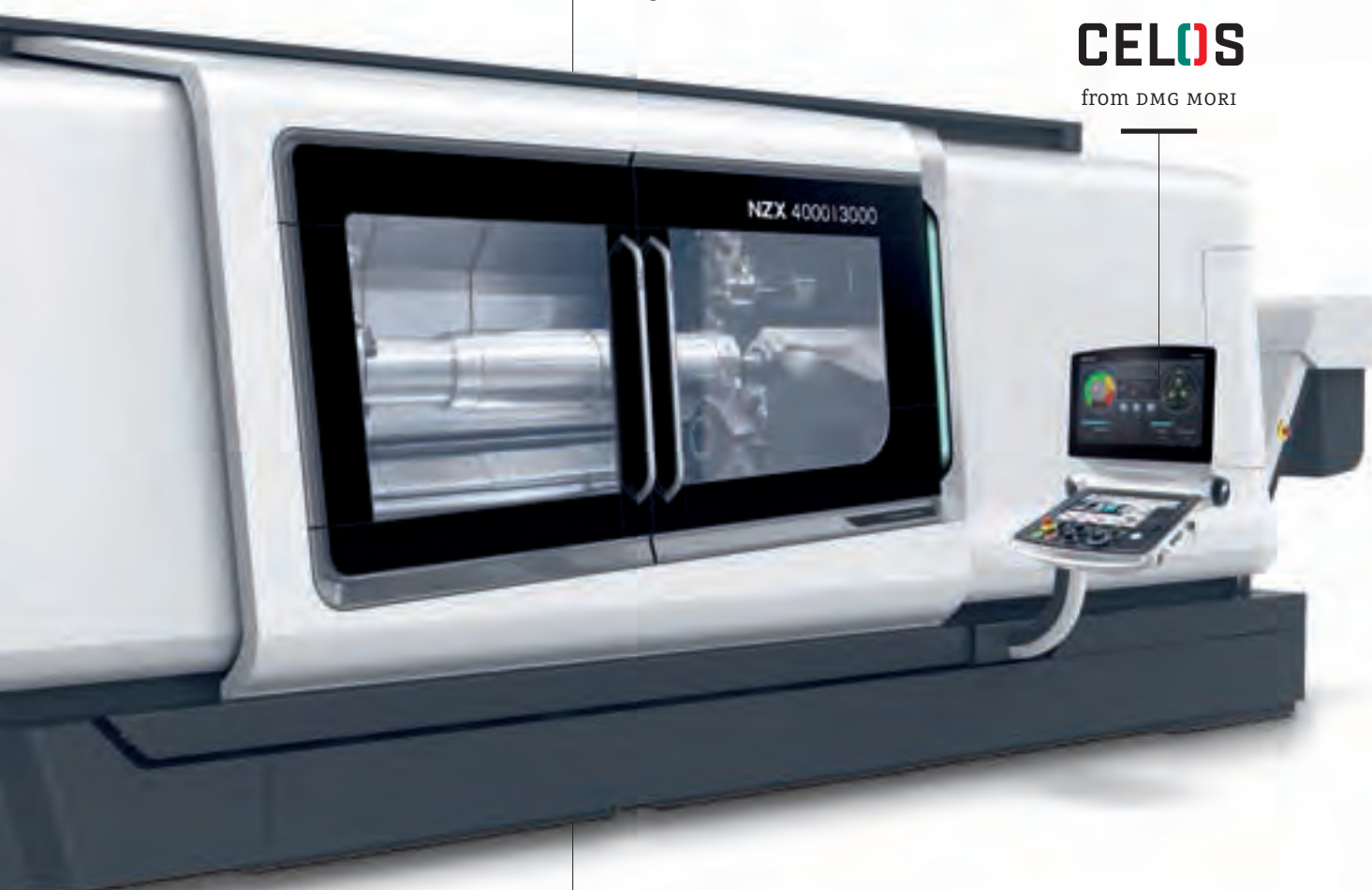

**TECHNICAL DATA**  
 Max. turning diameter:  $\varnothing$  660 mm; max. turning length: 3,000 mm; number of turrets: 2 (Y-axis available for Turret 1 only); max. spindle speed: 2,000 / 1,500 / 1,000 rpm (A / B / C); chuck size: 15~24"; max. rotary tool spindle speed: 3,500 rpm

**Spindle**

We have prepared a wide variety of through-spindle holes suitable for various long / large-diameter workpieces. The spindle offers high output while keeping its size small by using a belt-less, gear driven design:

- A-type: 2,000 rpm, max. 6,700 Nm and 45 kW
- B-type: 1,500 rpm, max. 7,020 Nm or 75 kW
- C-type: 1,000 rpm, max. 12,070 Nm or 75 kW

**BMT® (Built-In Motor Turret)**

The built-in structure, in which the motor is placed inside the turret, minimises heat generation and vibration, improves transmission efficiency and significantly increases cutting power, speed and accuracy.

**Effects of the BMT®**

- > Improved milling power with 117 Nm and 11 kW
- > Improved milling accuracy
- > Controls the turret's heat and vibration
- > Reduced energy loss

**Magnescale**

SPEED X PRECISION

from DMG MORI

The highest precision with a direct distance measurement system from Magnescale with a resolution of 0.01  $\mu$ m as standard

More on Magnescale

**ON PAGE 31** →



**LASERTEC** 

## LASERTEC 45 Shape

### High-precision 3D laser removal and texturing – a new dimension.



Working area of the LASERTEC 45 with integrated swivelling / rotary table (5-axis version), laser head with precision scanner, CCD camera and retractable measuring sensor.

#### HIGHLIGHTS OF THE LASERTEC 45 SHAPE

**LASERTEC 45 Shape**  
5-axis laser precision machining up to  $\varnothing$  300 mm in a footprint of under 4 m<sup>2</sup>\*



Laser ablation: Intricate cavities in miniature

- \_ 80 % larger working area with the same space requirements plus 3 times higher dynamics with 60 m/min rapid traverse (compared to the LASERTEC 40)
- \_ 5-axis laser machining made possible by the integrated swivelling / rotary axis with torque motors (optional)
- \_ Siemens 840D sl with 15" touch screen: Programming directly at the control panel

\* Layout of the machine with no accumulators



#### TECHNICAL DATA

Travel X / Y / Z: 700 / 420 / 485 mm; Maximum acceleration X / Y / Z: 10 / 10 / 18 m/s<sup>2</sup>; Swivel range (A axis): -100° to +120°; Maximum workpiece weight (3-axis / 5-axis): 400 / 100 kg; Maximum workpiece size:  $\varnothing$  300 x 200 mm; Control system: SIEMENS 840D solutionline with 15" touch screen

## DMG MORI HIGH-TECH COMPONENTS

### Milling spindle – speedMASTER

**NEW: speedMASTER from DMG MORI – #40 universal milling spindle with 10,000-hour guarantee\***

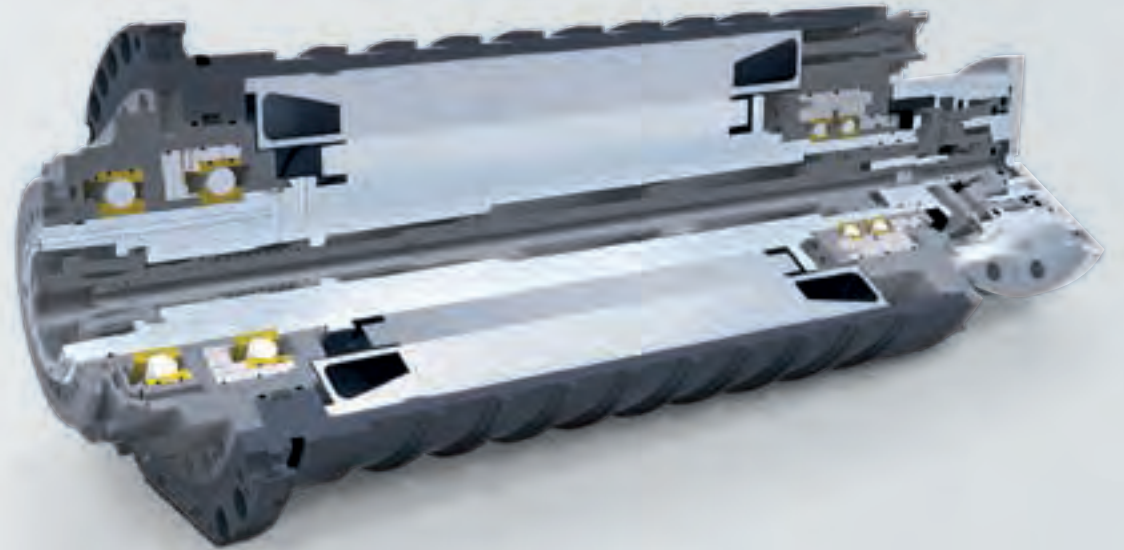

**Maximum cutting performance** in the basic configuration as standard

- \_ 15,000 rpm, 111 Nm and 21 kW (40% ED)

Optional

- \_ **High torque:** 15,000 rpm, 200 Nm and 46 kW (40% ED)
- \_ **High speed:** 20,000 rpm, 120 Nm and 35 kW (40% ED)

\* Guarantee: 10,000 hours or 18 months.

**Maximum service life and precision**

- \_ Large spindle bearing for a long service life
- \_ Optimised sealing, no ingress of coolant
- \_ Durable tool holding for the highest repeatability

**As standard** for the 2nd generation of the NHX range; available from 2015 for monoBLOCK®, NVX, DMC V and DMU.

More spindles from DMG MORI:  
**powerMASTER, torqueMASTER, compactMASTER®**

### Tool magazine

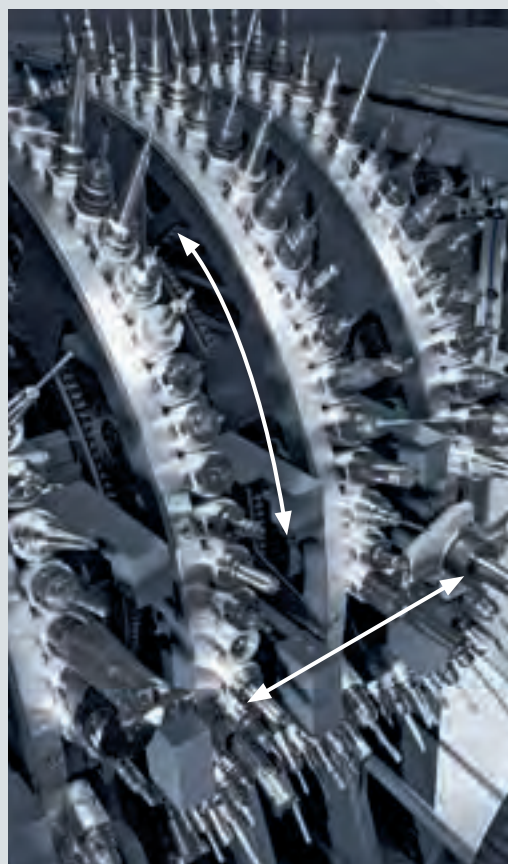

#### Intelligent wheel magazine – patented technology

- \_ Set-up during machining and idle time (from two wheels)
- \_ The most compact magazine on the market (41 % lower machine width with 123 stations)
- \_ Up to 453 tool stations, maximum deployment time of 5.6 seconds
- \_ Extremely short tool change time of just 0.5 seconds (0.8 seconds for HSK-A100)
- \_ Safe retention thanks to the holder
- \_ No disassembly to transport up to 123 (SK 50) / 183 (SK 40) tools

**As standard** for the 4th generation duoBLOCK®, DMU 270 P/FD and the DMC H linear range.



## Turret

### BMT® built-in motor turret – turret with integrated drive motor

Similar cutting performance to a milling machine

- Up to 12,000 rpm or up to 200 Nm torque

The BMT® effect

- Improved milling performance and precision thanks to integration of the motor inside the turret for optimal transmission
- Reduced turret heat and vibration levels, thermal displacement of  $< 0.5 \mu\text{m}$

Available for the NL, NLX, NZX, NT, NTX and DuraTurn ranges.



## B axis

### New B axis – improved interference contour, higher stiffness

- 20 % higher stiffness thanks to the large YRT bearing, further improvement of the already stable B axis concept with  $45^\circ$  swivel plane
- Integrated cable carrier – improved interference contour, higher quality thanks to better sealed housing, longer life thanks to mechanically guided cables

As standard for the fourth generation duoBLOCK® and the DMU 270 P/FD.

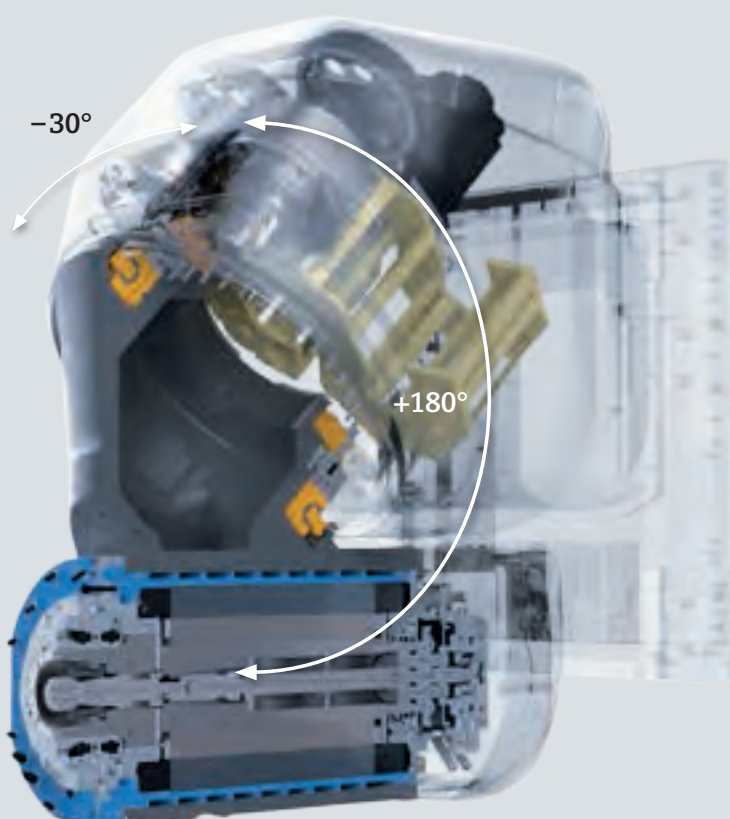

## LASERTEC 65 3D

### Additive manufacturing – Laser additive manufacturing and integrated milling.

The additive manufacturing video:

[www.3D.dmgmori.com](http://www.3D.dmgmori.com)

If your mobile phone has QR code recognition software, you will get straight to the video.

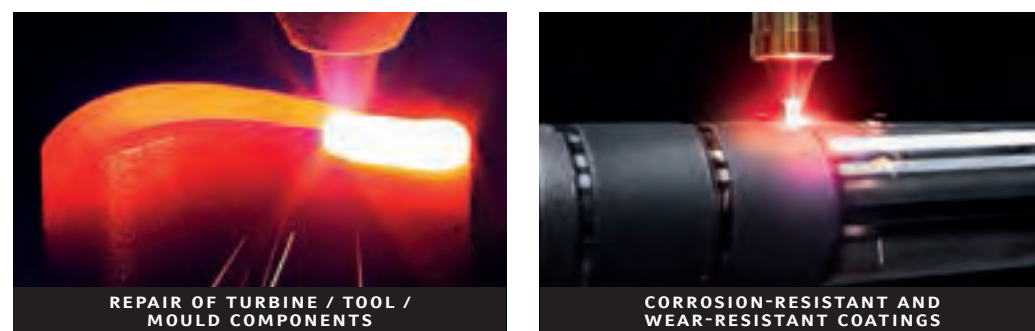

Target market segments: Tool/mould making, aerospace, automotive, medical, off-shore, mechanical engineering

#### HIGHLIGHTS OF THE LASERTEC 65 3D

**LASERTEC 65 3D**  
Additive manufacturing of 3D components in finished parts quality



Laser additive manufacturing and milling of turbine blades

- The intelligent combination of laser deposition and milling allows the **best surface finishes** and component precision to be achieved
- Laser deposition with powder feed: up to **10 times faster** than the powder bed method
- **Feasibility of complete 3D components** measuring up to  $\varnothing 500$  mm, even with steep contours and no supporting geometry
- **Direct machining of areas** that can not be reached on the finished part



**CELOS**  
from DMG MORI

#### TECHNICAL DATA

Travel X / Y / Z: 650 / 650 / 560 mm; Maximum workpiece dimensions (5-axis):  $\varnothing 500 \times 350$  mm; Maximum load (5-axis): 600 kg; Footprint (machine only): approx. 12 m<sup>2</sup>; Control system: CELOS from DMG MORI with 21.5" ERGOline® Control with Operate 4.5 on SIEMENS 840D solutionline



*J. Lehmann*  
Jens Lehmann,  
Brand ambassador of SCHUNK

**German Champion**  
with Borussia Dortmund 2002

**English Champion**  
with Arsenal London 2004

**Used in more than 10,000 lathes worldwide**

ROTA-S plus 2.0, manual chuck from SCHUNK

Dominic Schneider,  
Master Lathe Chuck Technology

**German Meistermacher.**

Higher productivity in your machining processes with SCHUNK Champion products.

**up to 2,000 Nm**  
Torque at Ø 32 mm  
SCHUNK TENDO E compact  
Hydraulic expansion toolholder

**1.200** standard chuck jaws  
The world's largest  
chuck jaw program for  
every chuck type

**60** seconds jaw change  
SCHUNK ROTA-S plus 2.0 lathe chuck

Held more than 10,000 times under high pressure

Jens Lehmann, German goalkeeper legend

www.gb.schunk.com/rota-s-plus

**SCHUNK** Superior Clamping and Gripping



## REDEX - The Machine Tool Drive Company

Hi-tech reducers for rack & pinion machine axes and milling spindles.

Leader in machine tool gearboxes and racks, REDEX has developed a product range with optimized stiffness, high accuracy and a modular design, which are all essential features for modern and dynamic machine tool.

The patented design using unique integral pinion with high-capacity taper roller bearings allows the highest "stiffness to the rack" on the market.

Through its worldwide sales network, with 7 subsidiaries and 2 research centers, REDEX provides full support for product sizing, integration and commissioning.

**REDEX**  
The Machine Tool Drives Company

ANDANTEK UK - Rowley Drive - Coventry CV3 4LS  
T. +44 24 7630 7722 | F. +44 24 7630 4499 | sales@andantex.co.uk | www.machine-tool-drives.com



# KESSLER

## Highest precision from components to service.

With over 90 years of expertise as a partner of the machine tool industry KESSLER assists its customers with a comprehensive range of high-tech spindles and spindle systems, for example the 1000 Nm spindle, high speed motor spindles with integrated regreasing – including motors and assemblies such as rotary / tilt-rotary tables and spindle swivel heads for 5-axis machining that is both efficient and precise.

We provide detailed process and fault analysis for each repaired spindle. As well as, providing replacement spindles and spare part deliveries as required. In any case you will benefit from fast reaction times, fast delivery times and maximum quality standards with regard to products and services.

Kessler Portfolio

High-tech spindles

- Externally driven spindles  
Milling  
Drilling  
Turning
- Direct driven spindles  
Milling  
Drilling  
Turning  
Grinding  
Special solutions



Motor Technology

Motors

- Asynchronous motors  
air-cooled, water-cooled
- Synchronous motors  
air-cooled, water-cooled
- Torque motors  
Internal rotor, external rotor

Motor kits

- Rotary current asynchronous
- Rotary current synchronous



System Engineering

Spindle heads

- 1-axis spindle heads
- 2-axis spindle heads
- Special solutions

Tables/Component axis

- 1-axis
- 2-axis
- Multi-axial



Service Solutions

- Individual service-packages  
Basic  
Comfort  
Premium
- Spare Part Management  
with maximum availability
- Field Service  
quickly and efficiently on site
- Academy  
Know-how for your employees



www.franz-kessler.com



N° 2 – 2014

- DMG MORI – the exclusive premium partner of the LMP1-team
- Linear motor technology: maximum precision and productivity
- New centre of excellence for production turning machines
- Innovative technologies for tool and mould making
- ECOLINE – HIGHEST FUNCTIONALITY, BEST PRICE

# Technologies and customer stories

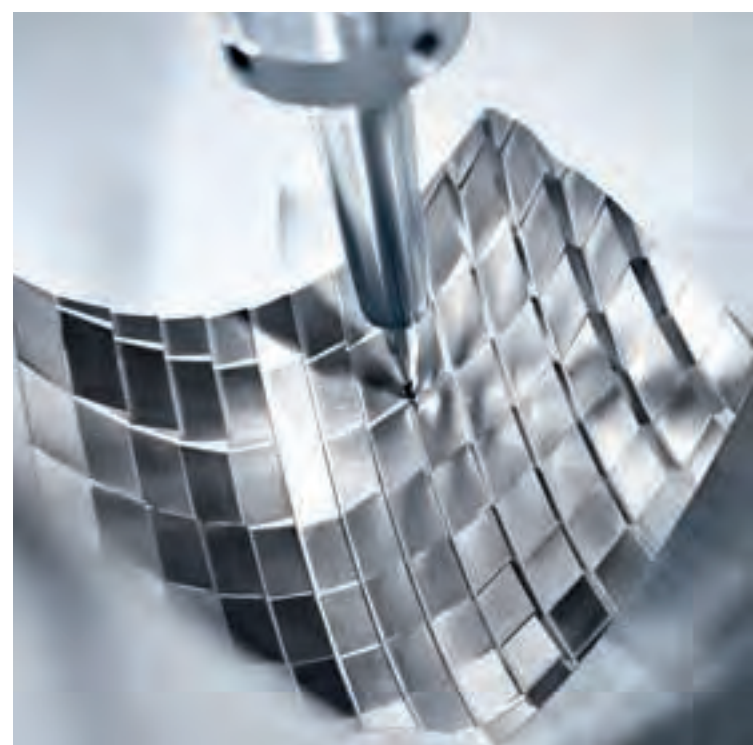



# CHOPARD

## Superfast Chrono Porsche 919 Edition.

Chopard is a watch and jewellery factory founded by Louis-Ulysse Chopard in 1860 and now based in Geneva. Since 1996 the company has operated a watch factory in Fleurier where it makes fine watches and in-house watches, and since 2008 it has run an industrial manufacturer of basic mechanical components called Fleurier Ebauches. A DMU 60 monoBLOCK® from DMG MORI is one of the machines used there.



The Fleurier Ebauches workshops: High-precision manufacturing on the next generation of machines.

Together with DMG MORI, Chopard will support the LMP1 Porsche motorsport team on its long-awaited return to the WEC. To mark the occasion, as the Official Timing Partner of Porsche, Chopard will introduce a strictly limited-edition Porsche 919 watch. This is based on the design of the Superfast Chrono watches and features details from the Porsche 919 Hybrid. Stamped with the 919 logo at 9 o'clock, the silver colour is reminiscent of the prestigious Porsche colour. The black and red touches perfectly match the Porsche 919 Hybrid.

### Limited edition 919 watches

CHF 11,450.-

EXCLUDING VAT

The extraordinary COSC certified men's watch is limited to 919 units.

DMG MORI has an exclusive number of watches available for its customers. When you order from DMG MORI, the price of the watch will be charged by Chopard directly and the watch will be shipped from Switzerland free of charge.

Send orders to:  
laura.keller@dmgmori.com

**REFERENCE NUMBER:**

168535-3002

**FUNCTION(S):**

Chronograph, flyback function

**DISPLAY(S):**

Hours and minutes, seconds, date, chronograph second hand, 30-minute timer, 12-hour timer

Available in late 2014

[www.chopard.com](http://www.chopard.com)



DMG MORI & PORSCHE

DMG MORI & Porsche – tradition, precision and technological leadership with a global presence.

With the 919 Hybrid, in 2014 Porsche will return to the LMP1 class of the FIA World Endurance Championship (WEC) after 16 years. DMG MORI is the exclusive premium partner of the Porsche team as it returns to the top class of the auto racing world championship. The WEC consists of 8 races on 3 continents with the 24 Hours of Le Mans race as the highlight of the season. DMG MORI has a tradition in the automotive industry and in racing. Porsche is returning to the long-distance races in order to reclaim its original image as a sports car manufacturer with the best technology. DMG MORI is supporting this, especially as a technology partner to the vehicle supplier. The new partnership between DMG MORI and Porsche will bring their shared values of tradition, precision and technological leadership with a global presence to the fore once again and prove that DMG MORI is a reliable partner.

*'I have always had a passion for Porsche. That's why it's a great honour for me to be part of the Porsche LMP1 team at the top level of motorsport!'*

Mark Webber



**DMG MORI**





Global première of the Porsche 919 Hybrid in Geneva in March 2014 (from left to right): Dr Masahiko Mori (President of DMG MORI SEIKI CO., LTD), Matthias Müller (CEO of PORSCHE AG) and Dr Rüdiger Kapitza (CEO of DMG MORI SEIKI AG)



# 919 HYBRID

## MAXIMUM EFFICIENCY FOR THE FUTURE OF CARS.



Le Mans 2014 – the breakthrough into a new, more technologically driven age of motorsport.

— The Porsche 919 Hybrid is an energy-saving concept of a (super) sports car made possible by hybrid technology. The new **efficiency based rules of the WEC** require cutting-edge **hybrid technologies**. Technologies that will restore the status to prototype racing that endurance racing has always had: subjecting the technology of tomorrow to the **most stringent tests in motorsport** today. Racing cars have never been so technologically complex. The LMP1 cars may not exceed a predefined level of energy consumption per lap – and they have to use a hybrid drive train. The rest is up to the engineers! The issue of **energy efficiency and saving** plays a central role at DMG MORI and features in the Porsche prototypes. Dr Kapitza explains: ‘Porsche has

crammed lots of **innovative ideas** into this car and in doing so it has taken on the most difficult issues – this is exactly how we believe one can **successfully overcome the challenges of the future.**’

The WEC races are not just a matter of driving a couple of fast laps. They are a matter of perseverance – a **strenuous effort for human, machine and components**. Besides energy efficiency, for DMG MORI the **development of innovative materials and components** is a main motive for this cooperation. The WEC rules and Porsche challenge DMG MORI in many fields. With strict rules on **efficiency, safety and sustainability**. In brief: rules on **future viability**.



In his first race in the Porsche 919 Hybrid, Mark Webber reached the podium beside Timo Bernhard and Brendon Hartley and was excited by the good start to the season and the speed of the 919 Hybrid.

### Porsche 919 Hybrid

The 919 Hybrid follows the tradition of the winner of Le Mans, the 917, but with a nod to the 918 Spyder it also marks the beginning of a future featuring hybrid technology.

**917:** First overall winner of Le Mans from Porsche.

**918:** Fastest road car on the Nordschleife of the Nürburgring.

**919:** The return to the top class of the world sports car championship.

The 919 Hybrid features a recovery system on the front axle which stores the energy from braking. It also features a second system which uses the excess pressure from the exhaust system to generate energy. This makes the 919 Hybrid the only racing car to recover energy during acceleration.



## LINEAR DRIVES AVAILABLE IN 46 MACHINES FROM 12 RANGES

### CTX *linear* – Turning with 1 g acceleration thanks to the linear drive with a 5-year guarantee.

‘The future is *linear*’ has been the motto at DMG MORI for 15 years now. The linear drives convert the resulting **machine dynamics and precision**, as well as the improved durability compared to conventional feed drives, directly into customer value. Additionally: With the linear drives in combination with digital control systems, **high standard quality with a high KV factor** can be achieved. This minimises lag and allows **excellent positioning accuracy** even during high travel speeds. Besides **high rates of acceleration**, backlash and elasticity have been eliminated from the drive train so that linear motors have an **excellent level of static and dynamic stiffness**. Thanks to the contact-free transmission of power, direct linear drives are also **wear-free**. DMG MORI offers a **5-year guarantee on the linear drive**.

#### HIGHLIGHTS OF THE LINEAR DRIVE

- The shortest non-productive times thanks to rapid jerk and 1 g acceleration: **Rapid positioning** even on short travel distances – **ideal for grooves and recesses**
- **Maximum stiffness = maximum long-term accuracy** and surface finish: Consistent positioning thanks to the elimination of elasticity in the drive train – **ideal for hard turning**
- **Low maintenance, minimal life cycle costs**: No mechanical transmission elements, **no wear and a 5-year guarantee** – **ideal for use in production**

### 15 years of linear drive technology

Over 15,000 linear motors used successfully since 1999, **46 machines** from 12 ranges available with a linear drive.

Turning technology	Milling technology	New technology
CTX beta <i>linear</i>	DMC H <i>linear</i>	ULTRASONIC <i>linear</i>
CTX gamma <i>linear</i>	DMU eVo <i>linear</i>	LASERTEC <i>linear</i>
CTX beta TC <i>linear</i>	DMF <i>linear</i>	
CTX gamma TC <i>linear</i>	HSC <i>linear</i>	
CTV <i>linear</i>		
SPRINT <i>linear</i>		

‘With the linear drive I can work 30 % faster with maximum long-term accuracy.’

**linear** **DRIVE**

5-year guarantee

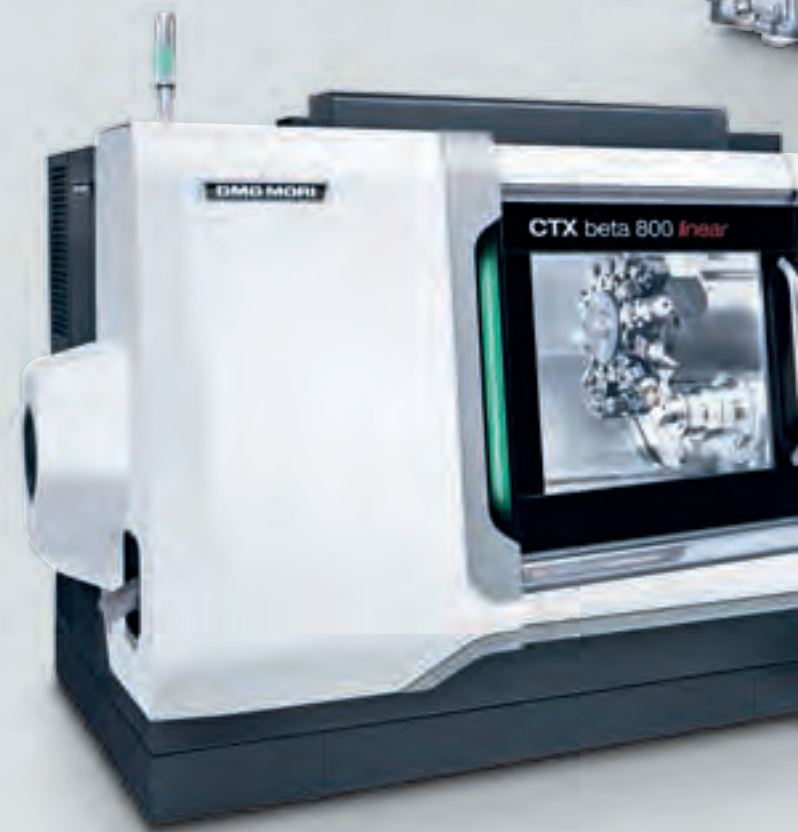

### DMU eVo *linear*

### Customer story

### DMF *linear*



With the DMU eVo *linear* machining centres, Amdale is able to meet the ever-stricter precision requirements in the aerospace industry and in motorsport.



In 2013 Martin Koerner (left), Managing Director of Amdale, added a DMU 60 eVo *linear* and a DMU 80 eVo *linear* to his company's machine outfit.

### AMDALE LTD. – Three times the accuracy thanks to linear drives for Vettel & Co.

For subcontractors such as Amdale Limited, based in Portsmouth, UK, proximity to customers and markets has always been the overriding priority. So it's no wonder that the company has continuously expanded its range of services since it was established in 1988, and that it now wants to conquer the lucrative yet **demanding aerospace market**. This sector is expected to make up 30 % of the company's

turnover in the future – reason enough to invest in **highly precise high-tech machines from DMG MORI**. However, last year the high precision requirements in the production of **engine parts for the new Formula 1 1.6-litre V6 engines**, which were introduced in 2014, gave Managing Director Martin Koerner every reason to acquire a new **DMU 60 eVo *linear*** and the larger **DMU 80 eVo *linear***. The results speak for themselves: **The machines work within the tight tolerances** expected of drive components in the motorsport industry.

‘Whereas in the past we had to adhere to a degree of precision between two datums of  $\pm 25 \mu\text{m}$  for a Formula 1 component, nowadays we are expected to achieve **three times the precision** between three datums’, explains Koerner. The linear drives of the DMU eVo range also make their contribution in this regard.

### UKB – Uwe Krumm Burbach GmbH – dynamic machining with a 6,000 mm linear drive in the X axis.

Over its 23 years in business, Uwe Krumm Burbach GmbH has become a **leading European partner** in the development and production of **complex press brake tooling**. Its holistic range of services includes a CNC milling workshop which has relied on **DMF column milling machines** from DMG MORI since 2006. The company's founder Uwe Krumm is highly satisfied: ‘The machines are **robust, precise and, thanks to the linear drives, very dynamic**.’ This is based on a total of eight models which all work with an extremely high degree of reliability: one **DMF 360 *linear***, four **DMF 220 *linear***, one **DMF 500 *linear*** and two **DMF 180**. This made it easy for him to invest in a ninth model from the range in 2014. ‘With the **DMF 600|11 *linear*** and its **6,000 mm traverse** in the X axis, we are now able to machine even larger workpieces’, explains Uwe Krumm. This is also advantageous to him in his more recent venture of pure CNC contract machining.



Contact: AMDALE LTD., Units 6 & 7 Culverin Square, Limberline Road, Portsmouth, Hampshire, PO3 5BU  
sales@amdale.co.uk, www.amdale.co.uk





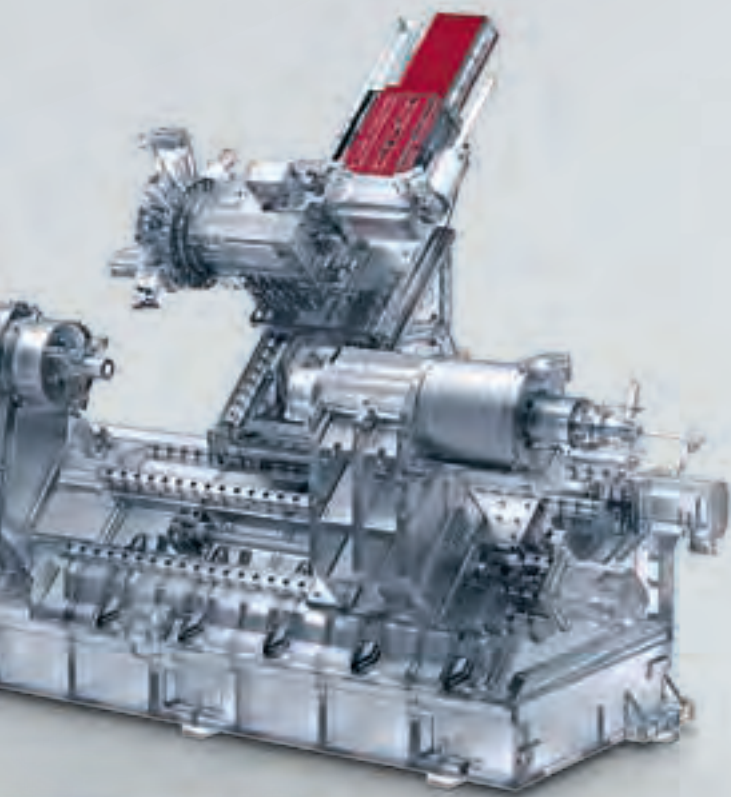

**CELOS**  
from DMG MORI

**CTX beta 800 linear**  
Linear drive on the X axis with 1 g acceleration and maximum long-term accuracy.

## Customer story



Uwe Krümm (right): 'The DMF 600 | 11 linear stands out thanks to its dynamics and long-term accuracy'.



Even fully extended – up to 1,100 mm in the Y axis – the milling head with B axis machines without vibrations.

Contact: UKB – Uwe Krümm Burbach GmbH  
Carl-Benz-Str. 49, 57299 Burbach, Germany  
Tel.: +49 (0) 2736 / 4442 – 0  
post@ukb-gmbh.de, www.ukb-gmbh.de



## CTX TC TURN-MILL COMPLETE MACHINING

**CTX beta 800 TC –**  
Turn-mill complete machining  
with the new compactMASTER®  
turn-mill spindle.

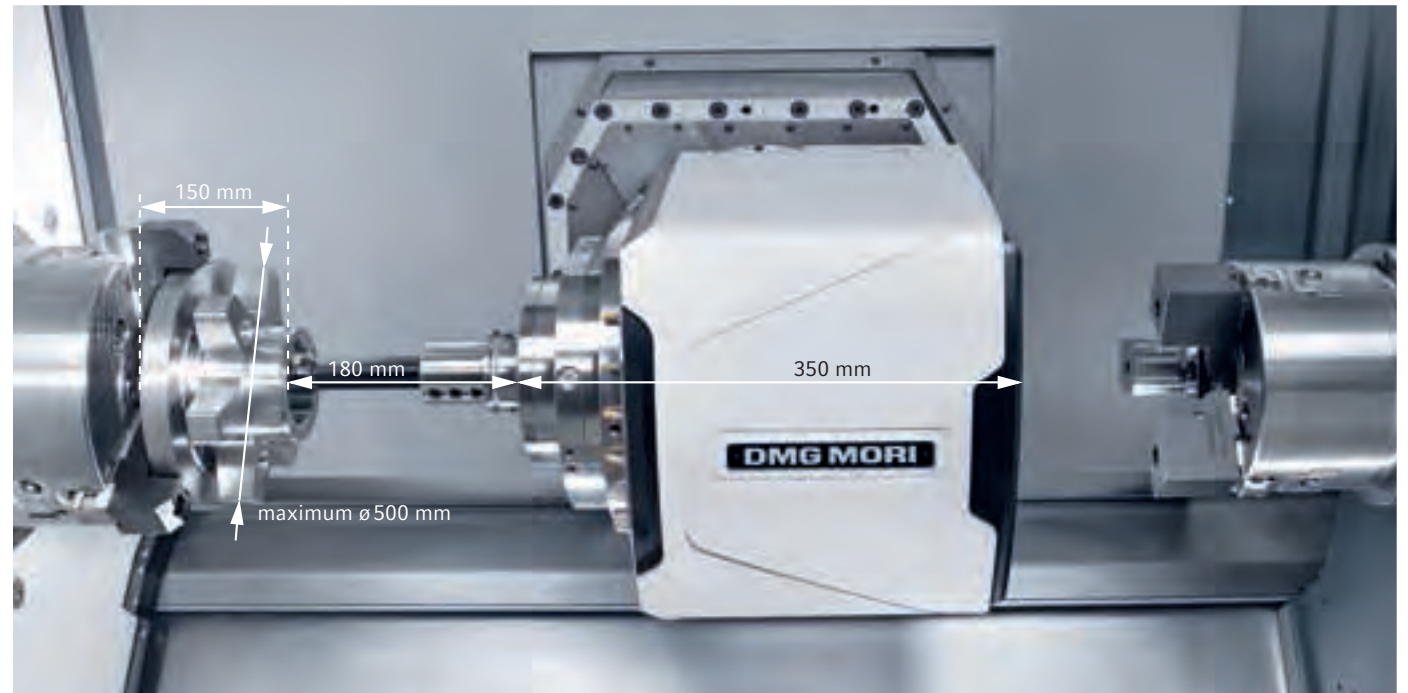

Workpieces measuring up to  $\varnothing$  500 mm and with a turning length of 800 mm can be machined by the ultra-compact turn-mill spindle. Steadies\* with a diameter of up to 200 mm and chucks\* measuring up to 400 mm can be used (\* optional).

### HIGHLIGHTS OF THE CTX beta 800 TC

- compactMASTER®: Ultra-compact turn-mill spindle for minimal space requirements in the working area and **20 % higher torque**: HSK-A63
- **170 mm more space** with the new B axis:  
**Bore or hollow turn 150 mm long workpieces horizontally**
- Workpieces measuring up to  $\varnothing$  500 mm and with a turning length of **800 mm** in a footprint of **8.5 m<sup>2</sup>**
- **6-sided complete machining** with the main and optional counter spindle
- Eccentric machining **with the 200 mm Y-axis travel**
- HORN / LMT / SCHUNK tool package for turning, milling and drilling



**CELOS**  
from DMG MORI

### TECHNICAL DATA

Maximum turning length: 800 mm; Maximum workpiece diameter: 500 mm; Y-axis travel:  $\pm$ 100 mm; ISM 76 main spindle rated at 5,000 rpm, 380 Nm, 34 kW; HSK-A63 turn-mill spindle rated at 12,000 rpm, 120 Nm, 22 kW; disc-type tool magazine with 24 stations, optional chain magazine with up to 80 stations



## PRODUCTION TURNING

# GILDEMEISTER Italiana – The DMG MORI centre of excellence for production turning machines.

GILDEMEISTER Italiana S.p.A. in the Italian commune of Brembate di Sopra in Bergamo is the centre of excellence in the DMG MORI group when it comes to manufacturing lathes for economically machining rotationally symmetrical components in larger batch sizes ranging up to mass production. Over 45 years of experience in turning is reflected in more than 4,500 multi-spindle turning machines installed around the world, as well as 4,000 automatic turning machines. Production turning machines with up to three turrets and single-spindle turning machines for turning short and long parts are as much a part of its range of services as top class cam-type and CNC-controlled multi-spindle turning machines. The location also manufactures the NLX 2500SY|700 for the European market in the new DMG MORI design including CELOS with MAPPS on MITSUBISHI.

Investment of over € 15 million in the DMG MORI centre of excellence for production turning machines.

- › New cutting-edge assembly hall with an area of over 1,200m<sup>2</sup> for machines in the SPRINT range, the multi-spindle turning machines GM and GMC, as well as the NLX 2500SY|700
- › New technology centre for the development of customer-specific solutions and demonstrations
- › 50 application technicians for technology, time studies and support
- › 25 % higher productivity and 20 % lower space requirements for the new mechanical production area thanks to the use of cutting-edge and automated machines
- › Climate control to ±1° C of the area for the production of high-precision components such as machine beds for multi-spindle turning machines

The fully modernised premises of Gildemeister Italiana S.p.A. in the Italian commune of Brembate di Sopra in Bergamo resulting from a € 15 million investment.



The new technology centre with an area of 1,000 m<sup>2</sup> for the development of customer-specific solutions and demonstrations.

## SPRINT 20|5 Turning of short and long workpieces measuring up to ø 20 × 600 mm

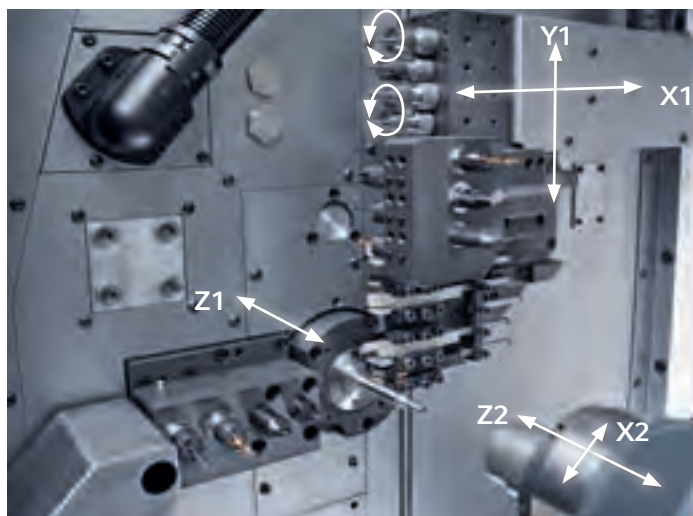

Working area with space for 23 tools on 2 independent linear carriages, including 4 driven tool stations for the main spindle and 2 optional driven tool stations for the counter spindle.

### Short component turning



Medical / dental implant  
Material: Titanium alloy  
Size: ø 6 × 11 mm  
Machining time: 160 sec

### Long component turning with SWISSTYPEkit



Automotive / injector  
Material: AISI 303  
Size: ø 12.2 × 34.5 mm  
Machining time: 95 sec

**SPRINT 20|5**  
For machining  
workpieces measuring  
up to ø 20 × 600 mm  
in a footprint  
of under 2 m<sup>2</sup>

### HIGHLIGHTS OF THE SPRINT 20|5

- \_ SWISSTYPEkit\* for short and long part turning on one machine, with a changeover time of under 30 minutes
  - \_ 23 tool stations on 2 independent linear carriages
  - \_ Up to 6 driven tools, 4 stations as standard
  - \_ 20 % shorter tool change times with the quick tool-change system\*
  - \_ Long workpieces measuring up to 600 mm are discharged through the counter spindle\*
  - \_ MITSUBISHI M70 or FANUC 32i-B CNC control system with 10.4" colour display
- \*Optional



*'An outstanding  
ratio of machining  
area to space  
requirements'*

Footprint  
of under 2 m<sup>2</sup>



## LARGE MACHINES

### XXL centre – The most cutting-edge large machine pro- duction facility in the world!

#### Excellent conditions

Large machines of the highest quality, stability and precision have been **made in Pfronten** with the DMU 340 P and delivered around the world for over a decade now. With its new XXL centre, DECKEL MAHO is now reaching another milestone by **doubling the production capacity** of the DMU 600 P portal machines. Two foundations and the high specification building and craneage provide the **perfect conditions** from the assembly of the XXL machines up to their acceptance by the customer. With a degree of accuracy of  $\pm 1^\circ \text{C}$ , the fully air-conditioned environment allows maximum mechanical precision even on this scale.

The new XXL centre will double the production capacity of the DMU 600 P machines.

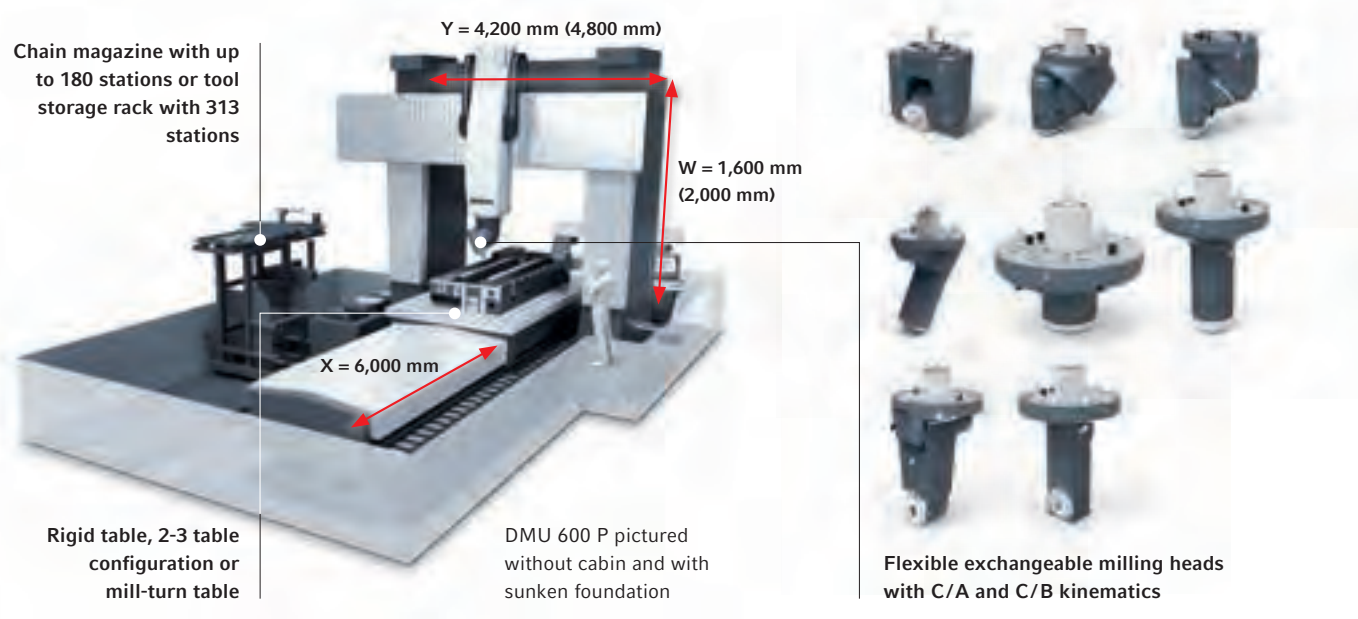

## DMU 600 P

## Customer story



Thanks to the DMU 600 P, the machining process for the grooves on the surface of this cable drum was reduced from 1–2 days to just 3 hours.



'We are excited by the results of our cooperation with DMG MORI.'  
Urs Morgenthaler, Managing Director of BUNORM AG.

### BUNORM AG – DMU 600 P: XXL machining of work- pieces up to 18 metres long and 75 tonnes in weight

For the Swiss machine builder BUNORM, complexity has no limits. Be it a single part or a complete system – BUNORM AG has grown to face every challenge of **large parts manufacturing** and its ever-expanding customer base values the precision, punctuality and innovative spirit of this company with 65 employees. With its comprehensive range of machines, Bunorm now specialises in large machine

components and its latest investment, a DMU 600 P from DMG MORI, ticks every one of these boxes. Within a **total length of 41 metres**, workpieces measuring up to **18 m x 3 m x 3.5 m** and weighing up to **75 tonnes** can be **fully and simultaneously machined with five axes** on three tables. 'Smaller' parts up to 6 metres in length can be machined separately on each of the three tables. 'The **machining of workpieces up to 18 metres in length on three tables** and the ability to set up smaller parts **during machining** make the DMU 600 P something special – not to mention a deciding factor for ensuring our family company's success in the future', says Managing Director Urs Morgenthaler. And the configuration with **various milling heads** covers a **wide range of machining processes**, which Morgenthaler claims is unique in Switzerland.



Movable either together or individually – on the three tables the maximum machining length of 18 metres can be utilised together with all the advantages of setting up during machining.





**HSC** HIGH-SPEED-CUTTING

Milling of deep grooves on a vertical machining centre; save costs and time with HSC milling.

## DMG MORI Expertise in tool and mould making

Tool and mould making is one of the most innovative industries. The requirements on precision and surface finishes could not be more different. From simple moulds to polished tools for transparent plastic parts to structured surfaces.

HSC technology has become one of the major machining trends for tool and mould manufacture. As a global market leader, DMG MORI offers its HSC customers an innovative high-speed range for all possible materials, workpiece dimensions and machining tasks – including the demanding 5-axis simultaneous milling of complex component geometries.

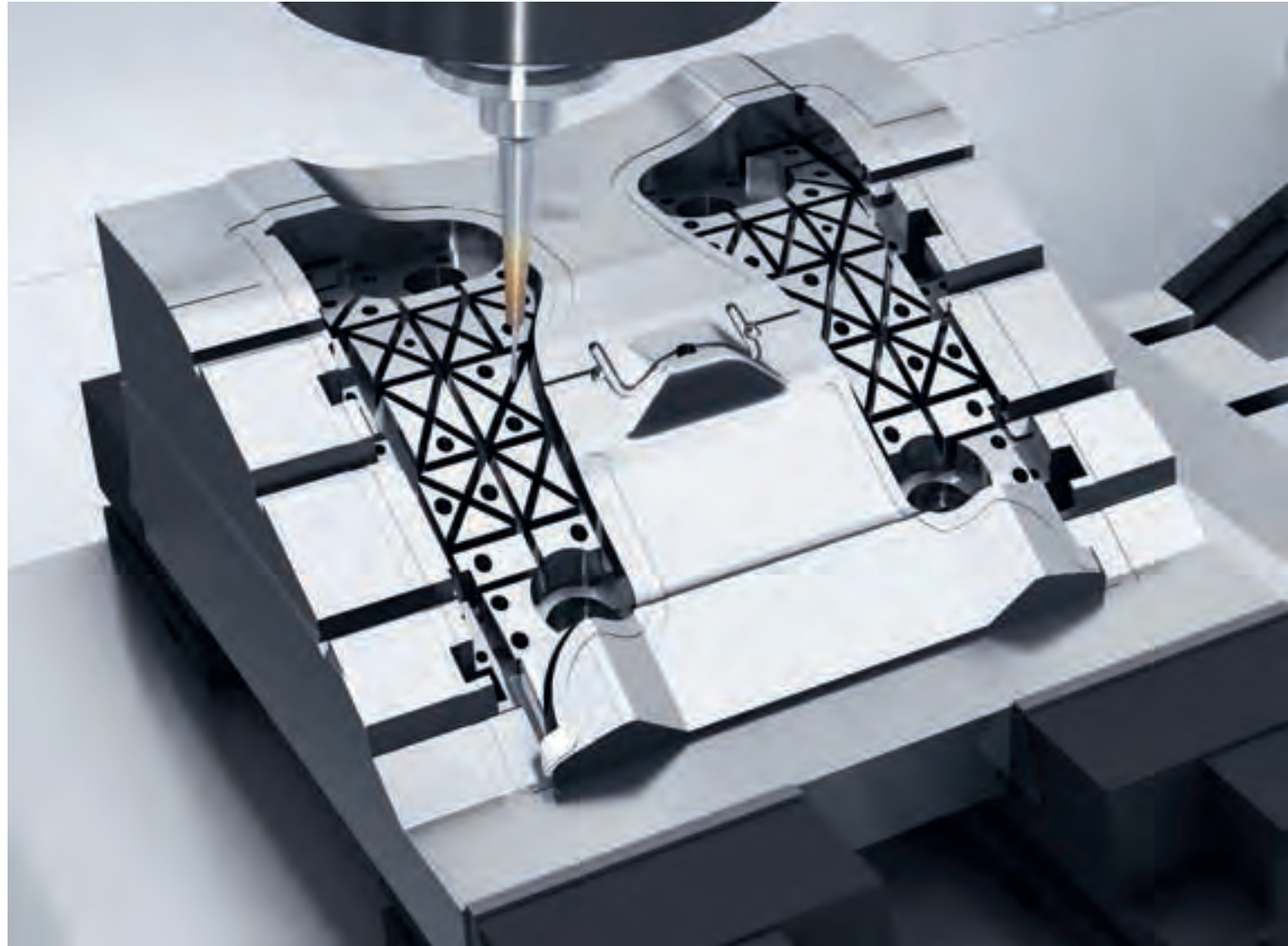

## Top ranges for tool and mould making

### HSC 30 *linear* HSC 70 *linear* Precision in a new dimension

Thermo-symmetrical construction for highest part precision: < 0.005 mm: Linear drives in X, Y and Z with 50 m/min rapid traverse and 1.2g acceleration (80 m/min on the HSC 70 *linear*). HSC spindles rated at up to 40,000 rpm with spindle shaft, flange and jacket cooling as standard.

**CELOS**  
from DMG MORI



Injection mould for headlight  
**Material:** 1.2312  
**Dimensions:** 680 × 400 × 350 mm  
**Ra < 0.15 µm**  
**Machine:** HSC 70 *linear*

**linear** **DRIVE**

**TECHNICAL DATA**  
Travel X / Y / Z: 650 / 600 / 380 mm;  
Rapid traverse: 80 m/min; Spindle speed: 18,000 rpm (28,000 / 40,000); Workpiece weight: 700 kg;  
Tool magazine: 30 (60 / 120) stations

### NMV 5000 High-precision 5-axis machining centre

5-axis machining with DCG technology, highly dynamic direct drives and the new MAPPS IV dialogue control system as standard.



Mould for engine components  
**Material:** SKD61  
**Dimensions:** 330 × 200 × 200 mm  
**Machining time:** 9 hours 20 minutes  
**Machine:** NMV

**TECHNICAL DATA**  
Travel X / Y / Z: 320 / 300 / 280 mm;  
Rapid traverse: 50 m/min; Spindle speed: 40,000 rpm; Workpiece weight: 200 kg;  
Tool magazine: 30 (60) stations



## HSC centre in Geretsried in Munich

## Mould laboratory, Nara in Japan

HSC centre, Geretsried in Munich.



Mould laboratory, Nara in Japan.



High material removal rates, long tool service lives and maximum process reliability hand-in-hand with optimal dimensional accuracy and contouring precision in the  $\mu\text{m}$  scale and workpiece surface finishes of up to **Ra 0.2** are state of the art here.

Those interested can find everything they need to know about tool and mould making in our **centres of excellence in Geretsried and Nara**. Our **experienced application technicians** carry out **trial processes**, provide support with programming and tool selection and **develop milling strategies and trends for the future**. In cooperation with our **technology partners**, we provide holistic solutions for tool and mould manufacture.

The **mould laboratory in Nara** houses both electrical discharge and injection moulding machines, and is therefore capable of carrying out the **full process up to mould proving**. The range of services of our centres of excellence is rounded off by a comprehensive and **interesting range of workshops**.

Naturally, the **innovative products of DMG MORI** for tool and mould making are available for **demonstrations**. Arrange a visit!



Experience the full process chain of the latest HSC technology live in our centres of excellence.

### NVD 5000

#### Vertical machining centre for mould making

High speed, machining accuracy, stability and ease of use. We have designed the ideal vertical machining centre as a way of providing our customers with these functions – the NVD range.



(Segment of a) tyre mould  
**Material:** SKD61  
**Dimensions:** 190 x 170 x 70 mm  
**Machining time:** 14 hours 21 minutes  
**Machine:** NVD

**TECHNICAL DATA**  
Travel X / Y / Z: 650 / 600 / 380 mm;  
Rapid traverse: 80 m/min; Spindle speed: 18,000 rpm  
(28,000 / 40,000); Workpiece weight: 700 kg;  
Tool magazine: 30 (60 / 120) stations

### NVX 5100

#### Machining of mould components weighing up to 1,200 kg

The NVX 5000 range provides increased machining efficiency thanks to the increased spindle speed. Outstanding stability and damping thanks to the use of linear guides in all axes.

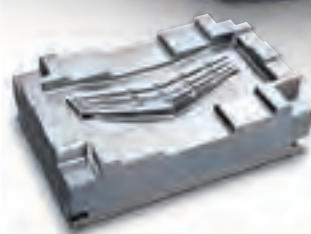
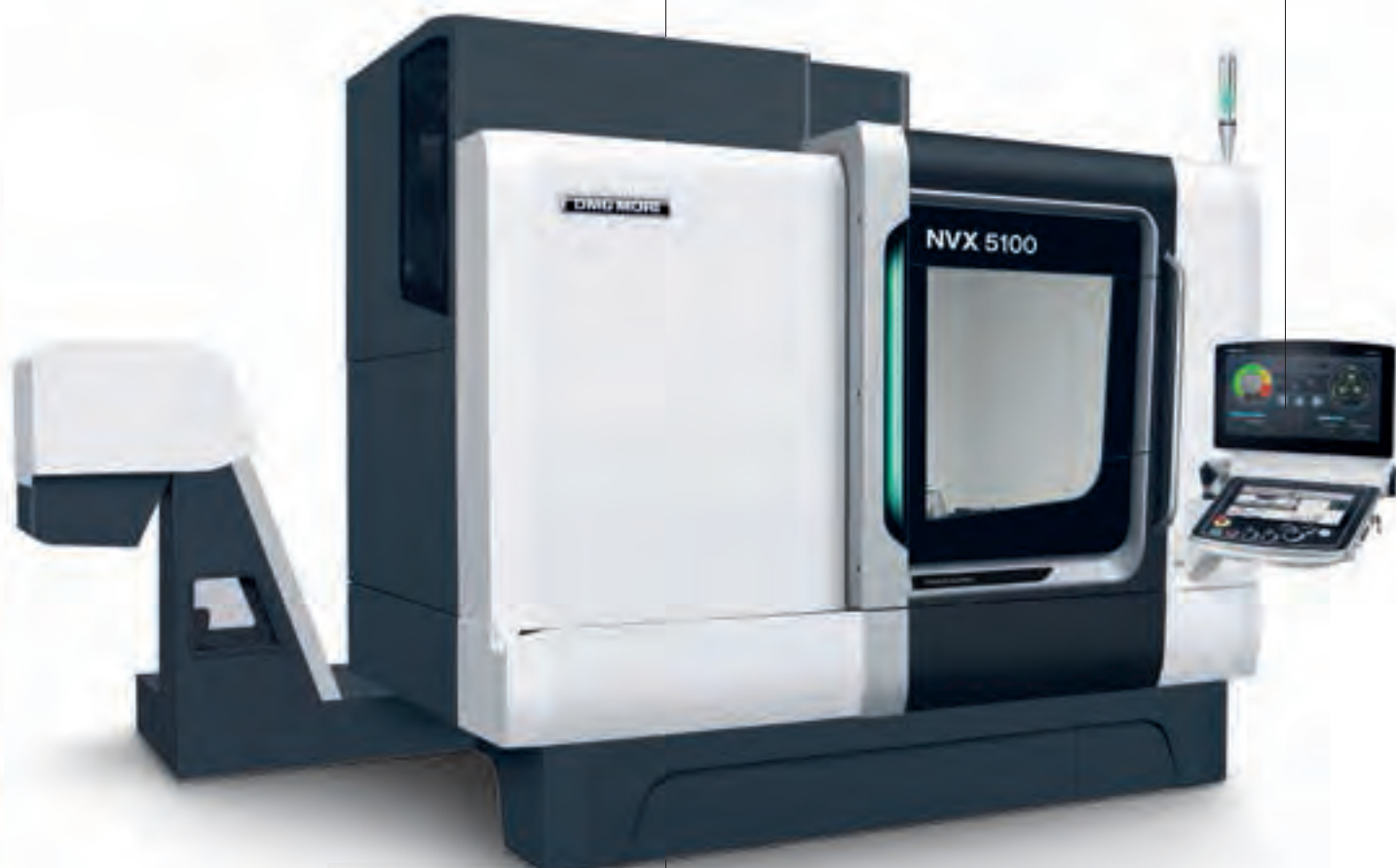

Mould for radiator grille  
**Material:** SKD61  
**Dimensions:** 700 x 450 x 150 mm  
**Machining time:** 33 hours  
**Machine:** NVX

**TECHNICAL DATA**  
Travel X / Y / Z: 1,050 / 530 / 510 mm;  
Rapid traverse: 30 m/min; Spindle speed: 13,000 rpm  
(12,000); Workpiece weight: 1,200 kg;  
Tool magazine: 30 (60 / 90) stations

**CELOS**  
from DMG MORI



## DMU / LASERTEC Shape

## Customer stories

## MÜLLER Modell- und Formenbau GmbH & Co. KG

Productive and reliable with DMU machining centres.

Established in 1922 as a model and machine factory, **Müller Modell- und Formenbau GmbH & Co. KG** quickly grew to become a skilled provider in the tool making sector. The development and production of **complex injection mould tools for car production** has been the core skill of the company since the 1950s and has built a good reputation for the mould makers amongst famous vehicle manufacturers. The success is also due in part to the innovative focus on production: Its range of machines includes **20 machining centres from DMG MORI**, including two **DMU 340 P**, five **DMU 210 P / 200 P** and one **DMU 125 monoBLOCK®**, which was installed for Müller as a pilot project.

**Reliability, machining quality and diversity** are the deciding factors for company owner Georg Müller to purchase machines from DMG MORI. However, the **30-year partnership** is not only based on close cooperation with the supplier: **'Skilled service** is just as important for our productivity as the performance of the machining centres.' By becoming a pilot customer in 2014, Müller has reaffirmed that the cooperation with DMG MORI is working well: This summer, DMG MORI installed the first **DMU 270 P** at the mould makers.

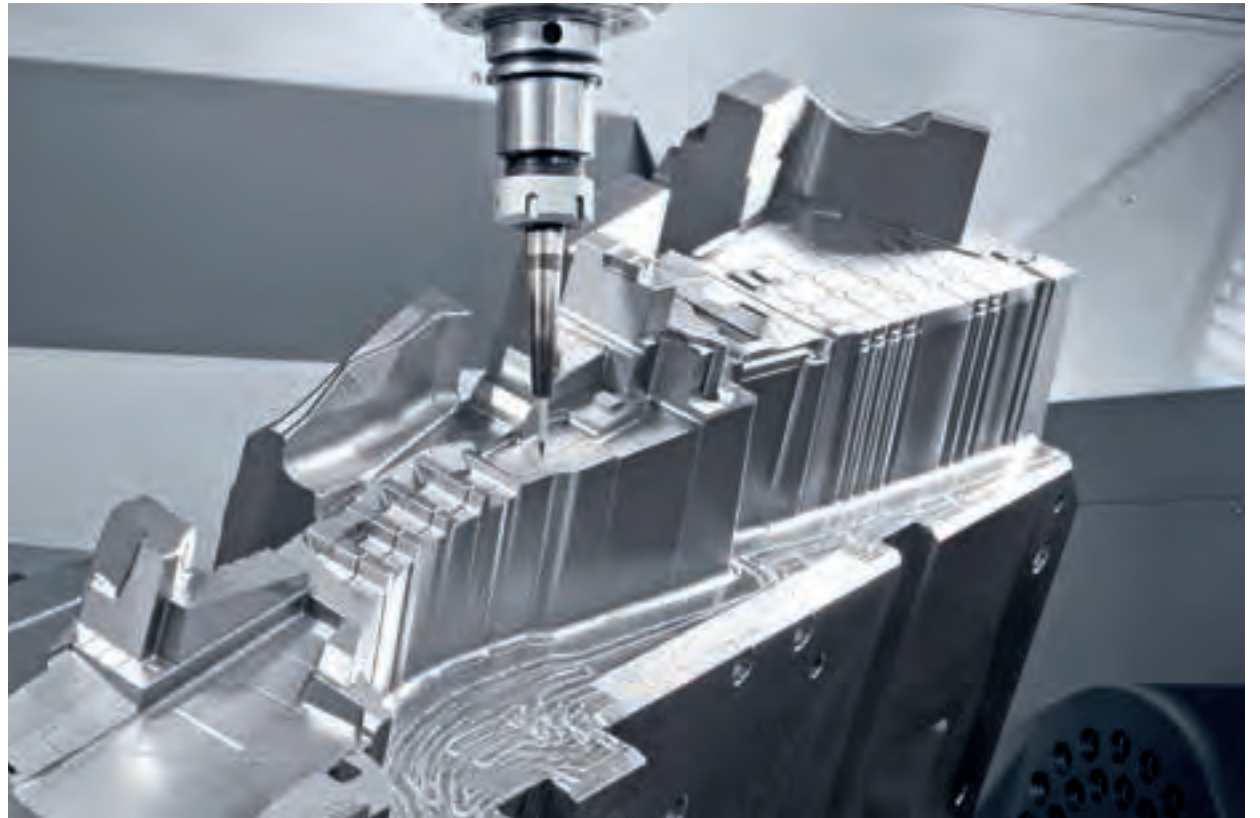

Since the 1950s, the development and production of complex injection moulding tools for car production have been the core skills of Müller.



A family-run company: After Georg Müller (left), his son Marius Müller will be the fourth generation of the family to run the business.

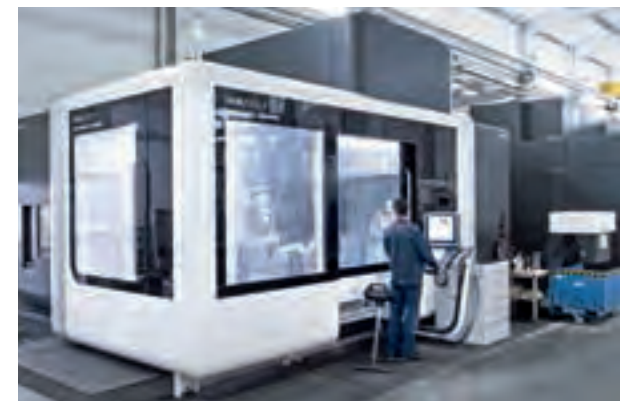

The 20 DMG MORI machining centres used by Müller include one DMU 210 P. The company recently also invested in a DMU 270 P.



Contact:  
Müller Modell- und Formenbau GmbH & Co. KG  
Hohe Straße 6-10, 35216 Biedenkopf  
info@mueller-wallau.de, www.mueller-wallau.de



The ability of the LASERTEC 125 Shape to laser texture mould tools in five axes will replace the highly intensive and environmentally unfriendly etching process.



Aluminium steering wheel foam tool and sample with various surface structures (including honeycomb, lattice and checked textures).



Owner Thorsten Michel in front of his company in Lautert: On 29 October 2013, T. MICHEL Formenbau was awarded the ARPRO Adventure 2013 Award for the most innovative technical mould component – manufactured on a LASERTEC 65 Shape.

## T. MICHEL Formenbau GmbH & Co. KG –

'Always one step ahead! LASERTEC Shape technology makes it possible!'

For over 10 years, the medium-sized family company T. MICHEL Formenbau, based in Lautert and consisting of 40 employees, has developed and produced **tools and moulds for the plastics processing industry**. Its services range from product development, 3D design, 3D digitisation and prototype construction and tool maintenance to the mechanical processing of particle foam, injection and deep drawing tools for mass production. The **automotive, packaging and toy industries**, as well as the **building and construction industry**, are some of the company's most important fields of application. In order to keep its production facilities state of the art, T. MICHEL Formenbau has just invested in **cutting-edge SHAPE technology** from DMG MORI.

The new **LASERTEC 125 Shape** was installed and became operational in Lautert in April of this year. **'The LASERTEC Shape is unique in the world!'**, says owner Thorsten Michel. **'This innovative hybrid machine combines milling of the actual mould with continuously accurate surface structuring with a laser! All of this takes place in one clamping, which gives us the necessary precision and, most importantly, saves valuable time.'** The level of demand from customers is high. **'In one year at the latest we will have a second, probably larger, LASERTEC machine'**, says Thorsten Michel with certainty. **'This new process allows for boundless design options!'**



Contact:  
T. MICHEL Formenbau GmbH & Co. KG  
In der Zeil 10, D-56355 Lautert  
info@michel-form.de, www.michel-form.de





## MAGNESCALE – A DMG MORI COMPANY

# Magnescale

**SPEED X PRECISION**

### Maximum precision thanks to magnetic measurement systems with 0.01 µm.

More than 45 years' experience in development and production of high precision linear and rotary encoders for machine tool and semiconductor applications.

\_\_\_\_\_ Magnescale Co. Ltd., established in 2010, is a global leading precision technology company with headquarters in Isehara, Japan, and subsidiaries in Cypress (CA), USA, and Wernau, Germany. The company develops, designs and manufactures products, which are known as the product groups called Magnescale, Laserscale and Digital Gauge. This lineup makes it possible to take measurements in a **wide range from µm to even picometer**. Production plants are located in Isehara and Iga, Japan. Furthermore a new production plant has been built in Wernau to strengthen business in Europe.

\_\_\_\_\_ Magnescale products, which originated from tape recorder magnetic storage technology and boast **high resistance to environmental stresses**

and offer exceptional precision and high resolution, have spurred progress in the machine tool industry. In addition to environmental resistance under severe operating conditions such as humidity or oil, Magnescale Encoders have **same thermal expansion coefficient as the iron** used in the structure of machine tools. With this characteristic, these scales can deliver high precision positioning and stability even if they are exposed to vibrations.

[www.magnescale.com](http://www.magnescale.com)

CONTACT

**JAPAN:** Yoshiki Kato  
 yh-kato@magnescale.com



**USA:** Steve Petrillo  
 petrillo@magnescale.com



**EUROPE:** Martin Gass  
 mgass@magnescale.com



Magnescale office in Isehara.



Magnescale in Iga, Japan and in Wernau, Europe.

#### SR27A / SR67A Series\*



Magnetic absolute linear encoder with slim design (SR27A) or robust design (SR67A).

#### RS97 Series\*



Magnetic absolute rotary encoder with open type design for limited installation space.

#### RU97 Series\*



Magnetic absolute rotary encoder with integrated bearing. Perfect for integration in high precision rotary tables.

#### DK800S Series



Measuring range: 5 mm to 205 mm  
 Accuracy: ±0.5 µm to ±3 µm  
 90 million strokes achieved

#### Laserscale

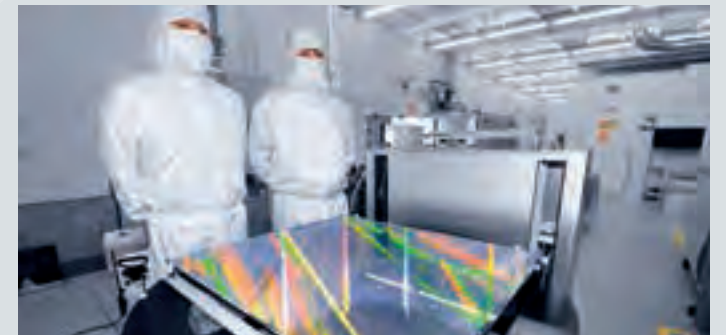

Allows resolutions down to 17 picometres. For applications in the semiconductor industry and ultra-precision machining.



The measurement systems are not impaired by oil or condensation.

- \_ Protective structure
- \_ Resistance to condensation and oil
- \_ Impact resistance of 450 m/s<sup>2</sup>
- \_ Vibration resistance of 250 m/s<sup>2</sup>
- \_ Thermal expansion coefficient as cast iron



\* Magnescale Encoders with Siemens DRIVE-CLiQ interface protocol provide Functional Safety.



**ecoTurn** HIGHEST FUNCTIONALITY, BEST PRICE

## ECOLINE turning technology: *ecoTurn*

The range of turning machines with dynamic turrets and 3D control systems at the **best price**.

— See the 2014 ECOLINE range with the **HIGHEST FUNCTIONALITY** at the **BEST PRICE** for yourself. To save you from having to make as many compromises when choosing your ECOLINE turning machine in the future, we have added two new developments to accompany the *ecoTurn* 310 and *ecoTurn* 510: the *ecoTurn* 450 and *ecoTurn* 650. The new sizes complement the range perfectly: with cutting diameters of  $\varnothing$  200–600 mm we always have the right machine in terms of price and performance for your hard turning requirements. All ECOLINE turning machines feature the fastest 3D control systems with a 15" TFT monitor, with optional extras

including C axis, driven tools and rapid brand-name servo turrets. The stick-slip free linear guides allow the machines to attain the best precision and surface finishes. All the devices have been selected in order that the output matches the application and no energy is wasted. Overall, the machines are economically in tune with the times with their small footprints: **In terms of the ratio between working area and space requirements, the *ecoTurn* 450 is the benchmark on the market!**

**NEW: *ecoTurn* 450 / *ecoTurn* 650** – The two newest machines for chuck sizes of  $\varnothing$  250 mm and  $\varnothing$  400 mm\*\*

- VDI 40/50\*\* turret with 12 tool stations as standard
- Optional rapid servo turret with 12 driven tool stations and 6 block tool holders
- Chip conveyor at the rear, 30 % less width (optionally available for the *ecoTurn* 450)

\*\*For the *ecoTurn* 650



\*Optional

Schematic layout; the machines depicted may deviate from the standard configuration.





**D & A Fernandes**  
Germany  
Managing Directors  
Domingos and Artur Fernandes

» The ECOLINE models provide consistently high quality standards, which our customers also expect from us. However, DMG MORI still offers the ECOLINE range at attractive prices. «

The company owns two ecoTurn, three ecoMill and three ecoMill V machines.



**Pacific International University**  
Russia  
Head of the Machine Tools Department  
Prof Vladimir Davydov

» Of course, we have done our homework and viewed machines from other manufacturers from the USA, the Czech Republic and other countries, but the ECOLINE machines from DMG MORI are simply the most reliable. «

The university owns one ecoTurn 310, one ecoMill 50 and one ecoMill 635 V machine.



**MART-KAC S.C.**  
Poland  
Managing Director  
Marek Grzelak

» We produce over 1,500 different parts throughout the year. We also produce low quantities of complex workpieces for special-purpose machines or special designs, and our ecoTurn 310 has proven to be the right choice here. «

MART-KAC has invested in one ecoTurn, two ecoMill V and two ecoMill machines.



— Suitability for fulfilling orders and flexibility for the future: with the ECOLINE options kit you have every possibility within your grasp, whether you have to machine challenging individual parts or large batches in a short period of time. You can opt for extended diameters and automated bar machining, as well as a **Y axis for challenging complete machining on the ecoTurn 510**. Steady rests for shaft machining and connection points for the automation cells are available for all machines.



**Your ECOLINE expert:**  
Mr Sven Berhörster  
Tel.: +41 (0) 44 80 / 11 44 2  
E-mail: sven.berhoerster@dmgmori.com

**3<sup>rd</sup> generation SLIMline®**  
The ergonomic control panel provides maximum operating convenience



**ecoTurn 650**  
The highest gear-free torque with a precise C axis

Compact footprint of 9.8 m<sup>2</sup>

**ecoTurn 310**  
Incredibly flexible for chucking up to ø 200 mm and ø 65 mm\* for bar machining

**ecoTurn 510**  
Enormously powerful with Y axis\* and VDI 40 turret



Get the most from your machine with ECOLINE and our exclusive partner Sandvik Coromant.



## Technical data

		ecoTurn 310	ecoTurn 450	ecoTurn 510	ecoTurn 650
Swing over bed	mm	ø 330	ø 650	ø 680	ø 860
Maximum cutting diameter	mm	ø 200	ø 400	ø 465	ø 600
Longitudinal travel (Z)	mm	455	600	1,050	1,150
Bar capacity	mm	ø 51 (65*)	ø 65 (75*)	ø 76 (90*)	ø 102 (110*)
Drive power (40 / 100 % ED)	kW	16.5 / 11	17.5 / 12.5	33 / 22	48 / 41
Maximum speed	rpm	5,000	4,000	3,250	2,250
Torque (40 / 100 % ED)	Nm	166.5 / 112	370 / 280	630 / 420	2,000 / 1,700
Chuck diameter	mm	ø 210*	ø 250* / ø 315*	ø 250* / 315*	ø 315* / ø 400* / ø 500*

\* Optional

## SANDVIK COROMANT TOOL KIT FOR ecoTurn

with six tools for turning, drilling, grooving and thread cutting, as well as six suitable VDI 30 / 40 / 50 tool holders and 70 replacement inserts.



**ecoMill** HIGHEST FUNCTIONALITY, BEST PRICE

## ECOLINE milling technology: *ecoMill* and MILLTAP

The most diverse range of milling machines, up to 5-sided machining with 3D control systems at the **best price**.

ECOLINE offers the most diverse range of milling machines for series production and individual parts machining. The latest 3D control systems with 15" TFT monitors come as standard.

From 3-axis milling to 5-sided machining and from an X traverse of 500 to 1035 mm, we can provide the right solution for every milling task. Energy-efficient devices and stick-slip free guides ensure the best milling results and low power consumption. The optional linear measurement systems ensure the best long-term accuracy and with the comprehensive options kit, ECOLINE milling machines can be standardised to meet your requirements. **The most**

recent and most advanced ECOLINE milling machine is the *ecoMill 70*. With its large working area, 12,000 rpm and 32-station tool change system, it is the best 3 + 2 axis machine in its class. For machining small, demanding parts, the *ecoMill 50* is optionally available with the same features.

The advanced vertical machining centres *ecoMill 635 V* and *ecoMill 1035 V*, which are extremely space-saving thanks to their C-frames, feature the best all-round functions for every business with their wide range of options. For example, a DMG MORI milling spindle rated at up to 12,000 rpm is available for high cutting speeds and the

### NEW: *ecoMill 70*

The entry into 5-sided machining with an NC swivelling rotary table

- Permissible load of 350 kg
- Workpiece mounting surface of  $\varnothing 800 \times 620$  mm
- Swivel range from  $-10^\circ$  to  $+95^\circ$
- Table clamp hydraulic / automatic including electronic angle display and plane transform

5-sided  
machining

B axis  
 $-10^\circ / +95^\circ$

C axis  
360°

### *ecoMill 50* *ecoMill 70*

The top of its class:  
flexible and precise  
with the patented  
2-axis table



Get the most from your machine with ECOLINE and our exclusive partner Sandvik Coromant.

#### SANDVIK COROMANT TOOL KIT FOR *ecoMill*

with four high quality milling tools of the CoroMill® series and tool holder – optionally ISO 40, BT 40, CAT 40 – as well as 30 high performance milling inserts.



Schematic layout; the machines depicted may deviate from the standard configuration.





**Siemens AG**  
Germany  
Head of Training, Ruhstorf  
Josef Wenig



**Active Company Limited**  
Japan  
President  
Tetsuya Nishiyama



**Billion Technology Ltd.**  
China  
Managing Director  
Zhang Lingfeng

» The ecoMill 50 machines are ideal for training as they incorporate almost every important feature in machining today. Thanks to its B axis, the machine is designed in such a way that collisions virtually never occur – especially in training this really is a deciding factor. «

» The ecoMill 635 V meets the extremely high precision requirements of the motorsport industry. It was definitely the best choice as it stands out from the rest with its high rapid traverses and high-speed spindle, and it is even able to carry out delicate boring work efficiently. «

» The high quality requirements of our customers make it necessary to work efficiently, i.e. to lower manufacturing costs and increase the level of quality at the same time. Our seven ECOLINE machines help us optimise the production processes to meet these requirements. «

Siemens AG uses two ecoMill 50 machines in its training workshop.



Active Company machines its motorsport products on an ecoMill 635 V.



The company owns two ecoTurn, three ecoMill V and two MILLTAP 700 machines.



best surface finishes. When it comes to eliminating unnecessary non-productive time, the MILLTAP 700 is the machine of choice. With its rapid tool change system and dynamic axes, the MILLTAP 700 is the ideal platform for a range of machining processes. With its comprehensive options kit, in the blink of an eye the MILLTAP 700 can be configured as a 5-axis high-performance centre with speeds of up to 24,000 rpm. However, even as standard the MILLTAP delivers impressive results: 10,000 rpm and a 15-station tool change system at an attractive entry-level price!

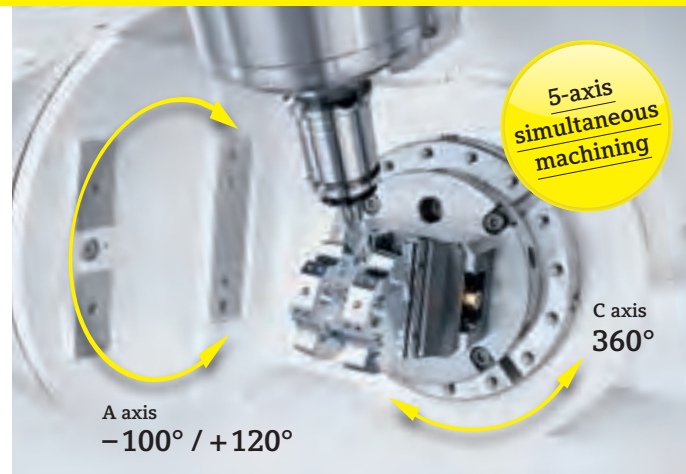

Even more efficient and flexible thanks to the optionally integrated 4<sup>th</sup> / 5<sup>th</sup> axis – a DMG MORI model (DDR).



WH 2 | WH 3 workpiece handling. High degree of autonomy with short cycle times, small footprint and high workpiece storage capacity.

**ecoMill 635 V**  
**ecoMill 1035 V**  
Compact and powerful with a 3D control system



**MILLTAP**  
The platform for the highest production requirements



**ECOLINE**  
ready for automation

**Technical data**

		ecoMill 50	ecoMill 70	ecoMill 635 V	ecoMill 1035 V	MILLTAP 700
Traverse (X / Y / Z)	mm	500 / 450 / 400	750 / 600 / 520	635 / 510 / 460	1,035 / 560 / 510	700 / 420 / 380
Speed	rpm	8,000 (10,000*)	12,000	8,000 (12,000*)	8,000 (12,000*)	10,000 / 10,000 high torque* / 24,000*
Torque (40 / 100 % ED)	Nm	83 / 57	83 / 57	83 / 57	83 / 57	12.5 / 8; 45 / 29 (max. 78)*; 12 / 8*
Drive power (40 / 100 % ED)	kW	13 / 9	13 / 9	13 / 9	13 / 9	6.7 / 4.5; 6.5 / 4.5 (max. 13.6)*; 6 / 4*
Tool stations		16 (32*)	32	20 (30*)	20 (30*)	15 (25*)
Rapid traverse	m/min	24 / 24 / 24	24 / 24 / 24	30 / 30 / 30	30 / 30 / 30	60 / 60 / 60
Table load	kg	200	350	600	1,000	400 / 100**
NC swivelling rotary table	Degrees	-5 / +110	-10 / +95	-	-	-100 / +120

\*Optional / \*\*Price for the MILLTAP 700 with integrated 4<sup>th</sup> / 5<sup>th</sup> axis

**Sandvik Coromant tools:**  
More productivity!  
Sandvik Coromant tools suitable for the MILLTAP 700 from DMG MORI.





**ECOLINE**

HIGH-END CONTROL SYSTEMS AT THE ECOLINE PRICE

**3D control technology for every application.**

Irrespective of what your demands for performance of a modern control system may be and what your preferences are. Do not settle for compromises: time is money. That's why ECOLINE provides **the right 3D control technology for every user with the fastest systems.** Whatever you want and need, we will supply **optimal hardware and software solutions** for the entire process chain – from the drawing to the completed workpiece.



**SLIMline® with MAPPs IV with MITSUBISHI**

15" TFT display with 3D workpiece simulation  
Storage: 50 MB (6 GB optional)  
Programming: ISO & dialogue programming function  
The HELP button for rapid programming assistance

only available for the ecoTurn 310 / 450 and ecoMill V



**SLIMline® with HEIDENHAIN CNC PILOT 640 / TNC 620**

15" TFT display with 3D workpiece simulation  
Storage: 1.8 GB  
Programming: DIN, plain text programming / smart.Turn  
Block processing time: 1.5 ms  
DMG MORI SMARTkey®

not available for the ecoTurn 650 or MILLTAP 700



**SLIMline® with Operate 4.5 on SIEMENS 840D solutionline**

15" TFT display with 3D workpiece simulation

Storage: 5MB + 4 GB

Programming: DIN, ShopMill / ShopTurn

Block processing time: 1.5 ms

The HELP button for rapid programming assistance

DMG MORI SMARTkey®



Servo Turret (STP)

Single Motor Servo Turret (SMT)

Chain type ATC for Vertical Machining Center

ATC for Horizontal Machining Center

**PRAGATI**

Partnering Machine Tool Builders - Worldwide

Pragati is a leading manufacturer of Tool Turrets and Automatic Tool Changers with a worldwide customer base. More than 46,000 Turrets and 20,000 ATC's in the field are a testimony of the quality, reliability and competitive prices of the products. Turrets and ATC's are available in different sizes to cater to the requirement of every machine tool builder.

**PRAGATI**

Pragati Automation Pvt. Ltd. #19 & 20, (Plot No. 467 - 469), IV Phase, 12th Cross, Peenya Industrial Area, Bangalore - 560 058. INDIA.  
Tel. : (+91-80) 2836-1543 Fax : (+91-80) 2836-1549.  
E-mail : info@pragatiautomation.com URL : http://www.pragati-automation.com



N° 2 – 2014

- DMG MORI Systems – processes perfectly automated
- Expertise in all automation sectors:  
Machine-integrated automation, standard automation,  
flexible production cells and production lines
- Intelligent production lines in Industry 4.0

# DMG MORI Systems



System solutions  
for mass production.

*More on the i 50 production line*

**ON PAGE 42**





DMG MORI SYSTEMS

Analysis, advice and implementation for all automation areas.

### SEGMENT 1

#### Machine-integrated automation



##### Rotary and linear storage

As an option, DMG MORI can supply a variety of automation systems which have already been integrated into the machine. E.g. **Round pallet magazines**: Small footprint and convenient to set up. Easy to control via the machine.

### SEGMENT 2

#### Standard automation



##### Workpiece or pallet handling

Efficient robot or portal solutions with additional modules (cleaning, measuring, deburring, etc.) as plug-and-play solutions or available as customised versions.



##### CPP – Carrier Pallet Pool:

Easy to install, can be expanded for up to 8 machines and 2 set-up stations.

## A complete provider of holistic system solutions.

— In the recently formed **DMG MORI Systems**, DMG MORI is focusing its comprehensive expertise on **holistic system solutions**. The product portfolio ranges from standard automation to flexible manufacturing cells to complete production lines. The Managing Director of **DMG MORI Systems** Silvio Krüger explains: 'We see ourselves as a service provider that always designs and configures the best solution based on the specifications of our customer.' The range of **DMG MORI Systems** makes a considerable contribution to 'Industry 4.0' as the process and supply chains are systematically linked, thus significantly increasing the flexibility of our customers in production. 'Our **production lines** and **flexible manufacturing cells** are a major part of such intelligent workshops as they represent **complete machining processes**', explains Silvio Krüger.

Silvio Krüger sees the central hallmark of **DMG MORI Systems** as the holistic, optimally **coordinated system of technology, machine tools and automation solutions**: 'Our customers benefit from the fact that they will receive **holistic system solutions from a single source, ranging** from the design of the system solution to the technology to the turn-key project. The **full range of DMG MORI Systems** guarantees that our customers can manufacture even more efficiently and with certainty of future viability.'



Silvio Krüger  
Managing Director

Contact: DMG MORI Systems  
Antoniusstr. 14, 73249 Wernau  
Tel.: +49 (0) 7153 / 934 – 0  
E-mail: [silvio.krueger@dmgmori.com](mailto:silvio.krueger@dmgmori.com)

Our online amortisation computer immediately shows you the cost advantages of our standard automation systems.

You can find everything to do with automation and the services of DMG MORI Systems online at

→ [www.dmgmori.com](http://www.dmgmori.com)

All in one place!  
We can organise and configure all material handling for you.

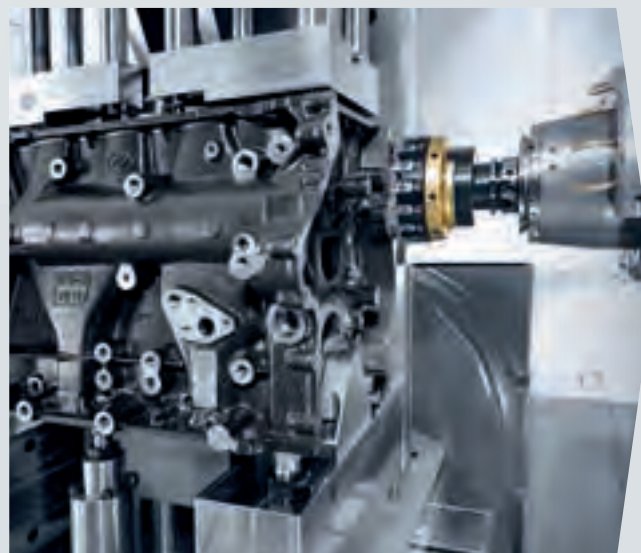

Technology







Machine



## DMG MORI Systems worldwide.



5 sites in Europe, Japan, China and the USA

-  › Wernau and Hüfingen, Germany
-  › Davis, USA
-  › Nara, Japan
-  › Tianjing, China

Our all-round solution expertise – innovative project management for thorough and transparent project implementation.

System planning	Production logistics	Start-up support
<ul style="list-style-type: none"> <li>› Process analysis</li> <li>› Technology planning</li> <li>› Machine design</li> <li>› Cycle time calculation</li> <li>› Simulation</li> </ul>	<ul style="list-style-type: none"> <li>› Automation planning</li> <li>› Material flow analysis</li> <li>› Layout planning</li> </ul>	<ul style="list-style-type: none"> <li>› Training</li> <li>› Process visualisation</li> <li>› Back-up strategy</li> <li>› Remote diagnostics</li> </ul>

### SEGMENT 3

#### Flexible production cells



**Linking of several process sequences**  
 Portal solutions, fixed or mobile robots and additional modules for multi-machine loading with integration of additional operations.



**The LPP (linear pallet magazine)**  
 allows flexible adaptation to a customer's requirements.

### SEGMENT 4

#### Production lines



**Overall solutions in series production**  
 Planning and implementation of pallet, portal and robot handling as a production line, including host computer system.



Automation



Peripheral equipment



## SEGMENT 2

## Customer stories



The integrated workpiece storage for parts weighing up to 300 kg guarantees safe and efficient supply of billets.



The raw and finished parts grippers of the WH25 handling robot are designed for parts weighing up to 25 kg.



FAES COO Matthias Weibel (left) and Production Manager Daniel Beeler are excited by the sometimes halved throughput times.

## FAES AG – Robot handling instead of manual chucking.



Contact: FAES AG  
Roosstrasse 49, CH-8832 Wollerau  
info@faes.com, www.faes.com



— The production company **FAES**, established almost 100 years ago, manufactures products exclusively at its location in Switzerland with an array of high-tech machines. No compromises are made in terms of **precision, reliability and quality**, which epitomises the name FAES and the production site close to Zurich. Besides developing its own machines for **cutting and wrapping** foil and film, on behalf of technology companies in all sectors FAES produces **precision parts, assemblies and complete machines**. The automation of processes and production is constantly being driven forwards with the goal of being able to offer customers Swiss quality at East European prices. Its latest investment, a **high-performance NZX 2000|800SY2 turning centre** and a **WH25 handling robot**, have been ensuring dynamic automated production of small batches

with minimised loading times. 'With this latest investment we **boosted our productivity by almost 30%**', explains COO Matthias Weibel. The handling robot allows set-up during machining and gives us the option to **produce automatically**. 'Whereas on a milling machine we sometimes had to handle a part up to four times during manufacture, with the new **NZX** and thanks to **set-up during machining, we now save half the time**', says Daniel Beeler, Production Manager at FAES. It is clear to Beeler that for many components, machining from bar is much more efficient than machining on a milling centre. That's why the turning centre was equipped with a short bar loader.



Sören Gaiser, the owner of Gaiser-Mechanik, is happy with the two automation systems: 'We have turned night into day.'



Gaiser-Mechanik can supply its customers even faster thanks to the DMU 50 with WH10 handling system.



The workpiece storage with two drawers provides enough space even for extended automated operation.

## GAISER- MECHANIK GmbH – Turn night into day.

Contact: Gaiser-Mechanik GmbH  
Taubenäckerweg 5, 72655 Altdorf, Germany  
gaiser-mechanik@online.de



— Since it was founded in 1985, **Gaiser Mechanik GmbH** from Altdorf has successfully positioned itself as a **contract manufacturer**. The 16-strong company focuses on machining **demanding aluminium components** for a wide range of sectors including **medical and automation technology**. Since 2009 Gaiser Mechanik has been meeting its high production requirements with **CNC technology from DMG MORI** and since 2011 with automation solutions from DMG MORI Systems. **Two DMU 50 machines with WH10 handling systems** ensure higher productivity, even outside normal working hours. 'Thanks to our first set of automated processes, for three years we have been able to **supply our customers even faster**. We want to consolidate this advantage with a second automated system, Sören Gaiser says of the expansion to the com-

pany's automated production made in early 2014. Thanks to their **compact designs**, the automated cells fit perfectly into the production facilities of Gaiser Mechanik. Both systems are equipped with a **6-axis robot** which can load and unload **components up to 10 kg** reliably. The workpiece storage with two drawers provides enough space even for extended automated operation. With these two handling systems, Gaiser Mechanik will be able to meet its deadlines in the future – even considering its expected growth. In particular, the company can now easily process **workpieces with long running times** by the following day – **in one clamping** and controlled by the integrated measuring sensor. Sören Gaiser summarises the situation in a few words: '**We have turned night into day.**'





At the end of 2013 DMG MORI Systems installed a production cell at Xylem consisting of two CTX beta 800 lathes, one CTX beta 800 *linear* and a robot.



Two conveyors handle loading and unloading of the production cell. All other processes, including integral measuring of the workpieces, are carried out completely automatically.



The steady rest of the CTX beta 800 *linear* serves to stabilise the workpiece during subsequent milling of grooves and bores.

## XYLEM – Complete machining including real-time quality control.

—Xylem (XYL) is a leading global water technology provider. The Flygt brand is one of the market-leading product lines owned by Xylem and throughout the last half century Flygt has been one of the innovative leading brands in the water technology business. The main Flygt production site is located in Sweden and was founded in 1901. Components are still produced at the original site, 98 percent of which are exported to the factories of the now American corporate group that are spread all over the world. The state-of-the-art plant is the platform for the high standard of quality of the products. The latest example of innovative production is an automation solution from DMG MORI Systems consisting of two CTX beta 800 lathes from GILDEMEISTER, one CTX beta 800 *linear* and a robot. Since 2013 Xylem has been machining shafts for

waste water pumps in the stand-alone production cell – with **signification benefits for productivity**: loading and unloading is effected via two conveyors while the robot loads the workpieces into the machines for the individual machining steps – roughing, turning operations, finishing and groove and bore milling. Fredrik Gereborg, project manager at Xylem, is **more than satisfied** with the cost-saving process: “Not only do the shafts come out of the production cell **completely machined, but a measuring system** is also integrated. Correction of dimensions is carried out automatically in real-time, making **final quality control a thing of the past.**”



Contact: Xylem  
Utvägen 1, SE-361 80 Emmaboda  
info.sverige@xylem.com, www.xylem.com





## SEGMENT 4

**i 50 – Production line for cylinder blocks**

Five i 50 machines with gantry loading, including a 2-arm gantry loader, a washing station and workpiece conveyors.

- › Maintenance space between machines: 600 mm
- › Pitch between machines: 2,090 mm (gantry-type loader specification)



## i 50 – Revolutionary concept for flexible and space-saving mass production.

### Fully automated machining process



#### Pick up rough cylinder block from workpiece conveyor

After picking up the rough cylinder from the conveyor, the gantry loader unloads a finished component from the first machine.



#### Gantry loader –

Cylinder block unloading through an overhead door.

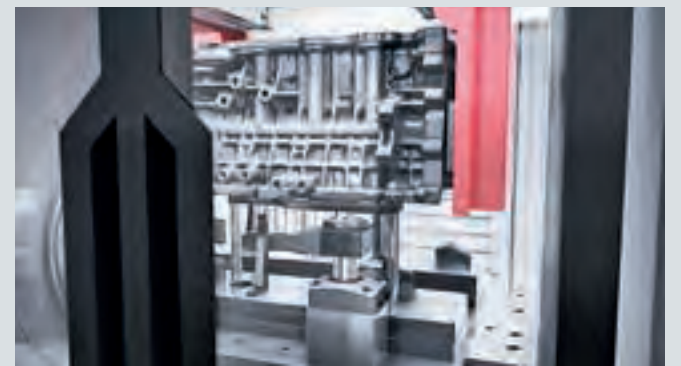

#### Automatic clamping fixture –

After loading by the gantry loader, the fixture automatically clamps the cylinder block.

### The optimum machine for production lines.

- › Compact Horizontal Machining Centre without APC
- › Ideal for the production of cylinder heads and cylinder blocks
- › Machine width: 1,490 mm (gantry-type loader specification)

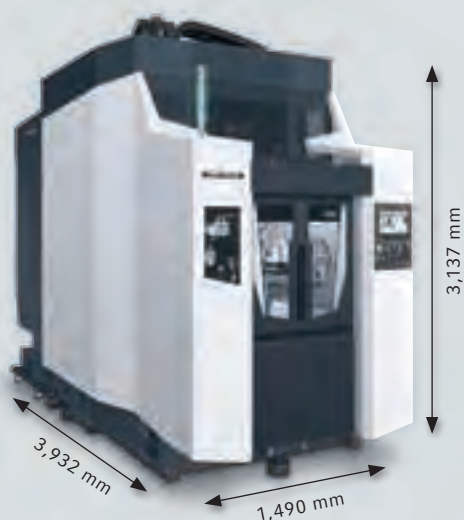

### Reduced loading cycle time.

- › Minimised gantry loader stroke, 585 mm only from roof (1,855 mm) to table (1,270 mm) for short idle times

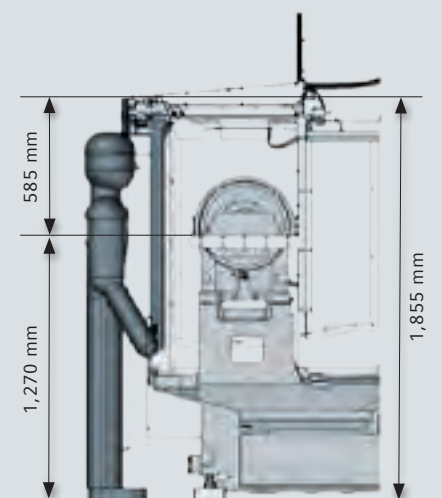





**Horizontal cylinder bore machining –**  
 After tilting the A-axis table automatically,  
 cylinder block boring follows.



**Washing Station**  
 Washing the finished cylinder block  
 and unloading onto the conveyor.



**Flexible work transfer method.**

- Flexible workpiece transfer**
- › Cover shape changeable depending on customer needs
  - › Various transfer methods such as for manual or automatic workpiece handling



Manual transfer (Roller conveyor specification)



The video on i50 automation:  
[www.i50.dmgmori.com](http://www.i50.dmgmori.com)

If your mobile phone has QR code recognition software,  
 you will get straight to the video.



PERFORMANCE PARTNER SIEMENS

## Seamless robot integration – with SINUMERIK Integrate Run MyRobot.

With SINUMERIK, Siemens provides the ideal CNC equipment for machine tools in all major industries. Now, SINUMERIK will also allow for the easy integration of robots into the production environment.

**Dr Neuhauser, why have you spurred on the integration of robots into SINUMERIK CNC technology and what will the benefits be for users?**

**DR NEUHAUSER** \_\_\_ We are following the current trend towards automated production. Full integration of robots into the production chain and automation in general are invaluable in terms of making production highly flexible and fully automatic. With SINUMERIK Integrate Run MyRobot, we are providing a solution for the integrated operation, programming and diagnosis of robots within SINUMERIK Operate. This way, using parallel channels the execution of machine tool and robot programs can eas-

ily be tracked and controlled on screen from a central point. By using SINUMERIK Operate, machine operators are not forced to develop any specialist knowledge of robots – they simply have to be able to focus on the production from the outset. The first DMG MORI machines with Run MyRobot will be the NTX 1000 and MILLTAP.

**Is the robot trend not part of a larger trend; the general integration of IT into machine tools?**

**DR NEUHAUSER** \_\_\_ Yes, that is the case. Future production will require ever more intelligent solutions for even higher productivity and efficiency. On the road towards Industry 4.0, the SINUMERIK Integrate for Production product suite will provide integration solutions for IT in production facilities. Machines will communicate with higher level management and control systems. Thanks to the comprehensive range of Siemens products, PLM and MES systems can easily be connected. By the way, we are not new to IT integration. We have had a long and successful presence on the market with solutions such as Transline for integrating machines into automotive manufacturing. Thanks to this experience and the latest technology, SINUMERIK 840D sl is the best solution for machine-integrated automation, standard automation, flexible manufacturing cells and even for production on a single machine.

**You mentioned machining with SINUMERIK 840D sl. What are the current highlights here?**

**M. TOLKMITT** \_\_\_ SINUMERIK 840D sl is now the benchmark in the CNC market. This applies both to operation with SINUMERIK Operate and to the supported technolo-

gies such as turning, milling and multi-tasking. Especially in mould making, the control system improves cost-effectiveness with better simulation, greater ease of use and flexibility for the user. This is made possible by our SINUMERIK MDynamics technology package for 3 and 5-axis milling applications, including HSC milling (high-speed cutting).

Therefore, machine operators will benefit from the best machining results with perfect surface finishes, precision, quality and speed, all combined with very easy and efficient operation: Only SINUMERIK can make this possible.



Dr Robert Neuhauser, CEO of Motion Control, speaking to Matthias Tolkmitt, Business Development SINUMERIK.



## SINUMERIK Operate

The intuitive and uniform user interface for all technologies on your DMG MORI machine.

[siemens.com/sinumerik](http://siemens.com/sinumerik)

Clear layout, intuitive operation and many powerful new functions - the SINUMERIK® CNC user interface makes it easier than ever to operate your machine. By combining production steps setup and high-level programming on one interface, NC programming and

production planning is quick and efficient. Whether turning or milling operations - the look & feel is the same. And, with intuitive features like animated simulation and screenshots, you always have optimal support.



Answers for industry.



N° 2 – 2014

- DMG MORI spindle service
- Maximum productivity thanks to the DMG MORI service
- Produce more efficiently with tool pre-setting
- NEW // DMG MORI Online Shop
- Process optimisation with DMG MORI software solutions
- Save energy costs with GILDEMEISTER energy solutions

# LifeCycle Services





## LifeCycle Services – Our skills for your productivity.



**Dr Maurice Eschweiler**  
Board of Industrial Services  
DMG MORI SEIKI  
AKTIENGESELLSCHAFT

‘With the products and services of DMG MORI LifeCycle Services, you can maximise your productivity over the entire life cycle of your machine.’

DMG MORI LifeCycle Services – this means products and services over the entire life cycle of your machine. Our services range from preventative service to maintain your **machine availability** and application training for more efficient machining to high-precision tool pre-setting devices for **maximum productivity**. With these services DMG MORI LifeCycle Services ensures that your machine always runs reliably and attains the **highest workpiece quality**. Our services will also extend the **service life** of your DMG MORI machine and increase the output of your production through **process optimisation**. We are on site for you around the world. You can find a guide to everything available from DMG MORI LifeCycle Services in our **service and accessories catalogue**.

As part of a major benchmarking study carried out by the Institute for Industrial Management (FIR) of RWTH Aachen University, DMG MORI proved to be a **top performer in service** when compared with over 100 companies. In particular, the service processes and structures with regard to **service quality, reaction speeds and customer satisfaction** were assessed. The panel of experts concluded that the **professionalism of the DMG MORI service** was a leader across the various sectors.

## And the winner is ... DMG MORI!

We won the accolade of TOP Performer in service and won the benchmarking study ‘Lean Services 2014’.

COMPETENT, FAST AND RELIABLE

# DMG MORI

## Spindle service. On site around the world.

At DMG MORI spindle service, every case is of the highest priority in order to minimise downtime and allow your production to start again quickly. A team of specialists is ready on our hotline to find the right solution for you as quickly as possible. Be it spindle repairs or our spindle replacement service, DMG MORI has the full flexibility of a manufacturer.

### Spindle repairs

- › **Repairs** by the manufacturer within a few working days (DECKEL MAHO, GILDEMEISTER, GRAZIANO, MORI SEIKI, FRANZ KESSLER)
- › **Replacement** of all broken components with **new original parts**
- › **Professional removal and installation** of spindles
- › Alignment and **testing for damage**

### Replacement spindle service

- › **Over 1,000 spindles in stock** around the world
- › **Minimised downtime** through the fastest delivery times
- › The **choice** is yours: a **new part** or a fully overhauled **replacement part**
- › **Up to 18 months guarantee** on new spindles, up to 9 months guarantee on replacement spindles
- › **Professional replacement** of damaged spindles
- › Alignment and **testing for damage**



**Milling spindle repairs**  
**DECKEL MAHO, Pfronten**  
An internal spindle repair area for milling machines, continuously expanded and adapted to meet the needs of our customers. Currently employs 11 staff with around 1,100 repairs and overhauls per year.



**Turning and milling spindle repairs**  
**DMG MORI SEIKI CO., LTD., Iga**  
Cutting-edge spindle repair area with 3 specially trained spindle service technicians who work exclusively on repairing and overhauling broken spindles. Approximately 400 spindles were overhauled here in 2013.

SERVICE & SPARE PARTS

## Service fact check at DMG MORI.

DMG MORI customers are right to expect a lot from our service. Anyone who builds machine tools as a premium manufacturer must also provide top service. Therefore, DMG MORI LifeCycle Services is synonymous with highly qualified employees, short response times, availability around the clock and maximum spare parts availability. Customer satisfaction is what drives us.



### On site around the world

145 national and international distribution and service centres assure proximity to our customers. Over 2,500 certified service staff around the world.



### Speed

Free 24/7 service hotline for availability around the clock. Approximately 60% of all queries are resolved over the phone.



### Exclusive training expertise from the manufacturer

Over 200 highly qualified experts to train machine operators and service technicians.





**Lathe spindle repair**  
**GRAZIANO, Tortona**  
**GILDEMEISTER Italiana, Bergamo**  
 Spindle repairs for all DMG MORI turning machines produced in Italy, expertise straight from the factory floor. Around 100 repairs and overhauls per year.



**Lathe spindle repair**  
**GILDEMEISTER Drehmaschinen, Bielefeld**  
 A state-of-the-art internal spindle repair area, recently completely modernised, currently employs 5 staff with around 200 repairs and overhauls per year.



**Exclusive spindle repairs**  
**by KESSLER for DMG MORI**  
**China, USA and Russia**



Strong cooperation for maximum availability around the world. Over 100 specially trained service technicians employed.



**Turning and milling spindle repairs**  
**MORI SEIKI GmbH, Wernau**  
 Highly specialised spindle service department for MORI machines, currently employs 3 staff members with around 150 repairs and overhauls per year.



**Spare parts available immediately around the world**

7 spare parts centres around the world for 95 % spare parts availability.



**Our result: satisfied customers**

Overall satisfaction with our service: 1.9\*

\* On a scale from 1 = very satisfied to 5 = very unsatisfied

## SPARE PARTS

**DMG MORI Spare parts – Spare parts availability around the world with a local presence.**



You don't have to wait long for us: All orders are processed centrally and the spare parts are sent from the closest Spare Parts Centre. We use the joint network of all DMG MORI warehouses around the world – for the fastest shipment and delivery times.

**7 large spare parts centers for the fastest shipping and delivery times**

**1 GERMANY**

Global Parts Centre,  
Geretsried

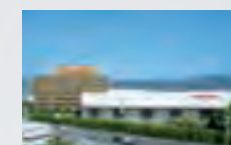
**2 JAPAN**

Global Parts Centre,  
Nara

**3 USA**

American Parts Centre,  
Dallas

**4 RUSSIA**

Russian Parts Centre,  
Moscow

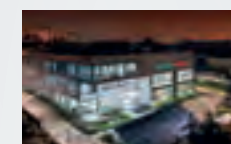
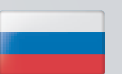
**5 INDIA**

Indian Parts Centre,  
Chennai

**6 THAILAND**

Thailand Parts Centre,  
Ayutthaya

**7 CHINA**

China Parts Centre,  
Shanghai



Only original spare parts from DMG MORI can guarantee maximum production reliability.

## HIGHLIGHTS

- \_ Global logistics network for all markets
- \_ Over € 200 million of items in stock for a spare parts availability rate of over 95 %
- \_ Over 260,000 different items in stock
- \_ Original replacement parts straight from the manufacturer
- \_ New and replacement parts available
- \_ Many spare parts also available for older machines dating back to 1970
- \_ Certified processes according to DIN ISO 9001
- \_ Ordering via the 24/7 service hotline



## MEASURING AND TESTING

## DMG MORI Microset – Manufacture more efficiently and accurately with tool pre-setting.

— Be it pre-setting, shrinking, balancing or testing and measuring – DMG MORI Microset can offer you the perfect solutions for all tool sizes and machine environments. Improve the quality and precision of your workpieces with our know-how and a wide range of products.

### External pre-setting devices – save time and money

Efficient pre-setting and measuring equipment ensures highest productivity and economy. Improved quality of provision of tools and safe and early detection of damaged tools reduces the number of reject parts and significantly increases the quality of components. Set-up during machining saves considerable amounts of time.

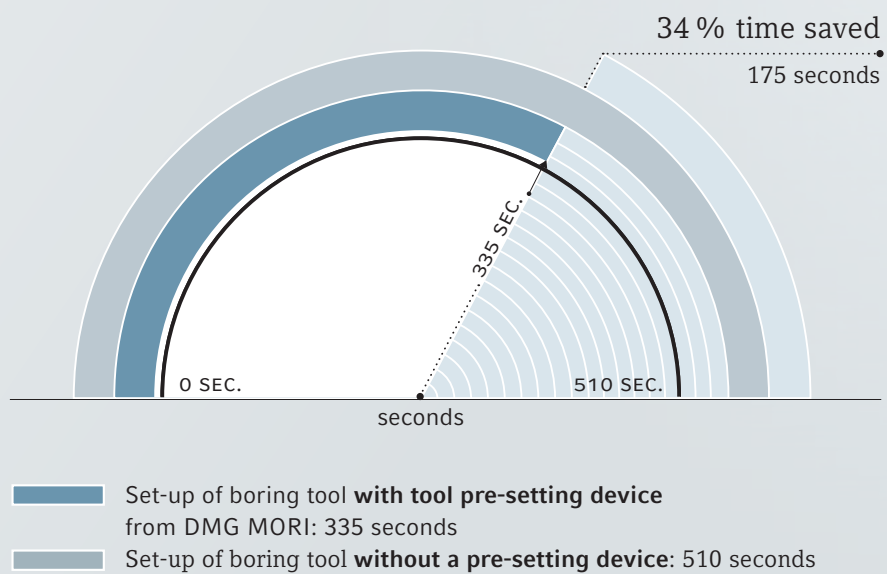

Quick and reliable  
data transfer to the  
machine.



More on the UNO  
automatic drive

**ON PAGE 11** →

## CONTACT

**Uwe Hirschenberger**  
Managing Director

DMG MORI Microset GmbH  
Gildemeisterstr. 60  
33689 Bielefeld  
Tel.: +49 (0) 52 05 / 74 44 51  
uwe.hirschenberger@dmgmori.com

## Pre-setting

- › Optimisation of set-up times
- › Reduction of machine idle times
- › Extension of tool service lives
- › Optimisation of process costs
- › Guarantee of product quality
- › Improvement of process reliability

## Finishing

- › Quick, error-free data transfer via post-processor
- › Independence from control system manufacturers
- › Extension of tool service life

## TRAINING

## DMG MORI Academy: Training expertise built up around the world from a single source.

— The **DMG MORI Academy** is the top choice when it comes to **training at a world-class level**. Our customers around the world rely on **training skills straight from the manufacturer**. As the largest CNC academy in the world, the DMG MORI Academy trains not only our own service technicians in operating, programming and preventative maintenance, but also our customers. We can pass on our knowledge to you – book your course today!

- › **11 training centres worldwide**, NEW – Wernau (DE) and Uljanovsk (RU) under construction
- › Over 200 highly qualified training experts around the world to train machine operators and service technicians
- › **50 training machines** worth over € 14 million
- › 50 classrooms with over 300 PCs and programming stations
- › **Service training** for maximum production safety



Tailored training concepts are at the heart of the DMG MORI Academy.



Quality control  
of the finished part.



DMG MORI Equator 300

## Examining

- › Close-to-the-process inspection of all workpieces directly in production
- › Flexible and customisable
- › Every inspection process can be recorded and archived
- › Testing and measurement regardless of temperature

## USED MACHINES

### DMG MORI Used Machines: Old for new – your old machine is worth more than you think!

We'll make you an offer you can't refuse! DMG MORI Used Machines will buy your used machine at a top price! If you decide to invest your newly earned capital straight into a more powerful DMG MORI machine, we will be happy to take your old machine in part payment.

#### Your benefits:

- › Quick and market-based valuation with a binding price offer
- › Quick payment and quibble-free processing
- › Professional disassembly and removal by our service team
- › Attractive financing solutions



Thomas Trump  
Managing Director

DMG MORI Used Machines  
Tel.: +49 (0) 81 71 / 8 17 – 80  
usedmachines@dmgmori.com

Let us make you  
a personalised offer  
now on

→ [www.dmgmori.com](http://www.dmgmori.com)

## Current offer!

**DMU 60 eVo linear**  
Universal milling machine  
for 5-axis machining

#### Equipment

Siemens 840D solutionline 3D control system, tool magazine with 60 stations, milling / turning package, internal coolant supply, combined tool measurement with Blum LaserControl, PP 60 infrared measuring sensor

Used machine  
Year of construction: 2012  
Machine no: 040446



APPROVED

USED MACHINE



## CNC Scout

All immediately available machines on call. Browse our online list of immediately available machines, updated daily, and find your dream machine with the right configuration at:

→ [cnc-scout.dmgmori.com](http://cnc-scout.dmgmori.com)

## SPARE PARTS ETC.

## DMG MORI Online Shop

The DMG MORI Online Shop.  
Quick to order, delivered  
immediately. Free shipping.

— You can now also order a range of products and services from DMG MORI LifeCycle Services online. The DMG MORI Online Shop offers a wide range of spare parts, software and accessories. You can now even book our spindle service and training courses online! And the best bit: Only in our new online shop can you enjoy free delivery. Every product is compiled individually by machine type. See our variety for yourself on [shop.dmgmori.com](http://shop.dmgmori.com). Under 'Offer of the month' we offer attractive products with exclusive online rewards each month. Don't miss out: take a look!

→ [shop.dmgmori.com](http://shop.dmgmori.com)

Register now and take advantage  
of attractive offers!

NEW!





## DMG PROCESS CHAIN

From the idea to the finished workpiece.



### IDEA SIEMENS NX CAD

The new workpiece is already sketched on paper and can now be modelled in the Siemens NX CAD environment with full scalability. Thanks to the latest CAD technology, you can take advantage of extremely fast model preparation.



### PROGRAMMING SIEMENS NX CAM

NX CAM supports all the machining strategies of your DMG MORI machine, both in turning and milling. The output of programs by certified post-processors guarantees the feasibility of the NC paths.



### 1:1 SIMULATION DMG VIRTUAL MACHINE

After automatically loading the NC programs and all relevant resources from NX into DMG Virtual Machine, a unique 1:1 machine simulation can be carried out thanks to the full integration of the control system and the exact depiction of the machine geometry and kinematics. Collisions and program errors are detected immediately.



### PRODUCTION DMG MORI MACHINE TOOLS

Now nothing can prevent you from realising your idea on a DMG MORI machine. Manufacture your workpieces on your DMG MORI machine 100% free from collisions. Even more economical, reliable and fast thanks to Siemens and DMG MORI!

## Software customer story



DMG process chain in the Centre for Solar Energy and Hydrogen Research: The NC programs required for production are generated with Siemens NX CAM and their feasibility is tested on the PC with DMG Virtual Machine.



Ever since the Centre for Solar Energy and Hydrogen Research started working with a DMU 60 monoBLOCK®, simultaneous 5-axis machining has also been part of the production technologies used.



The end plates ensure that the fuel cell stacks are packed across the entire surface consistently under a precisely defined level of contact pressure.

## CENTRE FOR SOLAR ENERGY AND HYDROGEN RESEARCH – Producing fuel cell stacks the smart way with the DMG process chain.

— The Centre for Solar Energy and Hydrogen Research in Baden-Wuerttemberg (ZSW) mills complex components for fuel cells on a DMU 60 monoBLOCK®. These include end plates which hold a full fuel cell stack together. 'Complex geometries are typical of end plates in order that we achieve an absolutely consistent level of compression across the entire surface', says Frank Häußler, Assistant Manager of the Fuel Cell Stacks department. The NC programs are generated using the powerful Siemens NX 3D CAD / CAM systems of the DMG process chain. The feasibility and collision-free status of these programs are then tested by researchers at the ZSW in a 1:1 simulation in DMG Virtual Machine.

— The DMG process chain has already won over the workshop supervisor Georg Zettisch: 'Especially in terms of process reliability we have gained enormous ground as there is practically no more flying blind on the machine.'

In the computer simulation, potential collisions can be identified immediately and corrected in the program. He is also able to check the fundamental feasibility of a cycle in advance, such as when a workpiece protrudes slightly over the edge of the table: 'On the machine I had estimated that the working area was large enough. However, the virtual machine showed me that the cover of the tool change system would hit the part.' Here, the machine-specific PLC of the control system integrated into DMG Virtual Machine prevented a serious collision. Georg Zettisch is now an advocate of the DMG process chain: 'In the same way that we generate highly accurate results by simulating our fuel cells in advance, the virtual machine on the PC shows us whether or not the machining process will lead to the desired result. Additionally, thanks to the powerful CAD / CAM system we are able to design and produce geometries that used to be unthinkable.'



## JOB PREPARATION

## MORI MfgSuite

### Simple programming



#### HIGHLIGHTS

- \_ Exact machine models are made available by MORI SEIKI and allow for fully reliable machine configuration
- \_ Complete integration of the MAPPS parameters
- \_ Virtual machine environment as for the real machine
- \_ Full compatibility with MAPPS / MORI-AP tool data

## MORI MfgSuite post-processor

### Hassle-free program output

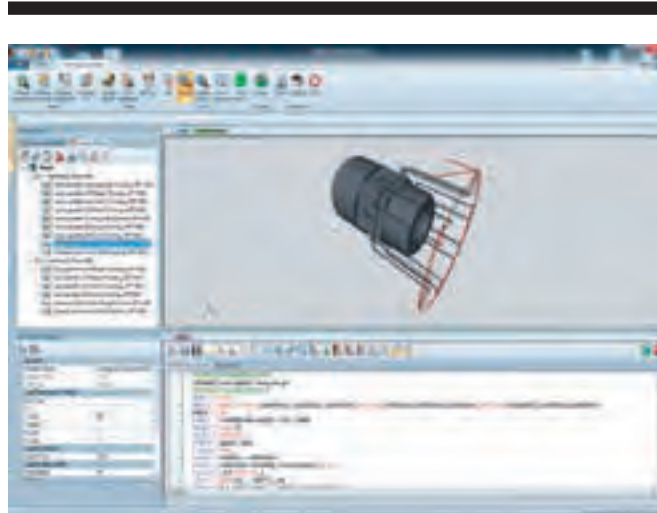

#### HIGHLIGHTS

- \_ Universal MORI-APT-CL format, which can be transferred to different MORI SEIKI machines
- \_ Integration of the tested standard template for every MORI SEIKI machine
- \_ Adaptable post-processor, which can be tailored to the specific NC program version of the customer

## MORI MfgSuite NC simulation

### Powerful machine simulation



#### HIGHLIGHTS

- \_ MORI MfgSuite is Windows software which carries out process simulations with powerful and highly precise collision monitoring
- \_ Exact models of MORI SEIKI machine tools are supplied as standard for easy configuration
- \_ Hassle-free use of the MAPPS parameters

## JOB MONITORING

## DMG MORI Messenger – Keeping you informed of what is happening in your production!



Reduced idle times – increased productivity: The new DMG / MORI SEIKI Messenger allows you to access detailed machine status information live – wherever and whenever you want. Thanks to permanent on-line monitoring you can always keep an eye on your production and thereby reduce down-times significantly.

#### Your benefits:

- › Clear machine status monitoring
- › Evaluation of machine running time, idle time and stoppages

» I can now see everything that is currently running and am able to gauge my machine use perfectly. «



## JOB MONITORING

## DMG Service Agent – High availability thanks to punctual maintenance!



DMG Service Agent is an intelligent maintenance system aimed at increasing the availability of your DMG machines. The DMG Service Agent informs you about necessary maintenance in due time and provides support. The actual machine running time is automatically read from the PLC and is recorded. You plan the execution of your maintenance work, based on this data.

#### Your benefits:

- › Automatic activation of due service and maintenance work
- › Advance notice of replacement of worn parts

» My maintenance work has finally become proactive instead of being reactive. «





DMG MORI 15 / 30

# Do the same as DMG MORI and save a large part of your energy costs!

## 'By 2015, DMG MORI will save over € 1.5 million in energy costs' Follow our example!

— Thanks to our energy efficiency programme DMG MORI 15–30, we will have lowered our energy costs across the group by up to 30% by 2015. Projects have already been implemented at eight locations – a milestone on the road to an energy-efficient MDAX publicly listed group.

— A central element is the GILDEMEISTER energy monitor, energy monitoring software designed to monitor and optimise energy consumption for industry. The GILDEMEISTER energy monitor generates detailed energy consumption analyses, clear load curve overviews and structured management reports. This ensures that energy efficiency within the company is continuously monitored and optimised.



### GILDEMEISTER ENERGY MONITOR



Detailed power consumption analysis

Load curve analysis

Compact management overview

## GILDEMEISTER energy solutions

### DMG MORI ENERGY TARGETS 2015 BY LOCATION

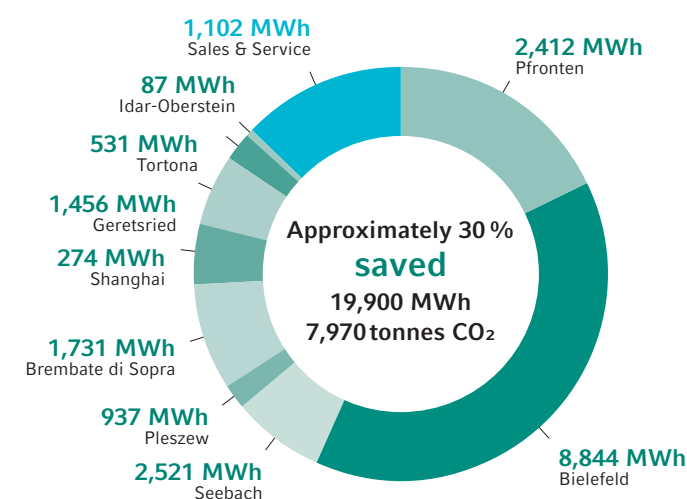

### Total savings

	2012	2015	Savings
Energy consumption:	82,600 MWh	62,700 MWh	-19,900 MWh
Total emissions:	33,230t CO <sub>2</sub>	25,250t CO <sub>2</sub>	-7,970t CO <sub>2</sub>

### HIGHLIGHTS

- \_ Around 15% of energy costs saved by the introduction of the GILDEMEISTER energy monitor
- \_ Detailed usage analysis
- \_ Energy reports at the click of a mouse
- \_ Cost centre allocation
- \_ Easy to integrate into existing energy systems

GILDEMEISTER energy solutions  
Tel.: +49 (0) 931 250 64-120  
energysolutions@gildemeister.com  
[www.energy.gildemeister.com](http://www.energy.gildemeister.com)

### DMG MORI SEIKI Europe AG

Lagerstrasse 14, CH-8600 Dübendorf

Tel.: +41 (0) 44 / 8 01 12 - 40, Fax: +41 (0) 44 / 8 01 12 - 31

info@dmgmori.com, [www.dmgmori.com](http://www.dmgmori.com)

# DMG MORI