

Test Results of Cook Stove Performance

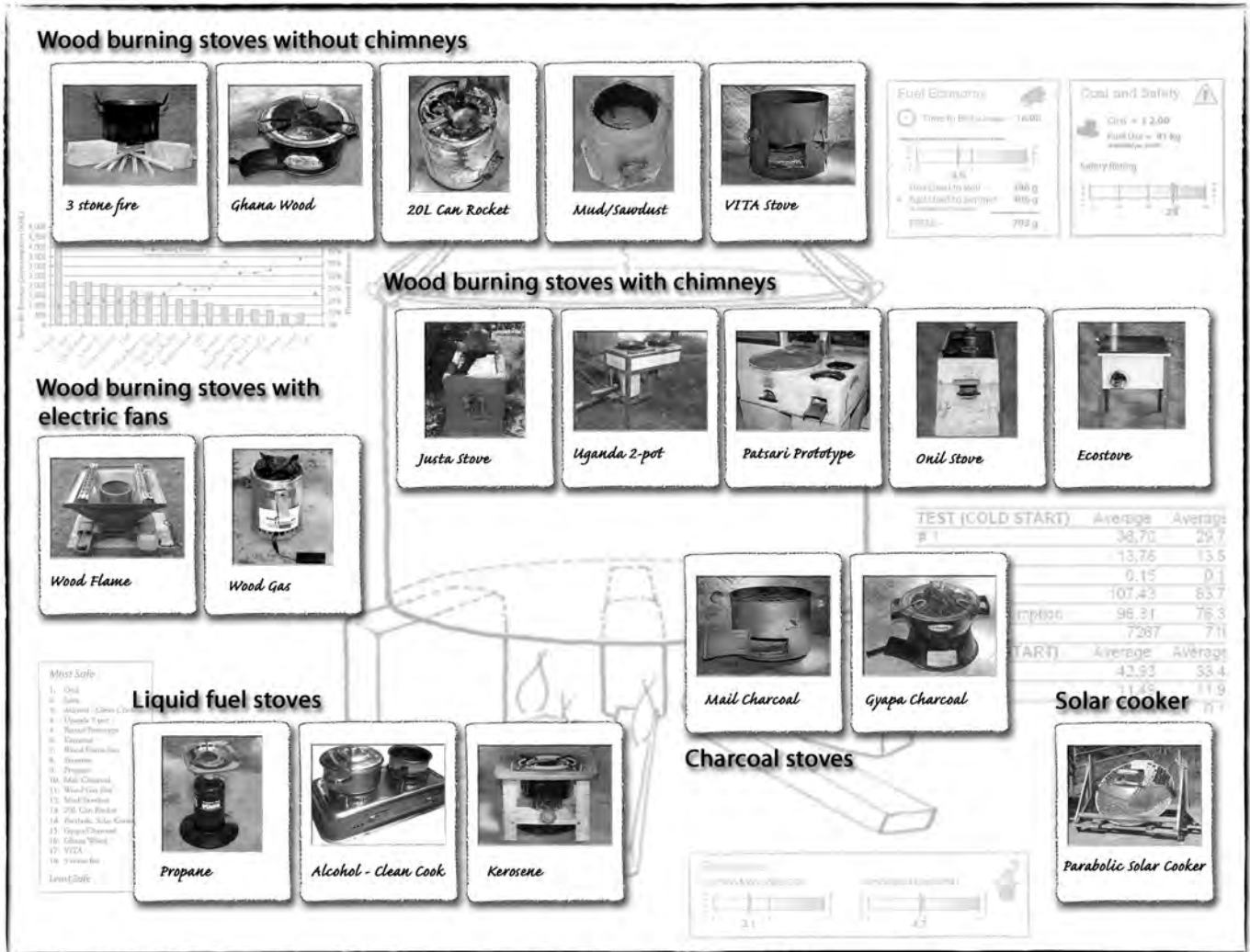

The Partnership for Clean Indoor Air was launched by the U.S. Environmental Protection Agency (EPA) and other leading partners at the World Summit on Sustainable Development in Johannesburg in September 2002. Its mission is to improve health, livelihood and quality of life in developing countries by reducing people's exposure to indoor air pollution from household energy use. More than 460 organizations are working together to increase the use of clean, reliable, affordable, efficient and safe home cooking and heating practices. For more information, or to join the Partnership, visit www.PCIAonline.org.

This document was developed by Aprovecho Research Center under a grant from the Shell Foundation to provide technical support to household energy and health projects and to ensure that the projects' designs represent the best available technical practices. The emissions testing equipment used to evaluate the stoves in this book was provided by a generous grant from the M.J. Murdock Charitable Trust. Additional financial support was provided by The Woodard Family Trust Foundation. The principal authors of this publication are Dean Still, Nordica MacCarty, Damon Ogle, Dr. Tami Bond and Dr. Mark Bryden. The participation of Dr. Bond and graduate student Christoph Roden was made possible by the U.S. National Science Foundation and the University of Illinois. The journal article "Fuel use and emissions performance of fifty cooking stoves in the laboratory and related benchmarks"¹ adds to Aprovecho's survey of household stove performance.

Aprovecho is a center for research, experimentation and education on alternative technologies that are ecologically sustainable and culturally responsive. The Advanced Studies in Appropriate Technology Laboratory at Aprovecho works to develop energy-efficient, nonpolluting, renewable technologies that reflect current research and can be made in almost any country. For more information on Aprovecho, visit www.Aprovecho.org.

¹ MacCarty, N., Still, D., and Ogle, D. (2010). Fuel use and emissions performance of fifty cooking stoves in the laboratory and related benchmarks. *Energy for Sustainable Development* 14. 161-171.

Layout and Design: Jeremy Roth

Illustrations: Stephanie Korschun

Photos: Bill Loud

Preface

Cooking fires and cook stoves are some of the earliest technologies. Therefore, it is often assumed that we thoroughly understand cook stoves and there is little improvement to be made in cook stove design. Yet we continue to learn about how to build cook stoves. There are no internationally accepted design standards for stoves burning biomass.

Users of this guide are encouraged to think of it not as the final answer, but as a step in a journey towards better, safer and more functional cooking systems. We encourage them to contribute ideas, thoughts and experiences at any of the many forums for sharing experiences with stoves, including Internet-based lists, websites, and conferences.

We hope that our work with stoves is helping to develop a model for how technology can be improved and implemented in a way that can change people's lives.

Household technologies are essential. By thinking beyond stoves we can have an even greater impact on the world around us. We can and we will change the world in the same way that we are changing stoves, by investigating what works in the lab and what works in the kitchen.

Test Results of Cook Stove Performance

Contents

Introduction	7
Reducing fuel use and lowering emissions	8
Learning from the 3 Stone Fire	8
Testing cook stoves	8
The 3 Stone Fire in the laboratory and in the field.....	9
Many good stoves	10
Improving stoves	10
Chapter 1 - Stove Descriptions and Performance	11
Wood-burning stoves without chimneys	14
3 Stone Fire	14
Ghana Wood.....	16
20 L Can Rocket.....	18
Mud/Sawdust Stove	20
VITA Stove	22
Wood-burning stoves with chimneys	24
Justa Stove.....	24
Uganda 2-pot	26
Patsari Prototype	28
Onil Stove	30
Ecostove.....	32
Wood-burning stoves with electric fans	34
Wood Flame.....	34
Wood Gas	36
Charcoal burning stoves	38
Mali Charcoal.....	38
Gyapa Charcoal.....	40
Liquid fuel stoves	42
Propane	42
Alcohol - Clean Cook Prototype.....	44
Kerosene.....	46

Contents

Solar stove	48
Parabolic Solar Cooker.....	48
Chapter 2 - Stove Rankings	50
Time to Boil.....	51
Fuel to Cook	52
Energy to Cook.....	53
Carbon Monoxide Emissions	54
Particulate Matter Emissions.....	55
Safety Ratings	56
Cost to Purchase.....	57
Monthly Fuel Use.....	58
Chapter 3 - Learning From Improved Cook Stoves	59
Why do some wood-burning stoves boil water faster?.....	59
Why do some wood stoves use less fuel?	61
Why do some stoves emit less carbon monoxide?.....	62
Which wood-burning stoves produce less particulate matter?.....	63
What was the average firepower and turn-down ratio?	64
What is the effect of adding a chimney to a wood-burning cook stove?.....	66
How does ventilation affect pollution in a kitchen?	68
How do fans improve wood-burning cook stoves?	71
How do wood- and charcoal-burning stoves compare?.....	72
How does a retained heat cooker help when cooking?	74
What is efficiency?.....	76
Does increasing heat transfer efficiency have to decrease combustion efficiency?.....	78
Does CO predict PM?	80
How do hydrocarbon emissions compare?.....	82
How does emission testing with a hood or in a test kitchen compare?.....	83
What is an “improved” cook stove?	85
How can wood-burning cook stoves be improved?	88
Appendices	91
Appendix A: Glossary	91
Appendix B: Testing Methods	93
Appendix C: Testing Data	97

Introduction

More than half of the world's population cook their food and heat their homes by burning coal and biomass, including wood, dung, and crop residues, over open fires or in rudimentary stoves. Besides releasing greenhouse gases into the air, indoor burning of these solid fuels releases dangerous particulate matter (PM), carbon monoxide (CO), and other toxic pollutants and leads to indoor air pollution levels that are often 20 to 100 times great than the air quality guidelines of the World Health Organization (WHO). Unfortunately, the health risks and threats to the environment are on the rise: the International Energy Agency estimates that 200 million more people will use these fuels by 2030.

Exposure to smoke is associated with chronic obstructive lung diseases and acute lower respiratory infections. WHO estimates that about 1.6 million people die prematurely each year due to breathing smoke. Although breathing CO is dangerous, especially for pregnant women, the elderly, and people with heart or respiratory disease, PM is probably the single most important health-related risk in breathing wood smoke.²

Breathing in even small amounts of PM can lead to increased mortality. The increase in rates of mortality caused by inhaling very high levels of PM has yet to be determined. However, a national study in the U.S. concluded that there is a 0.5 percent increase in the relative rate of death from all causes for each increase in the PM₁₀ (particles up to 10 micrometers in diameter) level of 10 µg per cubic meter. The estimated increase in the relative rate of death from cardiovascular and respiratory causes was 0.68 percent for each increase in the PM₁₀ level of 10 µg per cubic meter.³

In 2002, the World Summit on Sustainable Development identified the inhalation of smoke as a major health hazard in countries where solid fuel is

used for cooking, heating and illumination. Their resolution to reduce indoor air pollution has focused greater attention on the clean combustion of biomass fuels. Researchers have realized that both improved fuel efficiency and cleaner combustion can be achieved in improved cooking stoves.

The goal of reducing indoor air pollution is met by many interventions (increasing kitchen ventilation, using a chimney, etc.) that protect the health of a family. Cleaner burning stoves have many other benefits beyond improving health including time savings, cleaner kitchens, reduced effort to gather fuel and more sustainable use of a diminished energy resource. Stoves that use less wood and make less smoke are the result of the efforts of hundreds of people who have developed solutions over the years.

Over the past 30 years, awareness of the environmental and social costs of using traditional fuels and stoves has grown, as has understanding about how to reduce emissions from these stoves. Yet the improved stoves currently available do not always represent best practice or an understanding of design based on modern engineering. The authors of this guide intend to provide all stakeholders—people with an interest in stove design and dissemination—with information about certain consequences of their stove choices.

The challenge of cook stove design is that it is not only a technical issue, but also a human issue. How and what we cook is tightly coupled to our culture, lifestyle and resources. Cook stoves are used extensively and continually. They need to be able to boil water quickly, simmer food, and cook an almost infinite variety of foods in different ways depending on the culture. Cook stoves need to be easy to use, require little attention and respond quickly when needed. They need to be safe, efficient and nonpolluting. Cook stoves need to be pleasing to the eye.

² Naehler, L., Smith, K., Brauer, M., Chowdhury, Z., Simpson, C., Koenig, J., Lipsett, M., and Zelikoff, J. (2005). Critical review of the health effects of woodsmoke. Air Health Effects Division, Health Canada, Ottawa.

³ Samet, J., Dominici, F., Curriero, F., Coursac, I., and Zenger, S. (2000). Fine particulate air pollution and mortality in 20 U.S. cities, 1987-1994. *The New England Journal of Medicine* 2000; 343: 1742-1749.

These multiple and sometimes conflicting goals obviously require an integrated approach to cook stove design and implementation. The cook and the engineer are both “experts.”

Test Results of Cook Stove Performance represents a major step forward in developing an integrated approach to cook stove design. For the first time, a variety of stoves from across the world have been tested in a variety of ways and the results presented here for all to review. One stove is more efficient, another heats quicker, others are safer, and each of these stoves pollutes more or less than others. Stove designers can pick and choose stove design options to create stoves that serve local needs.

Reducing fuel use and lowering emissions

One of the major motivations for the “first wave” of improved stove dissemination was to reduce fuel use and thereby affect the rate of deforestation. Stoves were designed with fuel efficiency as a major goal. Improved wood-burning stoves probably saved between 30% and 50% of the fuel used to cook with the 3 Stone Fire.⁴ Unfortunately, the first-generation improved stoves were not always designed to also reduce emissions. Most early stove researchers did not have the equipment to measure harmful pollutants. In fact, researchers found that some of the fuel-efficient designs could actually increase emissions.

Reducing deforestation proved to be a difficult goal for the first wave of stove projects to achieve. Studies showed that to have an effect on deforestation, the projects would have to make fuel-efficient stoves available to a much larger percentage of the wood-using population. Even when stoves were shown to be cost effective, the need to distribute millions of stoves was daunting.

Between 1970 and 1980 many cooking stoves were developed, some were more fuel efficient than others. The thermal efficiency of stoves was

studied by researchers, and books were written that have helped create a general consensus about how to improve cooking stoves. The improved understanding of the thermodynamics of cooking with wood has been useful for the various stove-building projects around the world in their efforts to manufacture and distribute a new generation of fuel-efficient and cleaner burning stoves.

Learning from the 3 Stone Fire

As with any tool, the skill of the operator determines how well the work is accomplished. The 3 Stone Fire can be operated cleanly, or it can be very dirty and wasteful. Open fires tend to go out easily, however, and it is a natural inclination to make an overly large fire or leave smoking wood under a simmering pot while attending to other work. The fact that the 3 Stone Fire can be operated with very different results was confusing to early investigators.

In some kitchens, large fires made for cooking use a lot of wood and make a great deal of smoke. Small fires are also made that cook food relatively cleanly. Watching indigenous experts in the field cook with fire has led to a better understanding of effective biomass fuel use. Cooks who are trying to conserve wood tend to meter fuel by pushing wood into the fire, slowly burning the wood at the tip of the stick. Knowledgeable cooks only need a small, hot fire close to the pot to quickly boil water. Improving upon a well-made 3 Stone Fire was more difficult than the first generation of designers had expected. Learning from expert users helped teach engineers how to make better stoves.

Testing cook stoves

The emission collection system provides real-time data, is relatively inexpensive and has been used by other researchers. (See page 94 for emission hood details.)

The research staff at Aprovecho decided that it would be valuable to test a variety of cooking stoves from around the world. The intention was

⁴ Appropriate Technology Sourcebook, 1997.

to provide all stakeholders with information about how to make the best stove choice.

Eighteen stoves were tested in three ways:

1. Boiling 5 liters (L) of water in a standard 7-liter pot (cold and hot start), simmering the hot water for 45 minutes and carefully weighing the water remaining and the wood used for high power (bringing to boil) and low power (simmering) stove operation. The revised University of California Berkeley (UCB) Water Boiling Test (WBT) protocols were used (three repetitions per stove). The revised UCB/WBT protocols can be found in Appendix C and at www.aprovecho.org.
2. The stoves were tested three times again, using the revised UCB Water Boiling Test under the emissions hood, which measures the levels of CO, carbon dioxide (CO₂), PM and hydrocarbons. The data are displayed as they are being measured in real time. Due to technical problems, data from only one of the three Water Boiling Tests accurately measured PM.
3. The stoves were also tested three times boiling water and then simmering the hot water for 30 minutes in a 15 m³ test kitchen with approximately three air exchanges per hour. Portable emission equipment was used to measure the levels of CO, CO₂, and PM.

Testing methods are explained in detail in Appendix B on page 93.

The results of testing are presented in this book. The following chapter describes how each stove performed at high and low power in the following categories:

- Time to boil
- Fuel used to cook
- Energy used to cook
- CO emissions
- PM emissions
- Safety ratings
- Cost to purchase
- Monthly fuel use

Chapter 2 ranks each stove on eight important performance indicators. The stoves are frequently compared to the 3 Stone Fire. These comparisons point out what modifications can reduce emissions and fuel use.

Chapter 3 of this book attempts to answer frequently asked questions, such as:

- Why do some stoves boil water faster?
- Why do some stoves use less fuel?
- Why do some stoves make less CO?
- How do wood- and charcoal-burning stoves compare?
- What is the effect of adding a chimney to the stove?
- How can stoves be improved?

The 3 Stone Fire in the laboratory and in the field

It is important to remember that in the Aprovecho lab testing the 3 Stone Fire used less wood and made less pollution than cooking fires in the field. All of the fires in these tests were carefully made using dry and uniform sticks of Douglas fir fed into the fire in a controlled way to optimize the performance of all stoves.

Well-constructed 3 Stone Fires protected from wind and tended with care scored between 20% and 30% thermal efficiency. Open fires made with moister wood and operated with less attention to the wind can score as low as 5%. The operator and the conditions of use largely determine the effectiveness of operation. Stoves must be tested with careful repetition in order to minimize variables in test results.

Because there are so many differences between laboratory and field results, it is difficult to use the results of laboratory testing to predict how stoves will perform in the real world. However, side-by-side comparisons can be used to estimate performance. An automobile that gets 40 miles per gallon on a dynamometer is more likely to use

less gas on the highway than a car that only gets 20 miles per gallon in the same test. A cooking stove that used less fuel or made less pollution in a standardized test will, one hopes, translate into reductions in the field, but only field surveys can establish the actual performance.

Many good stoves

Several types of stoves were significantly better than the 3 Stone Fire on most tests, which indicates that biomass-burning stoves can be both more fuel efficient and cleaner burning. Stoves equipped with chimneys can be used safely indoors. Adding a lightweight rocket-type combustion chamber to a stove reduces CO by approximately 75% and PM by about 50% compared to an open fire. Adding a fan to a wood-burning stove dramatically reduces emissions.

The 18 stoves covered in this book embody effective solutions that are now in use in countries around the world. Having options will enable interested people to create appropriate solutions tailored to their needs. There are various successful approaches to cooking and cooks have the opportunity to choose their favorites.

Perhaps most important to a cook is how a stove prepares his or her favorite foods. This factor can outweigh the advantages of less emissions and decreased fuel consumption. Stove choice is often based on far more subjective variables. Reducing harmful emissions and fuel use will help the cook and family, but if a stove does not please the cook, it may not be used.

Improving stoves

Engineers have been studying fire for many generations, and there is general agreement that certain modifications will improve the effectiveness of biomass fuel stoves. The following suggestions will improve intermittently fed stoves that are designed to achieve more complete initial combustion and improved heat transfer efficiency to the pot or griddle.

1. **A hotter fire burns cleaner.** Insulating around a fire helps it burn hotter. Insulation should be made from lightweight materials, because heavy materials such as sand, clay or cement placed around a fire absorbs heat that could be used for cooking.
2. **Burning too much wood at once creates smoke.** Wood burns cleanly when it is fed slowly into the fire. Wood gets hot and makes gases that can be more completely burned if the gas and air are mixed into flame.
3. **The right amount of incoming air helps the fire burn cleanly.** Increasing the velocity of the right amount of air helps the fire burn hotter and helps to improve the mixing of fuel, air and spark.
4. **A grate lifts wood above the floor of the combustion chamber.** This allows air to flow up through the fire. Air can enter the fire from underneath, which is beneficial.
5. **Insulating the path of the hot flue gases (except around the pot or griddle) delivers more heat to the cooking surface.** That is because the heat is not lost into the body of the stove.
6. **Get more heat into the pot.** Most of the inefficiency in cooking occurs because heat is not effectively transferred to the pot. Heat transfer can be increased by directing the hot gases in a narrow channel parallel to the cooking surface. Gases should be kept as hot as possible and flowing at the highest possible velocity without decreasing gas temperatures. More detailed information can be found in *Design Principles for Wood Burning Cookstoves* (EPA 402-K-05-004) available at www.PCIAonline.org/resources.
7. **Increasing the surface area of the cooking surface is helpful.** On the other hand, decreasing the surface area of exposed water in pots helps to reduce steam production.
8. **An insulated space above the fire improves the mixing of hot gases, air and flame.** This significantly reduces emissions, especially if the gas is well mixed.

Chapter 1

Stove Descriptions and Performance

Wood-burning stoves without chimneys



Wood-burning stoves with chimneys



Wood-burning stoves with electric fans



Charcoal stoves



Liquid-fuel stoves



Solar cooker



This chapter describes how the individual stoves performed in three major categories:

- Fuel Economy
- Cost and Safety
- Emissions

Included are the following:

- Description of the stoves
- Stove origins
- Specifications
- Comments on performance
- Pictures and drawings of each stove

Use the following key to understand what the various numbers and the different categories mean. More detailed information on each stove and the testing methods can be found in the appendix.

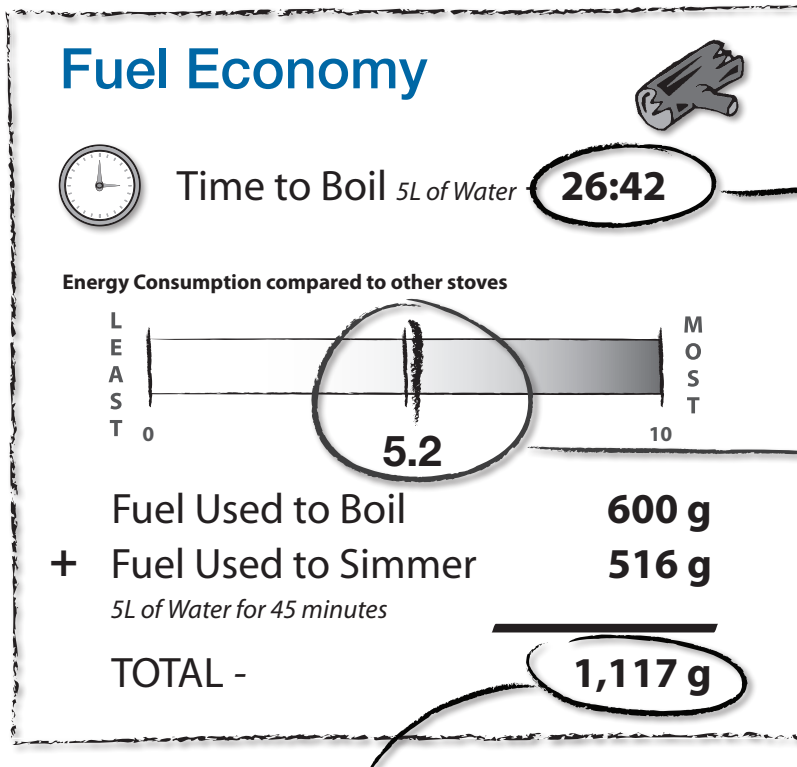

Time to Boil 5 L of water (expressed in minutes:seconds). The total time is an average of the cold and hot start phases of the Water Boiling Test.

Energy Consumption rating is how much energy is used to complete a cooking task. Different fuels can be compared on the basis of energy used. A rating of 1 would mean the stove used less energy compared to a stove that received a higher rating.

Total amount of fuel used to bring 5L of water to a rolling boil and then to simmer the water for 45 minutes. The fuel is weighed before and after each test phase to determine the amount of fuel used for each task.

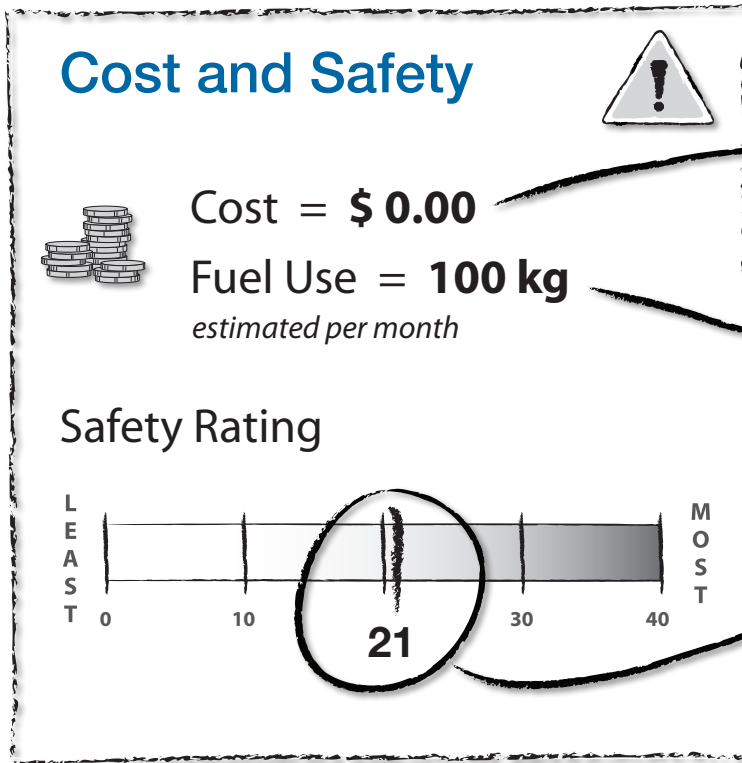

The Cost of buying or building the stove is shown in U.S. dollars.

Fuel Use is the amount of fuel used to bring 5 L of water to a rolling boil and simmer it for 45 minutes twice a day for one month (30 days). This number can be used to compare the monthly costs of operating the stoves based on local fuel costs.

The Safety Rating is determined by evaluating the stove in multiple categories such as the likelihood of tipping, burns, fire spreading and sharp edges on a scale of zero to 40 points. Appendix C includes the detailed safety evaluation methods.

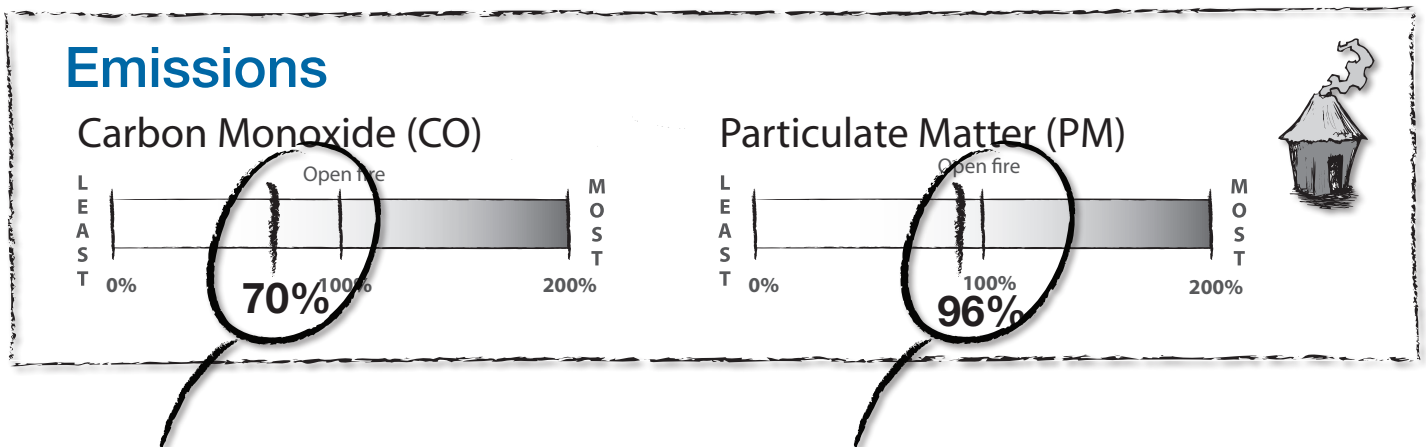

The Carbon Monoxide (CO) and Particulate Matter (PM) ratings show the average relation between stoves based on pollution-level data collected from the test kitchen. The CO and PM averages are based on three tests done in the test kitchen. Percentages were calculated relative to an open fire.

3 Stone Fire

Origin: Traditional

Weight: 5.1 kilos

Fuel Type: Wood

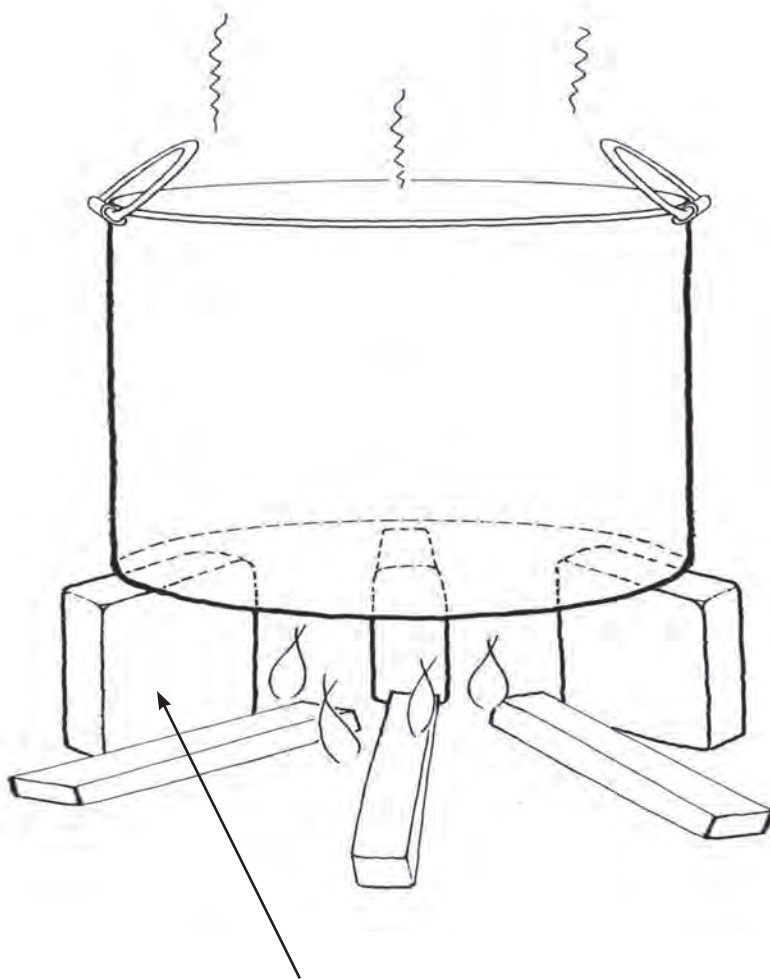
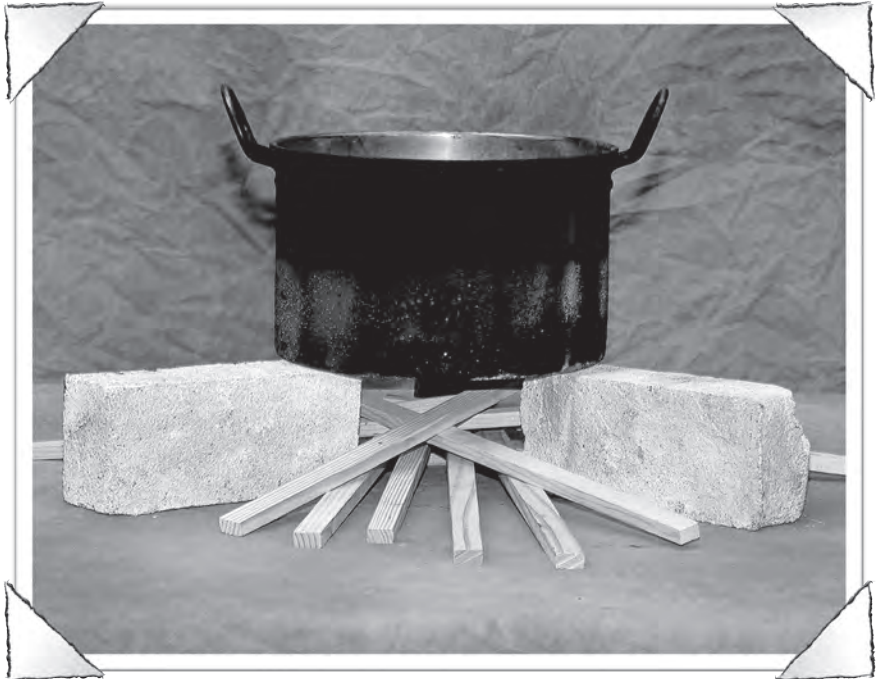

The 3 stones or bricks (20 x 6.5 x 9.5 cm) hold the pot over the flames of an open fire.

Description:

Open fires are used every day by a large percentage of the world's population. The 3 Stone Fire can be used more or less successfully, depending on the care and skill of the operator. If the sticks of wood are burnt at the tips and pushed into the center as the wood is consumed, the fire can be hot and relatively clean burning. If too much of the stick is smoldering, a lot of smoke can be made. If the pot is closer to the fire, more of the heat enters the pot.

In this case, the pot was placed 12 cm above the ground on three bricks. Dry wood was used. The fire was indoors and care was taken to make the fire as effective as possible. The 3 Stone Fires are usually made less carefully and can be expected to use more wood and make more smoke and harmful emissions than the fires in these tests.

3 Stone Fire

Performance:

It is difficult to keep the 3 Stone Fire burning. The sticks of wood are often touching the ground, and the fire can die out fairly easily. The temptation is to make a big fire, so it won't go out.

A lot of smoke was made when lighting the fire and when it wasn't burning well. When the fire was large and hot, there was less smoke.

The 3 Stone Fire was hard to start. If it had been outside in the wind, lighting the fire and cooking would have been much more difficult.



Test Results

Fuel Economy



Time to Boil 5L of Water - **26:42**

Energy Consumption compared to other stoves

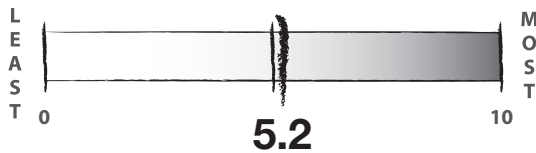

Fuel Used to Boil **601 g**

+ Fuel Used to Simmer **517 g**
5L of Water for 45 minutes

TOTAL - 1,118 g

Cost and Safety



Cost = **\$ 0.00**

Fuel Use = **67 kg**
estimated per month

Safety Rating

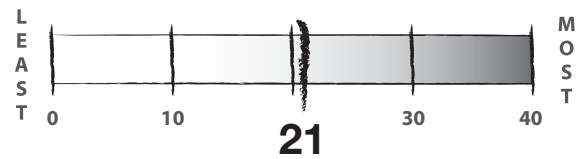

Emissions

Carbon Monoxide (CO)

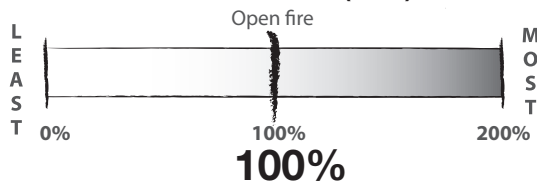

Particulate Matter (PM)

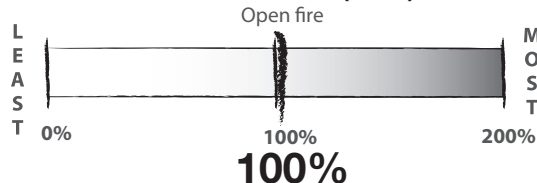

Ghana Wood

Origin: Ghana, Africa

Weight: 8 Kilos

Fuel Type: Wood

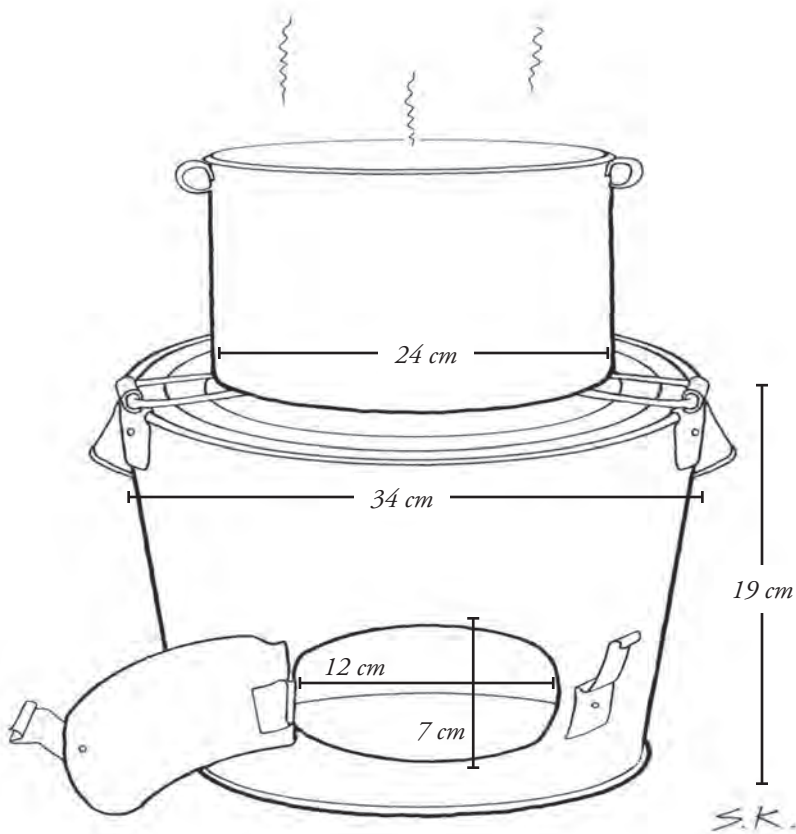

Description:

The Ghana stove surrounds the fire with a thick ceramic liner inside a sturdy sheet metal body. The pot sits on three supports about 20 cm above the stove floor. Fuel is pushed into the fire through a door that can be closed.

This is a durable and safe stove. The walls protect the fire from the wind, and the opening is large enough to freely feed the fire. Closing the door helps leftover wood simmer food efficiently.

Once the stove body is hot, the walls surrounding the fire help keep the fire from cooling. Radiant heat from the fire directly contacts the pot. Sturdy handles help the cook move the stove as needed.

Ghana Wood

Performance:

Although the Ghana stove uses slightly less fuel than the 3 Stone Fire, it pollutes more. Enclosing a fire inside a cylinder of heavy ceramic and sheet metal does not help the fire burn more cleanly. Instead, the walls may cool the fire initially and cause the fire to smoke a bit more.

On the other hand, the stove is faster to boil than the 3 Stone Fire and works better in windy conditions. As mentioned, closing the door helps conserve wood, which is very useful when simmering food.

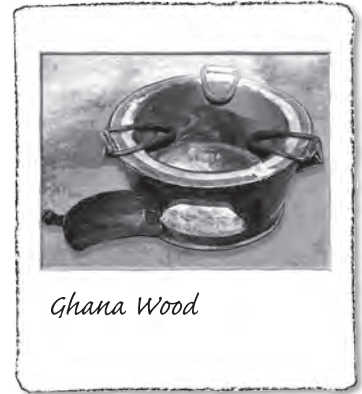

Ghana Wood

Test Results

Fuel Economy



Time to Boil 5L of Water - **21:48**

Energy Consumption compared to other stoves

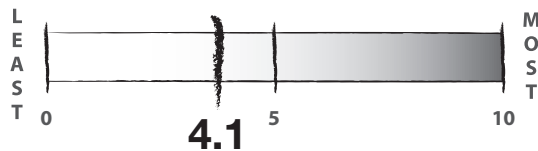

4.1

Fuel Used to Boil **422 g**

+ Fuel Used to Simmer **574 g**

5L of Water for 45 minutes

TOTAL - 996 g

Cost and Safety



Cost = **\$ 5.00**

Fuel Use = **60 kg**
estimated per month

Safety Rating

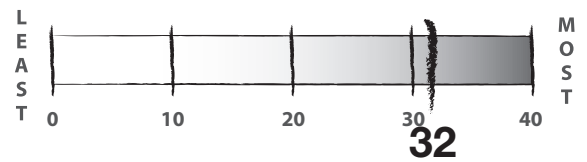

32

Emissions

Carbon Monoxide (CO)

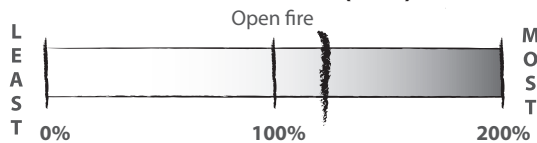

124%

Particulate Matter (PM)

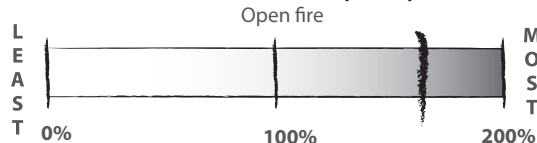

178%



20 L Can Rocket

Origin: Prototype

Weight: 6.6 kilos

Fuel Type: Wood

Contact:

Aprovecho Research Center

PO Box 1175

Cottage Grove, OR 97424

www.aprovecho.org

tel: (541) 767-0287

tel: (541) 895-5677

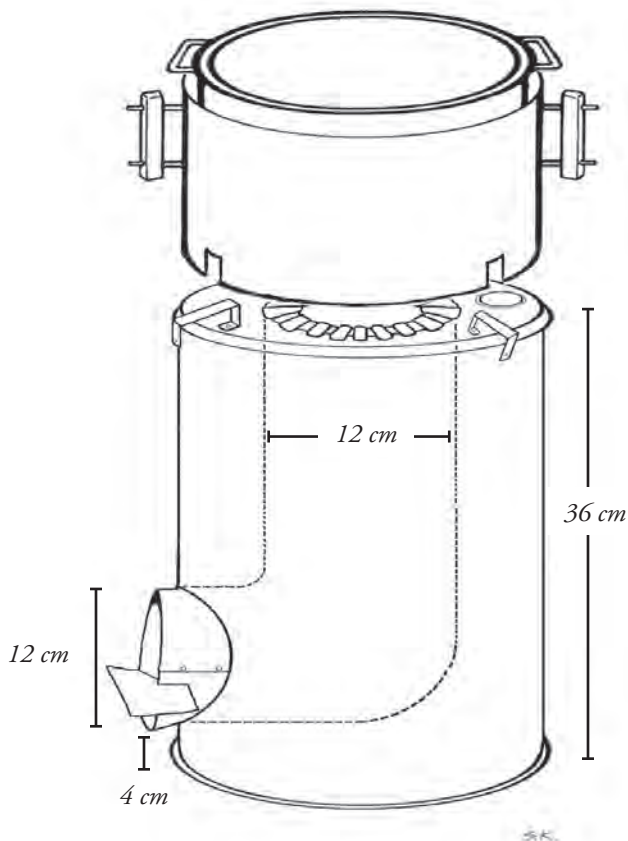

Description:

Relief agencies such as the World Food Program distribute food in 20 L metal cans all around the world. Rwandan refugees made stoves from these cans in the Mgunga camps in Tanzania.

A rocket-type combustion chamber is inserted in the can. Three supports made from folded metal hold up the pot. Wood ash fills the space inside the stove between the combustion chamber and the stove body. A metal cylinder (not shown) surrounds the pot, increasing heat transfer efficiency by forcing hot flue gasses to scrape against the pot.

The high temperatures in the combustion chamber deteriorate the metal, which has to be replaced in two to three months. Making the combustion chamber from ceramic or preferably lightweight firebrick makes this stove much longer lasting. Lightweight ceramic weighs less than 0.8 grams/cubic centimeter.

20 L Can Rocket

Performance:

The lightweight, well-insulated combustion chamber in the 20 L can stove reduces both CO and PM compared to the 3 Stone Fire. Both heat transfer and combustion efficiency are improved, which means that fuel use and emissions are reduced.

The CO produced is about one-third of that made by the 3 Stone Fire, and the PM is about half. The higher temperatures and improved mixing of flame, gases and air above the fire result in more complete combustion.

Since metal does not last at the high temperatures in the combustion chamber, it is preferable to replace it with insulative refractory ceramics when possible.



20 L Can Rocket

Test Results

Fuel Economy



Time to Boil 5L of Water - **22:18**

Energy Consumption compared to other stoves

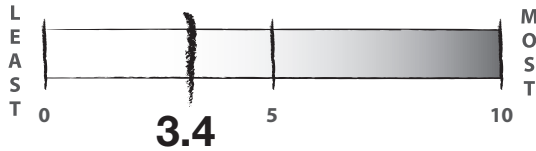

3.4

Fuel Used to Boil **361 g**

+ Fuel Used to Simmer **372 g**

5 L of Water for 45 minutes

TOTAL - 733 g

Cost and Safety



Cost = **\$ 0.00***

Fuel Use = **44 kg**
estimated per month

Safety Rating

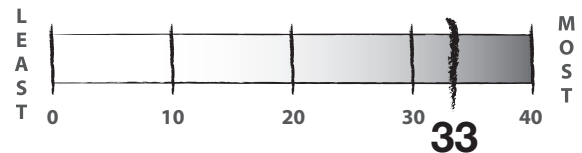

33

*When cans and sheet metal are available for free.

Emissions

Carbon Monoxide (CO)

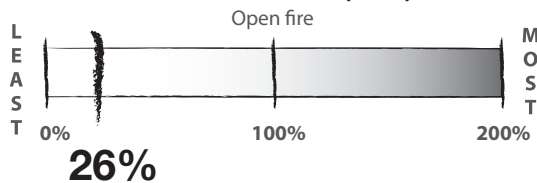

26%

Particulate Matter (PM)

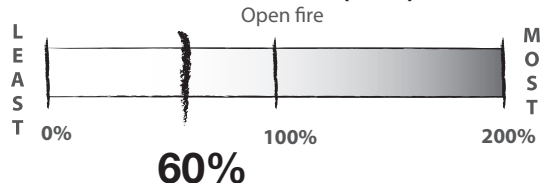

60%



Mud/Sawdust Stove

Origin: Africa

Weight: 18 kilos

Fuel Type: Wood

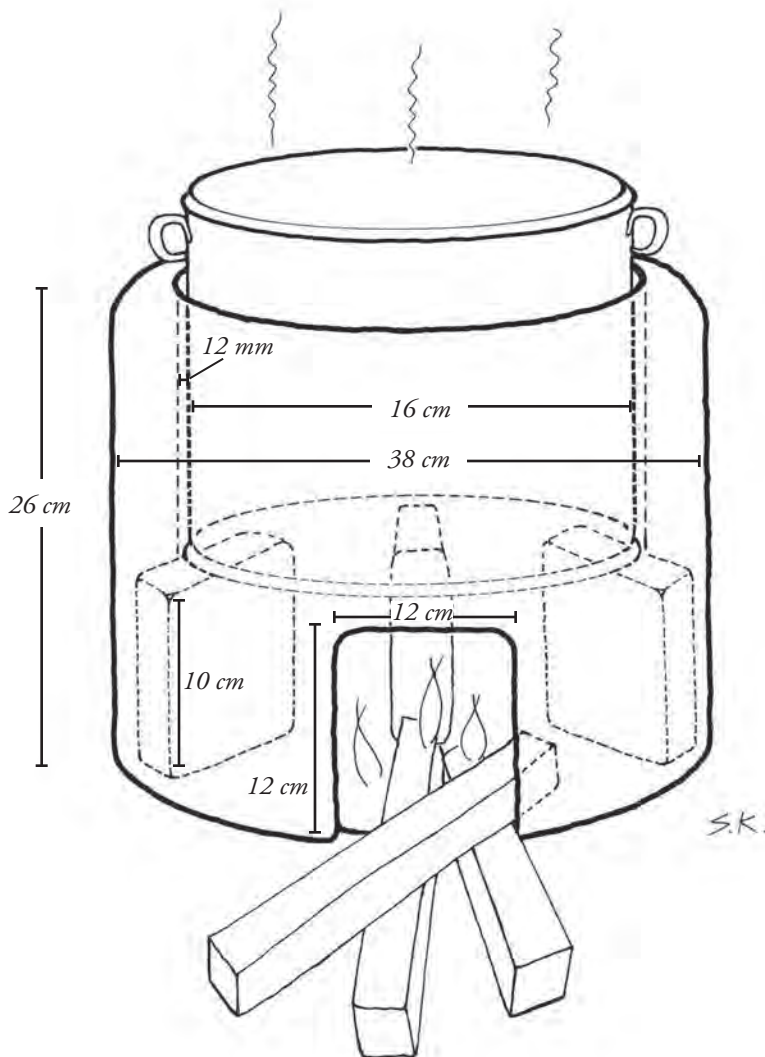
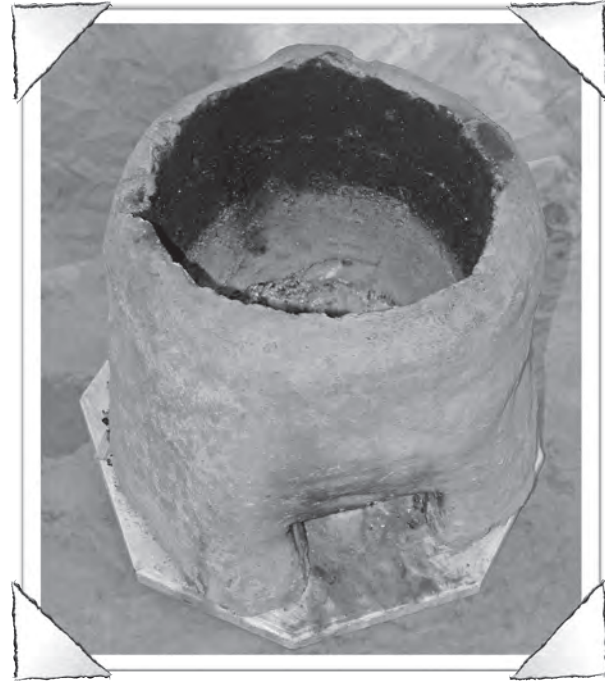

Description:

This stove is made from 60% sand and 40% clay. Then equal amounts of sawdust are added to the earthen mixture. The sawdust lightens the sand/clay material.

Eventually the sawdust nearest the inside of the wall burns away, creating small pockets of air which help to insulate the fire.

The gap between the earthen cylinder and the pot was 12mm. The small channel forces the hot flue gases to scrape against the sides of the pot after touching its bottom. The scraping of heat against the side of the pot increases heat transfer efficiency, which decreases wood use compared to the 3 Stone Fire.

Emissions are higher than an insulated stove with a combustion chamber that effectively increases the mixing of the flame and smoke. However, this type of stove can be built with found materials and provides improved fuel use and protection of the fire from wind. The stove might be suitable for refugees, especially when used in well-ventilated areas.

Mud/Sawdust Stove

Performance:

Just as with the 3 Stone Fire, it is difficult to keep the fire going in this stove. A grate under the fire would be a big help. It is tempting to make an overly large fire that will not easily die out.

The small channel is filled with flame at times, and it is easy to see why more heat enters the pot through the sides. It is nice to see that a potentially zero-cost wall of earth and sawdust can boil water faster while using less fuel than a 3 Stone Fire.

Unfortunately, the stove only works well with the pot for which it was designed.



Mud/ Sawdust Stove

Test Results

Fuel Economy



Time to Boil 5L of Water - **16:00**

Energy Consumption compared to other stoves

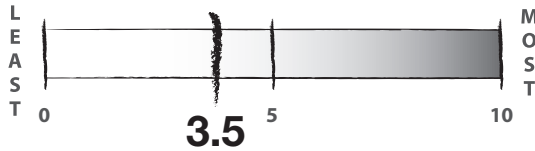

3.5

Fuel Used to Boil **386 g**

+ Fuel Used to Simmer **406 g**

5L of Water for 45 minutes

TOTAL - 793 g

Cost and Safety



Cost = **\$ 0.00**

Fuel Use = **48 kg**
estimated per month

Safety Rating

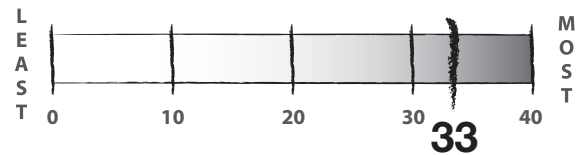

33

Emissions

Carbon Monoxide (CO)

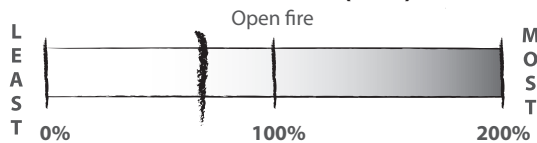

75%

Particulate Matter (PM)

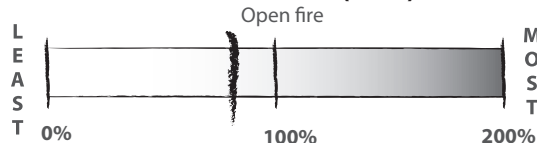

87%



VITA Stove

Origin: West Africa

Weight: 2.2 kilos

Fuel Type: Wood

Contact:

Relief International/
EnterpriseWorks-VITA

1100 H Street NW, Suite 1200
Washington, DC 20005
www.enterpriseworks.org

info@enterpriseworks.org
tel: (202) 639-8660
fax: (202) 639-8664

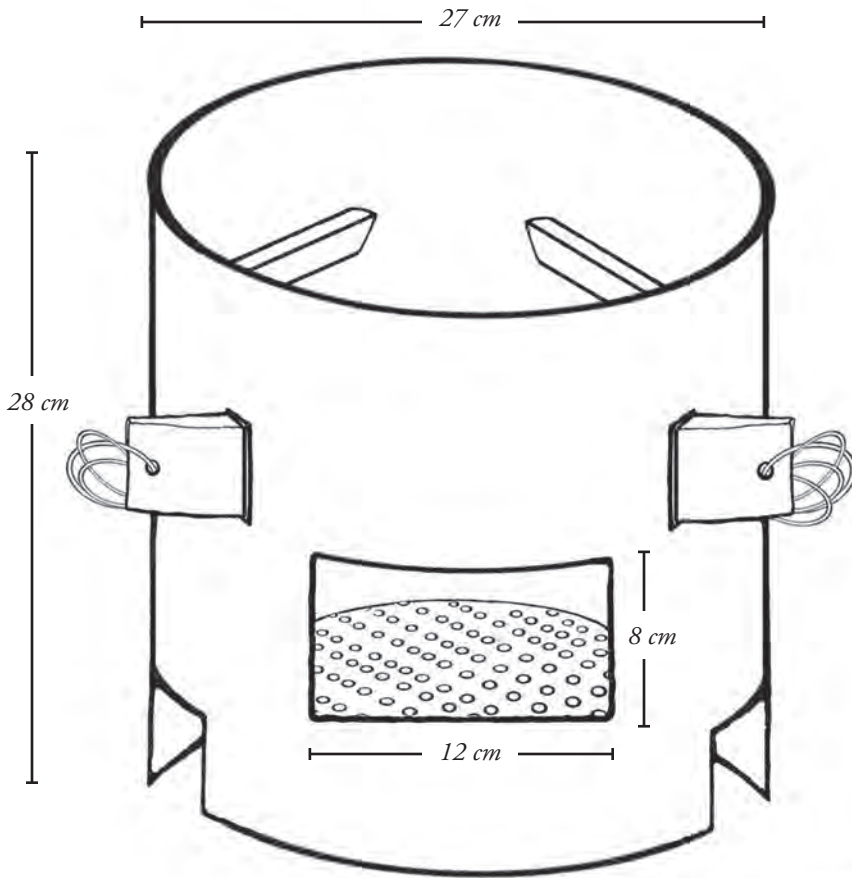
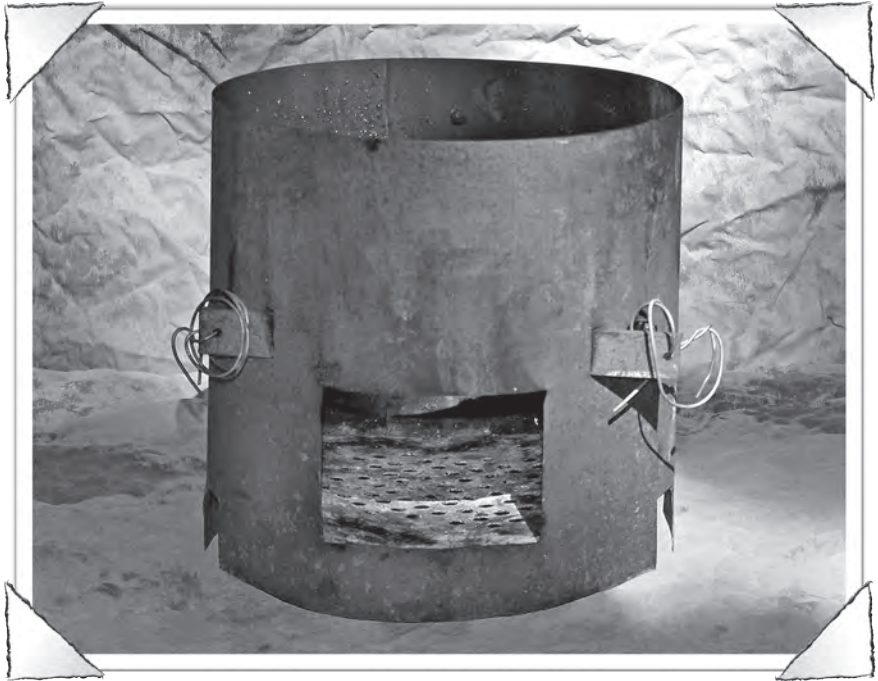

S.K.

Description:

The VITA stove was designed by Dr. Sam Baldwin. It is the result of a great deal of study to inexpensively reduce the fuel used to cook food.

Dr. Baldwin's book *Biomass Stoves: Engineering Design, Development, and Dissemination* is an important work that describes practical methods to improve heat transfer and decrease the wood used for cooking.

The VITA stove is made from sheet metal that creates an appropriately sized gap between the pot and stove body. A grate holds the wood up over the floor, allowing air to pass through the fire. The pot is held up by three sturdy supports. Plans to build the stove are included in *Biomass Stoves*.

Since the pot is contained within the cylinder of sheet metal, both it and fire are protected from the wind. The stove will work well only with the intended pot. The stove is durable, lightweight and portable.

VITA Stove

Performance:

The simple VITA stove is one of the most fuel-efficient stoves tested. The fire is close to the pot, and hot flue gases contact both the bottom and sides of the pot. It can boil water quickly.

Since the stove does not have a combustion chamber, merely an open space for the fire, and because the fire is close to the pot, emissions are rather high.

The VITA stove features ease of construction, low cost and decreased fuel use. This type of stove seems well-suited to emergencies and where cooking occurs outdoors in well-ventilated areas.



VITA Stove

Test Results

Fuel Economy



Time to Boil 5L of Water - **14:00**

Energy Consumption compared to other stoves

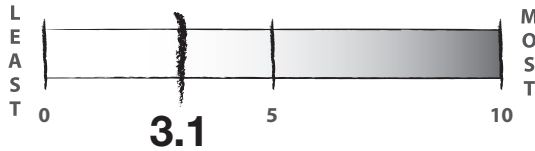

3.1

Fuel Used to Boil **352 g**

+ Fuel Used to Simmer **338 g**

5L of Water for 45 minutes

TOTAL - 689 g

Cost and Safety



Cost = **\$ 2.00**

Fuel Use = **41 kg**
estimated per month

Safety Rating

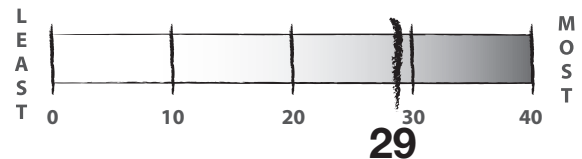

29

Emissions

Carbon Monoxide (CO)

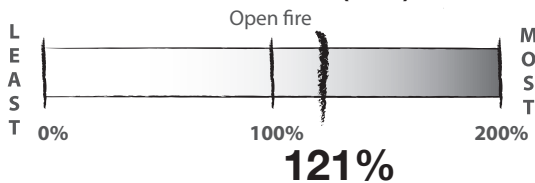

121%

Particulate Matter (PM)

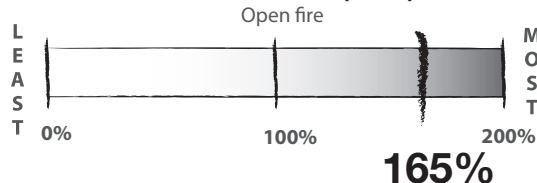

165%



Justa Stove

Origin: Central America

Weight: 175 kilos

Fuel Type: Wood

Contact:
Trees, Water & People

633 Remington Street
Fort Collins, CO 80524

twp@treeswaterpeople.org

tel: (970) 484-3678
toll free: (877) 606-4897

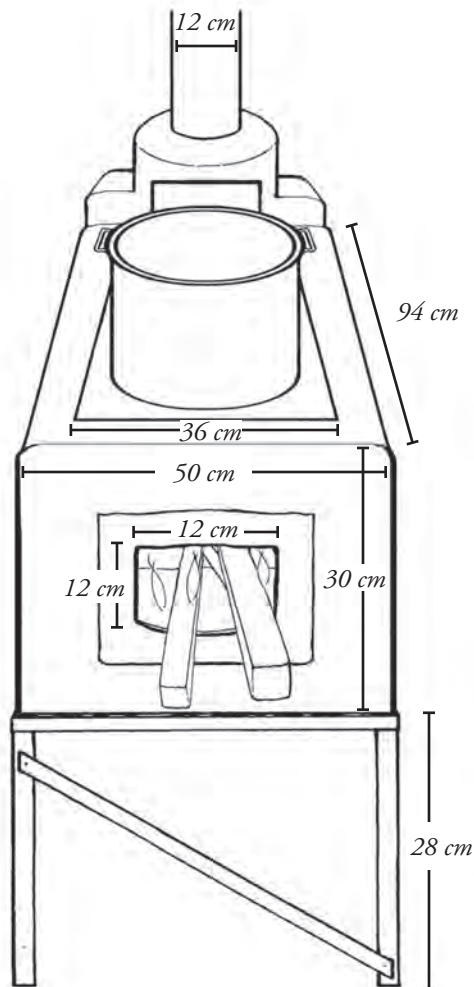

Description:

The Justa stove body is constructed from bricks enclosing a rocket-type combustion chamber. The combustion chamber is made from "baldosa," a widely available and inexpensive ceramic floor tile.

Wood ash is deposited between the combustion chamber and the stove body. The wood ash almost fills the interior leaving a 2 cm channel between the ash and the griddle. Hot flue gases flow in this space to the chimney.

A constant cross-sectional area is maintained throughout the stove from the fuel entrance, up the combustion chamber, under the griddle, to the chimney. Heat transfer is increased because the hot gases are forced to scrape against the underside of the griddle. The wood ash insulation helps to keep the gases hot, while the constant cross-sectional area of the spaces inside the stove reduce friction that would slow the gases. Heat has to pass through the griddle to the pots on top of it.

Justa Stove

Performance:

The Justa stove can heat two or three pots of food at once. It is designed for Central America, where the griddle is used for making tortillas. Since heat has to pass through the griddle to the pots of food, the stove uses more fuel than a single-pot stove to boil and simmer water.

However, the sealed stove body takes almost all pollution out of the room through the chimney. This type of stove, with a functional chimney, can solve the problem of indoor air pollution. The solid body also protects the occupants from burns.

The griddle-type stove provides the cook with many advantages: clean pots, clean kitchen, greater convenience, and potentially reduced fuel use for a variety of cooking tasks. In field tests, the Justa stove saved approximately 70% of the wood typically used for cooking.



Test Results

Fuel Economy

 Time to Boil 5L of Water - **46:42**

Energy Consumption compared to other stoves

LEAST 0 5 6.3 10 MOST

Fuel Used to Boil **662 g**
 + Fuel Used to Simmer **704 g**
5L of Water for 45 minutes

TOTAL - **1,367 g**

Cost and Safety

 Cost = **\$ 60.00**
 Fuel Use = **82 kg**
estimated per month

Safety Rating

LEAST 0 10 20 30 38 40 MOST

Emissions (in Test Kitchen)

Carbon Monoxide (CO)

Open fire

LEAST 0% 100% 200% MOST

0%

Particulate Matter (PM)

Open fire

LEAST 0% 100% 200% MOST

0%

The Justa stove and Patsari Prototype were not tested in the test kitchen since they are stationary stoves. However, like the other stoves with chimneys, they can be expected to produce close to 0.0 CO and PM because the chimney removes pollution from the room.

Uganda 2-pot

Origin: Uganda

Weight: 36 kilos

Fuel Type: Wood

Contact:
Aprovecho Research
Center

PO Box 1175
Cottage Grove, Oregon 97424

www.aprovecho.org
tel: 541 767-0287

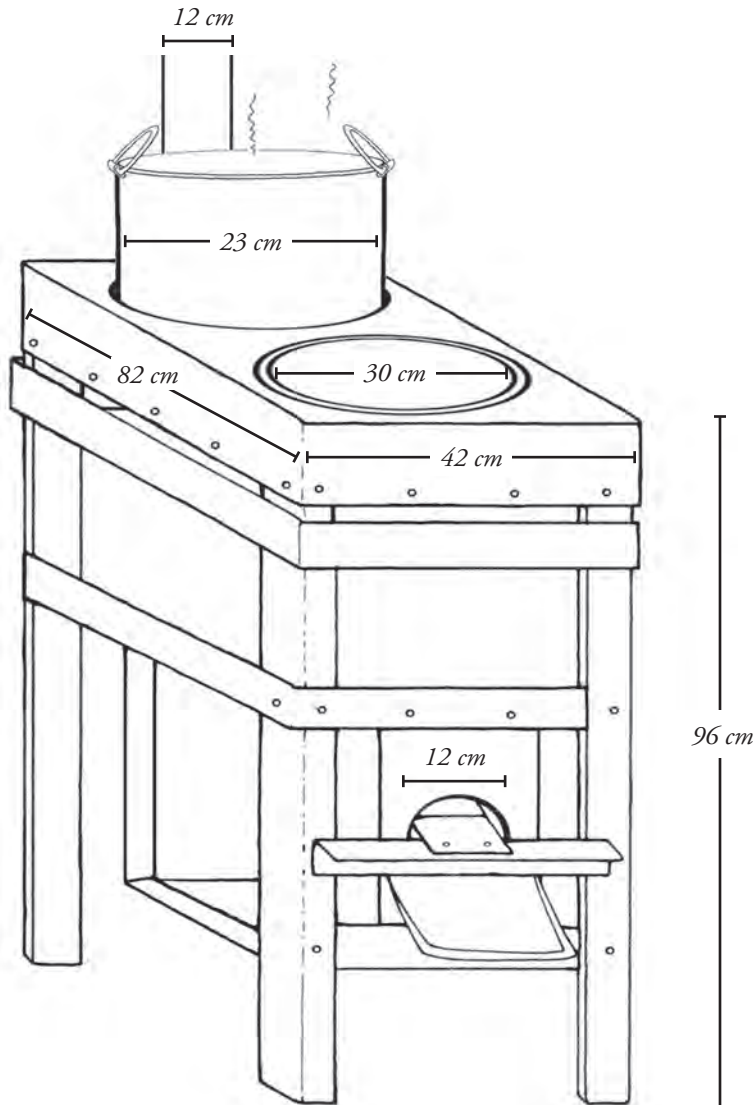

Description:

The Uganda 2-pot stove has a rocket-type combustion chamber made from lightweight insulative fire brick. The hot gases made by the fire pass through narrow, insulated channels around the first pot, which is deeply sunk into the stove. The gases then pass through an insulated tunnel and are forced into narrow channels around the second pot before exiting the chimney. The pots fit tightly into holes in the sheet metal top, preventing smoke from escaping into the kitchen.

Like the VITA and Mud/Sawdust stoves, this stove only works well with the pots that come with it. Sinking pots into cylinders that force hot gases to scrape against the sides of the pots increases efficiency and decreases wood use. However, this technique requires the use of specified pots.

Uganda 2-pot

Performance:

This stove is fast to boil and uses less wood than most stoves with chimneys. Sunken pots help to dramatically improve fuel use and time to boil in stoves with chimneys. Smoke exits the room up the chimney.

The first pot is 30 cm in diameter, which uses up most of the heat from the fire. The smaller 23 cm pot will not boil but instead is designed to simmer sauce while corn porridge is being prepared in the larger pot. For both pots to boil, the first pot needs to be smaller than 25 cm, or the firepower has to be increased.

The fire brick insulates the stove body, which does not get very hot, making this a safer stove.



Test Results

Fuel Economy



Time to Boil 5L of Water - **16:12**

Energy Consumption compared to other stoves

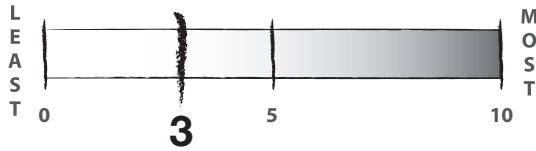

	Fuel Used to Boil	262 g
+	Fuel Used to Simmer	459 g
	<i>5L of Water for 45 minutes</i>	
	TOTAL -	720 g

Cost and Safety



Cost = **\$ 40.00**

Fuel Use = **43 kg**
estimated per month

Safety Rating

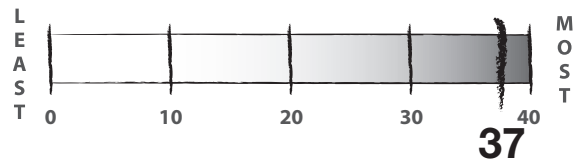

Emissions (in Test Kitchen)

Carbon Monoxide (CO)

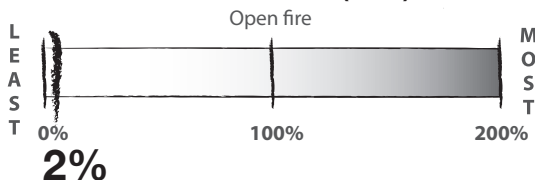

Particulate Matter (PM)

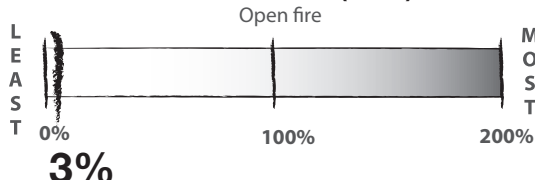

Patsari Prototype

Origin: Pátzcuaro,
Michoacán, Mexico

Weight: 280 kilos

Fuel Type: Wood

Contact: GIRA

Centro Comercial El Parián
Interior 17, Col. Morelos, A.P.
158, CP. 61609, Pátzcuaro,
Michoacán, México

giraac@gira.org.mx
Tel: (+0052) (434) 342.32.16

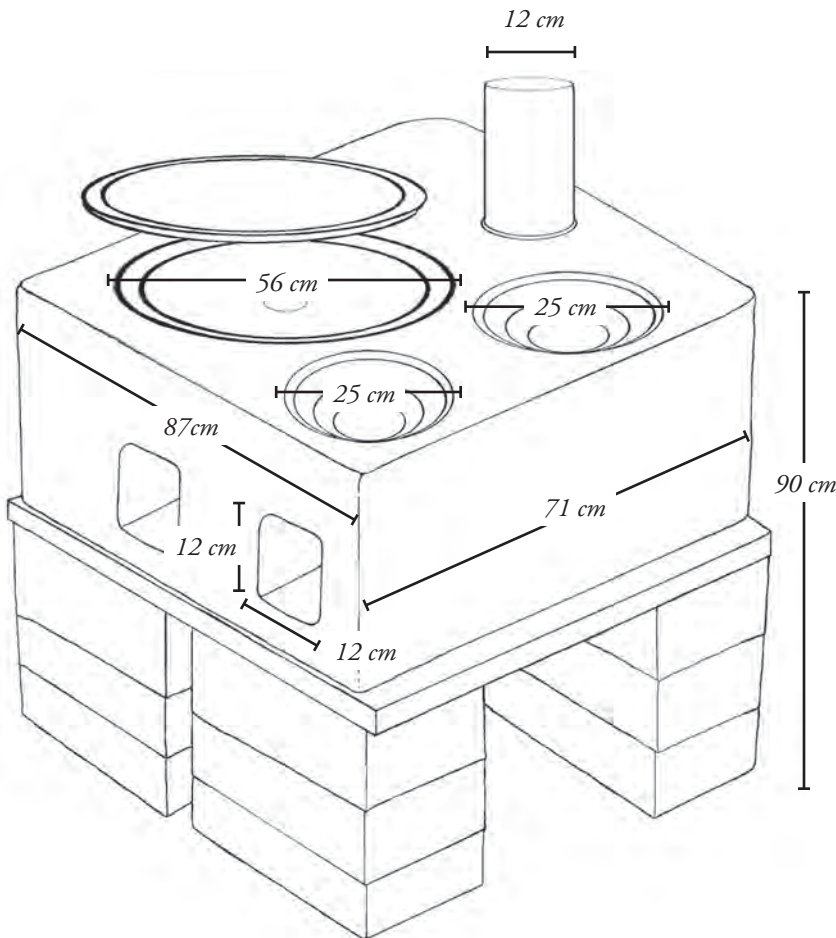

Description:

The GIRA team developed the Patsari stove with indigenous people in the high-altitude, hilly regions of Mexico. This version has two hollow cylinders of insulative brick inside the spaces under the two pots. The fire directly hits the bottoms of both pots.

A second fire inside another insulated combustion chamber is used to cook tortillas on a large circular comal or griddle.

The stove is made from a Lorena-type earthen mixture of approximately 60% sand and 40% clay. Molds are used to ensure uniformity. The lightweight ceramic insulation near the fire, with the Lorena mix surrounding it, creates a composite material which is inexpensive and beautiful.

A chimney stove made mostly from sand and clay provides a family with a clean, pleasant cooking stove that removes harmful pollution from the kitchen.

Patsari Prototype

Performance:

The stove with chimney removes essentially all of the harmful emissions from the room. The draft is sufficient to draw the smoke into the stove and up the chimney.

Since the pots in this version are directly contacted by the fire, the Patsari is more fuel efficient than other stoves with griddles.

This is a safe stove which keeps heat inside and does not overly warm the exterior.



Test Results

Fuel Economy



Time to Boil 5L of Water - **34:48**

Energy Consumption compared to other stoves

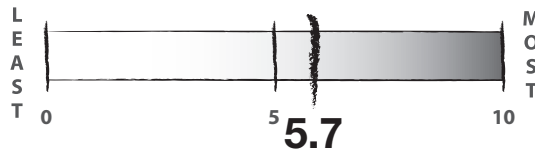

Fuel Used to Boil **558 g**

+ Fuel Used to Simmer **720 g**

5L of Water for 45 minutes

TOTAL - 1,277 g

Cost and Safety



Cost = **\$ 35.00**

Fuel Use = **77 kg**
estimated per month

Safety Rating

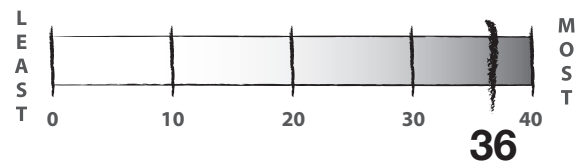

Emissions (in Test Kitchen)

Carbon Monoxide (CO)

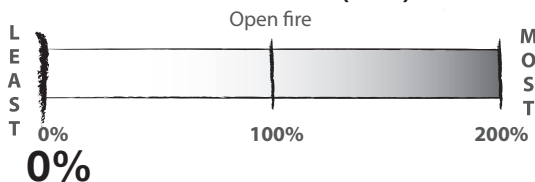

Particulate Matter (PM)

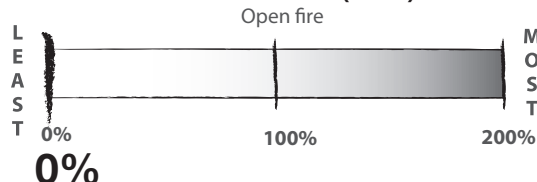

The Patsari Prototype and the Justa stoves were not tested in the test kitchen. However, like the other stoves with chimneys, they can be expected to produce close to 0.0 CO and PM because the chimney removes pollution from the room.

Onil Stove

Origin: Guatemala

Weight: 280 kilos

Fuel Type: Wood

Contact:
HELPS International

15301 Dallas Pkwy. Suite 200
Addison, TX 75001

info@helpsinternational.com

tel: (972) 386-2901
toll free: (800) 414-3577

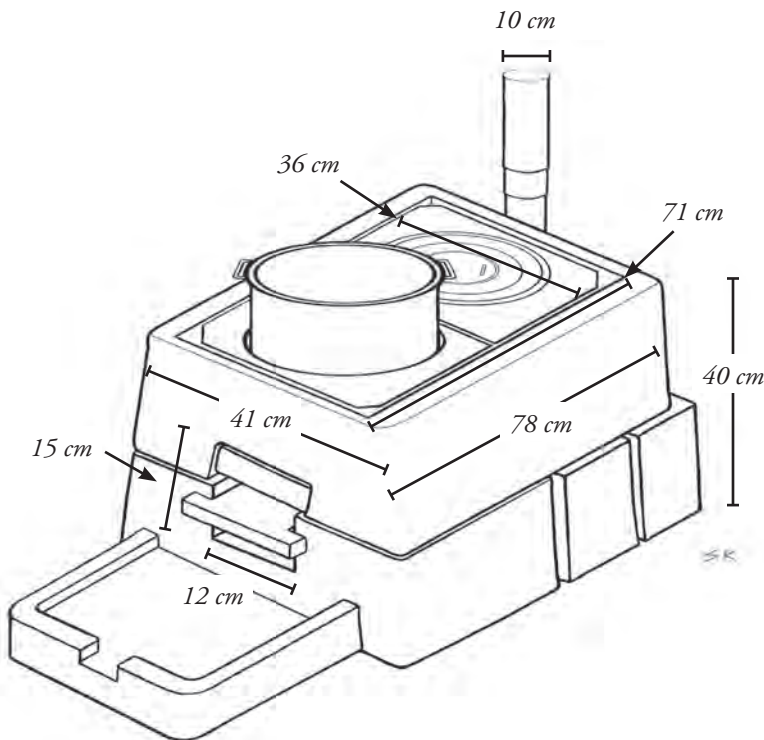
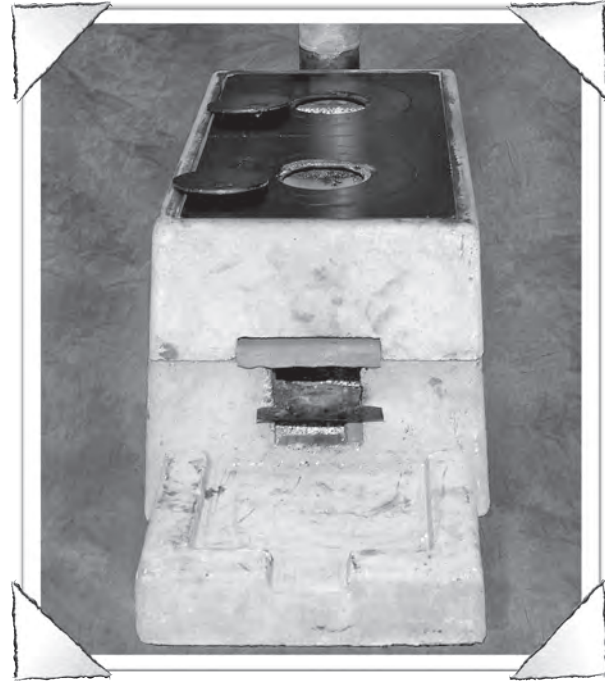

Description:

Don O'Neal developed this molded-cement griddle stove with the help of indigenous women in Guatemala. The three-part stove is made in a factory using molds.

A rocket combustion chamber made from ceramic floor tile material (molded baldosa) is surrounded by loose pumice used as insulation. The pumice fills the stove within 2 cm of the griddle, creating a wide channel that forces the hot flue gases to scrape against the underside of the griddle.

The griddle has removable inserts so flame can contact the bottom of the pots. A protected fence around the chimney (not pictured) guards the users from burns.

The Onil stove is made in a factory and looks professionally made. The molded-cement body is strong and very long lasting.

Onil Stove

Performance:

The Onil is a well-thought-out stove that can boil two pots of water exposed to flame and hot gases. The removable inserts are well made and fit large and small pots.

Fuel use is similar to the Justa. Smoke is removed from the kitchen through the functional chimney.

The Onil ranks high on safety and is a fine example of an improved griddle-type stove. Field surveys found that the Onil stove uses approximately 70% less wood than traditional cooking methods in Guatemala.



Onil Stove

Test Results

Fuel Economy



Time to Boil 5L of Water - **28:00**

Energy Consumption compared to other stoves

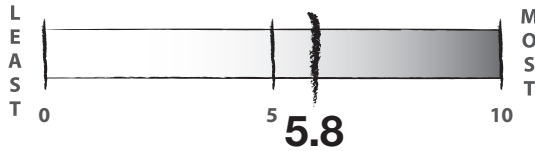

Fuel Used to Boil **584 g**

+ Fuel Used to Simmer **802 g**

5L of Water for 45 minutes

TOTAL - 1,386 g

Cost and Safety



Cost = **\$ 72.00**

Fuel Use = **83 kg**
estimated per month

Safety Rating

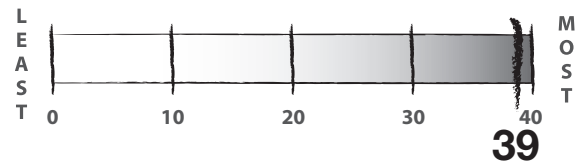

Emissions (in Test Kitchen)

Carbon Monoxide (CO)

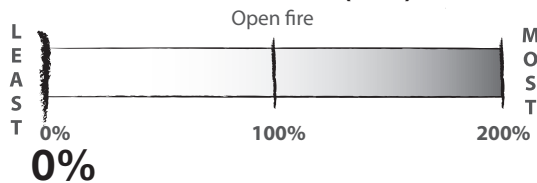

Particulate Matter (PM)

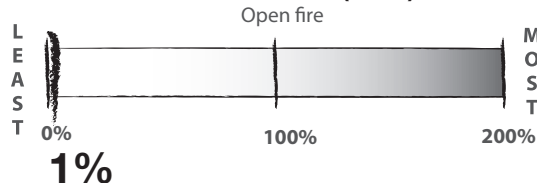

Ecostove

Origin: Brazil, Nicaragua, Honduras

Weight: 45 kilos

Fuel Type: Wood

Contact: Brazil: ECOFOGÃO Ltda, Rogerio Miranda ecofogao@ecofogao.com.br

Nicaragua: PROLEÑA Marlyng Buitrago; mbprolena@hotmail.com

Honduras: AHDESA, Ignacio Osorto Núñez; ignacio.osorto@ahdesa.org tel: (504) 226-4527

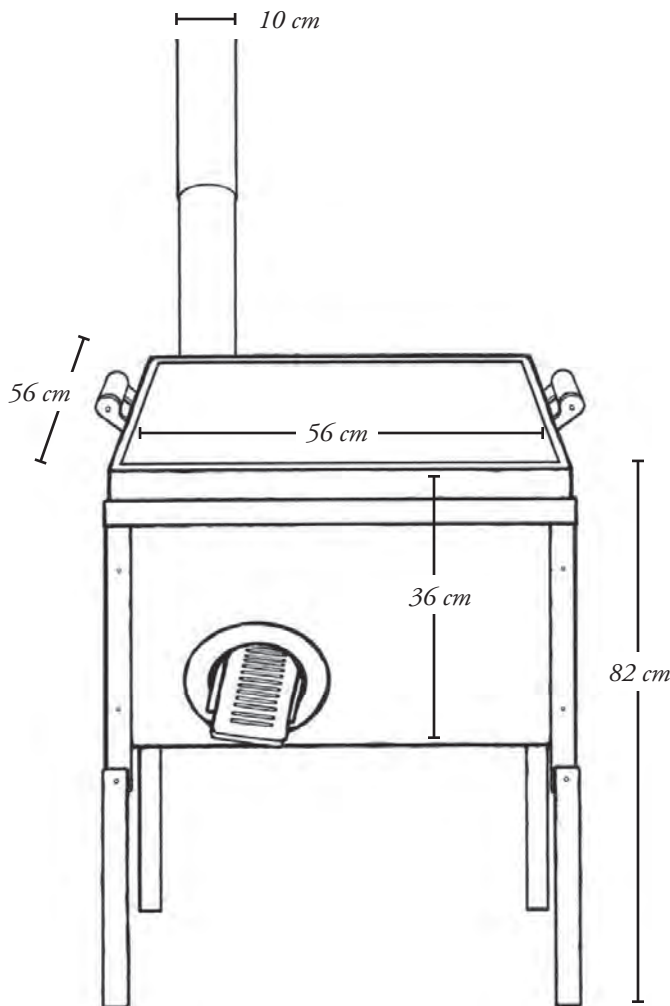

Description:

The Ecostove was developed by Rogerio Carneiro de Miranda in Nicaragua and Brazil. PROLEÑA has made thousands of stoves of this type in Nicaragua.

The Brazilian Ecostove has a heavy cast iron griddle that provides an excellent cooking surface. A handmade ceramic rocket combustion chamber is surrounded by lightweight cement insulation made from Aerated Autoclaved Cement. A channel under the griddle ensures improved heat transfer. Baffles direct hot flue gases to more evenly heat the griddle before exiting the chimney.

The body of the Ecostove is made from painted sheet metal and angle iron. The cooking surface is at waist height. The stove seems very well suited for making tortillas or for any type of grilling. Furthermore, it can be equipped with a coil to heat piped-in water.

Ecostove

Performance:

Like other griddle stoves, the Ecostove is designed to cook tortillas. Large amounts of grilled food can be prepared at the same time. Once the griddle is warm, the stove can boil water in about 30 minutes. However, it can use more fuel than an open fire to boil water from a cold start. This stove was a favorite of cooks at Aprovecho since large amounts of fried food can be prepared at the same time.

The heavy griddle takes time and fuel to heat initially, but once warm, the stove had about the same fuel economy as other griddle stoves.

The Ecostove chimney removed almost all the smoke from the test kitchen, creating a much safer and cleaner living space.



Ecostove

Test Results

Fuel Economy



Time to Boil 5L of Water - **38:36**

Energy Consumption compared to other stoves

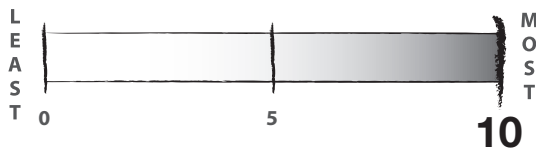

Fuel Used to Boil **1,171 g**

+ Fuel Used to Simmer **843 g**

5L of Water for 45 minutes

TOTAL - 2,014 g

Cost and Safety



Cost = **\$ 60.00**

Fuel Use = **121 kg**

estimated per month

Safety Rating

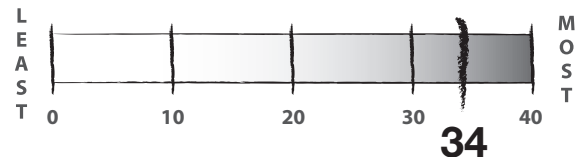

Emissions (in Test Kitchen)

Carbon Monoxide (CO)

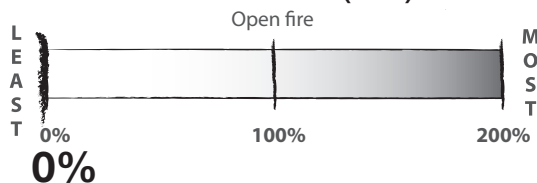

Particulate Matter (PM)

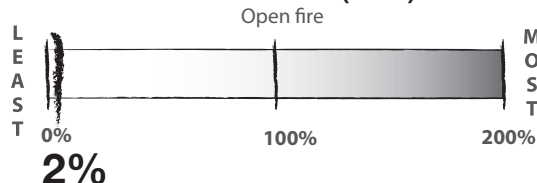

Wood Flame

Origin: Canada

Weight: 6 kilos

Fuel Type: Wood

Contact: Woodflame

6155 Des Grandes-Prairies
Blvd. Montreal (Québec),
Canada H1P 1A5

info@woodflame.com

tel: (514) 328-2929
toll free: (888) 664-6966

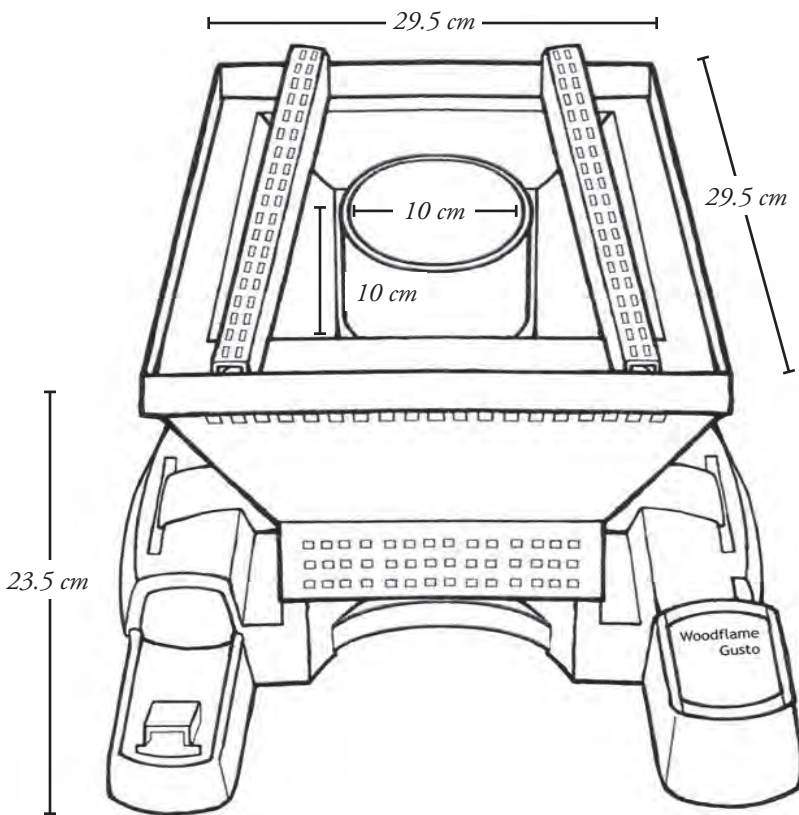
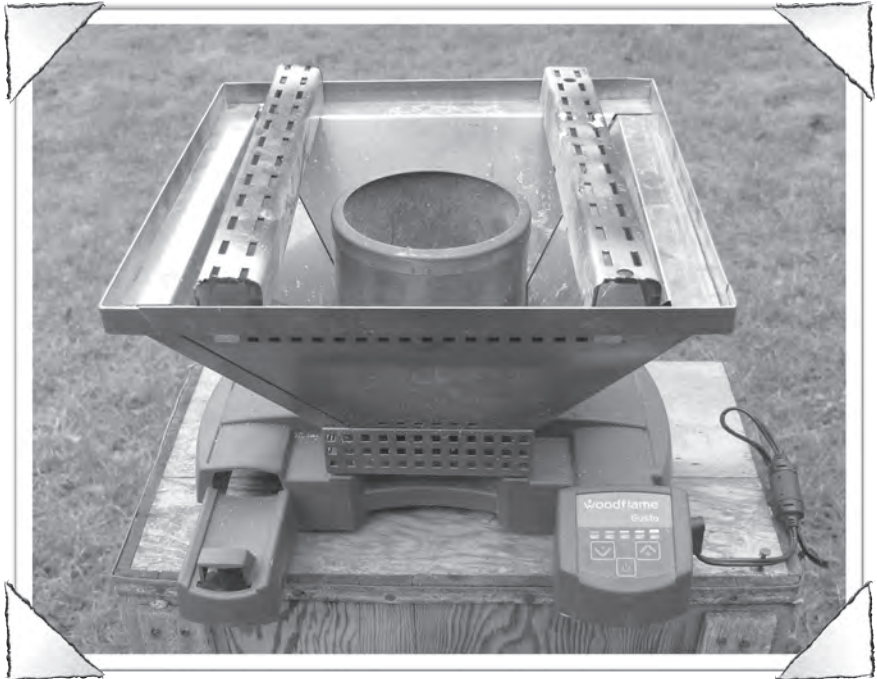

S.K.

Description:

The Wood Flame stove uses a small, externally powered electric fan to mix wood gases, air and flame to clean up combustion. In the bottom of the metal combustion chamber are many very small holes which send strong jets of air up through the burning wood.

A griddle used for grilling comes with the stove. When tested, the griddle was removed and supports were made to hold up the pot.

The combustion chamber is filled with small pieces of wood and lit. As the fire grows larger, the speed of the fan is increased manually, creating a small blast furnace. Wood is added to the combustion chamber by sliding it under the pot.

Blowing air up into the fire causes the fire to look very "jumpy" and frenzied. Flames turn from yellow to reddish to blue at various stages of burning.

Wood Flame

Performance:

The Wood Flame stove uses a batch of wood to grill foods. In these tests, the grill is removed so a full Water Boiling Test can be performed.

This is an interesting stove to use, with nine fan speeds. The amount of air is matched to the size of the fire. The stove is amazingly clean burning and uses a reduced amount of fuel. Feeding the stove under the pot is challenging, however.

The stove uses much less wood than the 3 Stone Fire and makes only 16% the CO and 2% of the PM made by the 3 Stone Fire.



Test Results

Fuel Economy



Time to Boil 5L of Water - **19:30**

Energy Consumption compared to other stoves

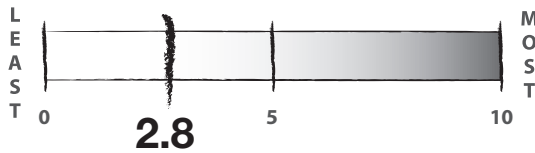

	Fuel Used to Boil	249 g
+	Fuel Used to Simmer	377 g
	<i>5L of Water for 45 minutes</i>	
	TOTAL -	626 g

Cost and Safety



Cost = **\$ 229.00**

Fuel Use = **38 kg**
estimated per month

Safety Rating

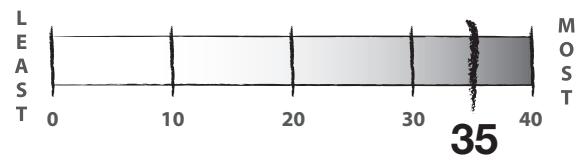

Emissions

Carbon Monoxide (CO)

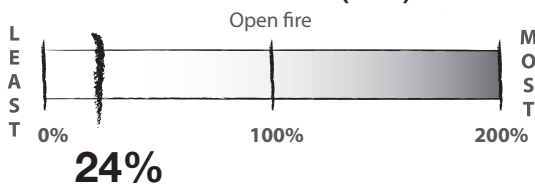

Particulate Matter (PM)

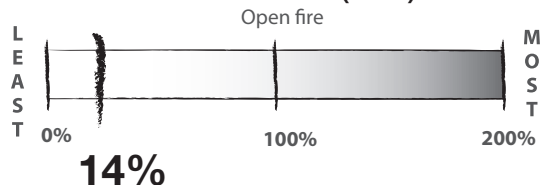

Wood Gas

Origin: Prototype

Weight: 1 kilo

Fuel Type: Wood

Contact: Dr. Paul Anderson
Biomass Energy Foundation

227 South Orr Drive
Normal, IL 61761
www.biomassenergyfoundation.org

tombreed2009@gmail.com
tel: (309) 452-7072

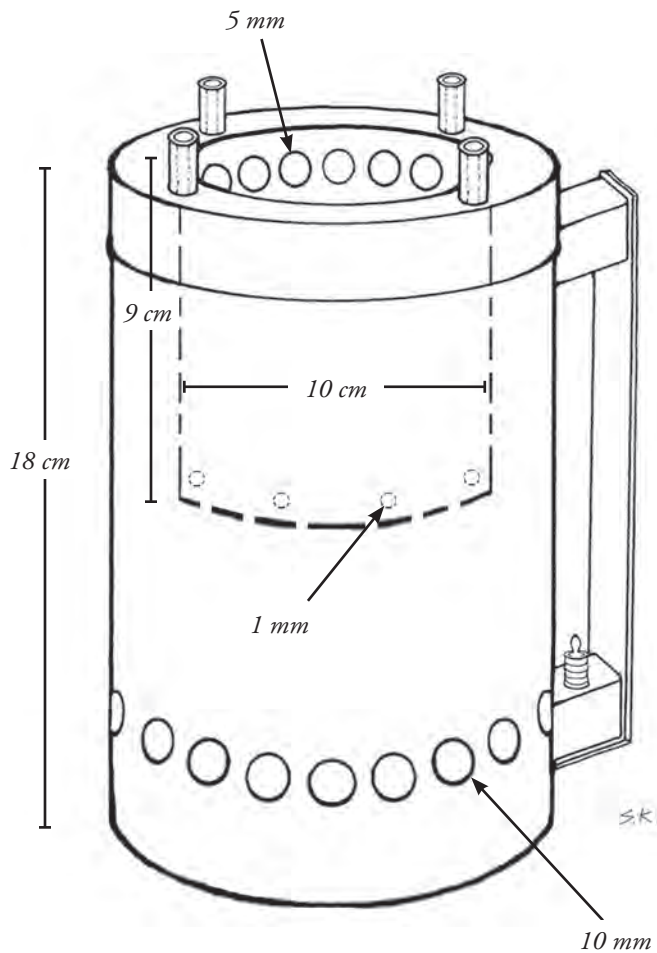

Description:

Dr. Tom Reed has spent decades studying and designing stoves in which wood gases are burned in two stages. This stove is started by top-lighting a batch of fuel that burns gases rising up into the fire zone.

The Wood Gas stove is made from sheet metal. The combustion chamber has holes near the bottom and larger holes near the top. A fan powered by an external battery blows jets of air into the fire. The fan is located under the fire.

This very lightweight stove could fit into a backpack. The handle makes moving the stove easy, even when lit.

Wood Gas

Performance:

The Wood Gas stove is very clean burning and uses less fuel than other stoves to boil and simmer water. Like the Wood Flame stove, it shows the ability of a fan to dramatically lower emissions.

This is a small camping stove, so to complete the Water Boiling Test, fuel must be added piece by piece to the fire under the pot. This manouver is a bit difficult.

How the stove burns wood seems almost miraculous. There is no smoke after starting the fire; fan stoves operate almost as cleanly as liquid-fueled stoves.

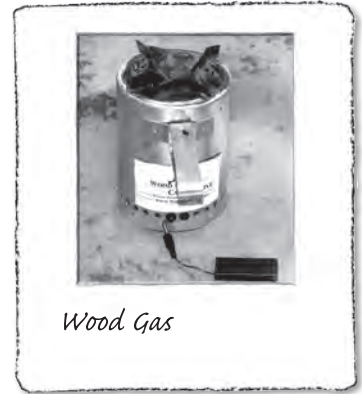

Wood Gas

Test Results

Fuel Economy



Time to Boil 5L of Water - **23:42**

Energy Consumption compared to other stoves

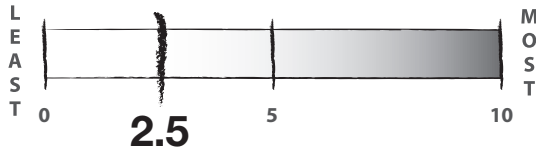

Fuel Used to Boil **235 g**

+ Fuel Used to Simmer **224 g**

5L of Water for 45 minutes

TOTAL - 459 g

Cost and Safety



Cost = **\$ 55.00**

Fuel Use = **28 kg**
estimated per month

Safety Rating

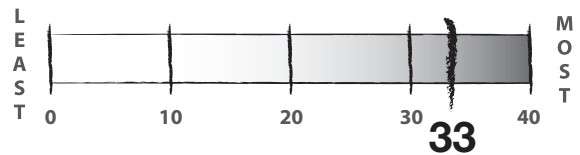

Emissions

Carbon Monoxide (CO)

Open fire

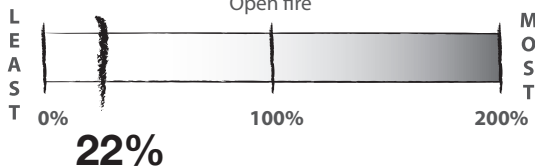

Particulate Matter (PM)

Open fire

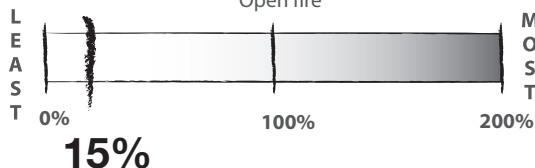

Mali Charcoal

Origin: Mali

Weight: 4.2 kilos

Fuel Type: Charcoal

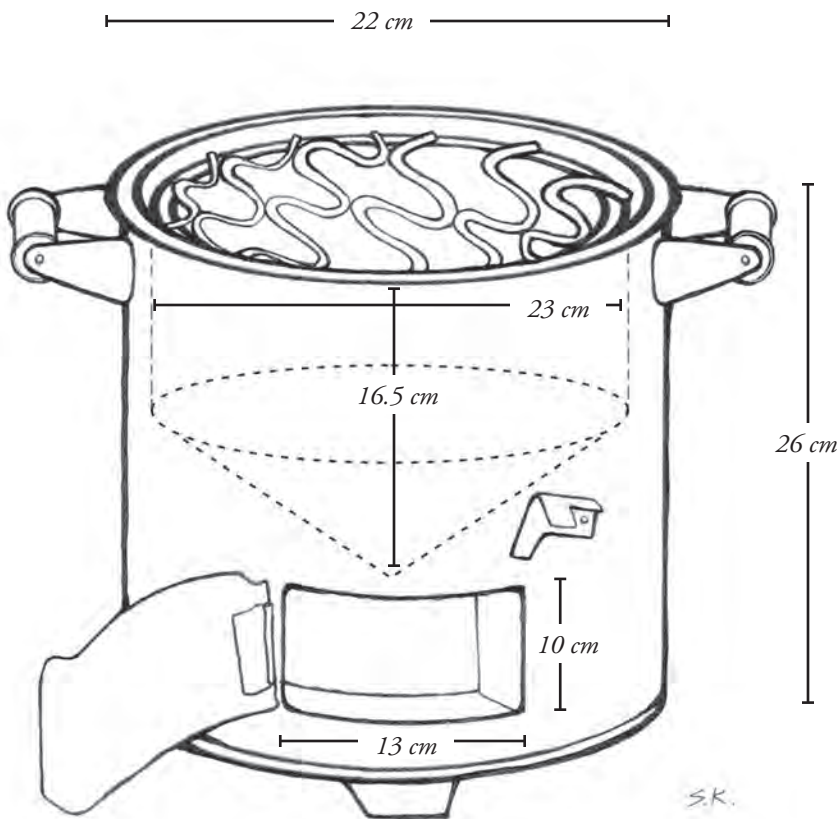

Description:

The Mali charcoal stove is made from silver-painted sheet metal. A door controls the amount of air entering underneath the charcoal. Controlling the air saves charcoal, especially during simmering, when less heat is needed. A ring can be removed to lower the pot when smaller amounts of charcoal are used.

An air gap between the conical combustion chamber and the outside of the stove helps reduce external temperatures. The conical combustion chamber helps the charcoal slide into the center as it is consumed.

A draft is created that pulls air up through the fire, increasing the heat available for boiling. This increased draft takes the place of blowing on the charcoal to increase firepower.

Mali Charcoal

Performance:

Opening the door increases the draft, which speeds combustion. Closing the door saves fuel and provides the reduced heat needed for efficient simmering.

It's easy to see why people like charcoal. Once the fire is lit, cooking with charcoal is almost as convenient as liquid fuel.

However, burning charcoal can emit high levels of CO. Especially at high power, the levels of CO emitted were dangerous.

On the other hand, emissions of PM were lower than from most wood-burning stoves.



Test Results

Fuel Economy



Time to Boil 5L of Water - **38:36**

Energy Consumption compared to other stoves

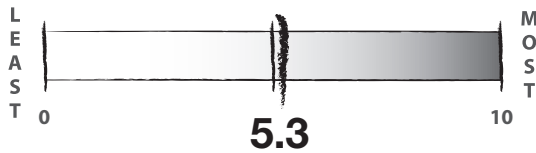

Fuel Used to Boil **406 g**

+ Fuel Used to Simmer **268 g**

5L of Water for 45 minutes

TOTAL - 674 g

Cost and Safety



Cost = **\$ 5.00**

Fuel Use = **40 kg**
estimated per month

Safety Rating

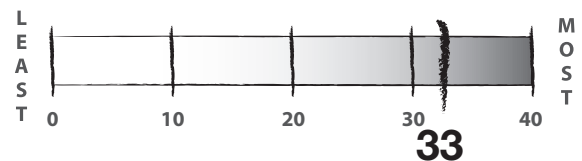

Emissions

Carbon Monoxide (CO)

Open fire

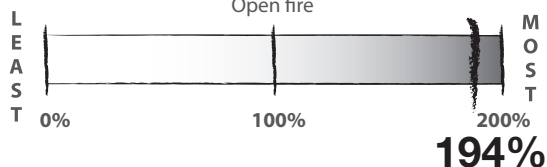

Particulate Matter (PM)

Open fire

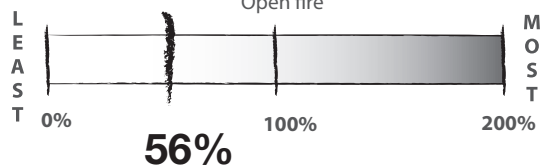

Gyapa Charcoal

Origin: Ghana

Weight: 9 kilos

Fuel Type: Charcoal

Contact:
Relief International/
EnterpriseWorks-VITA

1100 H Street NW, Suite 1200
Washington, DC 20005
www.enterpriseworks.org

tel: (202) 639-8660
fax: (202) 639-8664

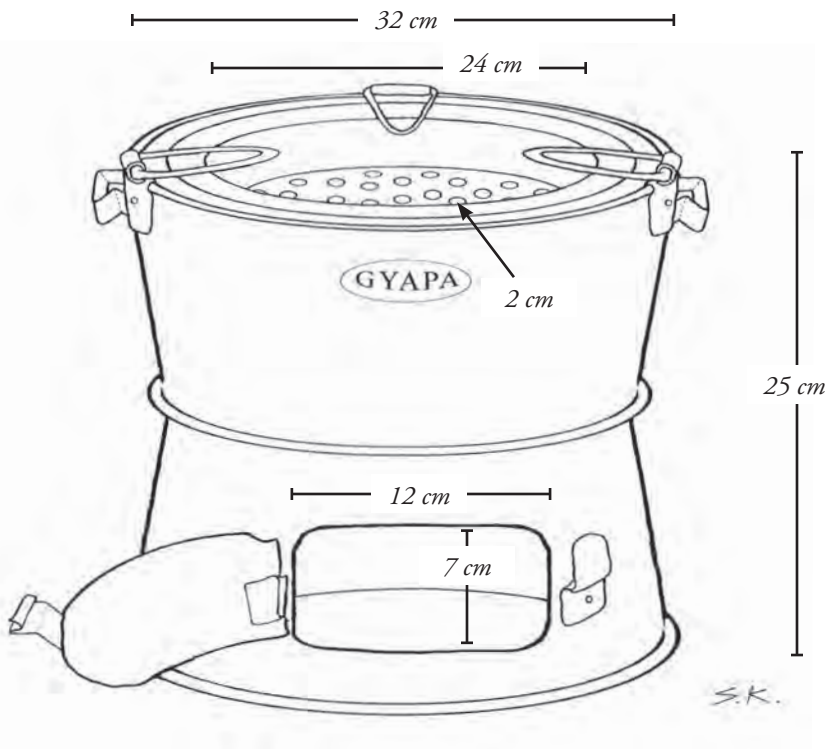
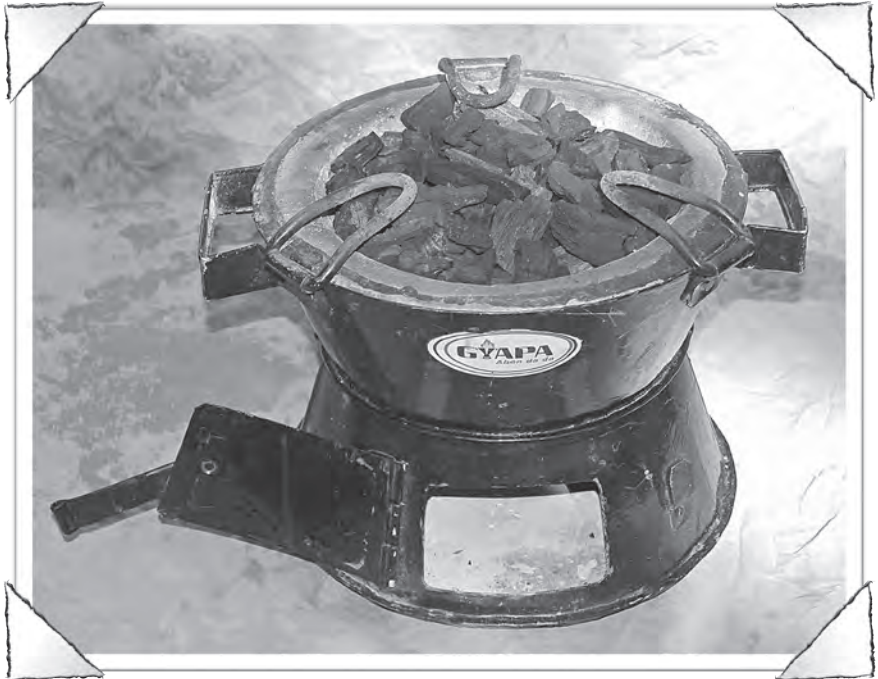

Description:

The Gyapa charcoal-burning stove is produced by Enterprise Works/VITA in Ghana. The stove has a ceramic liner bonded to the sheet metal body by an insulative, cement-like adhesive. The charcoal sits on a ceramic grate.

The door under the grate allows varying amounts of air to pass up into the fire, which raises and lowers firepower. Having a door on the opening under the fire seems to be an important feature in an improved charcoal-burning stove.

Three supports made from bent steel bars hold the pot close to the fire. Sturdy handles facilitate portability of the stove.

Gyapa Charcoal

Performance:

The Gyapa is somewhat faster to boil than the Mali stove while using less fuel. However, fuel use for both boiling and simmering is approximately the same for the two stoves.

The ceramic liner in the Gyapa may help to lower the temperature of the external stove body.

The stove boils water relatively quickly with the door open and simmers nicely with the door closed or mostly shut. Again, the amount of CO emitted was high while PM was reduced, compared to the 3 Stone Fire.

Closing the door lowers the firepower and reduces the emissions of CO. For this reason, charcoal stoves seem to be safer when simmering.



Gyapa Charcoal

Test Results

Fuel Economy



Time to Boil 5L of Water - **28:24**

Energy Consumption compared to other stoves

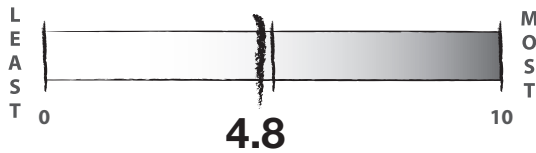

	Fuel Used to Boil	342 g
+	Fuel Used to Simmer	353 g
	<i>5L of Water for 45 minutes</i>	
	TOTAL -	694 g

Cost and Safety



Cost = **\$ 5.90**

Fuel Use = **42 kg**
estimated per month

Safety Rating

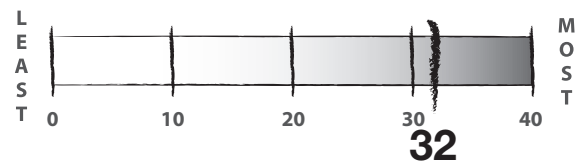

Emissions

Carbon Monoxide (CO)

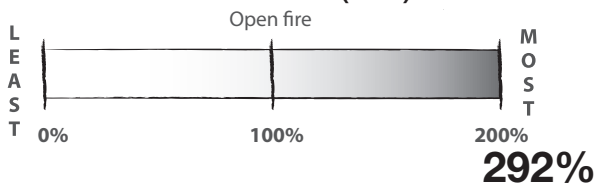

Particulate Matter (PM)

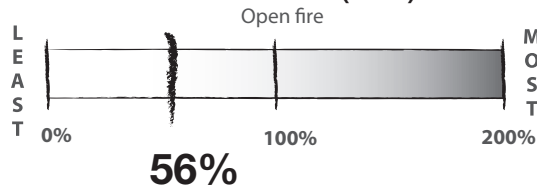

Propane

Origin: USA

Weight: 1.8 kilos

Fuel Type: Propane

Contact:

Century Tool & Manufacturing

1462 US Route 20 Bypass

P.O. Box 188

Cherry Valley, Illinois 61016

tel: (800) 435-4525

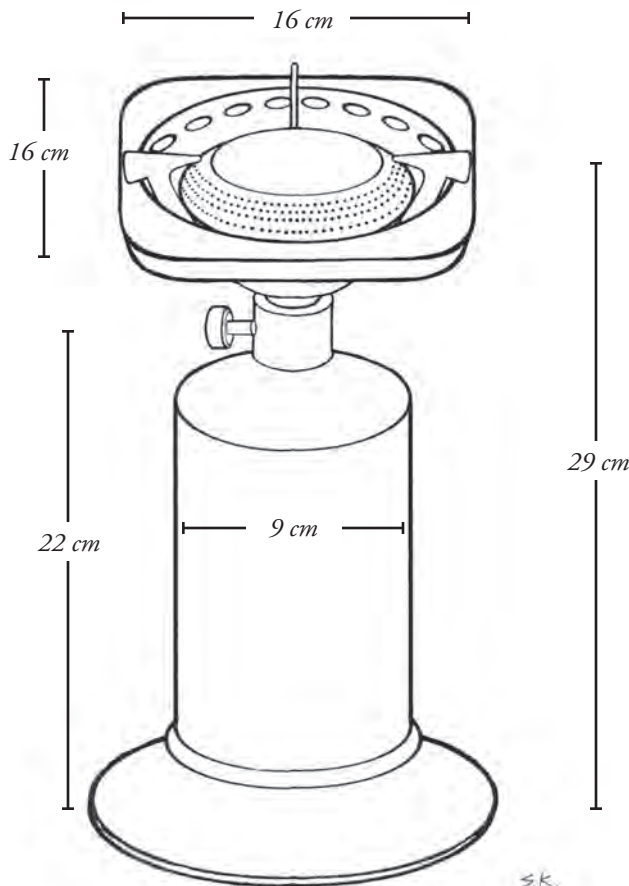

Description:

The stove consists of a single burner that screws onto a propane cylinder. A knob under the burner adjusts the rate of burn. It is very pleasant to go so easily from high to low power with the twist of a knob.

The stove burns with a hot blue flame, created by precise mixing of gas, air and flame. The gas exits under pressure, which aids the superior mixing. The stove sits on top of a wider stand that makes it more stable.

A propane stove delivers controllable, clean heat that is appreciated by cooks around the world.

Propane

Performance:

This camping-type stove is low powered. In Mexico, some propane stoves are not hot enough to make tortillas, so the 3 Stone Fire is used.

Cooking on a propane stove is quite luxurious after operating a wood-burning stove. It is pleasurable to turn on the stove and cook food without having to even think about tending the fire.

Propane can be somewhat dangerous as old storage cylinders and stoves begin to leak.

Time to boil is slightly faster than the 3 Stone Fire. Emissions are close to zero compared to the other stoves in these tests.



Test Results

Fuel Economy



Time to Boil 5L of Water - **23:00**

Energy Consumption compared to other stoves

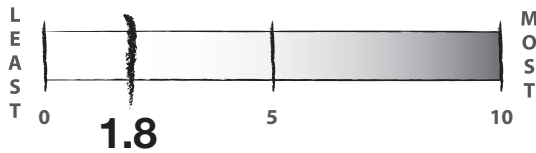

Fuel Used to Boil **64 g**

+ Fuel Used to Simmer **75 g**
5L of Water for 45 minutes

TOTAL - 139 g

Cost and Safety



Cost = **\$ 18.00**

Fuel Use = **8 kg**
estimated per month

Safety Rating

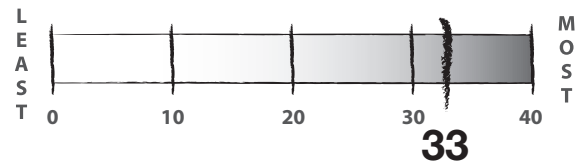

Emissions

Carbon Monoxide (CO)

Open fire

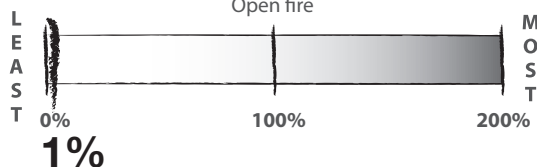

1%

Particulate Matter (PM)

Open fire

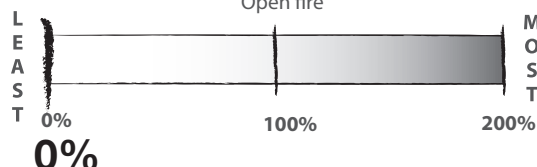

0%



Alcohol - Clean Cook Prototype

Origin: Nigeria

Weight: 5.1 kilos

Fuel Type: Alcohol

Contact:
Project Gaia, Inc.

Mr. Harry Stokes
22 Mummasburg Street,
PO Box 4190
Gettysburg, PA 17325

hstokes@projectgaia.com
www.projectgaia.com
tel: (717) 334-5594
fax: (717) 334-7313

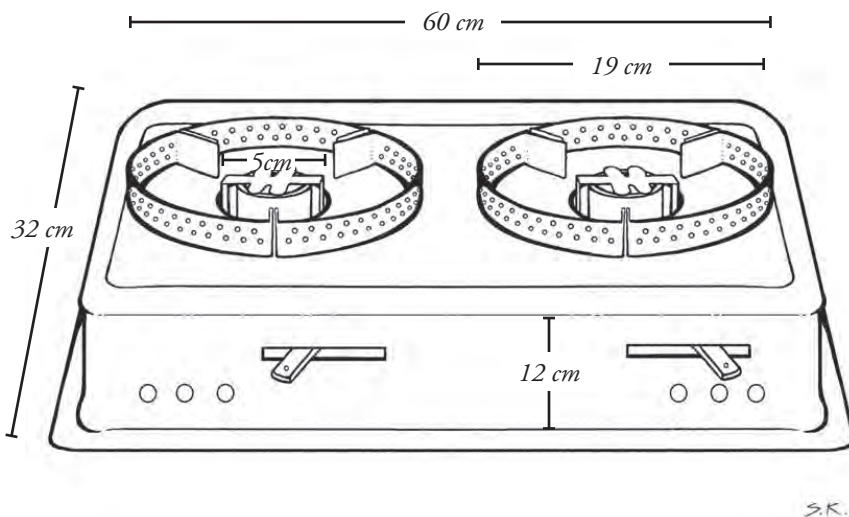

Description:

The Clean Cook alcohol stove prototype has two large fuel tanks filled with an absorptive material so the filled tank can be placed under the burner without leaking. Protective barriers placed over the fuel canisters prevent filling the stove while lit.

The stove body is stainless steel and attractively made. Two levers open and close the burners. By adjusting the levers, which close a cover over the fire, the power can be controlled. Two sheet metal pot supports help to shield the fire.

The tanks are not pressurized, allowing the fuel to burn in small, open cylinders underneath the pots. An unpressurized system is simple and does not depend on air tightness to work.

Alcohol - Clean Cook Prototype

Performance:

Alcohol has been a popular fuel for many years. Like kerosene, it has been used on boats when propane is considered too dangerous.

Alcohol stoves have a reputation for being somewhat low powered. In this case, the pot used in the Water Boiling Test was covered, which helped the water reach full boil but makes comparisons with other stoves using uncovered pots problematic. The lid was removed for simmering.

The stove cooks food like other liquid-fueled stoves, without tending. The cook can work on other tasks and gain hours once spent adjusting the fire.



Test Results

Fuel Economy



Time to Boil 5L of Water - **36:36**

Energy Consumption compared to other stoves

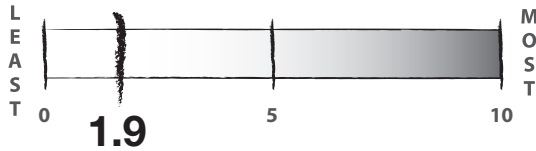

Fuel Used to Boil **148 g**

+ Fuel Used to Simmer **213 g**

5L of Water for 45 minutes

TOTAL - 361 g

Cost and Safety



Cost = **\$ 50.00**

Fuel Use = **22 kg**
estimated per month

Safety Rating

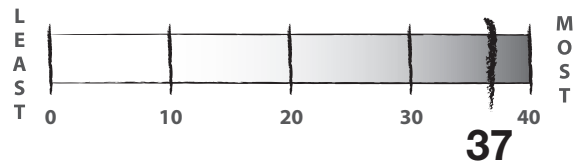

Emissions

Carbon Monoxide (CO)

Open fire

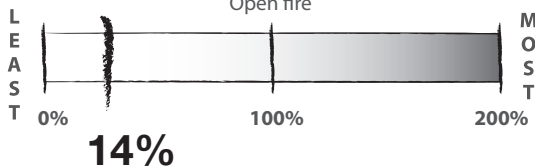

Particulate Matter (PM)

Open fire

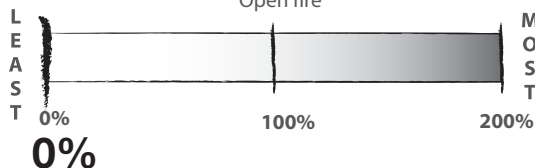

Kerosene

Origin: Hong Kong

Weight: 2.3 kilos

Fuel Type: Kerosene

Contact:
Solar Stoves

B/32 Shanker Tekari
Jamnagar, Gujarat
India 361004

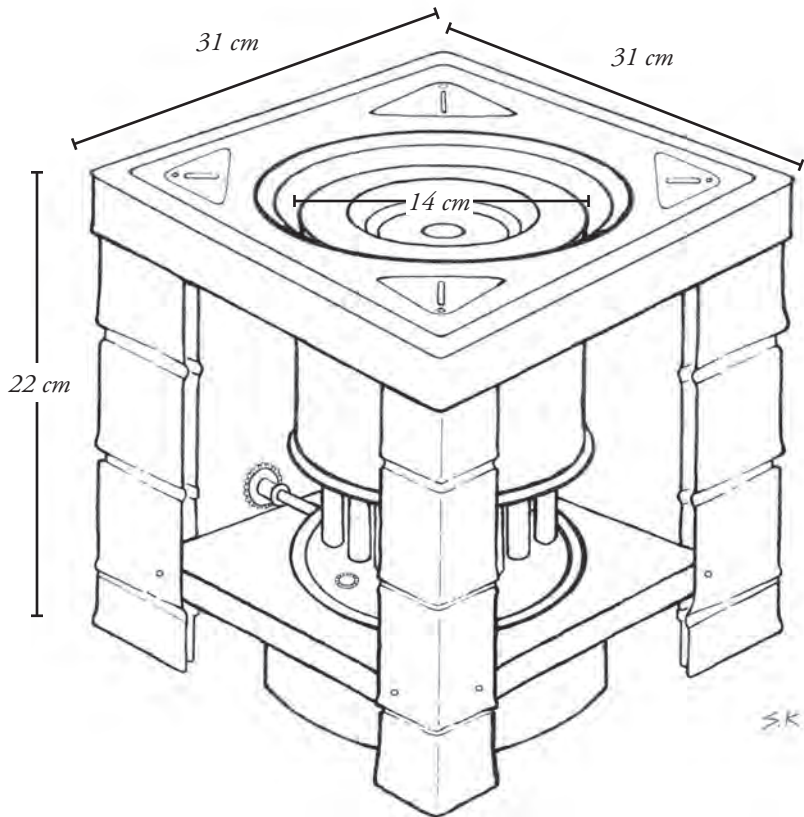
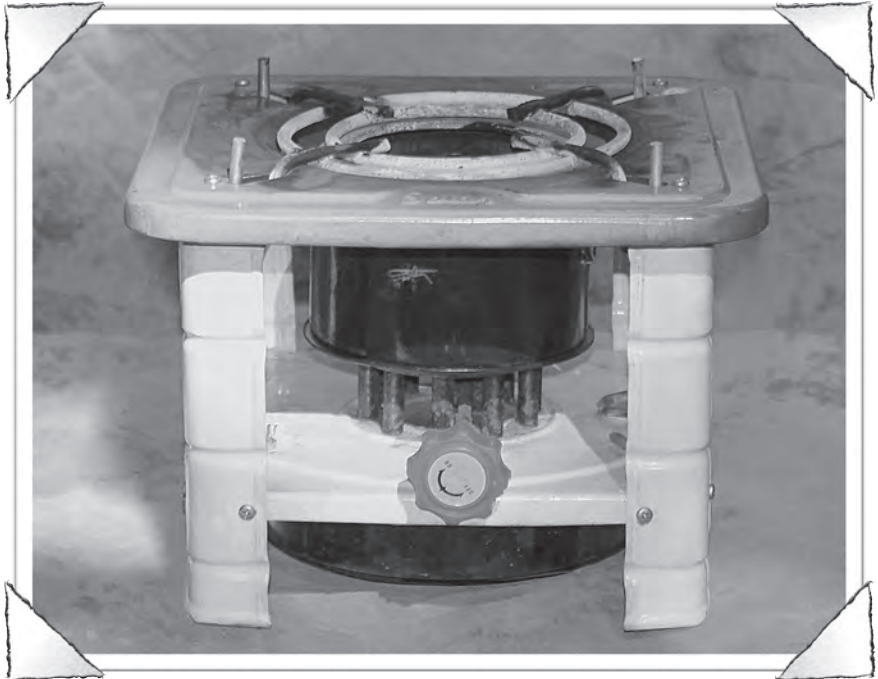

Description:

This kerosene stove uses wicks to bring kerosene into a combustion chamber where, with proper adjustments such as trimming the wicks and having the wicks at the appropriate height, a blue flame is created under the pot.

When correctly adjusted, the stove can burn cleanly. However, as received, the stove is somewhat smoky.

An adjustable knob moves the multiple wicks up and down. In this way, higher and lower power can be achieved. The wicks release the correct amount of gases that combust in a vertical chimney. The evolution of this simple-but-effective system has created a remarkable technology that effectively burns the unpressurized fuel.

A large tank under the stove holds the kerosene. The stove body is made of painted sheet metal.

Kerosene

Performance:

The short internal chimney helps the kerosene stove burn with a blue flame when adjusted correctly. To operate the stove cleanly may take time and practice, and the stove may need to be rebuilt. As received, the stove was smoky and the stove tank leaked.

However, after the stove was set up properly, it ran well without much tending.

Emissions, while low, are appreciably higher than with propane and alcohol.



Kerosene

Test Results

Fuel Economy



Time to Boil 5L of Water - **41:54**

Energy Consumption compared to other stoves

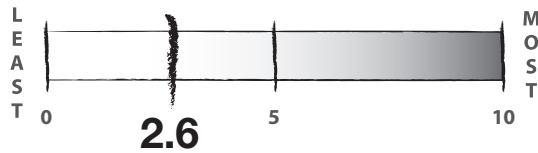

2.6

Fuel Used to Boil **115 g**

+ Fuel Used to Simmer **132 g**

5L of Water for 45 minutes

TOTAL - 247 g

Cost and Safety



Cost = **\$ 9.50**

Fuel Use = **15 kg**
estimated per month

Safety Rating

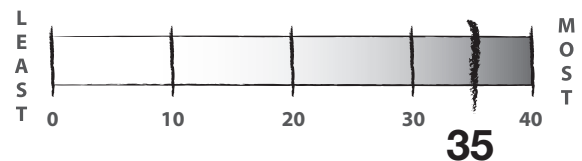

35

Emissions

Carbon Monoxide (CO)

Open fire



48%

Particulate Matter (PM)

Open fire

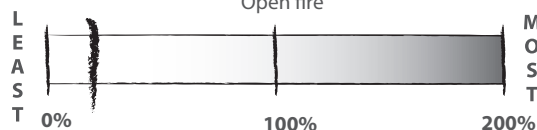

20%



Parabolic Solar Cooker

Origin: USA

Weight: 103 kilos

Fuel Type: Sunshine

Contact:
Aprovecho Research
Center

PO Box 1175
Cottage Grove, Oregon 97424

www.aprovecho.org
tel: 541 767-0287

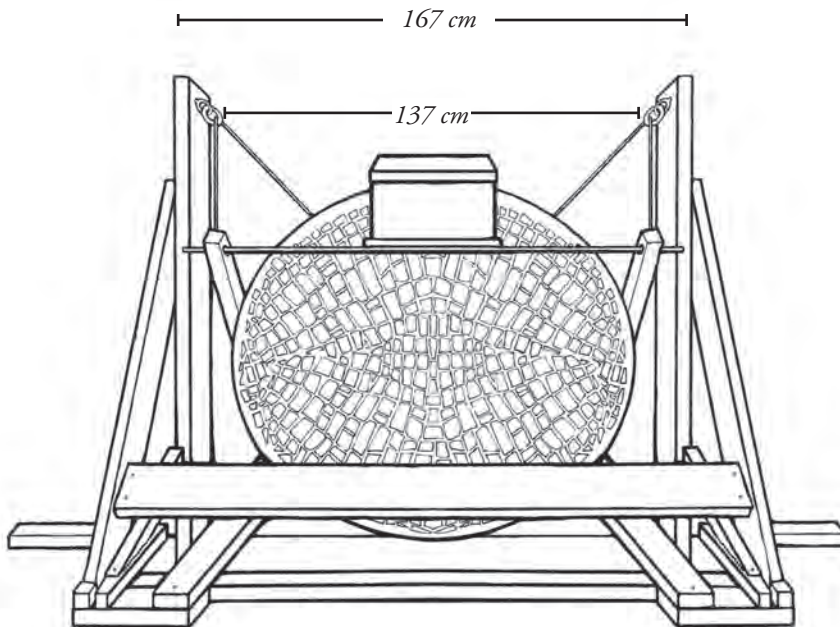
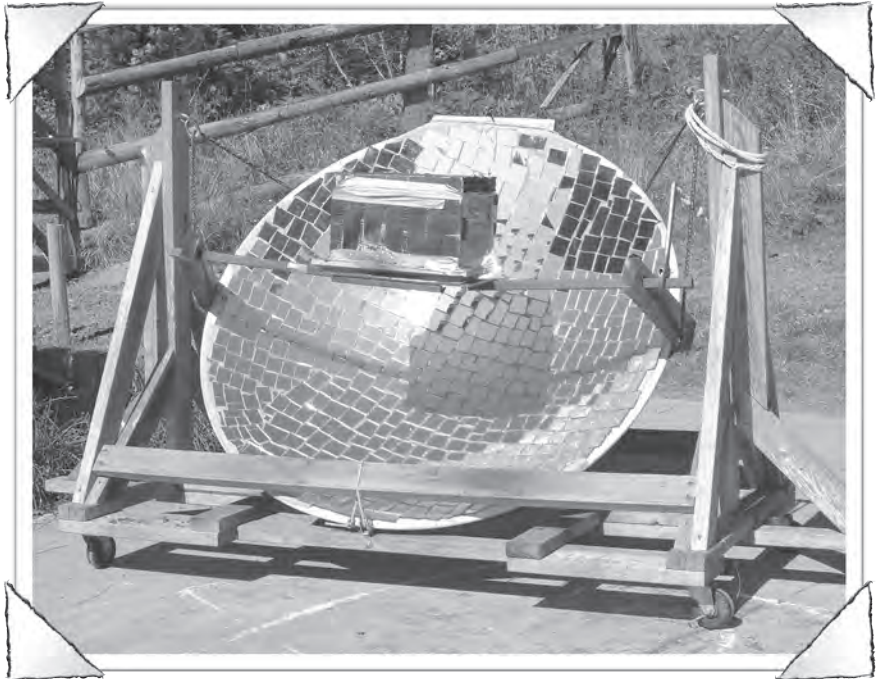

Description:

The parabolic solar cooker was built by students at Aprovecho. It was made from a recycled fiberglass satellite dish six feet in diameter. One-inch by one-inch square mirrors were glued to the surface with silicon adhesive.

A metal support holds an insulated box with a glass bottom at the focal point. Reflected sunlight passes through glass on the bottom of the insulated box. The insulation helps capture the heat and increase the efficiency of heat transfer. The box is placed around the pot and can be removed by the cook.

The parabola is supported inside a wooden frame on rollers so the reflector can follow the moving sun. The solar cooker needs to be re-aimed at the sun about every half hour. The stove can also be used with a wok for grilling. One or two pounds of food can be fried quite successfully.

Parabolic Solar Cooker

Performance:

The solar cooker can generate over 2,000 watts of power, boiling 5 L of water in an average of 70 minutes.

Solar cooking uses no fuel and makes no emissions. The solar cooker is the only stove tested that does not use diminishing resources to cook food. The fuel is free, as long as the sun is shining.

The cook can usually stand behind the reflector to stir food. However, the glare when standing in front of the dish can be intense.

It is necessary to be careful, because the heat at the focal point is invisible and over 550° C.

Cooking with this parabolic dish is easy compared to using wood, because it only requires tracking the sun once in a while.

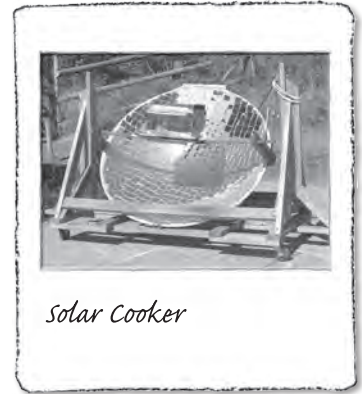

Test Results

Fuel Economy



Time to Boil 5L of Water - **70:00**

Energy Consumption compared to other stoves

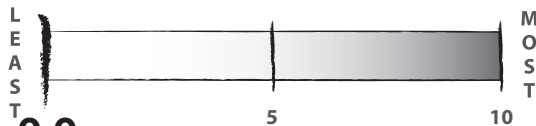

0.0

Fuel Used to Boil **0 g**

+ Fuel Used to Simmer **0 g**

5L of Water for 45 minutes

TOTAL - **0 g**

Cost and Safety



Cost = **\$ 55.00**

Fuel Use = **0 kg**
estimated per month

Safety Rating

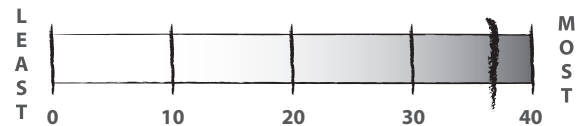

32

Emissions

Carbon Monoxide (CO)

Open fire



0%

Particulate Matter (PM)

Open fire

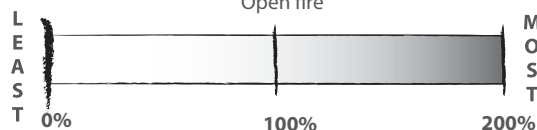

0%



Chapter 2

Stove Rankings

This chapter contains lists and graphs showing how each stove ranks in eight important performance categories:

1. Time to Boil

Waiting for a pot to boil, or for tortillas to cook on a slow stove, can be frustrating. Cooks and families often appreciate a powerful, adjustable stove.

2. Fuel to Cook and 3. Energy to Cook

When looking at fuel consumption, it is important to consider the amount of energy in each type of fuel. For instance, propane has over twice the amount of useful energy in each gram compared to wood. When a particular stove uses less fuel, it does not necessarily use less energy.

4. Carbon Monoxide and 5. Particulate Matter Emissions

Carbon monoxide (CO) is a deadly odorless, poisonous gas. Inhaling particulate matter (PM) can cause acute respiratory infections and a host of other diseases. To protect the health of a family, high levels of indoor air pollution must be prevented. Please note that measures of particulate matter include total emissions produced by the stoves, even chimney stoves, which protect the user from these emissions. For this reason, while the chimney took almost all of the pollution out of the test kitchen, the PM results are higher, as measured under the collection hood (see page 83) from the chimney exit.

6. Safety Ratings

Using fire can be dangerous. Burns are often horribly disfiguring. A stove should be as safe as possible. Stoves were evaluated for safety using safety evaluation methods developed by Nathan Johnson at Iowa State University. Details on the evaluation procedures can be found in Appendix C on page 121.

7. Cost to Purchase and 8. Monthly Fuel Use

The cost to build or purchase a stove and the continual burden of fuel costs can be very important factors in stove choice. A more expensive stove that saves money by using less fuel can be a worthwhile purchase. However, if the initial cost is too high, the stove may never become popular. If fuel is scarce in the area where the stove is being used, fuel use may be the most important factor.

What is the best stove for you?

Some people may think that the cost of the stove is most important. Others might put a higher value on time to boil, fuel use or safety. Which categories are most important to your market?

A total value for each stove can be determined by adding the score in each of the categories that are most important to you. The best stove in each category can be given a score of 1, the next 2, and so on. In this way, the stove with the lowest total score would be the “best” and might suit your needs. As we’ve said, the choice of a best stove may be based on preferences that are outside of these categories. For example, griddle stoves can make tortillas and simmer multiple pots using one fire. The griddle stove uses more energy to boil a single pot, but it may cook food more successfully.

We strongly recommend that local cooks try the proposed stove. Only cooks will know if a stove is suitable or not.

1. Time to Boil

5 L of water

Shortest Time

1. Vita Stove
2. Mud/Sawdust
3. Uganda 2-pot
4. Wood Flame Fan
5. Ghana Wood
6. 20 L Can Rocket
7. Propane
8. Wood Gas Fan
9. 3 Stone Fire
10. Onil
11. Gyapa Charcoal
12. Alcohol - Clean Cook
13. Patsari Prototype
14. Mali Charcoal
15. Ecostove
16. Kerosene
17. Justa
18. Parabolic Solar Cooker

Longest Time

#1 Vita Stove
14.0 minutes



#2 Mud/Sawdust
16.0 minutes



#3 Uganda 2-pot
16.2 minutes

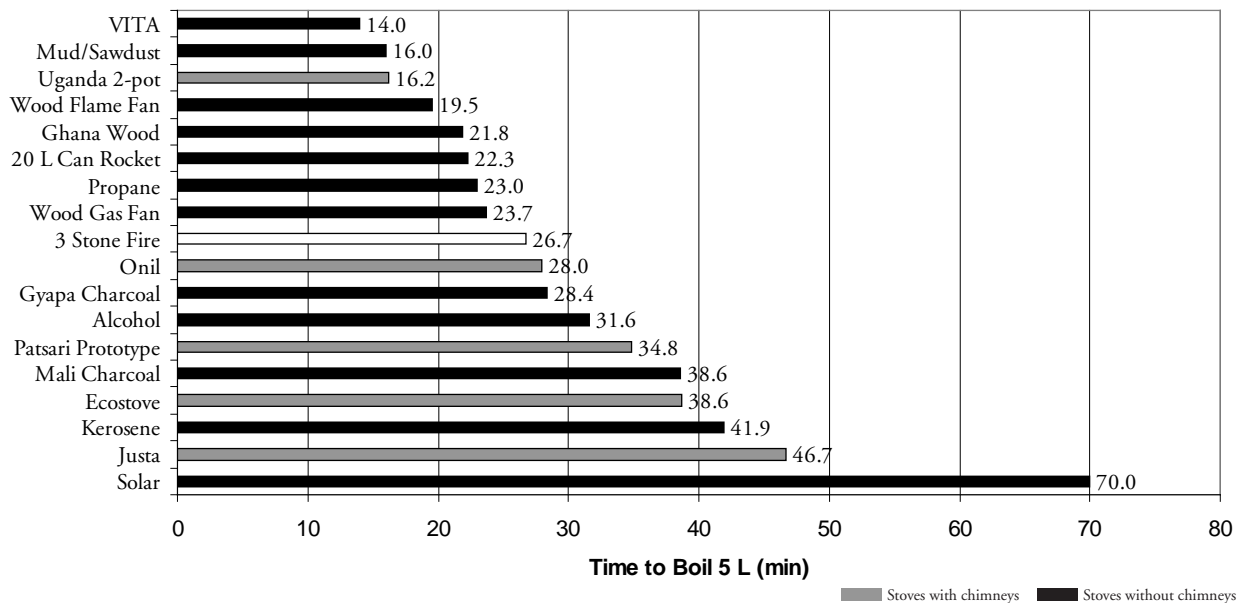

2. Fuel to Cook

Boil and Simmer 5 L of water for 45 minutes

Least Fuel Used

1. Parabolic Solar Cooker
2. Propane
3. Kerosene
4. Alcohol - Clean Cook
5. Wood Gas Fan
6. Wood Flame Fan
7. Mali Charcoal
8. VITA
9. Gyapa Charcoal
10. Uganda 2-pot
11. 20 L Can Rocket
12. Mud/Sawdust
13. Ghana Wood
14. 3 Stone Fire
15. Patsari Prototype
16. Justa
17. Onil
18. Ecostove

Most Fuel Used

#1 Parabolic Solar Cooker
0.0 grams



#2 Propane
139 grams



#3 Kerosene
247 grams

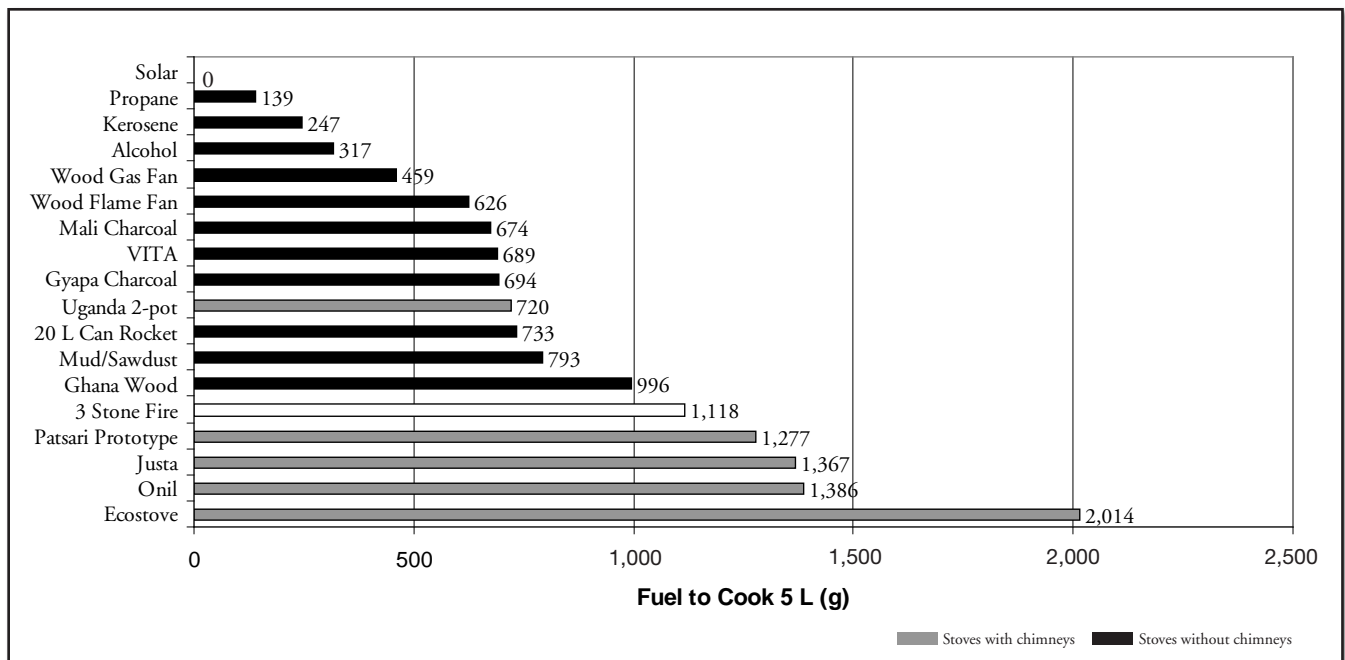

3. Energy to Cook

Boil and Simmer 5 L of water for 45 minutes

Least Energy

1. Parabolic Solar Cooker
2. Propane
3. Alcohol - Clean Cook
4. Wood Gas Fan
5. Kerosene
6. Wood Flame Fan
7. Uganda 2-pot
8. VITA
9. 20 L Can Rocket
10. Mud/Sawdust
11. Ghana Wood
12. Gyapa Charcoal
13. 3 Stone Fire
14. Mali Charcoal
15. Patsari Prototype
16. Justa
17. Onil
18. Ecostove

Most Energy

#1 Parabolic Solar Cooker
0.0 kJ



#2 Propane
6,670 kJ



#3 Alcohol - Clean Cook
6,766 kJ

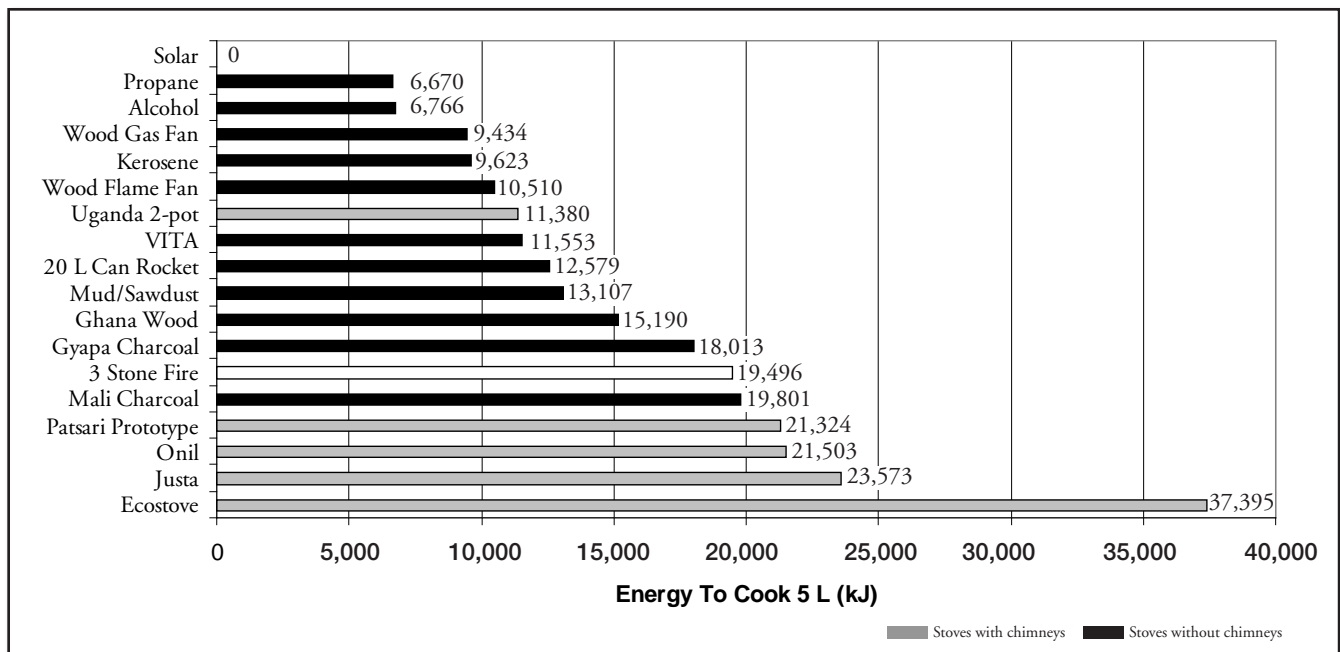

4. Carbon Monoxide Emissions

Boil and Simmer 5 L of water for 45 minutes

Least CO Released

1. Parabolic Solar Cooker
2. Propane
3. Alcohol - Clean Cook
4. Wood Gas Fan
5. Kerosene
6. Wood Flame Fan
7. 20 L Can Rocket
8. Patsari Prototype
9. Uganda 2-pot
10. Justa
11. Onil
12. VITA
13. Ecostove
14. Mud/Sawdust
15. Ghana Wood
16. 3 Stone Fire
17. Mali Charcoal
18. Gyapa Charcoal

Most CO Released

#1 Parabolic Solar Cooker
0.0 grams



#2 Propane
0.5 grams



#3 Alcohol - Clean Cook
5.3 grams



Please note that these are measures of total emissions produced by the stove (including emissions that would normally be exhausted from the house via a chimney), not emissions to which the cook is exposed. Many chimney stoves that resulted in low emissions in the test kitchen measure higher in the PM and CO emissions categories, which were measured under the collection hood from the chimney exit.

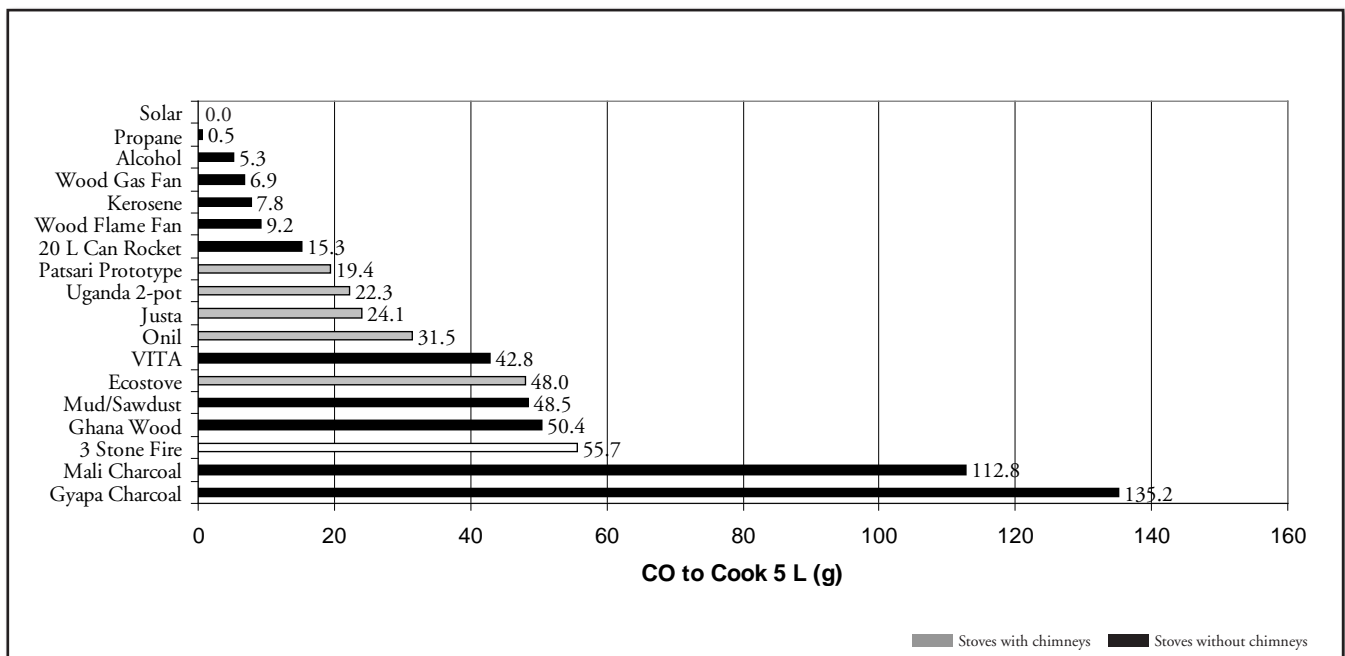

5. Particulate Matter Emissions

Boil and Simmer 5 L of water for 45 minutes

Least PM Released

1. Parabolic Solar Cooker
2. Alcohol - Clean Cook
3. Propane
4. Kerosene
5. Wood Gas Fan
6. Wood Flame Fan
7. Mali Charcoal
8. Gyapa Charcoal
9. Uganda 2-pot
10. Justa
11. Patsari
12. 20 L Can Rocket
13. Onil
14. VITA
15. Mud/Sawdust
16. 3 Stone Fire
17. Ghana Wood
18. Ecostove

Most PM Released

#1 Parabolic Solar Cooker
0.0 mg



#2 Alcohol - Clean Cook
4.4 mg



#3 Propane
4.5 mg



Please note that these are measures of total emissions produced by the stove (including emissions that would normally be exhausted from the house via a chimney), not emissions to which the cook is exposed. Many chimney stoves that resulted in low emissions in the test kitchen measure higher in the PM and CO emissions categories, which were measured under the collection hood from the chimney exit.

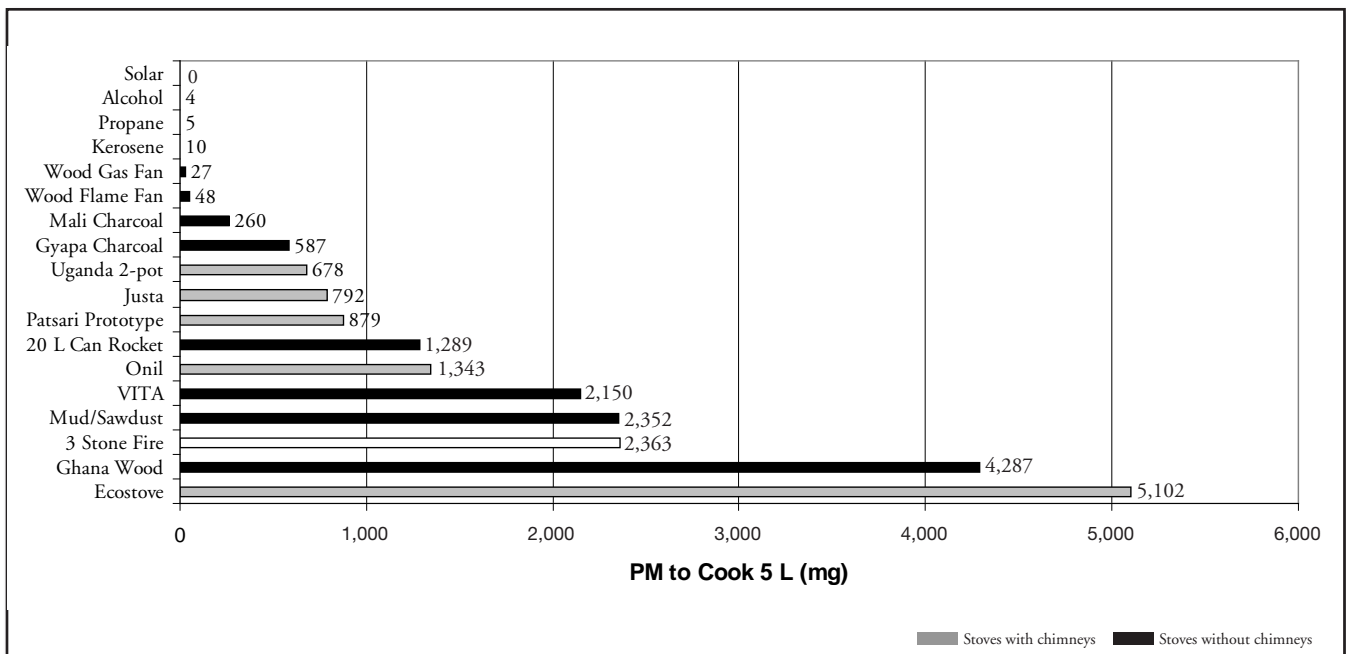

6. Safety Ratings

Evaluated on 10 criteria (see Appendix)

Most Safe

1. Onil
2. Justa
3. Alcohol - Clean Cook
4. Uganda 2-pot
5. Patsari Prototype
6. Kerosene
7. Wood Flame Fan
8. Ecostove
9. Propane
10. Mali Charcoal
11. Wood Gas Fan
12. Mud/Sawdust
13. 20 L Can Rocket
14. Parabolic Solar Cooker
15. Gyapa Charcoal
16. Ghana Wood
17. VITA
18. 3 Stone Fire

Least Safe



#1 Onil
39 out of 40



#2 Justa
38 out of 40

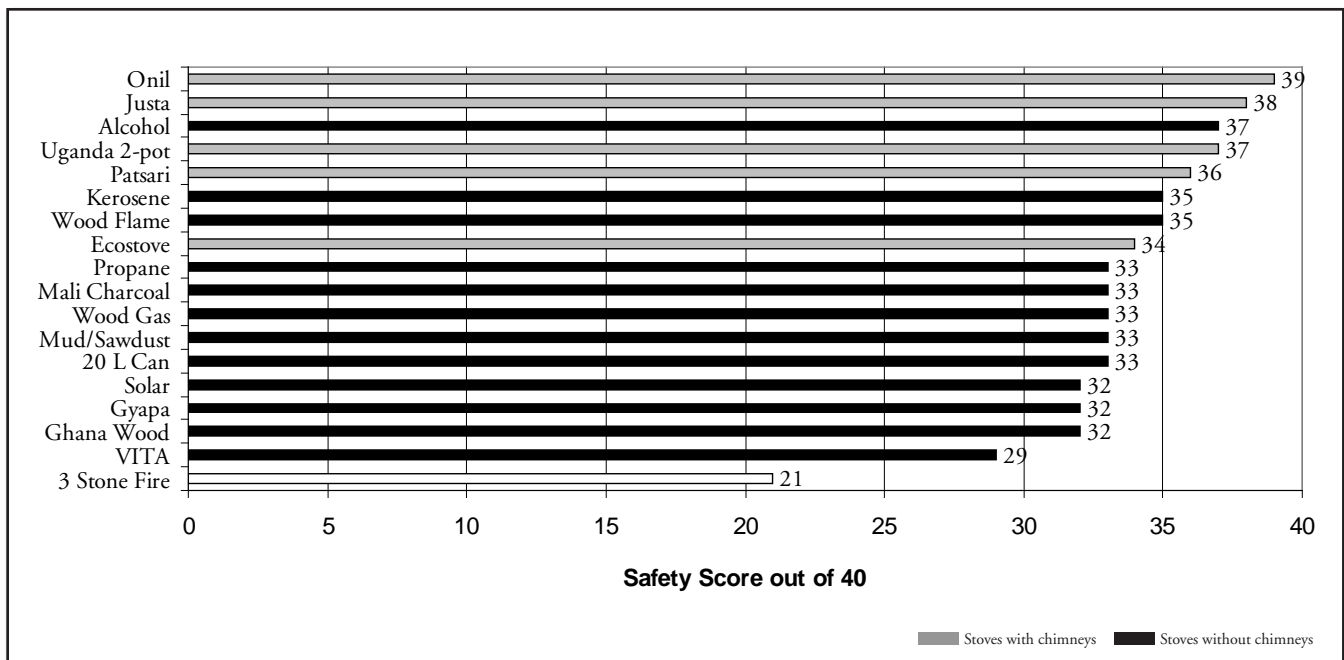

#3 Alcohol & Uganda 2-pot
37 out of 40

7. Cost to Purchase

In US \$

Least Expensive

1. 3 Stone Fire
2. Mud/Sawdust
3. 20 L Can Rocket
4. VITA
5. Mali Charcoal
6. Ghana Wood
7. Gyapa Charcoal
8. Kerosene
9. Propane
10. Alcohol - Clean Cook
11. Patsari Prototype
12. Uganda 2-pot
13. Solar Cooker
14. Ecostove
15. Onil
16. Justa
17. Wood Gas Fan
18. Wood Flame Fan

Most Expensive

**#1 3 Stone Fire
Free**



**#2 Mud/Sawdust
Free**



**#3 20L Can Rocket
Free**

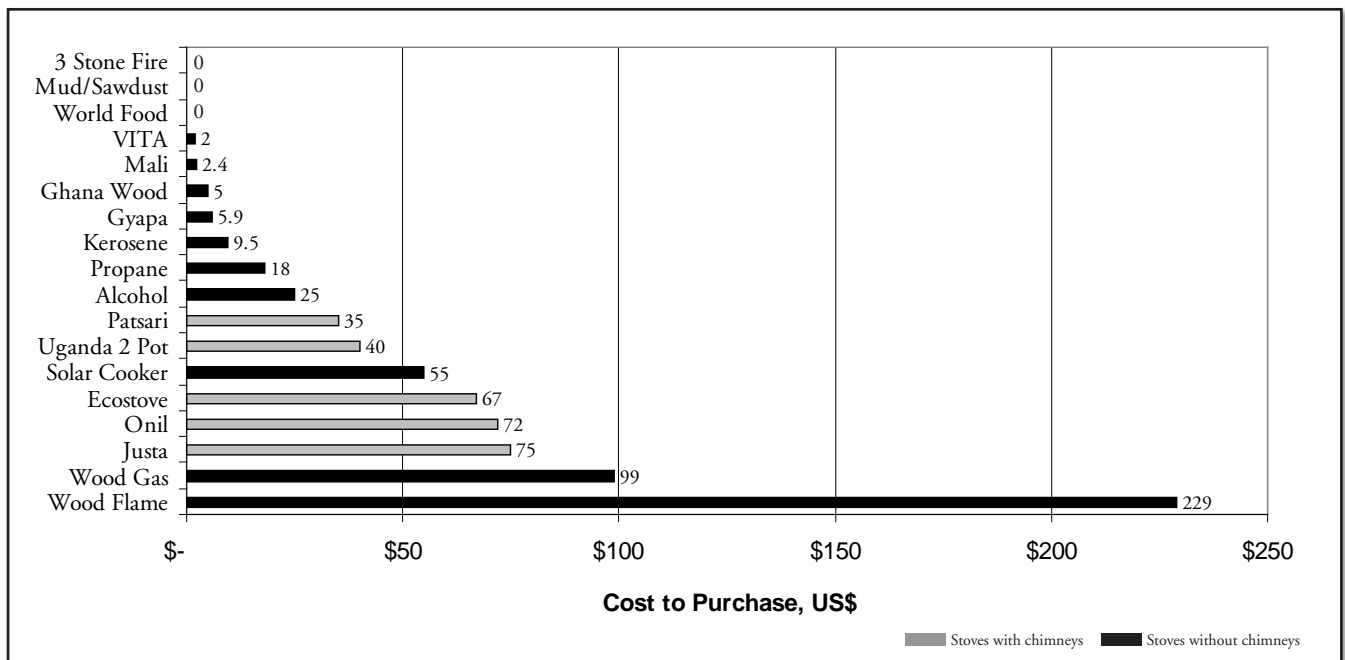

8. Monthly Fuel Use

Wood Burning Stoves (kg / month)

Least Fuel Used

1. Wood Gas Fan
2. Wood Flame Fan
3. VITA
4. Uganda 2-pot
5. 20 L Can Rocket
6. Mud/Sawdust
7. Ghana Wood
8. 3 Stone Fire
9. Patsari Prototype
10. Justa
11. Onil
12. Ecostove

Most Fuel Used

#1 Wood Gas Fan
28 kg /month



#2 Wood Flame Fan
38 kg /month



#3 VITA Stove
41 kg /month

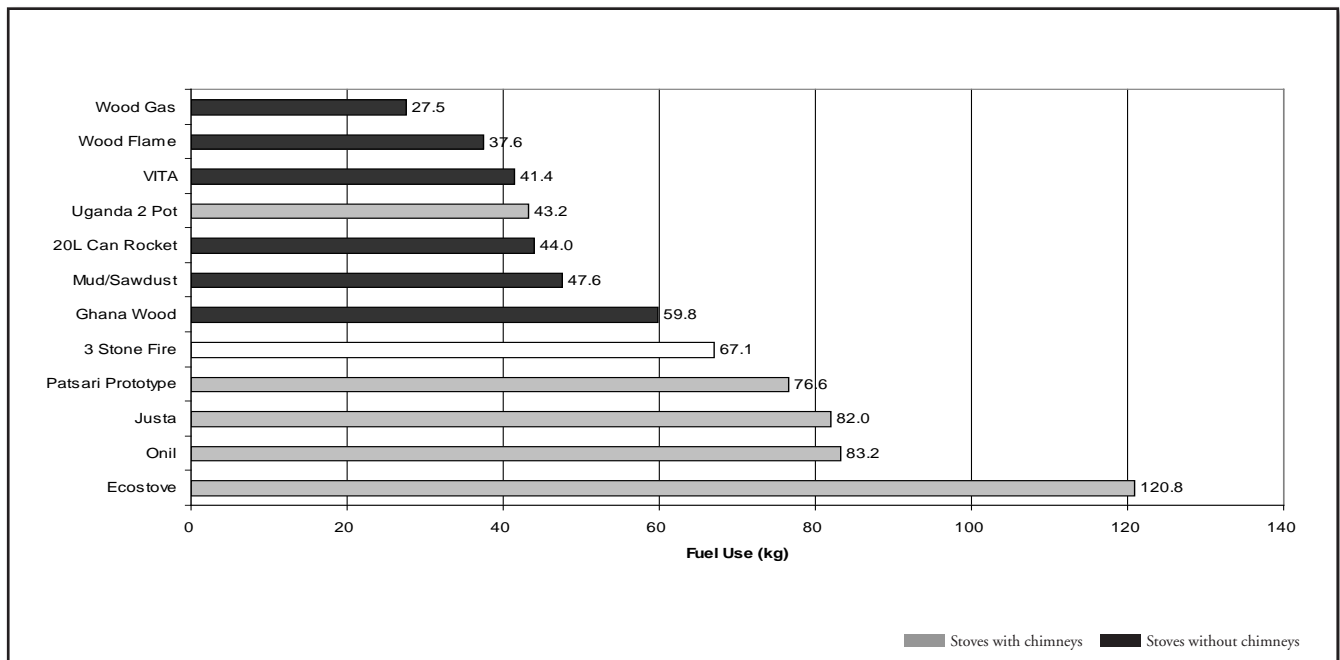

Chapter 3

Learning From Improved Cook Stoves

Why do some wood-burning cook stoves boil water faster?

The 3 Stone Fire (Figure 1) is often thought of as a fast way to boil water. If an improved stove doesn't boil water as quickly, people may switch back to the 3 Stone Fire when they are in a hurry.

An improved stove designed to boil water quickly must have sufficient firepower. The heat created in the stove has to be high enough to cook local foods in acceptable times. To boil water quickly, as much heat as possible has to get from the fire into the pot. It is important to make sure the flame and hot gases are directed right at the pot. Increasing the temperature of the hot gases helps the stove boil water faster than the 3 Stone Fire.



Figure 1

Eight stoves in these tests boiled 5 L of water faster than the 3 Stone Fire (Figure 2). The three stoves that boiled water the fastest in these tests were the VITA, Mud/Sawdust, and Uganda 2-pot (Figure 3). They each have similar narrow channels around the pot that force the hot gases to flow against the bottom and sides of the pot.

If the channel around the pot is not narrow enough, the hot gases will flow up the middle of the channel, avoiding the surface of the pot. At the same time, it is very important that the increased friction in the narrow channel does not slow the flow of gases and air through the stove too much, otherwise the heat transfer to the pot will be decreased.

The flow of hot gases is like a river of water. The river of gases should not meet a restriction, such as a dam, that would diminish its volume or speed. If the river becomes half as wide, it needs to also become twice as deep to continue flowing at the same speed. In cleaner burning wood-fired stoves, most of the heat is brought to the pot by the hot gases. If the gases move slowly, less heat makes it into the pot.

Gas has very little mass, so the few hot molecules in the moving gases cannot transport much heat energy per volume. It takes a lot of hot gas to deliver the required heat to a pot or griddle. For this reason, more heat is brought to the pot by increasing both the amount and speed of the hot gases without reducing their temperature.

Radiation from the fire can be important in transferring heat, but to be effective, the radiant surface has to be hot and close to the pot. In wood-burning stoves, bringing the pot closer to the fire can increase smoke and harmful pollution. In cleaner burning stoves, the pot is farther away from the fire and is therefore mostly warmed by hot flue gases.

Four techniques to boil water faster:

1. Create a large enough fire in the combustion chamber.
2. Force the gases to flow against the bottom and sides of the pot in narrow channels.
3. Make sure the gases are as hot as possible.
4. Increase the speed of the hot gases flowing over the surface of the pot.



Figure 2 - Stoves that boil 5 L of water faster than the 3 Stone Fire

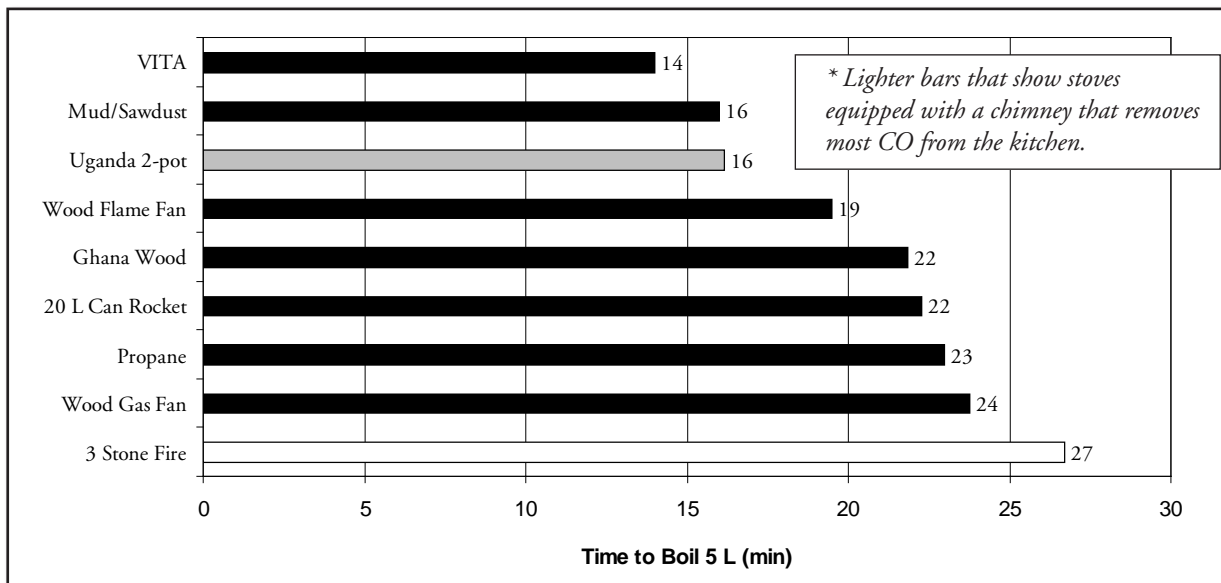
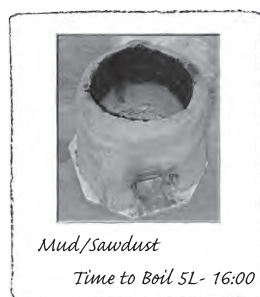

Figure 3 Fastest to Boil 5 L of Water



Why do some wood stoves use less fuel?

The 3 Stone Fire (Figure 4) can be fairly fuel efficient when operated carefully. In the Aprovecho laboratory tests, expert operators tried to get optimal results from each stove. The 3 Stone Fire consumed an average of about 1,100 grams of wood to bring to a boil and then simmer 5 L of water for 45 minutes. In the field, the 3 Stone Fire usually consumes more wood.



Figure 4

optimal results from each stove. The 3 Stone Fire consumed an average of about 1,100 grams of wood to bring to a boil and then simmer 5 L of water for 45 minutes. In the field, the 3 Stone Fire usually consumes more wood.

Six wood-burning stoves in these tests used less fuel to complete the Water Boiling Test. The graph below (Figure 7) details the performance of the wood-burning stoves that used less energy than a 3 Stone Fire. Liquid-fueled stoves and charcoal-burning stoves are included to place the results in a wider context.

The Wood Gas (Figure 5) and Wood Flame (Figure 6) stoves use electric fans to improve combustion efficiency. The low-volume, high-velocity jets of air increase the mixing of gas, air and fire in the

combustion chamber. At the same time, the velocity of hot gases contacting the pot is also increased. Even though the hot gases contact only the bottom of the pot, the two stoves consumed the least wood in these tests. Fans seem to tremendously help wood-burning stoves do well in all categories of performance. Adding a fan to a wood-burning stove seems like a great idea from what we have seen in these tests.

The VITA, Uganda 2-pot, 20 L Can Rocket, and Mud/Sawdust are natural-draft stoves. The velocity of the flame and hot gases is determined by the heat of the fire. In these stoves, the heat is forced to contact the sides as well as the bottom of the pot, so more of the heat from the fire gets into the pot. Luckily for stove builders and designers, the four techniques that help a cooking stove boil water faster also help reduce fuel use.

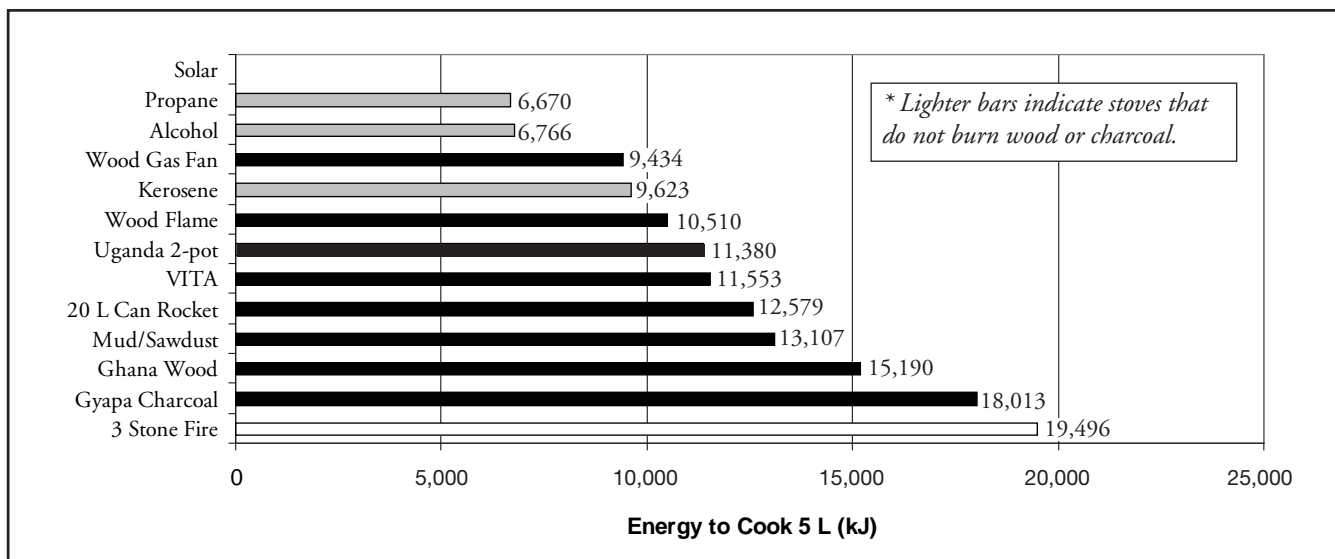

Figure 5



Figure 6

Figure 7 - Stoves that use less energy than the 3 Stone Fire



Why do some stoves emit less carbon monoxide?

Propane is a clean burning fuel that produces a hot, blue flame. Propane is stored under pressure in tanks. When released, the pressure causes mixing of the gas, fire and air, resulting in very little pollution. The alcohol and kerosene stoves in this study were not pressurized and were less successful at reducing harmful carbon monoxide (CO) emissions.

As can be seen in the following graph (Figure 8), two wood-burning stoves equipped with fans were quite successful in reducing the amount of CO. Adding a small electric fan to a wood-burning stove helps in many ways. The jets of hot air create improved mixing that forces the CO to interact with air and flame, resulting in more complete combustion and dramatically reduced emissions of CO.

The Wood Gas stove shoots jets of air into and across the top of the fire, creating a zone in which fuel, air and fire are so well mixed almost complete combustion occurs. The Wood Flame stove blows air up from under the bottom of the fire. It is almost as successful as the Wood Gas stove in reducing CO. Creating a zone of mixing in or above the fire is an effective technique.

Please note that this page references total emissions (PM and CO) produced by the stove, including PM and CO emissions that would normally be exhausted from the house via a chimney not emissions to which the cook is exposed. Many chimney stoves that resulted in very low emissions in the test kitchen emitted high levels of PM and CO as measured under the collection hood from the chimney exit.

Adding an inexpensive fan to a wood-burning stove helps burn wood very cleanly. In many places where biomass fuel is used for cooking, electric power is available. In these locations, wood-burning stoves with fans seem to have a great potential to reduce both fuel use and harmful emissions. The fuel savings and health benefits should far outweigh the cost of the electricity used.

The three T's

Carbon monoxide and particulate matter always form when fuel and air do not completely mix, and complete mixing does not occur in stoves with natural draft. The orange color of a flame comes from the radiation of particulate matter (soot) within the flame. Blue flame results from the reaction of carbon monoxide to produce carbon dioxide. So, colored flames indicate that PM and CO are reacting.

Emissions of these harmful pollutants can be reduced by burning them before the exhaust cools. Wood stove designers know that this burnout requires the three T's: **time, temperature and turbulence**. Time indicates that the longer the exhaust gas stays hot, the longer pollutants have to burn. Temperature indicates that the gas needs to stay as hot as possible; the reactions stop when the gas gets too cool. Turbulence is an engineering term for rough flow. If the air is turbulent, pollutants have a greater chance of coming into contact with oxygen so they can burn out.

Figure 8 - Stoves that emit less CO than the 3 Stone Fire

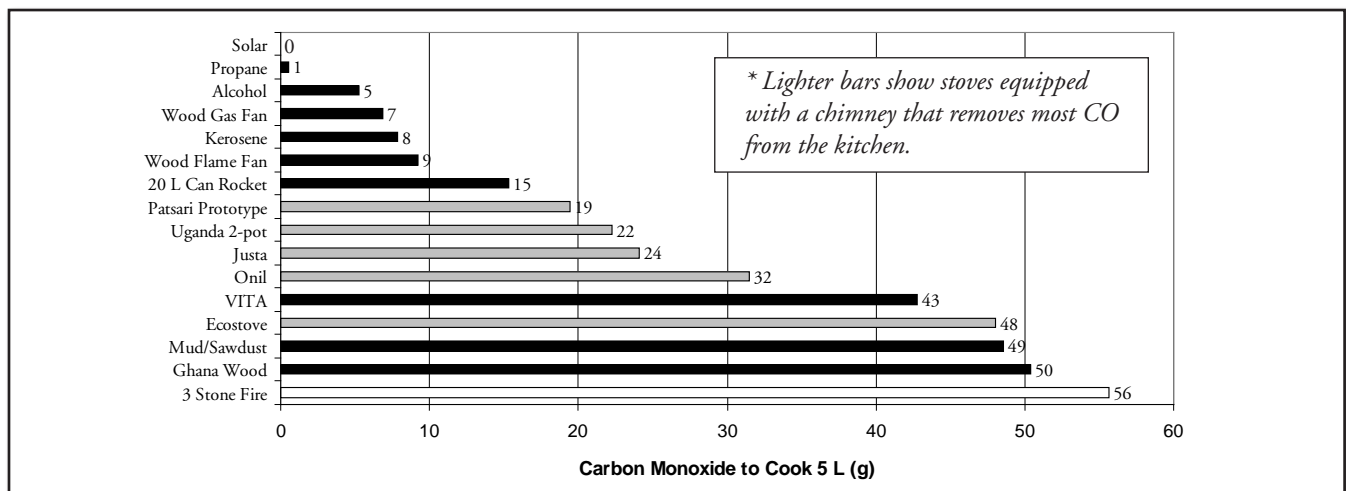

Which wood-burning stoves produce less particulate matter?

Many factors can decrease the emissions of unburned particles. The mixing of hot gases, air, and flame in the Wood Gas and Wood Flame fan stoves dramatically reduces particulate matter (PM) emissions. If electricity is available, biomass stoves with fans, such as propane, alcohol, and kerosene stoves, seem to have a great potential for protecting health by reducing indoor air pollution.

Charcoal-burning stoves made about one-quarter of the PM emissions compared to the 3 Stone Fire in these tests. Although charcoal can produce large amounts of CO, PM emissions were relatively low.

The Uganda 2-pot, Justa, Patsari Prototype, 20 L Can Rocket, and Onil stoves create approximately one-third to one-half the PM made by an open fire. These five stoves have low-mass rocket-style combustion chambers (Figure 9). This type of combustion chamber reduces PM and CO emissions. The VITA and Mud/ Sawdust stoves, on the other hand, are shielded-fire stoves without insulated combustion chambers and do not significantly reduce PM.

Again, adding a fan to a wood-burning stove is shown to clean up combustion. Efficient mixing is responsible for the reduction of PM in the fan and to a lesser degree in the Rocket designs.

Figure 9 - Five stoves with Rocket-style combustion chambers

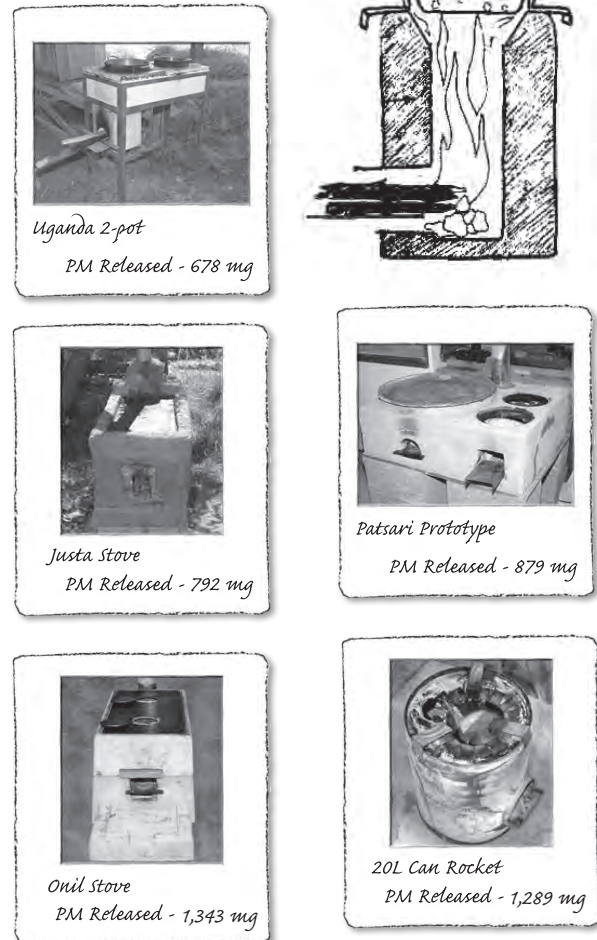

Please note that this page references total emissions (PM and CO) produced by the stove, including PM and CO emissions that would normally be exhausted from the house via a chimney not emissions to which the cook is exposed. Many chimney stoves that resulted in very low emissions in the test kitchen emitted high levels of PM and CO as measured under the collection hood from the chimney exit.

Figure 10 - Stoves that emit less PM than the 3 Stone Fire

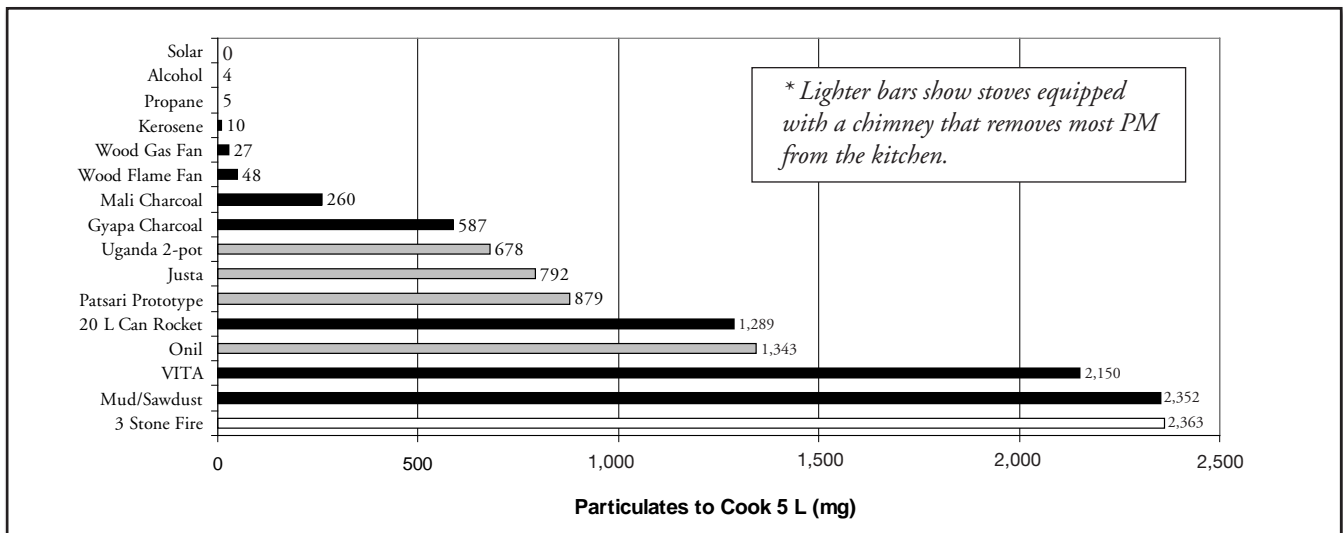

What was the average firepower and turn-down ratio?

Firepower is a measure of how much energy is released each second. More energy is required to quickly boil water than to simmer water. The most effective cooking stove should be fuel efficient at both high and low power operation.

Figure 11 shows the average high firepower for boiling and the low firepower for simmering for each tested stove. It should be noted that in the University of California, Berkeley Water Boiling Test, the pot is uncovered, which increases the energy input needed to maintain the water at three degrees below full boil. The ratio between the high and low firepower (high firepower divided by low firepower) is called the turn-down ratio (TDR). It is a measure of how well the stove can be “turned down” from high to low power.

A TDR of 2 means that half the fuel was consumed while maintaining a simmering temperature, compared to the amount of fuel used to bring the water to boil. Cooks usually appreciate a stove that is capable of both high-and low-power operation. Many foods will burn if the firepower cannot be sufficiently decreased.

It is interesting to note that the liquid-fueled stoves were generally low powered and used nearly the same energy to boil and simmer food. The Mud/Sawdust (TDR 3.9) and VITA (TDR 3.8) stoves had the highest TDR. The average for the other wood-burning stoves without chimneys was 2.4. The average for stoves with chimneys was 2.2. The Gyapa charcoal stove (TDR 2.8) scored slightly higher. While TDR seems to be an important stove characteristic, the graphs on the following page (Figures 12 and 13) indicate that TDR alone does not predict fuel efficiency.

Figure 11- Firepower and turn-down ratio of stoves

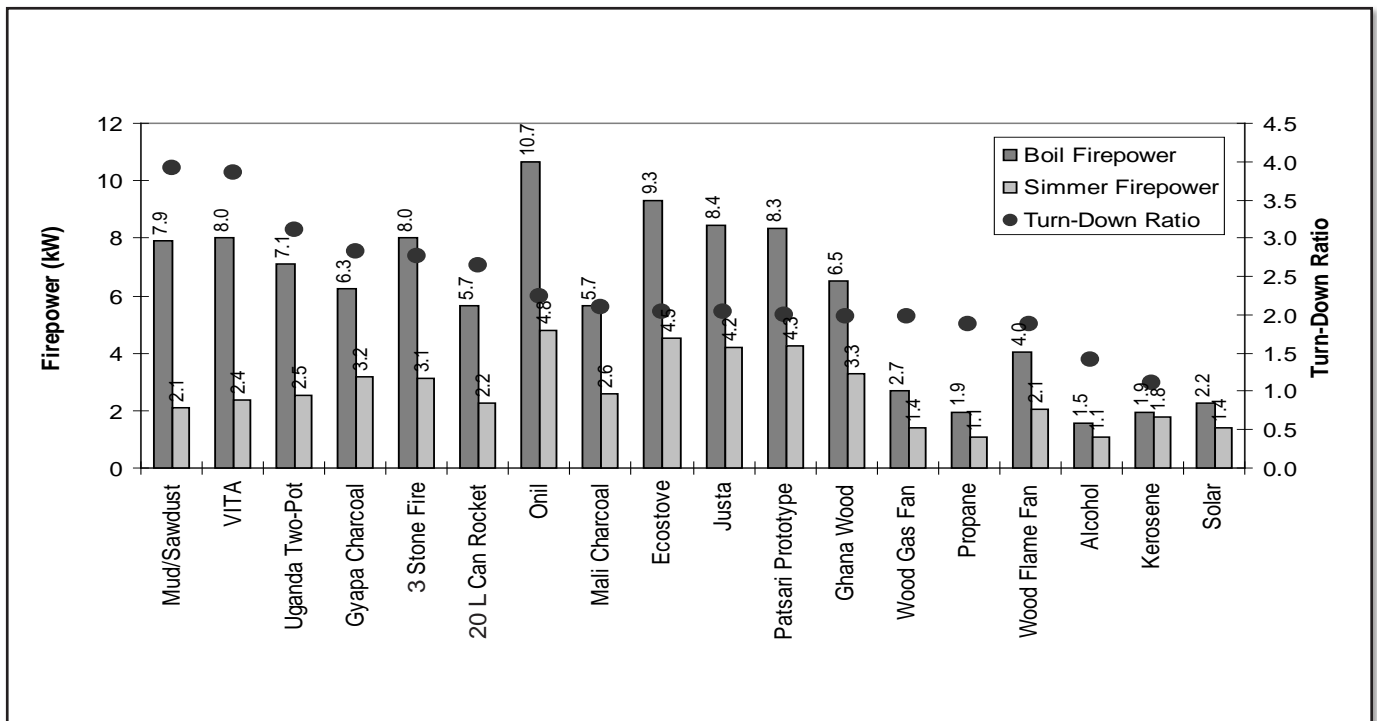

Figure 12- Energy to cook vs. turn-down ratio

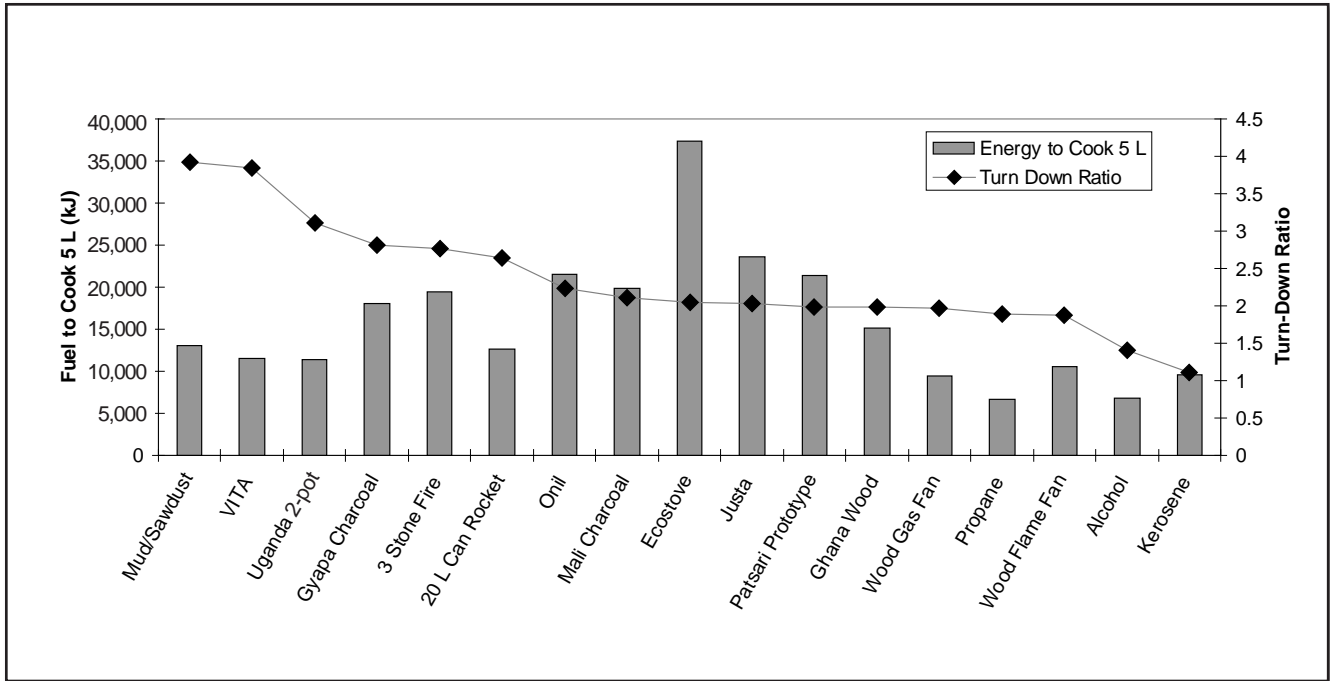
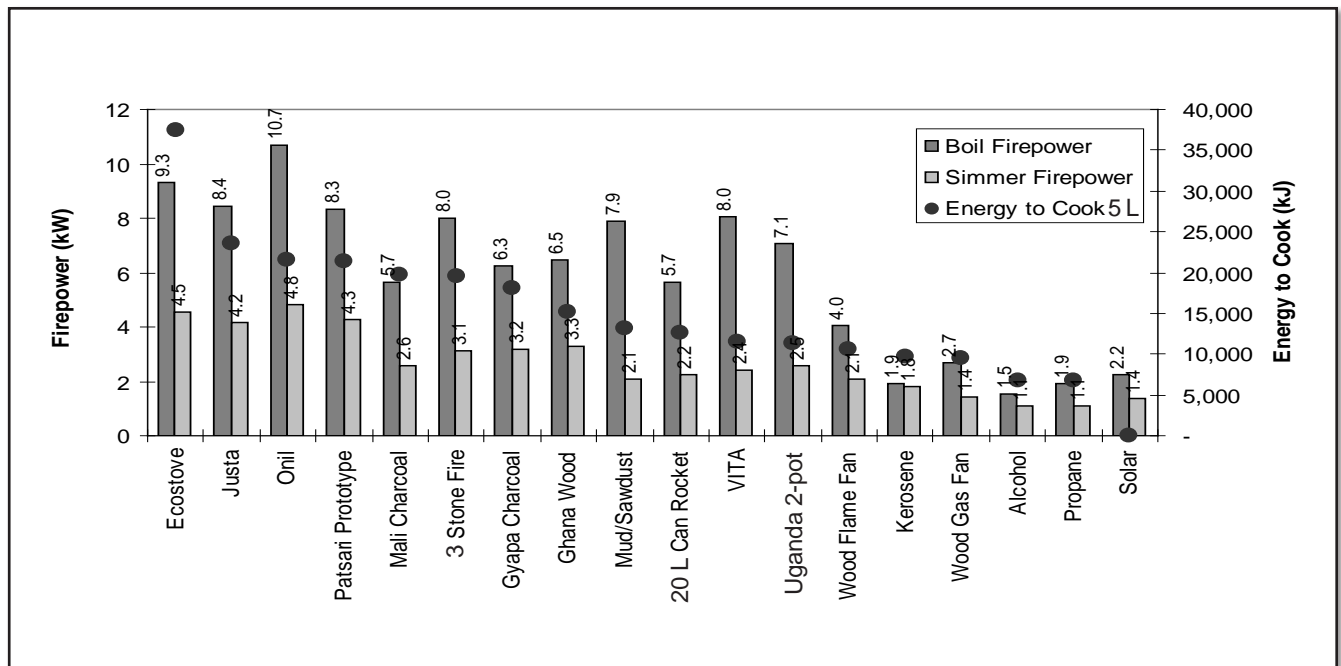

Figure 13- Firepower of stoves and energy to cook 5 L



What is the effect of adding a chimney to a wood-burning cook stove?

Chimneys protect the cook and family from smoke. The chimney has evolved over time to be the primary solution to indoor air pollution. If the stove and chimney do not leak, pollution is removed from inside the house. In these experiments, chimneys protected the testers from the dangerous levels of indoor air pollution made by fire. A functional chimney can remove essentially all the emissions made inside a stove, if the smoke does not leak into the room.

Figures 16 and 17 compare the performance of stoves with and without chimneys. Chimneys removed all but 1% of the CO and PM from the test kitchen. The pollutants that did enter the kitchen escaped through small leaks in the stove.

The stoves with chimneys in this study were slower to boil water and used more wood to boil and then simmer water (Figure 14). However, these stoves were mostly griddle stoves in which hot gases transfer heat through a heavy metal surface to the pots or food placed directly on the griddle. It was the griddle that caused these differences, not the chimney.

Figure 14- Comparison of non-chimney and chimney stoves

	Average No Chimney	Average Chimney
Time to Boil	19 min	33 min
Fuel to Cook	870 g	1,400 g
CO in Kitchen	340 ppm	3 ppm
PM in Kitchen	18,000 μm^3	280 μm^3

Griddle stoves such as the Justa, Onil and Ecostove have a great advantage in that food can be cooked directly on the hot surface. The griddle stove is necessary and popular in places where flat breads are cooked. In Central America tortillas are a staple food. As the tortillas are made, a pot of beans often simmers to completion at the back of

the griddle. The griddle stoves in this study all had chimneys that removed essentially all emissions out of the kitchen.

As can be seen in Figure 17, stoves without chimneys often created dangerous levels of pollution in the test kitchen.

The Uganda 2-pot stove (Figure 15) is the only stove equipped with a chimney studied in which pots are submerged into the stove body. It does not have a griddle. Instead, the hot gases flow against the bottom and sides of the two submerged pots, which fit tightly in holes that prevent smoke from escaping into the kitchen. As can be seen in Figure 16, the Uganda 2-pot chimney stove boils water as quickly and uses about the same amount of fuel as stoves without chimneys. Stoves without chimneys are shown on the left side of the graph, while those with chimneys are on the right.

Lacking a sealed griddle, the Uganda 2-pot stove leaks more pollution into the room than do other stoves equipped with chimneys. However, the levels of indoor air pollution are greatly reduced compared to a 3 Stone Fire. If the stove had better seals around the pot, more of the smoke would exit the chimney.



Figure 15

Figure 16 - Chimney stoves: fuel to cook and time to boil

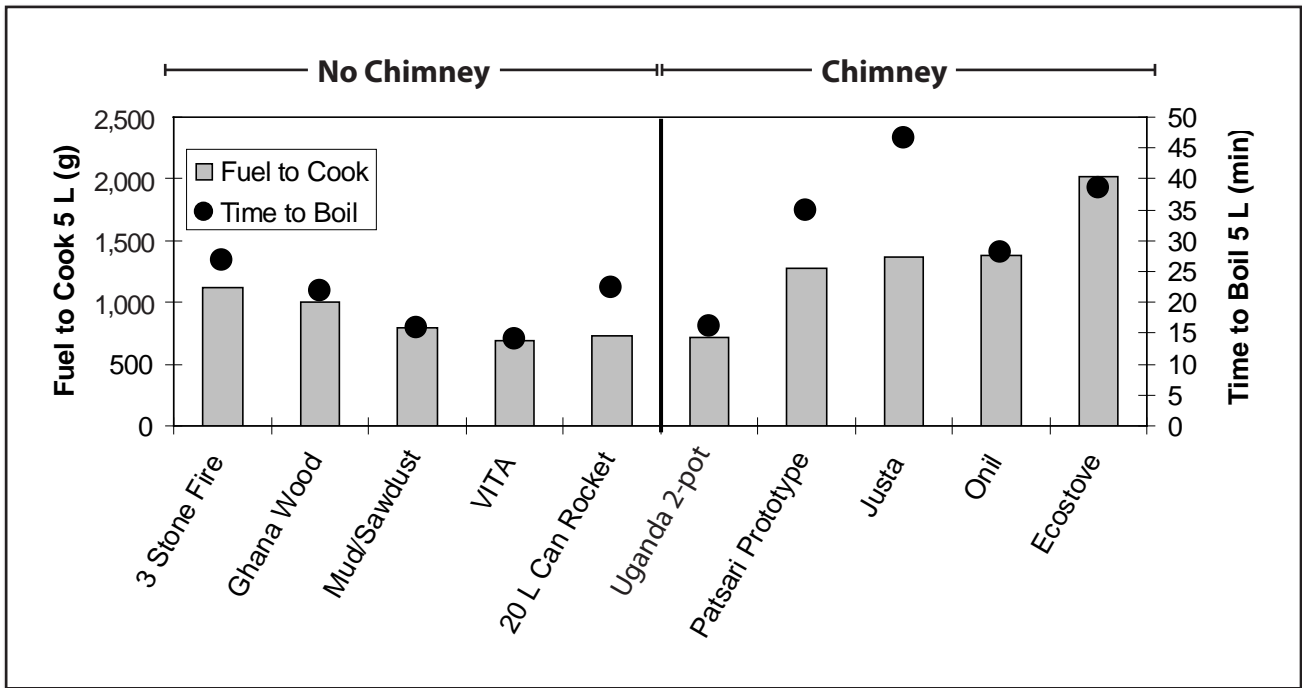
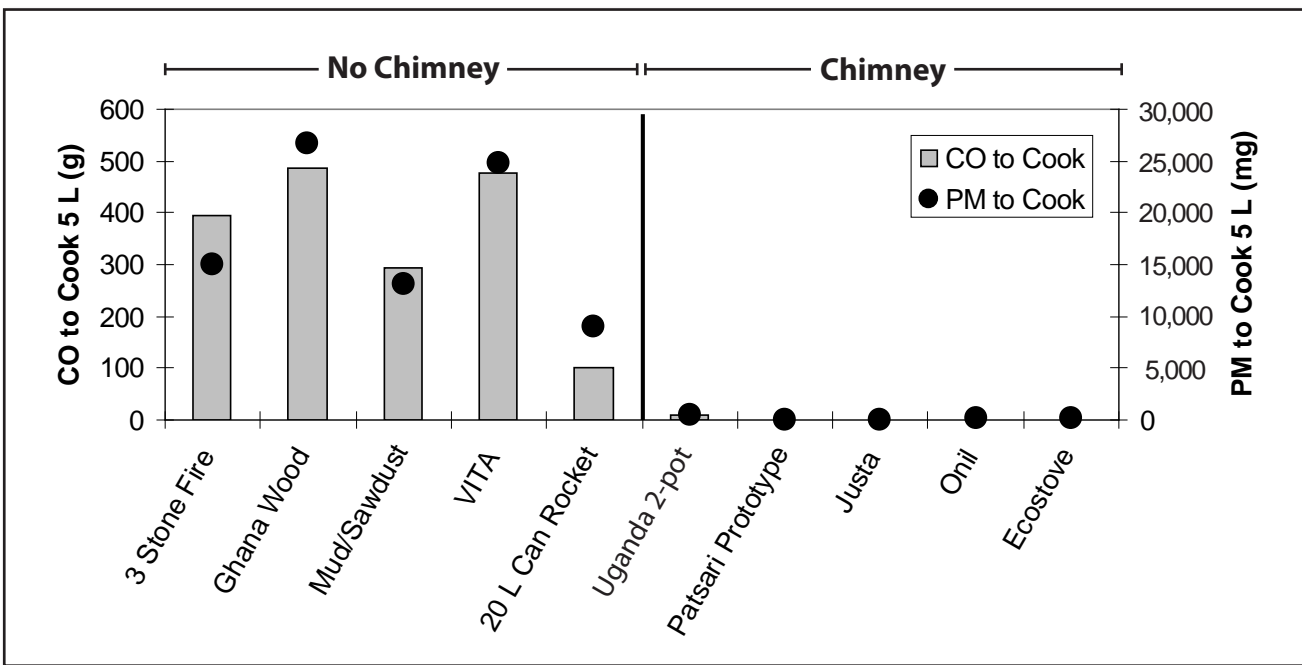

Figure 17 - Chimney stoves: kitchen emissions to cook 5 L



How does ventilation affect pollution in a kitchen?

To make all the tests as similar as possible, the test kitchen doors and windows were closed when the stoves were being tested and testing was done only on calm days. If the wind was blowing one day and not the next, the levels of CO and PM measured in the building would be affected, making accurate comparisons difficult. Tests were conducted to determine whether opening the door or window, or making a small hole in the roof, would significantly reduce the indoor air pollution. The tests described here explore this question.

In this study, 20 Kingsford charcoal briquettes were burned in the approximately 15-cubic-meter test kitchen with approximately 3 air exchanges per hour. The emissions-monitoring equipment consisted of six HOB0 carbon monoxide monitors and two Airmetrics Minivols pump and filter particulate meters. The Minivol draws 5 L of room air per minute through a filter that collects PM2.5 (particles less than 2.5 micrometers in aerodynamic diameter).

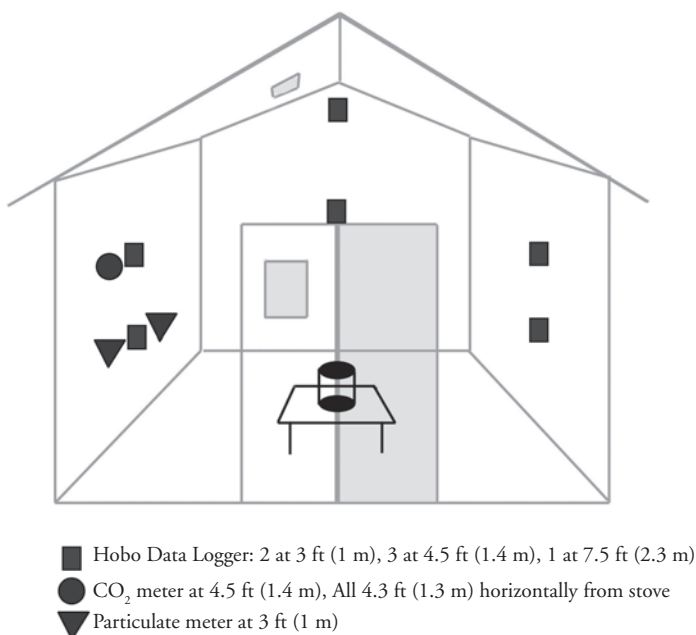

Figure 18 - Test kitchen diagram

Three tests were performed for each configuration:

1. The window, door and hole in the roof closed.
2. The 0.6 by 1.8 m door open.
3. A 20 by 25 cm hole in the roof open.
4. A 28 by 36 cm window, along with the 20 by 25 cm hole in the roof, open.

The kitchen diagram (Figure 18) shows the location of openings as well as the placement of monitoring equipment.

The charcoal was left to burn vigorously for 30 minutes. It was then quickly removed through a small opening, which was then closed. The test continued for another 30 minutes as levels of CO and PM declined.

Figure 19 shows the peak concentration of CO reached after the half hour of burning, the average CO level throughout the test, and the average concentration of PM during the four levels of ventilation. As Figure 19 shows, increasing amounts of ventilation significantly lowered levels of both types of emissions.

Figure 20 summarizes the variability and potential reduction in indoor air pollution resulting from the four configurations. The levels of both CO and PM with the door and window closed were elevated, as can be expected. Opening the door was highly effective in this study, reducing emissions by 96%.

Making a small hole in the roof also significantly improved air quality. However, simultaneously

Kitchen Dimensions:	
10 ft (3 m) wide X 8 ft (2.4 m) deep X 6 ft (1.8 m) high X 8 ft (2.4 m) peak	
Door: 2 ft (0.6 m) X 6 ft (1.8 m)	
Window: 11 in (0.28 m) X 14 in (0.36 m)	
Hole in Roof: 9.8 in (0.25 m) X 7.9 in (0.2 m)	
Stove height: 2 ft. (0.6 m)	

Figure 19 - CO and PM in the test kitchen with differing ventilation

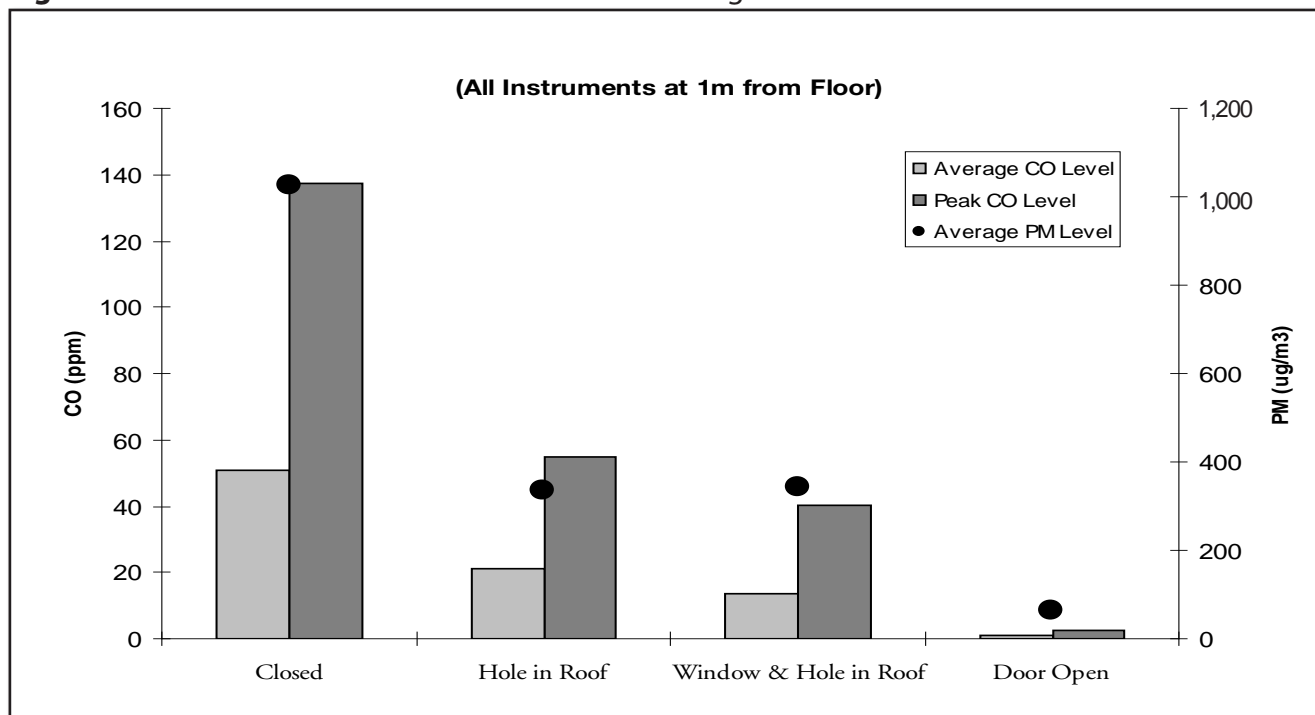

opening a small window did little to further reduce levels of pollution, possibly because the window did not add much flow to the movement of CO and PM through the smoke hole in the roof.

Increasing ventilation seems to be an effective strategy for decreasing indoor air pollution in

houses in which biomass fuel is burned. Increasing ventilation dramatically reduced both CO and PM in the test kitchen. Opening the door was especially effective. Cutting a small, covered hole in the roof also removed most of the smoke from the kitchen because the smoke collects near the ceiling in a room.

Figure 20 - CO and average PM level reduction by ventilation

		Average	% Reduction from Closed Kitchen	Expected IAP Reduction for This Ventilation
Closed Kitchen	CO Average (ppm)	54		
	CO Peak (ppm)	160		
	PM Average (ug/m ³)	1,025		
Hole in Roof	CO Average (ppm)	18	67%	
	CO Peak (ppm)	41	75%	
	PM Average (ug/m ³)	334	67%	70%
Window and Hole in Roof	CO Average (ppm)	14	75%	
	CO Peak (ppm)	44	73%	
	PM Average (ug/m ³)	345	66%	71%
Door Open	CO Average (ppm)	1	97%	
	CO Peak (ppm)	6	96%	
	PM Average (ug/m ³)	66	94%	96%

Natural ventilation is driven by air pressure due to differences in air density. If indoor air is warmer than outdoor air, the flow out of the hole in the roof can be increased. To some extent, this stack effect depends on winter and summer temperatures.

Stratification of CO and PM in the test kitchen (See Figure 21)

Three additional tests were run to study stratification in the closed kitchen using six HOBO CO data loggers and six Minivol PM monitors at three different heights on opposite sides of the room. The HOBOS and Minivols were located across from each other at 1 meter, 1.4 meters and 1.8 meters above the floor.

Both CO and PM stratified by height in the test kitchen, collecting densely at the ceiling and decreasing gradually towards the floor. Levels were lowest nearest the floor, suggesting that exposure could be reduced by sitting instead of standing while cooking. Some horizontal stratification was also observed.

Figure 21- CO and PM concentrations by height across the unventilated kitchen

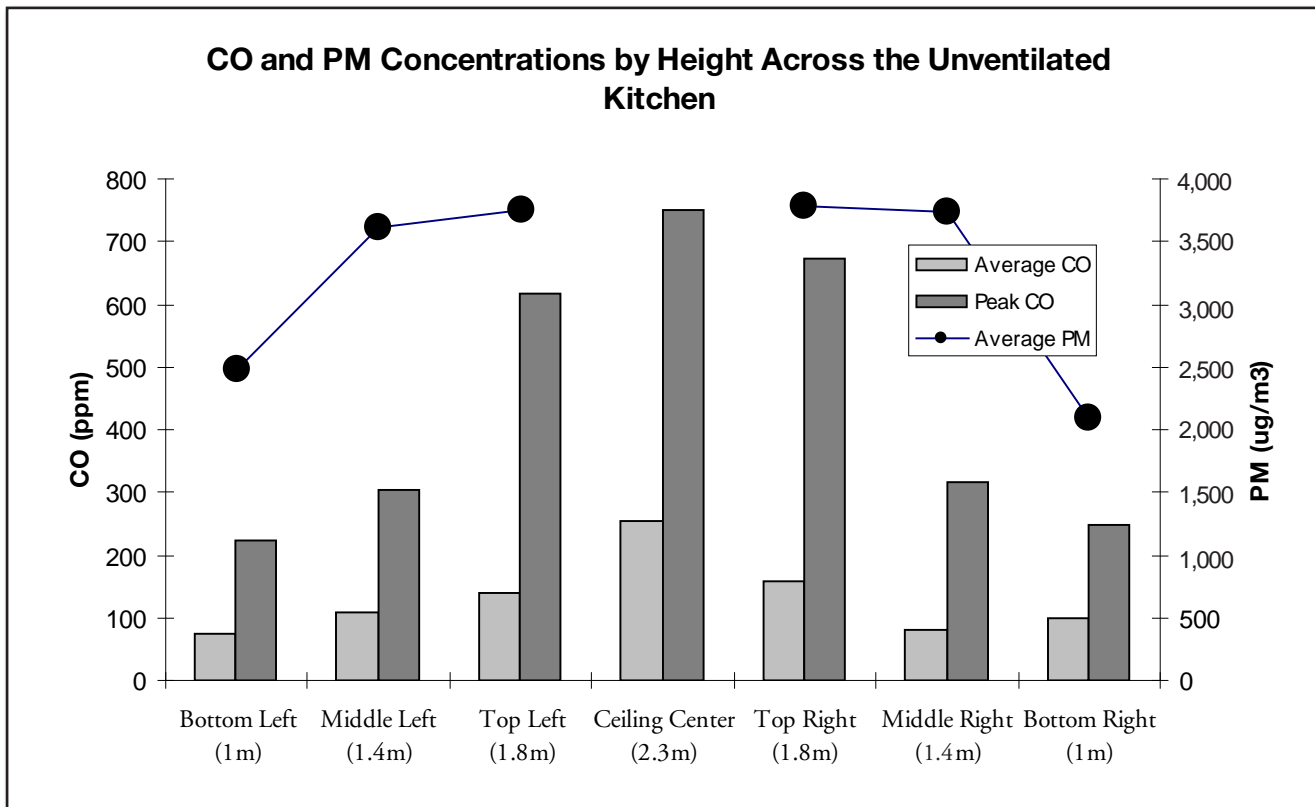

How do fans improve wood-burning cook stoves?

As can be seen in Figures 22 and 23, wood-burning cook stoves equipped with fans have several advantages. In natural-draft stoves, smoke, air and flame are not forced to mix; smoke can go in one direction and flame can go in another. The smoke can easily escape combustion, so CO and PM emissions are often high. The averages of CO and PM in the test kitchen and under the emissions hood are dramatically reduced when a fan is used.

In the Wood Gas fan stove (Figure 24), jets of air are blown into and over the fire. The Wood Flame fan stove (Figure 25) blows jets of air only into the fire from under the floor of the combustion chamber. The two stoves used an average of 540 grams of wood to boil and then simmer 5 L of water for 45 minutes. The average stove without a fan used 870 grams of wood to accomplish the same task. The velocity of hot gases and possibly gas temperature are increased by the jets of air. Radiation to the pot can also be increased in a fan stove because the distance between the fire and the pot is usually reduced. For these reasons, the heat transfer to the pot is increased and less wood is needed for cooking.

Although the hot gases contact only the bottom of the pot in the Wood Flame and Wood Gas stoves, the fuel used to boil and simmer water is less than the VITA, Mud/Sawdust and 20 L Can Rocket stoves, even though these natural-draft stoves all force the hot gases to flow against the sides of the pot after contacting the bottom. The fan increases both heat transfer and combustion efficiency.

Stoves with fans are remarkably clean burning (see Figure 26). Even though the 20 L Can Rocket stove is considered a “clean-burning” wood stove, the fan stoves are much cleaner because the production of PM and CO is considerably reduced. A stove equipped with a chimney or a fan can reduce emissions and exposure to pollutants while cooking with wood.

Figure 22 Fan stoves fuel to cook and time to boil 5 L

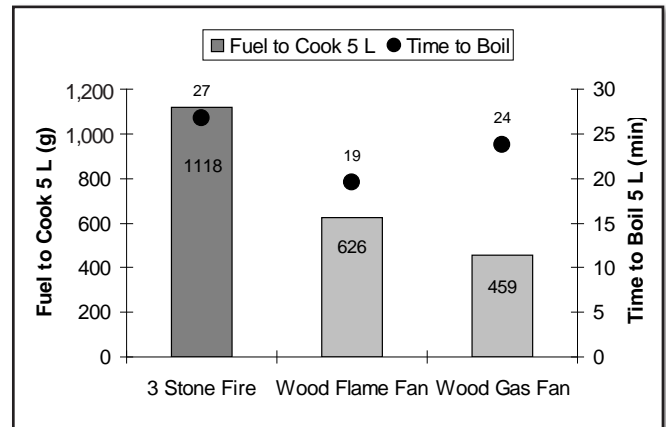

Figure 23 Fan stoves CO and PM emissions to boil 5 L

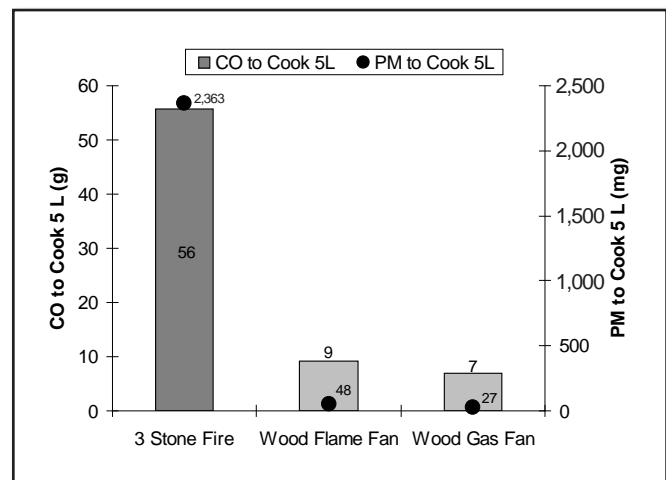

Figure 24



Figure 25



Figure 26 Comparison of stoves with and without a fan

	Average of No Fan Stove	Average of Fan Stove	Fan/No Fan
Time to Boil (min)	19	22	117%
Fuel to Cook (g)	870	540	63%
CO in Kitchen (ppm)	340	90	27%
CO under hood (ppm)	43	8	19%
PM in Kitchen (ug/m ³)	18,000	2,200	12%
PM under hood (ug/m ³)	2,500	37	1%

How do wood- and charcoal-burning stoves compare?

The charcoal used in this study was made in Mexico from the trunks and branches of mesquite trees. Two charcoal-burning stoves were tested, one from Mali (Figure 27) and one from Ghana (Figure 28). In these tests fuel use and emission measurements began 10 minutes after the charcoal was lit. The two stoves were found to be more effective than traditional charcoal-burning models studied in previous tests.

Charcoal is made by heating wood or other biomass fuel inside a relatively air-tight enclosure, such as an earth covered pit in the ground. Smoke escapes through holes in the covering



Figure 27



Figure 28

and causes air pollution. In this case, wasted smoke is fuel that could have been used to cook food. However, there are more efficient methods of producing charcoal that can avoid energy losses. Examples include producing charcoal in stoves that burn the volatiles in biomass to produce heat for cooking and producing charcoal from crop residues that otherwise would be burned. Between 70% and 80% of the energy in wood is used to produce charcoal.⁵ “The charcoal thus produced retains the same shape of the original wood but is typically just one-fifth the weight, one-half the volume, and one-third the original energy content.”⁶

Figure 29 compares the energy in charcoal and wood fires. Since so much energy is lost when making charcoal, wood stoves were much more fuel efficient. Almost three times as much total energy was used to cook food with the charcoal stoves in these tests.

As can be seen in Figure 30, the two charcoal stoves boiled water slower than the 3 Stone Fire and the average of all single-pot, wood-burning stoves. Charcoal seems especially well suited to simmering, but is somewhat low powered for rapid boiling.

⁵ Aprovecho/GTZ. (1984). Charcoal: small scale production and use.

⁶ Baldwin, S./VITA. Biomass stoves: engineering design, development and dissemination. Princeton University, 1986. P13.

Figure 29 - Charcoal comparison: Energy used to cook 5 L

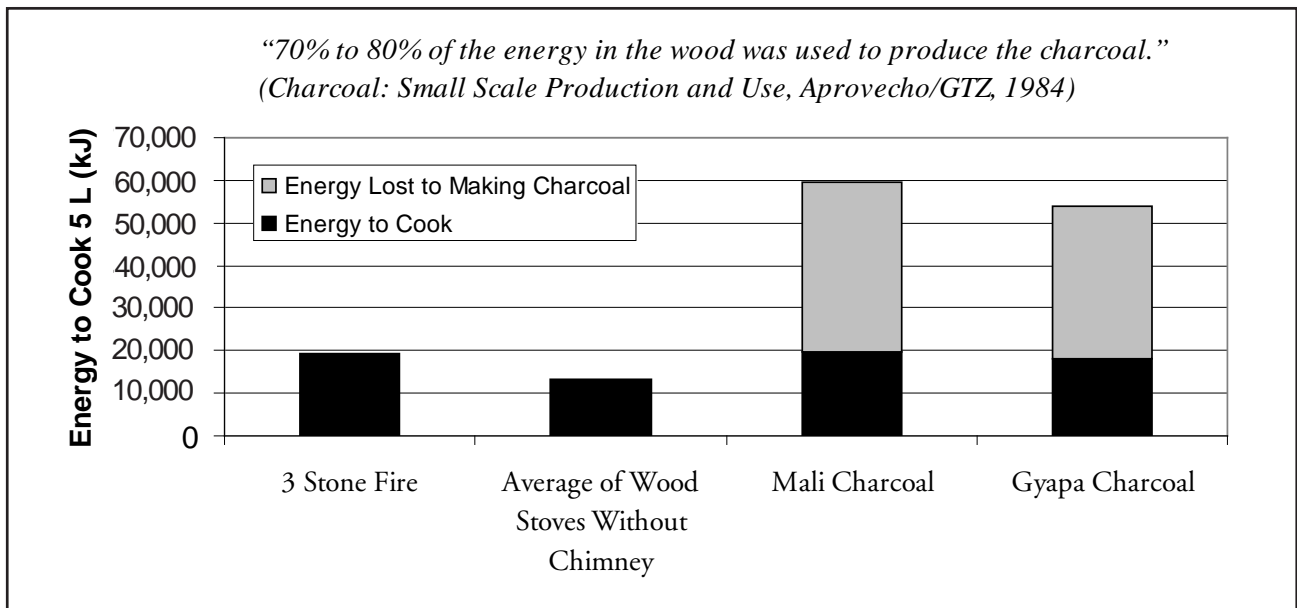

The great advantage of charcoal is that it continues burning at a steady rate, without the need to constantly feed the fire, as in a wood-burning stove. Reducing the air entering the fire prolongs the useful cooking time and provides a gentle heat suited to simmering.

Charcoal is known to produce a large amount of CO. In these tests was certainly true. Charcoal stoves produced at least twice as much CO as any other stove. On the other hand, PM from charcoal-stove emissions was low, especially during simmering. The significant reduction in PM when using charcoal could help reduce human health impacts, except that CO emissions are so high (Figure 31).

Figure 30 - Charcoal comparison: Time to boil 5 L

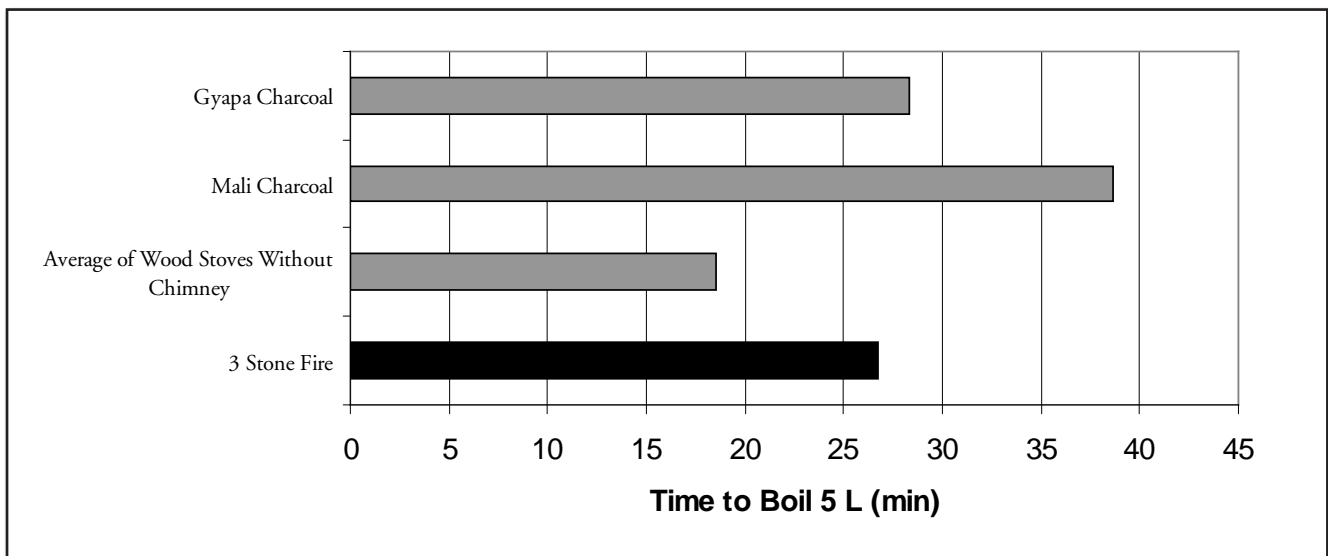
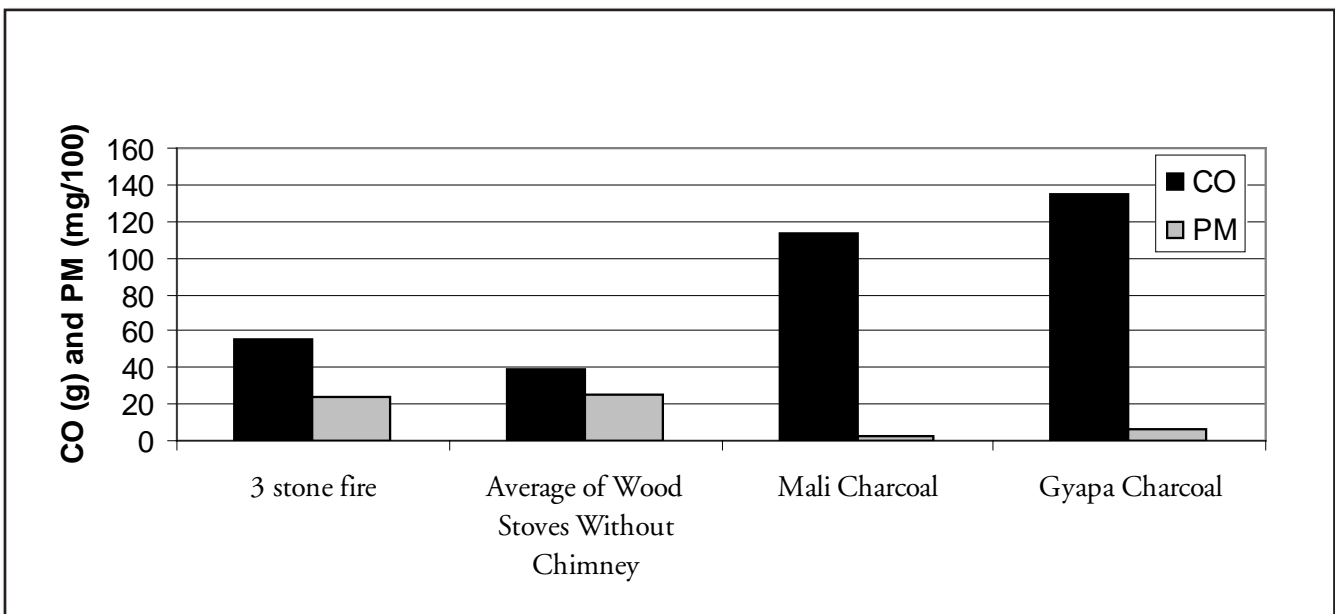

Figure 31 - Charcoal comparison: CO and PM emissions to cook 5 L



How does a retained heat cooker help when cooking?

When food simmers, the fire replaces the constantly lost heat from the pot. If the heat were not lost but captured instead, then less fuel would be needed for cooking. Placing the pot of boiling food in an insulated container keeps the food hot enough to simmer it to completion. In the same way, a drafty and uninsulated house has to have a big fire in the heating stove going all the time to keep the house warm. Even if no fire is lit, the super-insulated, almost airtight house can stay warm for a long time.

After a pot of food boils, the contents are close to 100° C. When the hot pot is placed in a super-insulated, almost airtight box, the food finishes cooking, because the stored heat stays in the food. Once the pot is in the box, food cooks without further attention. The retained heat cooker (RHC) or Haybox as it is called in some parts of the world, saves time, effort, and fuel, freeing the cook from long hours of watching the slow fire when simmering food.

Figures 32 and 33 depict both time and fuel savings when using a retained heat cooker to simmer food. Approximately 50% savings in both categories can be expected.

Figure 32 - Use of the RHC potentially saves time tending the stove during simmering

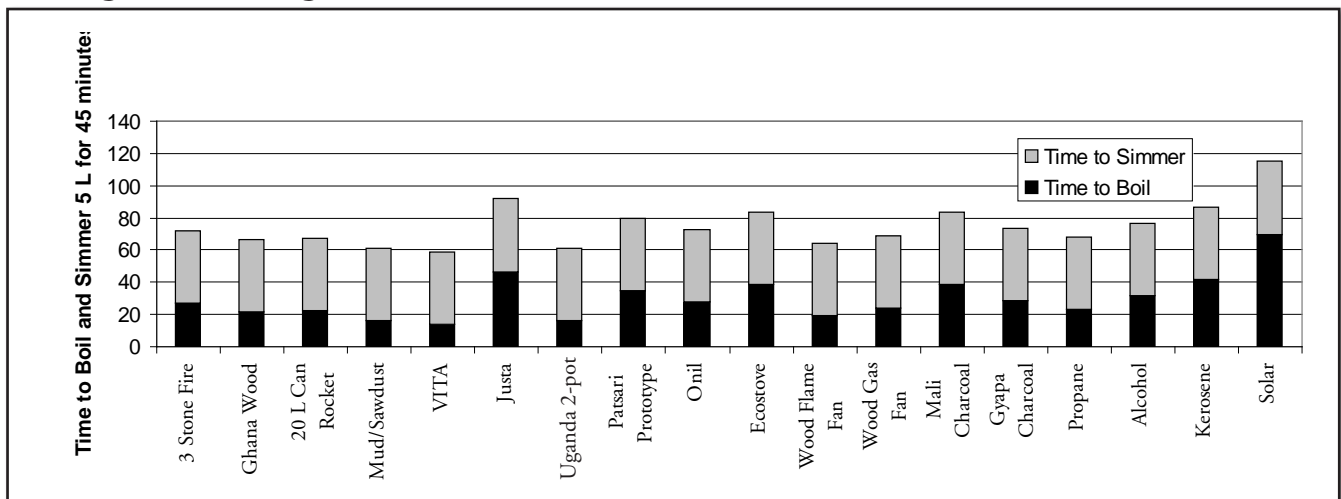
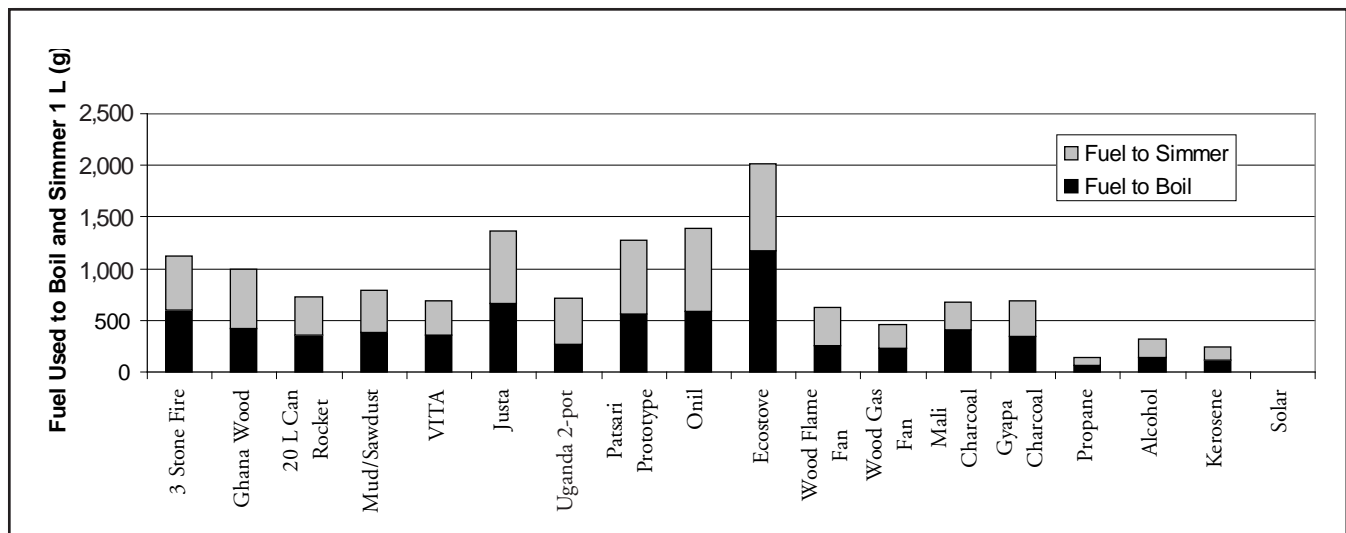

Figure 33 - Use of the RHC potentially saves fuel during simmering



Because the fuel is initially used only for boiling food, cooking with an RHC creates much less pollution, helping to clean up the air in the kitchen. In these tests, using an RHC reduced, on average for all stoves, CO emissions by 56% and PM emissions by 37% (Figures 34 and 35).

other tasks. The attraction of the RHC begins with its convenience. The fuel savings and decrease in harmful emissions add to the benefits of retained-heat cooking. More information on Retained Heat Cookers can be found in PCIA's *Guide to Designing Retained Heat Cookers* available at www.PCIAonline.org/resources.

RHCs have been used for hundreds of years. They can save time and effort which can be devoted to

Important Note!

Food should be boiled for at least 5 minutes to kill bacteria before being placed in a retained-heat cooker.

Figure 34 - Potential PM emission savings using an RHC during simmering

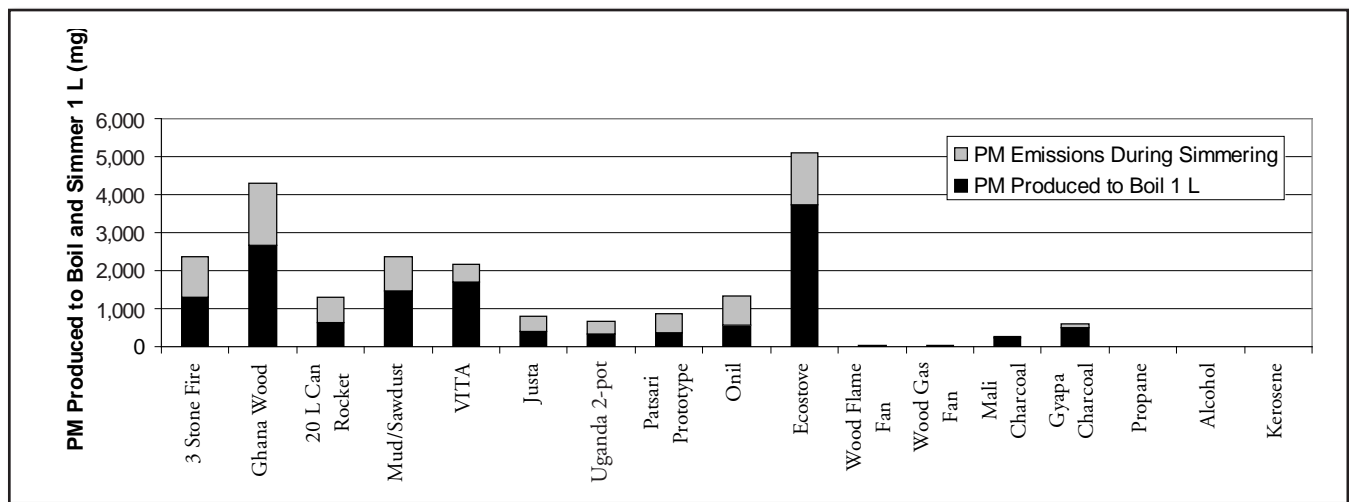
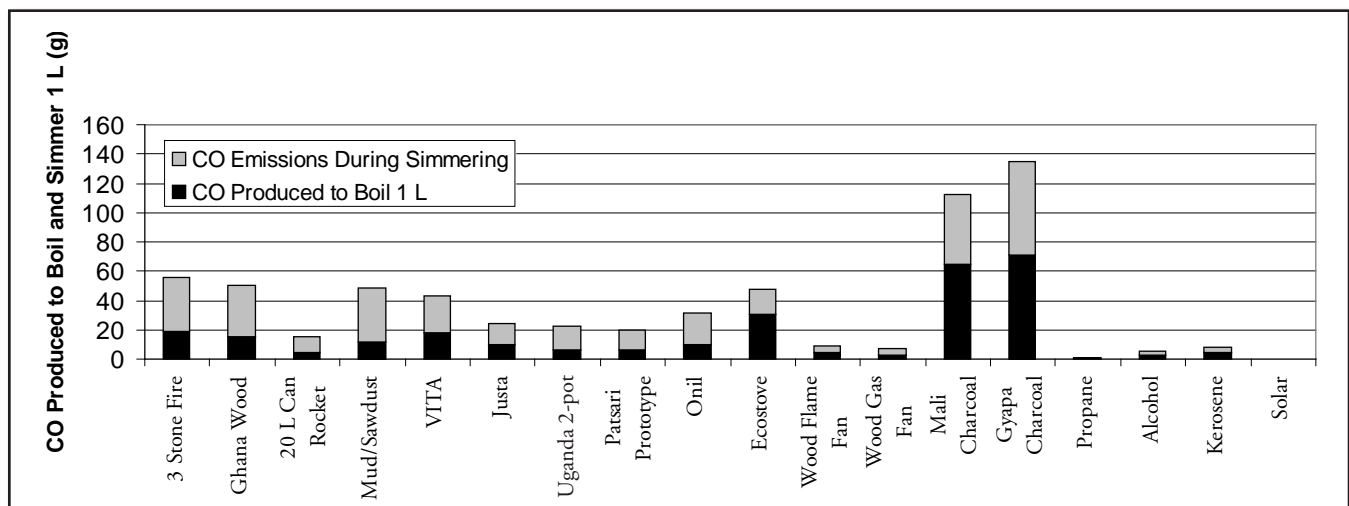

Figure 35 - Potential CO emissions savings using an RHC during simmering



What is efficiency?

People are naturally drawn to the word “efficiency” and think that improved thermal efficiency means decreased fuel use when cooking food. Unfortunately, choosing a stove based on thermal efficiency can result in the selection of a stove that is not necessarily as fuel saving as possible.

Thermal efficiency is a measure of how much energy in the wood fuel is transferred into the cooking pot. Because there is no good way to measure this heat transfer, it is often approximated by measuring the amount of water evaporated; but this technique does not indicate how much of that energy is useful for cooking. Boiling off a lot of extra steam can result in a higher “efficiency” number, but it will not cook food any faster than a more moderate rate of simmering.

A water-boiling test is usually used to determine efficiency. There are many versions of water-boiling tests. Varying test methods result in numbers for efficiency which are not readily comparable. An alternative approach called “specific consumption” replaced efficiency in the 1985 VITA International Testing Standard.

Specific consumption is the fuel used per unit of product produced. The unit of product could be bowls of cooked food and or loaves of bread. In this case, liters of boiled and simmered water represent cooked food. Remember that we are talking about the weight of finished product (cooked food, or in this case, water remaining at the end of the test), not starting weight (uncooked food, or in this case, water at the beginning of the test).

Figures 36 and 37 rank the energy and fuel used by different stoves to do the same task (producing a liter of boiling water, then simmering it for 45 minutes). The efficiency of the stoves is represented by the line. It can be seen that the two measures of stove performance are not closely related. “Thermal efficiency” rewards the production of excess steam, while “specific consumption” penalizes it. Making excess steam results in less final product and is not needed for fuel-efficient cooking. The VITA 1985 International Testing Standard recommends “Specific Consumption” as the more reliable indicator of stove performance.

Figure 36 - Comparison of specific energy consumption and thermal efficiency to boil 1 L

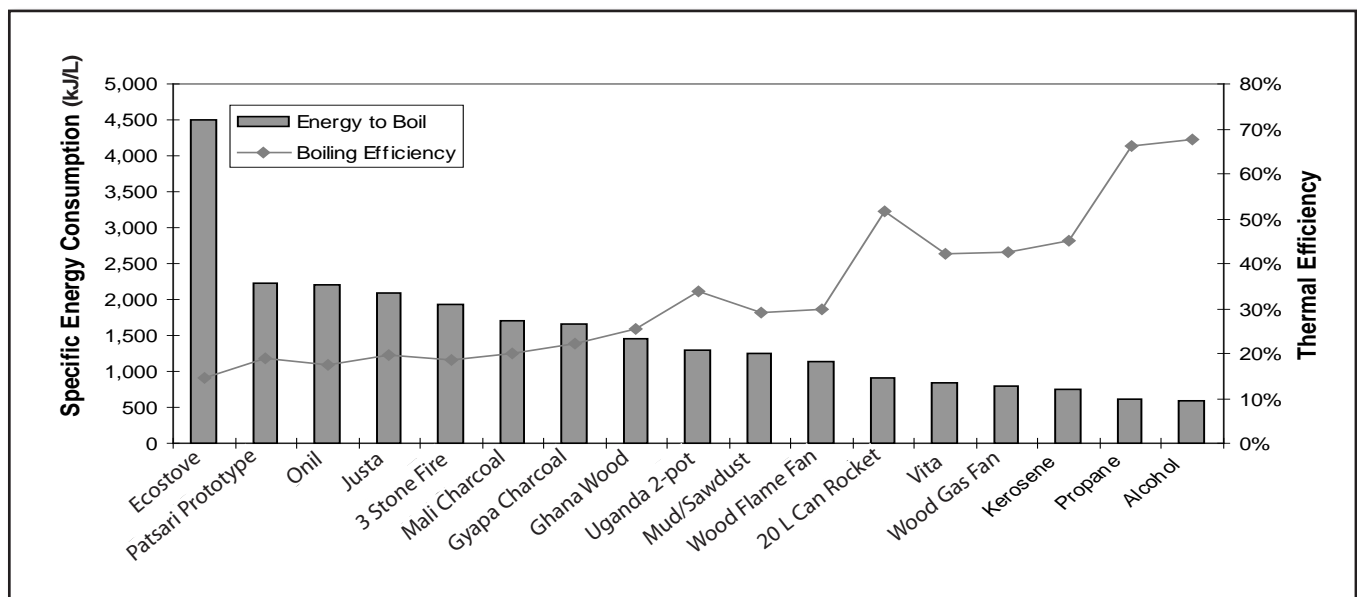

Stove power must be sufficient to overcome heat losses through the sides of the pot and to supply the heat required for vaporization of water. As the water approaches the boiling point, more power is needed to offset heat losses from the pot. This high-energy requirement is difficult for low-powered stoves to meet, and they remain in the pre-boiling state longer than high-powered stoves. At near-boiling temperatures, a lot of water evaporates. For this reason, low-powered stoves can evaporate more water than high-powered stoves before they reach a boil. However, this condition may not be efficient because the stove is struggling to reach the boiling point.

The requirement for more energy as the boiling point is approached creates an energy “hump” which low-powered stoves take longer to overcome. The low-powered stove boils off a great deal of water because the water remains in the high steam-making condition longer than the higher powered stove. This condition results in long times to boil and large losses of water through vaporization. Increased steam production can produce high efficiency numbers even though fuel is being used for a longer period.

Problems with efficiency become even more evident when simmering water. Simmering attempts to maintain hot water (or food) at just under the boiling temperature, using the minimum amount of fuel. The most effective methods for simmering water (such as the use of pot lids, insulation, retained-heat cookers, etc.) cannot be measured by the method of estimating heat transfer from steam loss.

Problems with thermal efficiency have been recognized for decades. Thermal efficiency in conjunction with power output (at high and low power) can be used to make accurate predictions about stove performance. By using the two factors together and defining a cooking process (cooking rice, for example), one can calculate cooking time, fuel use, water loss and so forth. However, thermal efficiency by itself is not a reliable predictor of performance and should only be used with other measures, such as specific consumption, when comparing cook stoves.

Figure 37 - Comparison of specific energy consumption and thermal efficiency to simmer 1 L

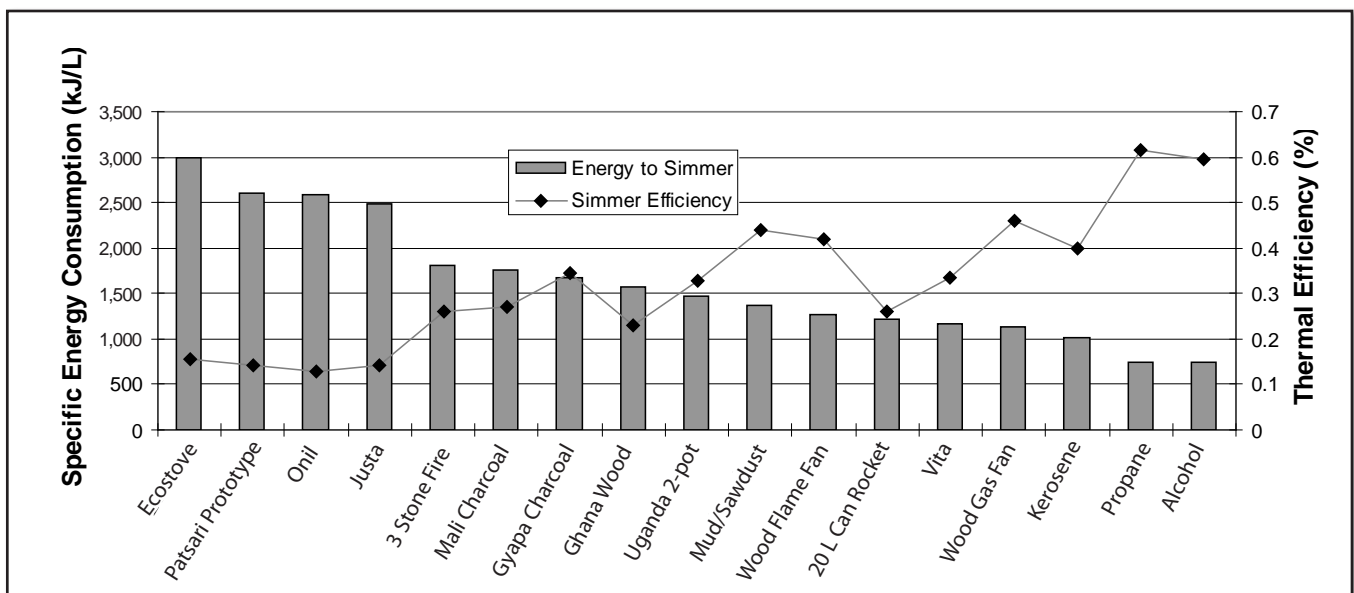

Does increasing heat transfer efficiency have to decrease combustion efficiency?

Dr. Grant Ballard-Tremeer⁷ and Dr. Kirk Smith have pointed out that getting more of the heat from a fire into the pot can also result in more pollution. For example, lowering a pot closer to the fire results in lower fuel use but also makes more smoke. Smith summarized this observation as follows:

“Combustion efficiency (CE) may not be worth pursuing from an overall efficiency (OE) standpoint, but is very much worth pursuing from a pollution standpoint because pollution emissions are a direct function of (1-CE). Thus, a relatively slight lowering of CE, which may produce only a slight change in OE, can produce substantial increases in pollution, even on a per meal basis.”⁸

Smith lists examples from his studies where small decreases in combustion efficiency, following changes to increase heat transfer efficiency, resulted in two to three times more pollution per meal. Is it always true that getting more of the heat from a fire into the pot results in poorer combustion and more smoke?

Dr. Larry Winiarski⁹ approached designing stoves by separating functions along the same lines as Ballard-Tremeer and Smith. His hope was that if wood were burnt in an improved combustion chamber, cleaner hot gases could be forced to flow against the pot without making more smoke. Winiarski hoped that if CE was close to 100%, improving heat transfer efficiency (HTE) would not decrease combustion efficiency.

Figure 38 shows examples where increasing HTE does decrease CE. Emission factors are useful to compare because emission factors report the mass of pollution per mass of wood burned, indicating the cleanliness of combustion. As can be seen, the Mud/Sawdust stove and especially the VITA stove sacrifice clean burning for reduced fuel use and quicker time to boil. However, neither of these stoves has an improved combustion chamber.

In the VITA and Mud/Sawdust stoves, the fire is surrounded by a metal or earthen wall and moved closer to the pot. In both stoves, small channels force the hot gasses to also flow against the sides of the pot. This type of stove can make more pollution per meal because it does not address combustion efficiency.

Figure 38 - Comparison of specific energy consumption and thermal efficiency to simmer 1 L

	3 Stone Fire	Mud/Sawdust	VITA	20 L Can Rocket
Time to Boil (min)	27	16	14	22
Fuel to Cook (g)	1,100	780	690	730
CO to Cook (g)	56	49	43	15
PM to Cook (g)	2,400	2,400	2,200	1,300
Emission Factor CO (g/kg)	51	43	93	14
Emission Factor PM (mg/kg)	3,500	5,100	8,300	2,000

⁷ Dr Ballard-Tremeer graduate thesis. (1997). See <http://ecoharmony.com/thesis/PhDintro.htm>.

⁸ REPP Stove List, May 2002

⁹ Dr. Winiarski *Capturing Heat I* (Aprovecho Research Center, 1996).

Winiarski’s 20 L Can Rocket stove, on the other hand, has an insulated combustion chamber that cleans up smoke before it can escape. This feature can simultaneously improve combustion efficiency and heat-transfer efficiency. Fuel use and emissions are both reduced.

As can be seen in Figure 39, emission factors in the 20 L Can Rocket stove are reduced, compared to a carefully made 3 Stone Fire. Well-engineered combustion chambers in cooking stoves create cleaner gases which can be forced to more effectively get heat into the pot. This type of stove can use less wood and make less smoke, while boiling water faster than the 3 Stone Fire.

Figure 39 - Comparison of emission factors (EF)

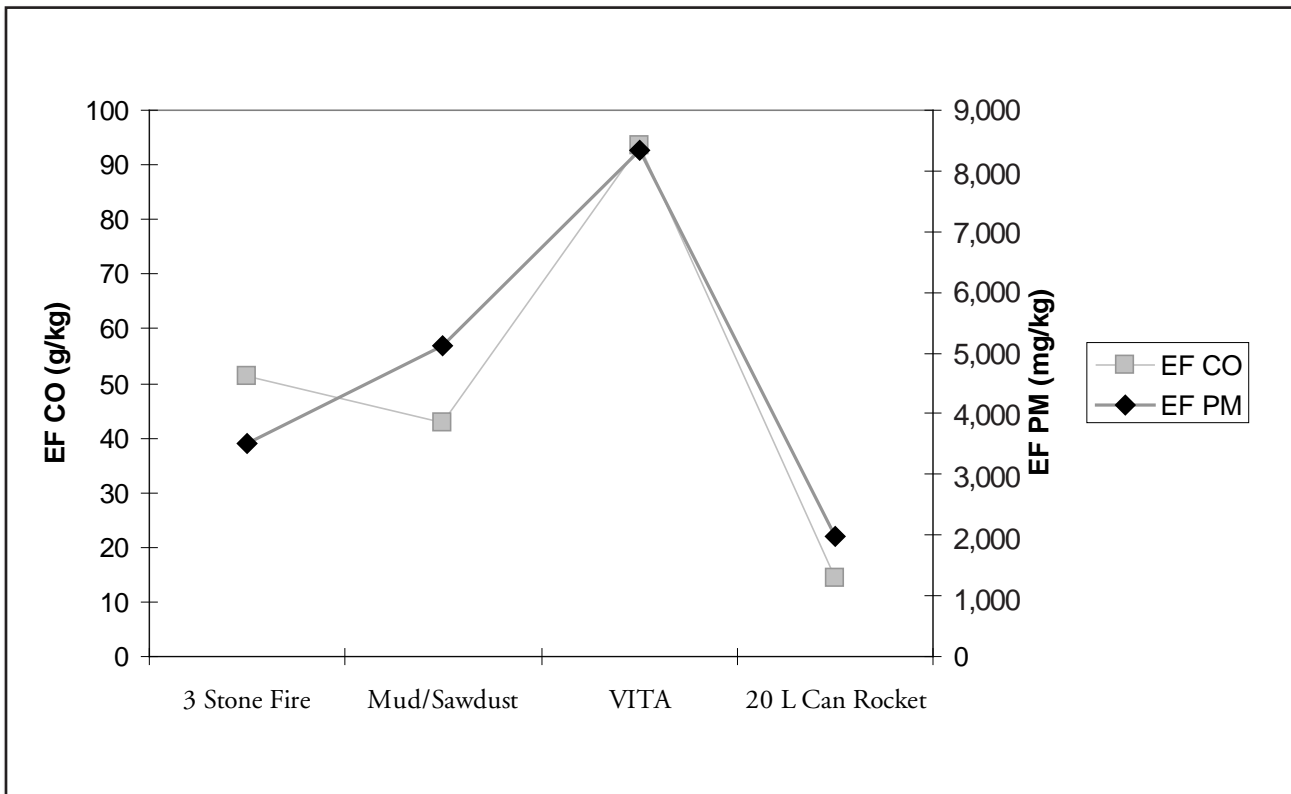

Does CO predict PM?

It might possible to use measured CO levels to predict a general expected level of PM for a given fuel. Generally, it is much easier to measure CO than PM. If a correlation can be established, stove researchers might be able to simplify measurements in the field.

Some researchers report that CO and PM are related. The levels in a house or in the streets of a city may generally follow a similar pattern. However, CO and PM do not rise and fall together as combustion occurs.

CO is created by gases that are not burnt up in the flame. Burning wood usually produces high levels of CO when the fire is started. CO levels rise as burning wood makes charcoal. Alternately, PM is seen when the fire makes flame. Both CO and PM tend to rise when fresh wood is added. Each pollutant is produced by a different mechanism, at various times during a cooking task. Figure 40 shows a typical record of CO and PM emissions during a Water Boiling Test.

In the tests done at Aprovecho, charcoal- and liquid-fuel stoves did not emit levels of CO and PM like wood-burning stoves. Burning charcoal makes high levels of CO, but relatively low levels of PM. Liquid gas fuels produce almost no PM when the stove is properly tuned.

As can be seen in Figure 41, in the test kitchen the levels of CO and PM when water is brought to a boil and simmered for 30 minutes do seem to be related. Most stoves that emitted less CO also produced less PM.

Figure 42 details the same comparison for stoves tested under the emissions collection hood. It should be noted that due to problems with the data, only one Water Boiling Test for PM could be used. The PM hood results show the average of cold and hot starts to boil that are added to the emissions for simmering for 45 minutes. The levels of CO are the average of three Water Boiling Tests. This analysis also shows a positive relation, although the Ghana Wood and Ecostove PM levels seem unexpectedly high.

Figure 40 - Comparison of emission factors (EF) for improved heat transfer

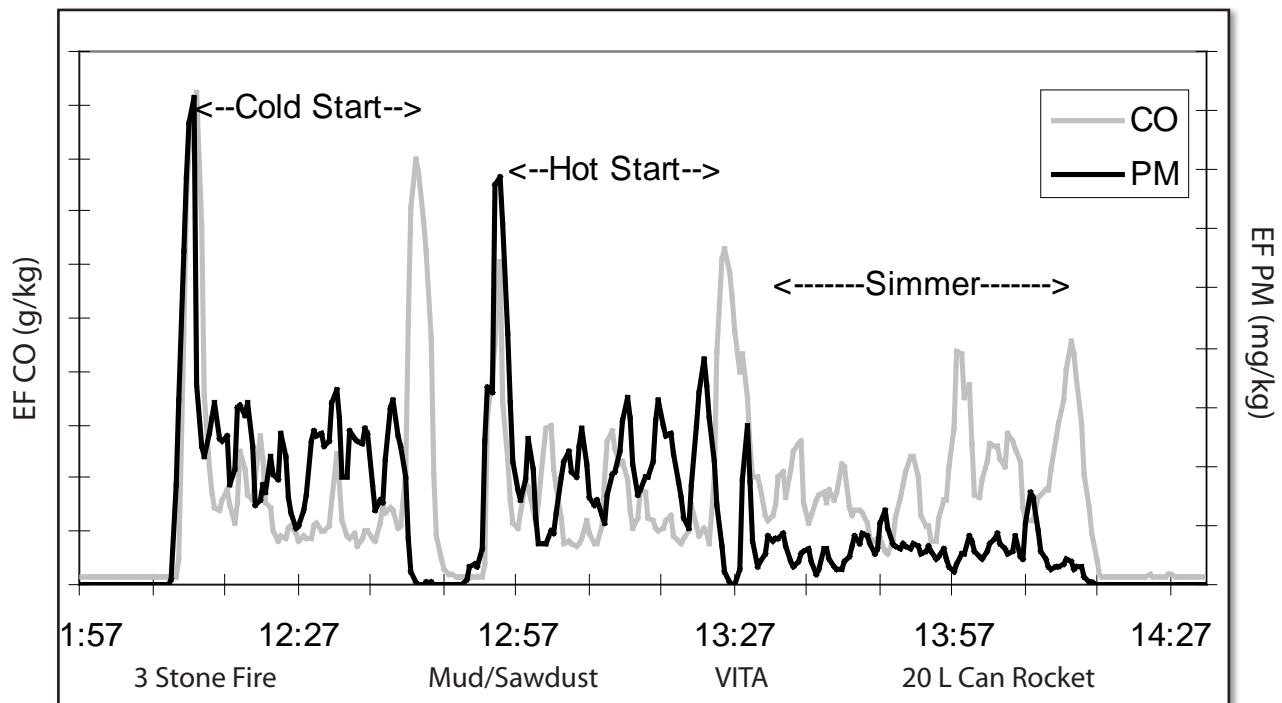

In this study, the levels of CO and PM do seem to be related for stoves burning the same type of fuel. Clean-burning stoves remove most of the PM and CO, and polluting stoves emit high levels of PM and CO. Stoves with chimneys remove both PM and CO from the kitchen. However, some stoves reduce CO while increasing PM. Of course, charcoal stoves emit much more CO than PM.

It may not be safe to assume that clean-burning stoves reduce both PM and CO in proportional amounts, because this assumption does not hold true for all stoves. Further studies would be required for a particular application.

Figure 41 - Relation of CO and PM for a cooking task in the test kitchen

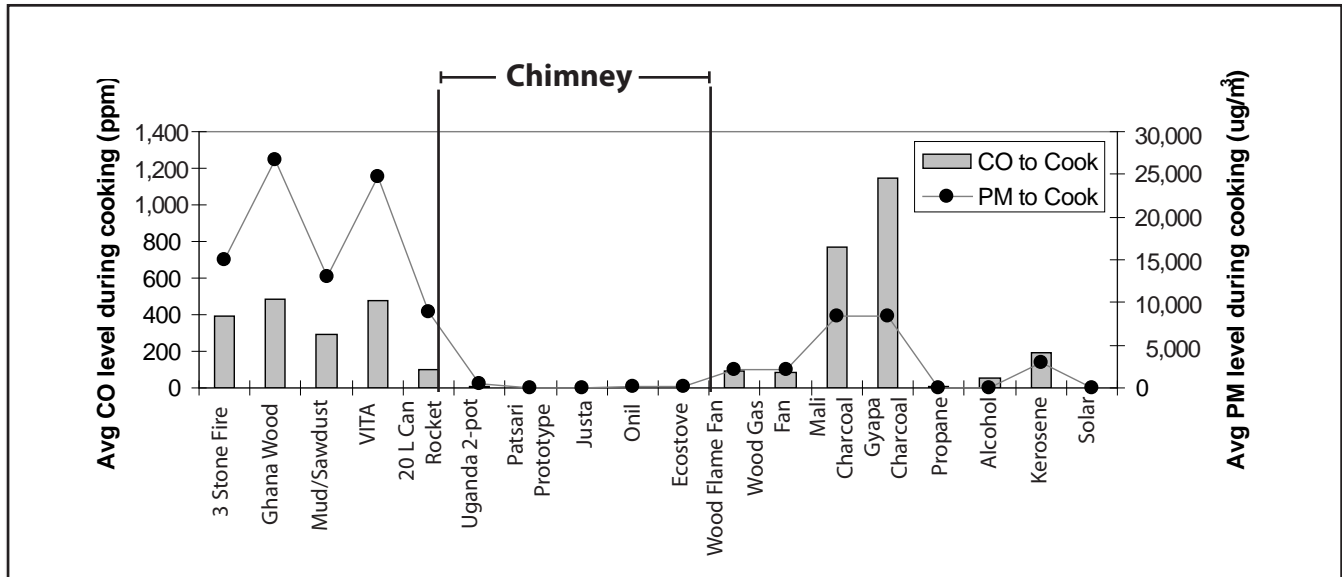
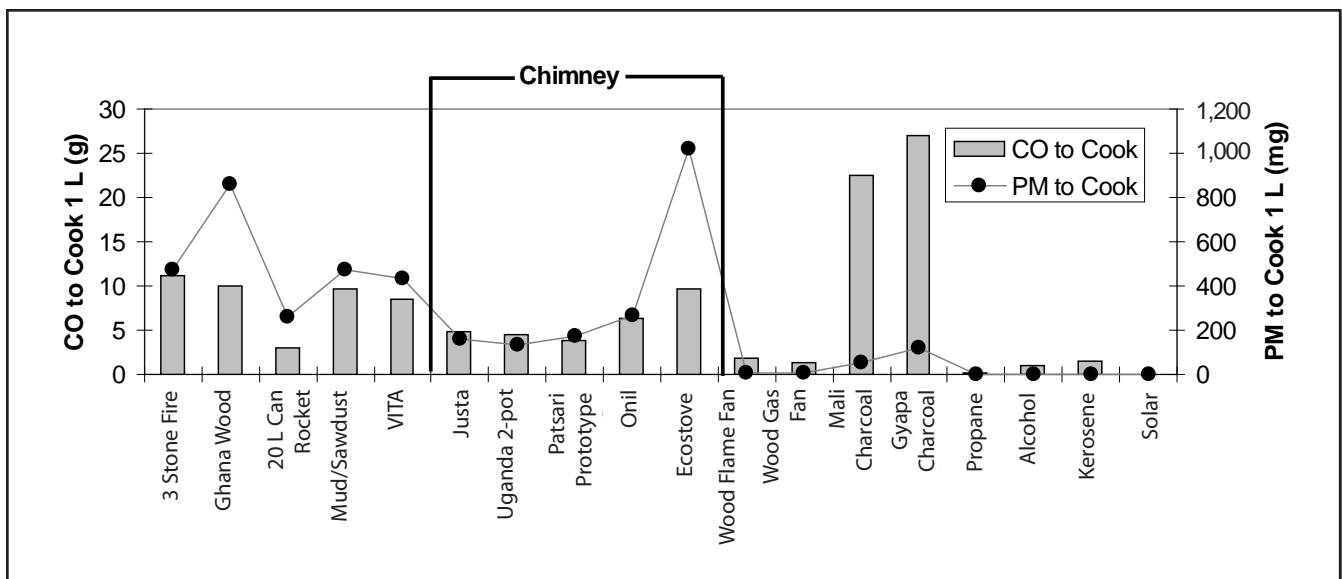

Figure 42 - Relation of CO and PM for a cooking task under the emissions collection hood



How do hydrocarbon emissions compare?

Hydrocarbons are unburned gases with hydrogen-carbon bonds such as propane, methane, butane and hexane. Like other pollutants, hydrocarbons are harmful to human health and contribute to global warming. The Enerac 3000E (Figure 43), used in the Aprovecho emissions hood, uses non-dispersive infrared (NDIR) to count the number of carbon bonds to determine the concentration of hydrocarbons, reporting them as propane. Since the Enerac is designed for higher concentrations of hydrocarbons and counts all as propane, the results presented in Figure 44 may not be accurate in magnitude. However, it is possible to compare the relative amounts of hydrocarbons emitted by stoves.

As measured by the Enerac 3000E, the two charcoal stoves emitted about twice as much unburnt hydrocarbons as the wood-burning stoves. As with CO and PM emissions, the wood-

burning stoves that produced the least amount of hydrocarbons used either rocket combustion chambers or fans. Because there is significant difference in measured hydrocarbon emissions, further study seems warranted.



Figure 43 - Enerac 3000E

Figure 44 - Hydrocarbon emissions to cook 1 L

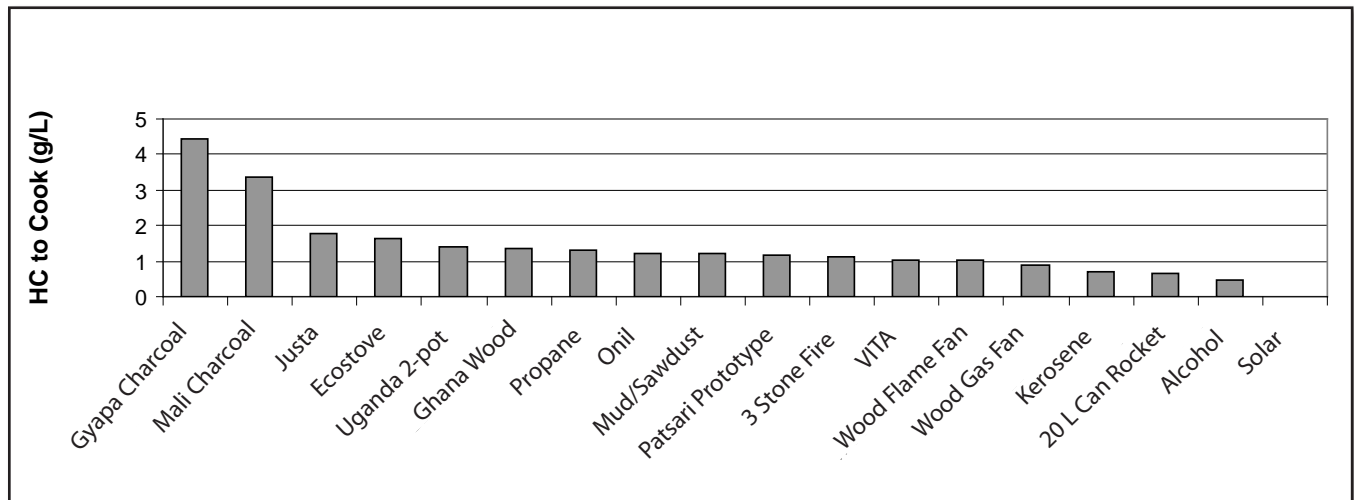

How does emission testing with a hood or in a test kitchen compare?

Two different methods were used in this study to measure the emissions from different stoves when performing a standard task: boiling and simmering water in the same pot.

The exhaust collection hood (Figure 45) creates a constant flow of air which is carefully measured so that the amount of pollutants is known. The amount of air leaving the test kitchen (Figure 46) also has to be controlled. Tests cannot be done on windy days and all windows and doors must be closed as the stove burns fuel. The intent of both methods is to reduce the factors that affect stove performance measurements.



Figure 45 - Testing hood

The hood collects all the smoke and draws it past measuring devices; monitoring equipment in the test kitchen is immersed in the smoky air. One of the big differences between testing with a hood or in a kitchen is the cost. The equipment used in the hood (Enerac 3000E, Radiance M903 Nephelometer, etc.) cost more than \$20,000. The instruments for the hood were chosen to provide real-time information about emissions so that designers could understand stoves better. It also provides specific emissions in pollutant per cooking task or per kilogram of fuel burned. The portable equipment used in the test kitchen (AP Buck filter system, HOBO CO

monitor) cost less than \$2,000. However, it cannot provide such detailed information.

It took more than a year to build the hood and calibrate it so that the results were usable. The portable equipment used in the test kitchen is made to be used by field personnel with little training. One reason for the long development time for the hood was that few stove developers had used this kind of system before. New procedures and instruments had to be developed. On the other hand, many researchers had already been using in-field indoor air pollution (IAP) monitors which were placed in the test kitchen to assess air quality.

How did the data from the hood and the test kitchen compare?

Three Water Boiling Tests (WBTs) were performed under the hood and three shortened WBTs were performed in the test kitchen. The average results for each stove are shown in Figures 47 and 48. The stoves equipped with chimneys removed almost all pollutants from the test kitchen. The emissions of the stoves with chimneys were measured under the hood from the chimney exit. For this reason, the results from the hood and in the test kitchen

It should be noted that testing stoves in a test kitchen exposes the tester to high levels of smoke and carbon monoxide. In these tests, the stove operator always wore a respirator that directly provided fresh air for breathing.



Figure 46 - Test kitchen

for stoves with chimneys cannot be compared. The kitchen test shows the levels of pollutants in the room. The hood tests show total emissions that affect the environment.

In most cases, for stoves without chimneys, the levels of CO measured under the hood and in the test kitchen were quite similar.

Figure 48 compares the PM data from the hood and test kitchen. Unfortunately, the PM data from two of the three tests done under the hood could not be used because of technical problems. However, there is general agreement (for stoves without chimneys) between the results for PM from the test kitchen and the hood. Again, the

chimney stoves on the right side of the graphs were measured differently and cannot be compared.

When stove prototypes are being developed, emission data are important. Measuring how cleanly stoves operate is necessary for the evaluation of stoves that are to be distributed.

Using an emission hood or a standardized test kitchen are two ways to provide data on pollution made by stoves. The test kitchen has the advantage of lower cost and easier to use equipment. The hood is more accurate and provides more reliable information that answers a wider variety of questions. Either, when used carefully and systematically, can be used to compare cook stoves.

Figure 47 - CO to cook 5 L under emissions hood and average CO Level in test kitchen

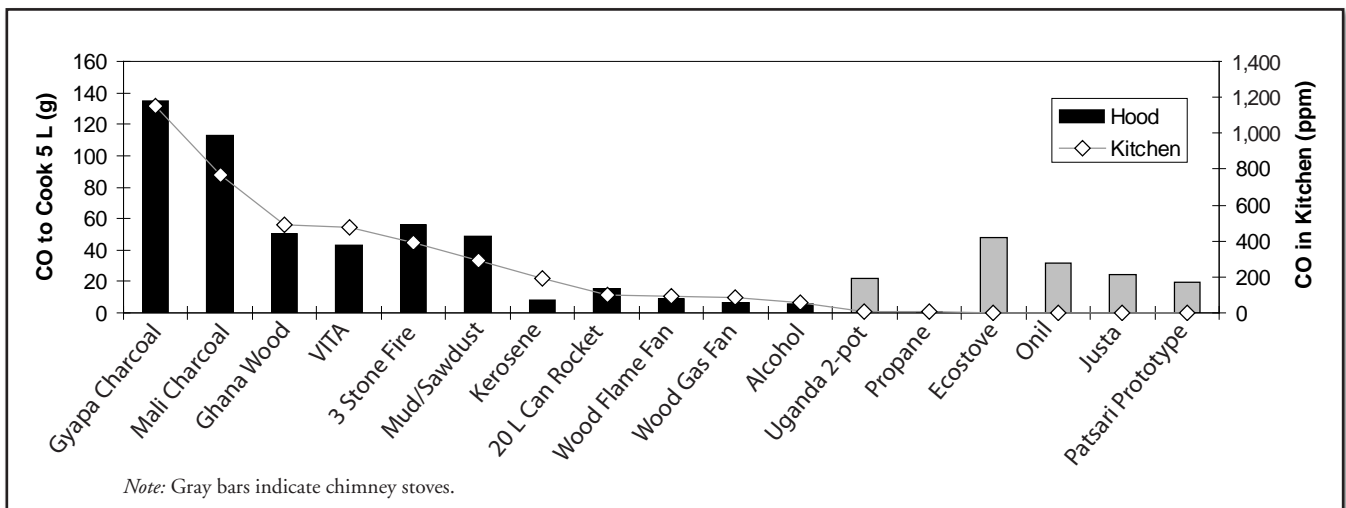
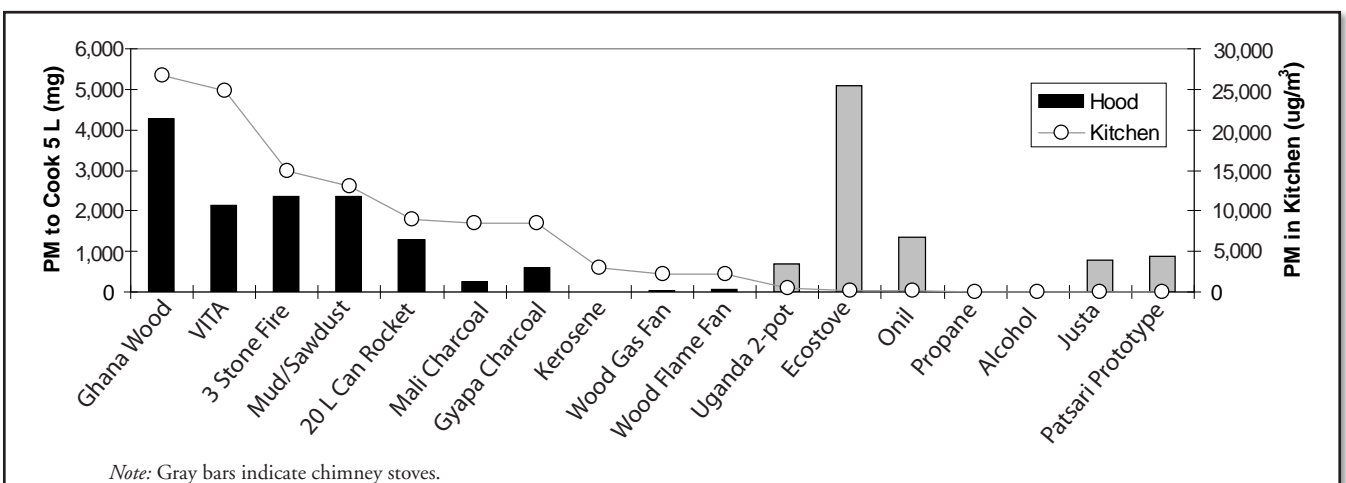

Figure 48 - PM to cook 5 L under emissions hood and average PM Level in test kitchen



What is an “improved” cook stove?

The eighteen stoves in this study were tested under an emission hood and in a test kitchen, using various monitoring devices. Capturing the emissions in the hood makes it possible to estimate the mass of CO and PM made during a cooking task. In the test kitchen, the parts per million (ppm) of CO and the micrograms per cubic meter ($\mu\text{g}/\text{m}^3$) of PM in the room air are monitored, using portable equipment. Assuming that the air exchanges in the test kitchen are relatively constant, higher readings of pollution in the air are caused by stoves that are burning less cleanly.

The CO/CO₂ ratio has been suggested as another method for determining how cleanly a stove is

burning. It is calculated by dividing the amount of CO by the amount of CO₂. A lower ratio means that more CO₂ and less CO were produced during the Water Boiling Test. If biomass fuel is burned cleanly, more CO₂ is made and less CO is emitted. The CO is combusted and changed into CO₂. A stove that is operating at 100% combustion efficiency would emit only CO₂ and water.

It may be possible to use the CO/CO₂ ratio as a benchmark for stove combustion efficiency. The South African Bureau of Standards suggests that the CO/CO₂ ratio from paraffin (kerosene) stoves should be 2% or less. Both CO and CO₂ are relatively simple to measure with equipment that has a combined cost of about \$600.

The following graph (Figure 49) shows the average results of three Water Boiling Tests of each stove

Figure 49 - Comparison of CO/CO₂ ratio and CO produced per liter to cook

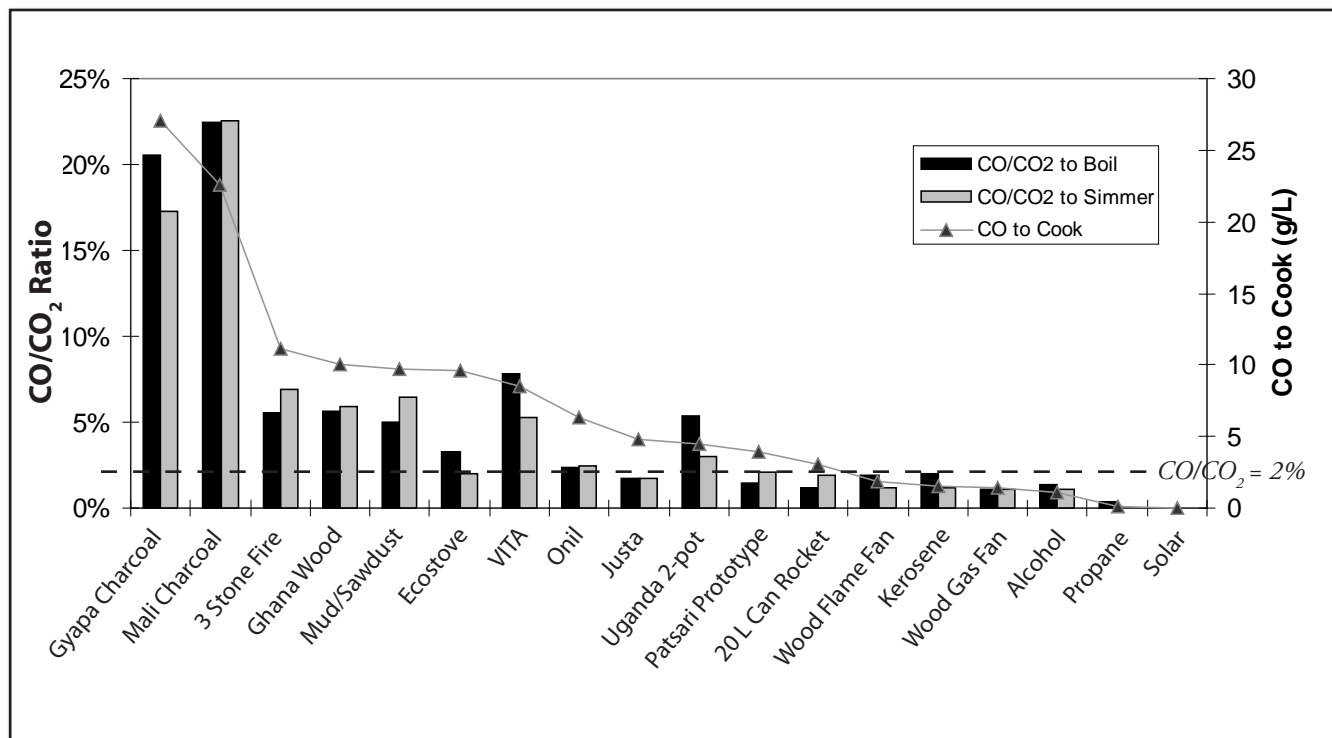

conducted under the emissions hood. The propane, kerosene, fan stoves and the rocket stoves meet the suggested benchmark of 2% of CO/CO₂. The CO/CO₂ ratio also seems to be correlated to another measure of CO generated from the Aprovecho emissions hood: the amount of CO produced to boil and simmer 1 L of water. The emissions hood results are presented as the mass of CO produced per liter of water boiled and then simmered during the Water Boiling Test.

Benchmarks for emissions can also be created using the data from the hood or test kitchen. Fuel use is also comparable. Figure 50 shows two lines drawn across the graph that could establish a proposed level of acceptable performance.

The Shell Foundation asked Aprovecho Research Center to use the data from these tests to create proposed benchmarks to encourage the production of improved cooking stoves (ICS) that save fuel and reduce indoor air pollution. The lines that cross Figures 50, 51 and 52 are for stoves with and without chimneys. Both fuel used and energy used to cook 5 L are included.

A suggested benchmark for fuel and energy use is (Figure 50):

1. Fuel use: Using the International Testing Pot, a cooking stove without a chimney should use less than 850 grams of wood or less than 15,000 kJ of energy to bring to boil 5 L of 25° C water and then simmer it for 45 minutes during the University of California, Berkeley revised Water Boiling Test. Stoves equipped with chimneys should accomplish the same task, consuming less than 1,500 grams of wood or 25,000 kJ of energy.

A suggested benchmark for CO produced is (Figure 51):

2. Emissions: A cooking stove without a chimney should produce less than 20 grams of carbon monoxide to boil 5 L of 25° C water and then simmer it for 45 minutes during the University of California, Berkeley revised Water Boiling Test. Wood-burning stoves equipped with chimneys are exempt from the above standard if the stove does not allow more than 50 ppm of CO to pollute the air within 30 cm of the stove in the standard test kitchen with a controlled air exchange.

Figure 50 - Fuel and energy to cook 5 L vs. benchmark

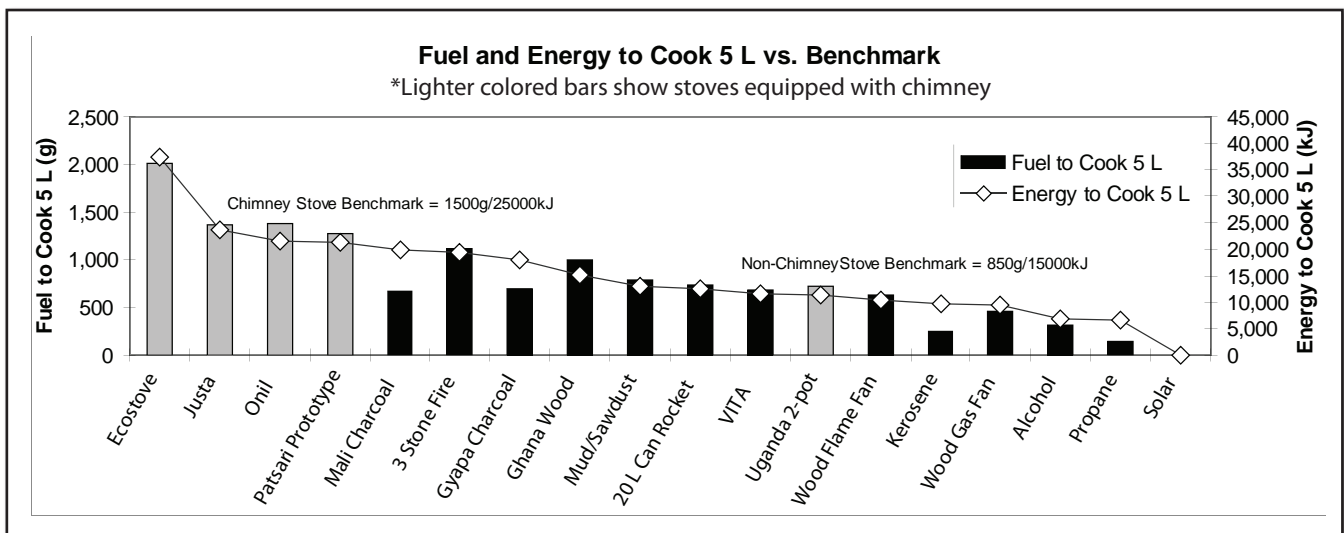

A suggested benchmark for PM is (Figure 52):

3. Emissions: A wood-burning stove without a chimney should produce less than 1,500 milligrams of PM (with a total size of 2.5 micrometers in aerodynamic diameter or smaller) to boil 5 L of 25° C water and then simmer it for 45 minutes during the University of California, Berkeley revised Water Boiling Test.

These preliminary suggestions show how performance benchmarks can be created from data generated from various methods. Benchmarks can

be developed using the CO/CO₂ ratio or from test kitchen or emission hood results. Each method has advantages and disadvantages. CO/CO₂ and test kitchen results are obtained using less expensive but less accurate equipment. The emission hood data are probably the most accurate, but a hood system is complicated and more expensive. Before a set of performance benchmarks is generally adopted, more research and development are needed. The suggested fuel use and emission levels can be adjusted up or down. Benchmark levels can be determined using various emission monitoring systems.

Figure 51 - CO to cook 5 L and average CO level in test kitchen vs. benchmark

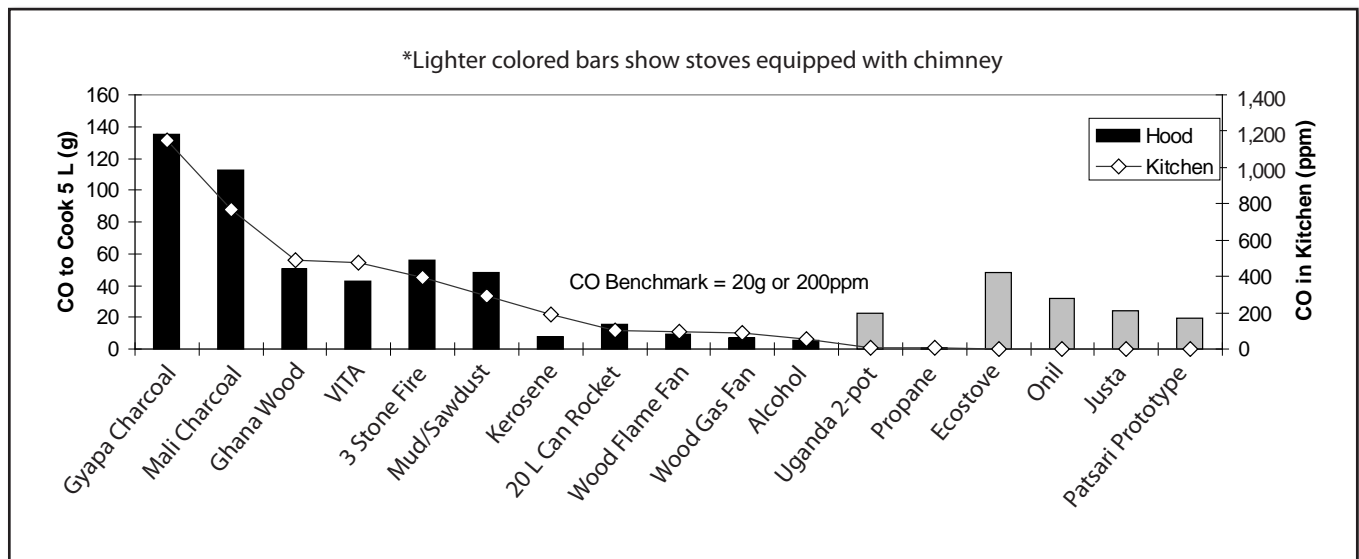
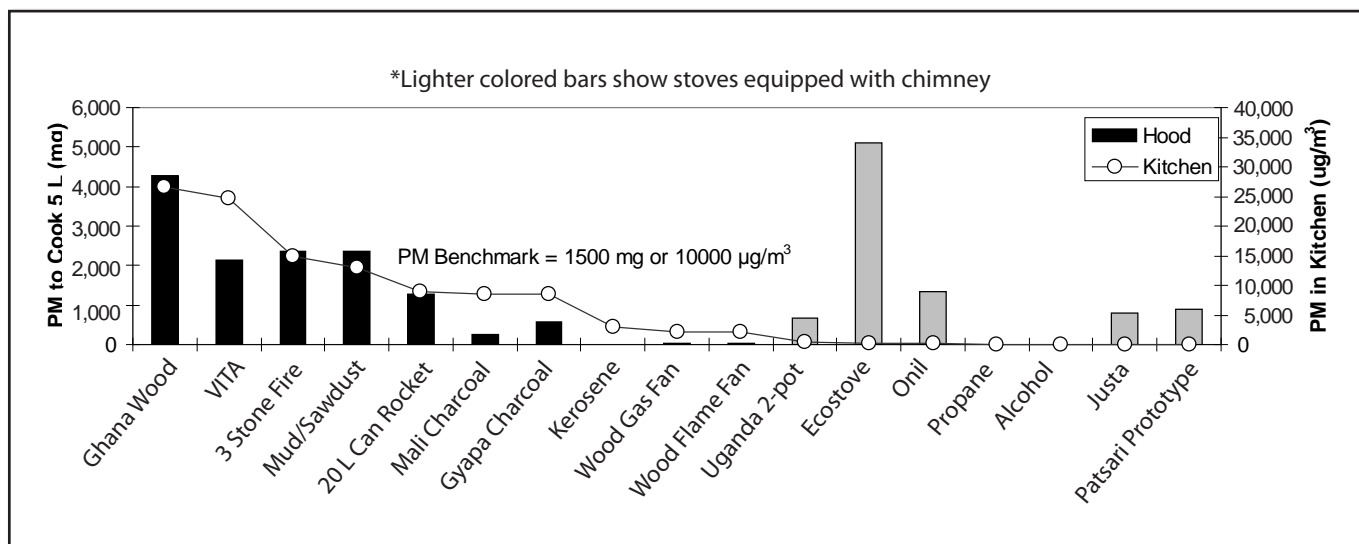

Figure 52 - PM to cook 5 L and average PM level in test kitchen vs. benchmark



How can wood-burning cook stoves be improved?

The success of some of the groups of stoves in this study point out a few simple techniques that help to improve performance.



Functional chimneys can address the problem of indoor air pollution.

Chimneys are the practical solution that evolved in all developed or industrialized countries to remove harmful pollution from the indoor environment. The Onil stove, the Ecostove, and the Uganda 2-pot stove (Figure 53) have chimneys that removed most emissions from the test kitchen.

The test kitchen is a 15 m³ building in which a door and a window are closed to simulate the worst conditions when fire is used inside in a cold climate. Even in this mostly unventilated structure, stoves with chimneys removed most of the pollution. It is important to use a cooking stove with good draft, however. If smoke can flow out of the fuel entrance, or leak in other ways into the room, harmful emission levels will rise.

Chimney stoves dramatically reduced the emissions of PM and CO, as can be seen in Figure 54. The use of chimneys is probably the most cost-effective technique to address the problem of indoor air pollution.

Figure 53 - Chimney Stoves

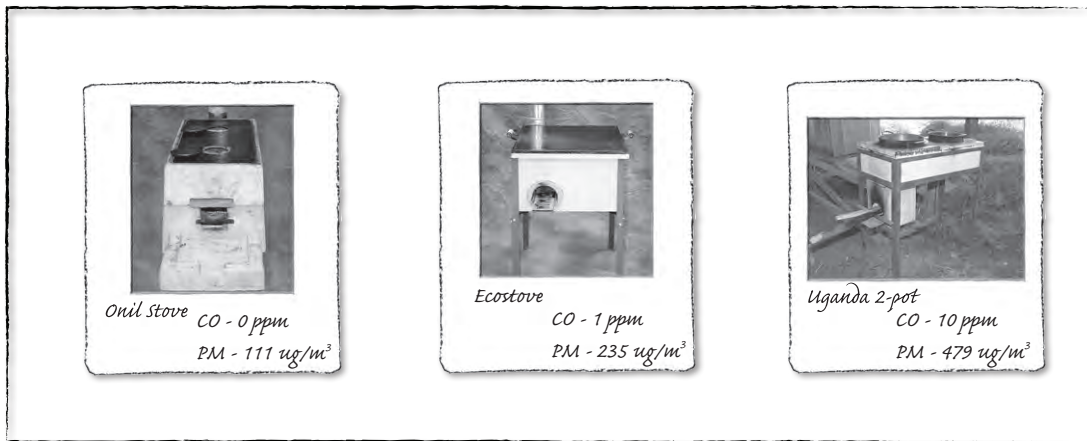
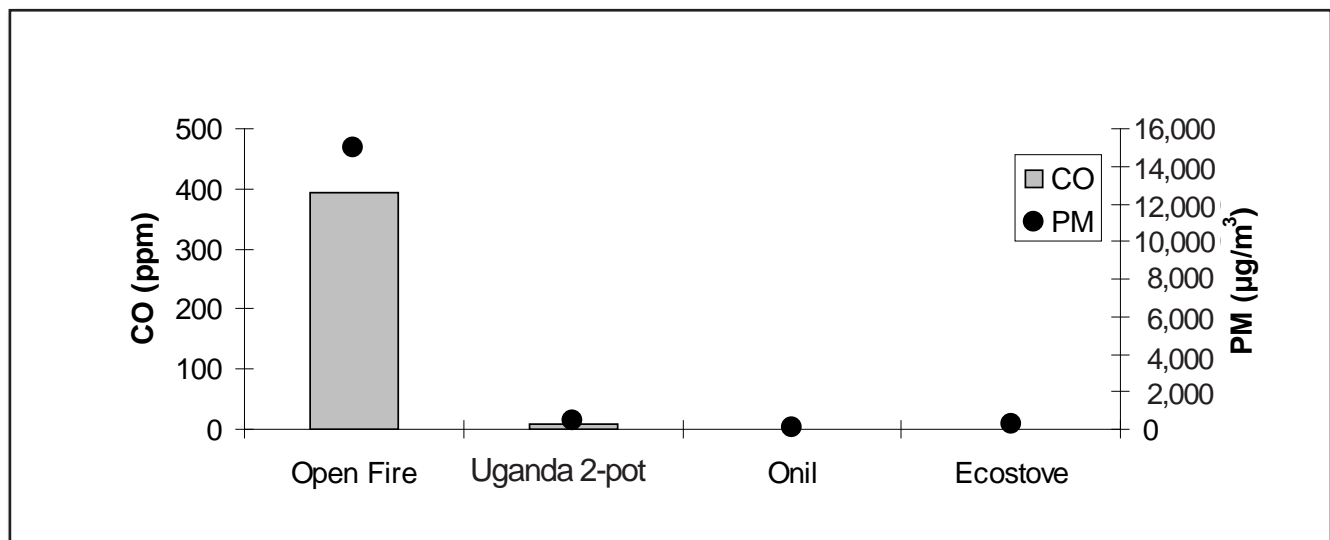

Figure 54 - Concentration of CO and PM in the test kitchen generated by stoves with chimneys





Providing an insulated combustion chamber around and above the fire creates better mixing of gases, flame and air, which helps to boil water faster, reduces fuel use, and decreases CO and PM. The 20 L Can Rocket, the Uganda 2-pot, Justa, and the Patsari Prototype stoves have “rocket type” insulated combustion chambers (meaning L-shaped insulated combustion chambers)(Figure 55). The higher temperatures and improved mixing in an insulated enclosed space above the fire reduces harmful emissions (Figure 56).

Figure 55 - Five stoves with rocket-type combustion chambers

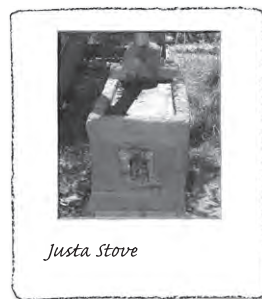
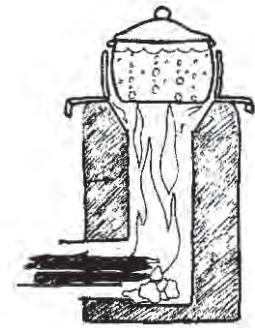
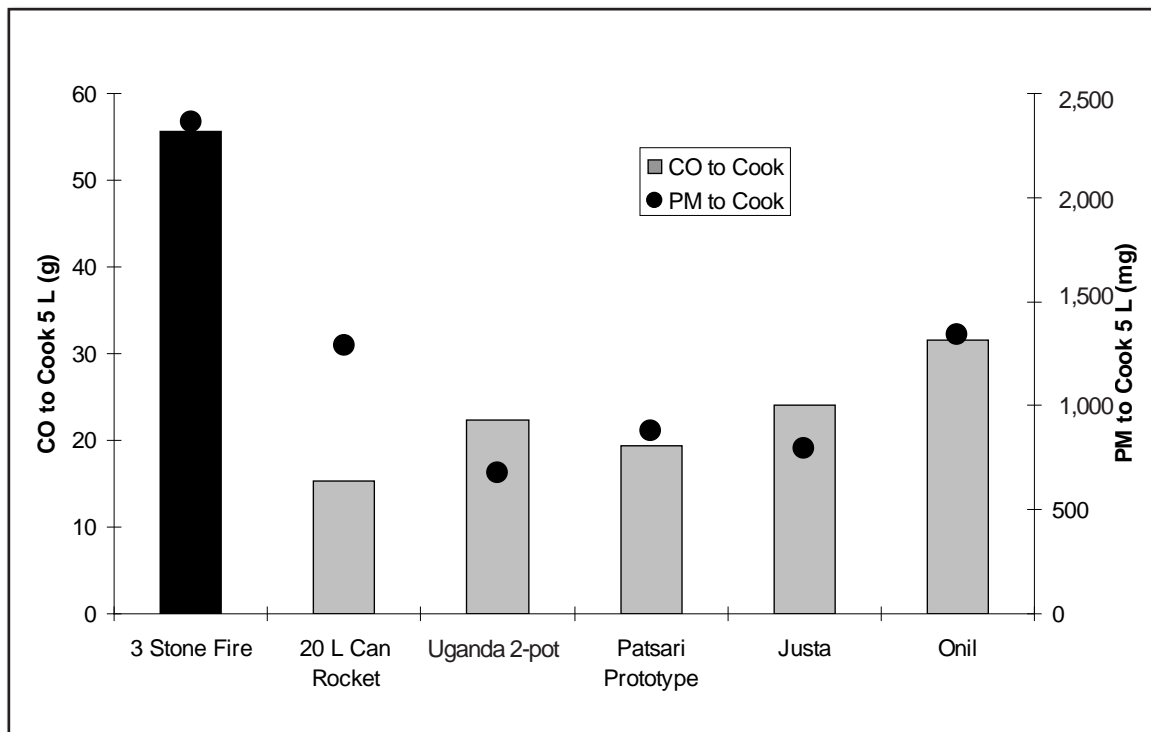

Figure 56- Insulated combustion chamber CO and PM emissions to cook 5 L





Forcing the hot gases to flow against as much of the pot or griddle as possible improves heat transfer.

This is an effective method to reduce the fuel needed for cooking. The 20 L Can Stove, the VITA stove, the Uganda 2-pot stove and the Mud/Sawdust stove use small channels that direct the hot gases to contact the sides and bottom of the cooking pot. Baldwin and Winiarski have shown that improving heat transfer significantly decreases fuel use.

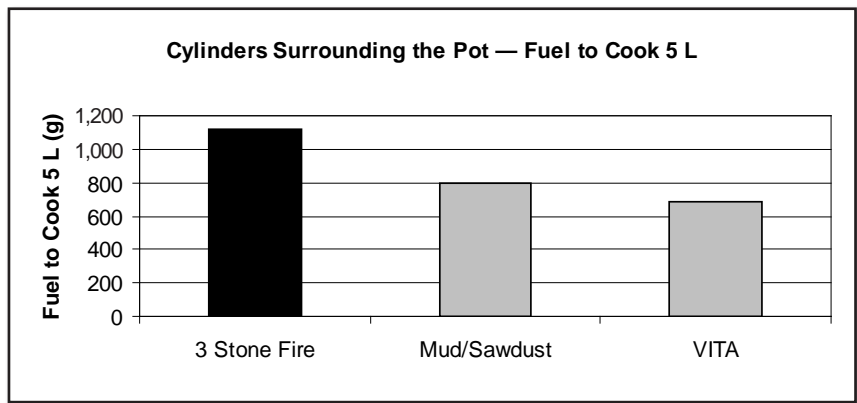

Figure 57

The VITA (Figure 59) and Mud/Sawdust (Figure 58) stoves are cylinders surrounding the pot, creating a small gap between the pot and stove body. This simple technique dramatically reduces fuel use (Figure 57). In outdoor cooking situations where fuel efficiency, not reduction of emissions, is most important, this approach provides a low-cost method for decreased fuel consumption.

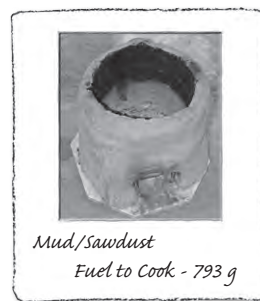

Figure 58



Figure 59



Stoves can be designed with small fans that create high-velocity, low-volume jets of air that mix fuel, air and flame. This mixing is mostly missing in stoves without fans. Mixing dramatically reduces pollution (Figure 61). The Wood Flame and Wood Gas stoves burn wood much more cleanly. Adding low-cost fans to stoves could provide another low-cost solution to cleaner, more efficient cooking with biomass (Figure 60 & 61).

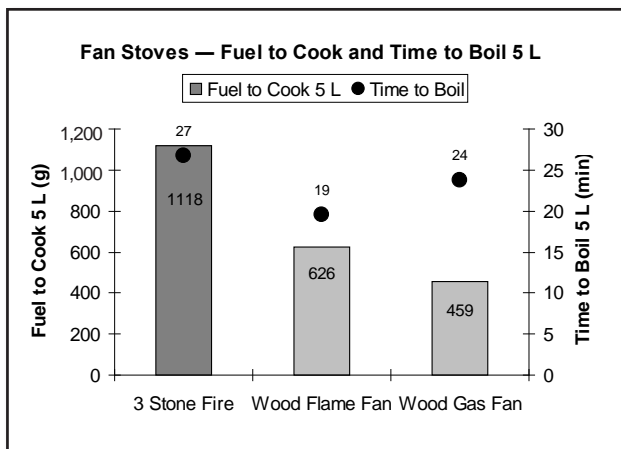

Figure 60

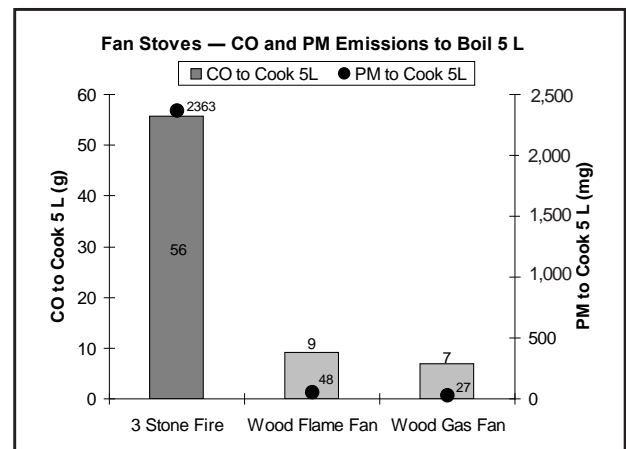

Figure 61

Appendix A

Glossary

Benchmarks: Suggested measures of performance that, in this case, seek to define an improved cook stove.

Boundary layer: The very thin layer of slowly moving air immediately adjacent to a pot surface that insulates the pot from the hot flue gases and decreases the amount of heat that enters the pot.

Carbon monoxide: An odorless, colorless gas that is harmful to health produced by the incomplete combustion of fuel.

Convection: The heat transfer in a gas or liquid by movement of the air or water.

Combustion chamber: The area of a stove where the fuel is burned.

Combustion efficiency: The percentage of energy in fuel that is turned into heat.

Constant Cross Sectional Area: Maintaining spaces with the same volume measured at right angles to the flow throughout a stove.

Draft: The movement of air through a stove and up the chimney.

Emissions: Byproducts from the combustion of fuel that are discharged into the air.

Emissions Hood: An instrument that captures and measures the mass of emissions from burning fuels.

Excess Air: Air used for combustion that exceeds the theoretical (stoichiometric) amount needed.

Firepower: A measure of how much energy is released from burning fuel per unit of time.

Flue Gas: The hot gas from burning fuel that flows up from the combustion chamber.

Grate: A framework used to hold the fuel above the combustion chamber floor.

Heat Transfer Efficiency: The percentage of available energy released from the fuel that entered the pot.

High Mass Stove: A stove made from dense materials such as earth, clay and sand that absorb heat from a fire more readily than lighter, more insulative materials.

Hydrocarbons: A mixture of gases including propane, methane and butane released from wood fuel but that remain unburnt and exit the stove due to incomplete combustion.

Mixing: The combining of air, hot gases and flame to reduce emissions. Biomass stoves do not mix air, hot gases and flame very well, so smoke and unburnt gases are often not fully combusted.

$\mu\text{g}/\text{m}^3$: Micrograms per cubic meter, the measure of concentration of particulate matter in air.

Overall Efficiency: The combination of heat transfer efficiency and combustion efficiency expressed as a percentage.

Particulate Matter: The fine particles that make up smoke. They can vary in size and composition and are harmful to health when breathed. The smaller the particle, the more deeply into the body it can travel.

Pot Skirt: A cylinder, usually made from sheet metal, that creates a narrow channel around the sides of a pot to increase heat transfer efficiency.

ppm: Parts per million, a measure of the concentration of a gas in air.

Retained Heat Cooker: A relatively air-tight, well-insulated box that uses captured heat to simmer a hot pot of food to completion.

Specific Consumption: The fuel used per unit of product produced, e.g., how much wood was used to cook a liter of beans.

Stratification: The levels of smoke and other pollutants that rise and can be more highly concentrated near the ceiling of a room.

Test Kitchen: A kitchen used for testing emissions in which the air exchanges are controlled to reduce the effect of ventilation on the measured levels of emissions.

Turn Down Ratio: The ratio between high and low power in a stove. The high firepower is divided by the low firepower.

Ventilation: The exchange of air from the outside to the inside of a building.

Water Boiling Test (WBT): A standardized test in which water is boiled and simmered. Fuel use and other parameters, including emissions, are measured. The WBT is designed to investigate the heat transfer and combustion characteristics of a stove under controlled operating procedures.

Appendix B

Testing Methods

How were the tests performed and analyzed?

Many variables affect the performance of a cook stove. Whether the stove was cold or hot when started, the difference in performance when slowly simmering and rapidly boiling, and the skill of the operator all affect the test results.

A standard method for determining stove performance is the UCB 2003 Revised Water Boiling Test. This test has three phases:

1. Bringing 5 L of water to a boil at high power with the stove starting cold, or “cold start.”
2. Bringing 5 L of water to a boil at high power with the stove starting hot, or “hot start.”
3. Simmering 5 L of water for 45 minutes at low power (3° to 6° C below full-boiling temperature).

The international standard 7 L stainless steel testing pot with no lid was used for each test for each stove except the alcohol stove.

Kiln-dried Douglas fir cut into sticks 1 cm x 1.5 cm x 30 cm was used for fuel. The fan stoves were fueled by 5 cm x 3 cm x 1.5 cm pieces of the same wood. The fuel was carefully metered into the fire in an effort to operate each stove as effectively as possible.

The levels of emissions released during a Water Boiling Test (WBT) varied depending on how and where they are measured. Two approaches involve 1) collecting all the smoke under a hood and 2) monitoring the amount of smoke dispersed in the air of a test kitchen.

Emission testing provides information about how cleanly the stove changes fuel into useable heat. Emission testing can also shed light on how much carbon monoxide (CO), particulate matter (PM) and other pollutants are found in room air.

Three series of tests were performed on each stove:

1. WBT Series (three full WBTs per stove) – monitoring only fuel use, not emissions:
 - a. 5 L of water brought to a boil with stove at cold start.
 - b. 5 L of water brought to a boil with stove at hot start.
 - c. 5 L of water boiled again and then simmered for 45 minutes.
2. Test Kitchen Series (three per stove) – monitoring fuel use and emission concentration within an approximately 15 m³ kitchen:
 - a. 5 L of water brought to a boil with stove at cold start.
 - b. 5 L of water simmered for 30 minutes.
3. Emissions Hood Test Series (three full WBTs per stove) monitoring fuel use and collecting/recording total emissions released from each stove:
 - a. 5 L of water brought to a boil from a cold start.
 - b. 5 L of water brought to boil from a hot start.
 - c. 5 L of water simmered for 45 minutes.

(Due to technical problems, the PM data were not usable from two of the three WBTs performed under the emissions hood.)

Emissions testing hood

The emissions testing hood at Aprovecho collects all of the smoke created by a fire and records the amount of pollutants created each second.

The emissions collection hood includes the following:

Hood. A 1 m² bell with fire-resistant adjustable welder's fabric hanging from three sides. The hood may be raised or lowered depending on the size of the stove.

Exhaust System and Flow Measurements. The smoke is drawn up through the hood by using a large fan. The flow is adjusted so that the smoke is collected without inducing extra draft in the stove. Flow is measured with a manometer by pressure drop across a 1.5" diameter orifice and a type K thermocouple.

Gas Concentration Measurement. Concentrations of CO, CO₂ and hydrocarbons are measured after the orifice by an Enerac 3000E NDIR (infrared) stack meter.

Particulate Measurement. A sample of smoke is drawn from the exhaust, diluted and cooled with clean, dry air then metered using a Radiance Research Nephelometer with light-scattering analysis. The CO and CO₂ are then measured again, using sensors provided by Tami Bond and Chris Roden of UIUC, to determine the level of dilution of the smoke sample.

Data Acquisition and Analysis. Analog signals from the sensors are read by a data acquisition board connected to a computer. Concentration data are displayed in real time on a computer monitor. Data are analyzed in conjunction with WBT data entered, using an Excel spreadsheet with a Visual Basic macro developed by Tami Bond and Nordica MacCarty. The concentration of each of the emission components times the mass flow through the hood can be integrated over time to calculate how much of each pollutant was produced during a given time period. When a standard WBT (representing a cooking task) is done under the hood, it is possible to determine how much wood is consumed and how much pollution is generated in performing the task.

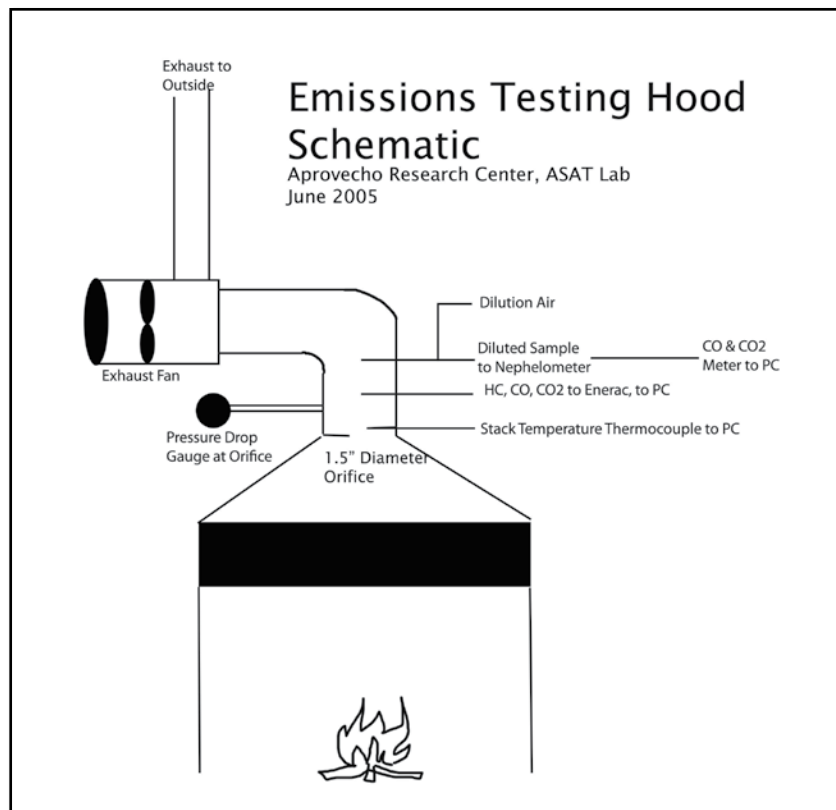

Test kitchen

The Aprovecho test kitchen is a building measuring 8 x 10 x 8 ft designed to replicate common kitchens around the world. It has been calculated to have about three air exchanges per hour. The stove tester sitting inside the kitchen wears a forced-air respirator so that he or she can breathe fresh air from outside.



Emissions monitors consist of the following:

AP Buck Personal Air Sampler measuring PM.

A common method for measuring PM is a pump and filter system that draws in air at a constant rate through a pre-weighed filter. The particles collect on the filter during the test. The filter is post weighed after the test on a very sensitive scale. The mass of the particles, factored by the rate of air flow through the filter and the amount of run time, gives the average concentration of PM entering the intake during the test. The flow rate of the pump is calibrated using an AP Buck bubble calibrator.

HOBO CO Loggers measuring CO. A common method for measuring concentrations of CO is the HOBO data logger. The HOBO uses an electrochemical cell, which puts off an electrical signal proportional to the concentration of CO in the air. The signal is recorded by an on-board data logger. The unit is launched and provides results on a personal computer, providing a moment-by-moment graph of the CO levels in the room.

Three HOBOs were used in the test kitchen: one logger 1.3 meters away from the stove, one at 1 meter off the floor and one 2.5 meters above the stove. CO tends to stratify, collecting near the ceiling. In this report, only the average readout of the HOBO 1.3 meters from the stove is reported.

In the test kitchen tests, 5 L of water were brought to a boil and then simmered for 30 minutes.

This report presents stove performance based on 10 measures of key importance. The final results were calculated as an average of the 18 total applicable test phases completed for each stove.

1. Time to Boil 5 L of water - Corrected to reflect a beginning temperature of 25° C. Average of the following (11) tests:
 - a. One cold and three hot starts in the WBT.
 - b. Three cold starts in the test kitchen.
 - c. One cold and three hot starts in the emissions hood tests.
2. Fuel to Boil 1 L - Temperature-corrected specific consumption is a measure of fuel used per liter of boiling water produced, starting from a corrected temperature of 25° C. Average of the following (11) tests:
 - a. One cold and three hot starts in the WBT.
 - b. Three cold starts in the test kitchen.
 - c. One cold and three hot starts in the emissions hood test.
3. Fuel to Simmer 1 L - Temperature-corrected specific consumption to produce 1 L of simmering water for 45 minutes, average from the following tests:
 - a. Three WBT.
 - b. Three emissions tests.
4. Fuel/Energy to Cook 5 L – found by adding the average fuel to boil 1 L to the average fuel to simmer 1 L for 45 minutes, a typical cooking

situation. This is multiplied by 5 L. When multiplied by the effective calorific value of the fuel used, a comparison of energy used is possible to compare stoves burning different fuels.

5. CO Emissions to Cook 5 L – Separate reporting from both methods of measuring.

Emissions:

- a. Emissions Hood – Monitoring the quantity of CO produced each second to find the grams of CO produced during each test phase. To find CO emissions to cook 5 L, the average grams of CO produced to boil 1 L in cold and hot starts is added to the CO produced to simmer 1 L for 45 minutes, averaged across three tests under the emissions hood.

- b. Test Kitchen – The average of three tests reporting the average of the CO concentration recorded by a HOBO CO sensor at breathing level in the test kitchen for the duration of a cooking situation (boil 5 L and then simmer for 30 minutes).

6. Particulate Emissions to Cook 5 L – Separate reporting from both methods of measuring emissions:

- a. Emissions Hood – Data from one WBT data monitoring the micrograms of PM emissions each second to find the specific milligrams of PM produced during each test phase. The average milligrams of PM produced to boil 1 L in cold and hot starts is added to the PM produced to simmer 1 L for 45 minutes under the emissions hood.

- b. Test kitchen – Average of three tests of the average PM concentration recorded by an AP Buck Pump and Filter system at breathing level in the test kitchen during the duration of a cooking situation (boil 5 L and then simmer for 30 minutes).

7. Thermal Efficiency – Energy transferred into the water expressed as heating and vaporization divided by energy consumed from the wood. Average of all tests.
8. Firepower – Energy in the fuel consumed divided by the time of burning in seconds. Average of all tests.
9. CO/CO₂ Ratio – Grams of CO converted to moles divided by grams of CO₂ converted to moles produced during each phase of testing. Average of all emissions hood tests.
10. Emission Factors – Mass of pollutant divided by mass of dry fuel consumed during the test phase. Average of all emissions hood tests.
11. Turn Down Ratio – High-power firepower divided by Low-power firepower.

The following pages contain the full testing data and information on variation between tests.

Appendix C

Testing Data

Calculations and Theory for the UCB 2003 Revised Water Boiling Test

Variables that are directly measured

f_{hi}	Weight of fuel before test (grams)
P_{hi}	Weight of pot with water before test (grams)
T_{hi}	Water temperature before test (°C)
t_{hi}	Time at start of test (min)
f_{hf}	Weight of wood after test (grams)
c_h	Weight of charcoal and container after test (grams)
P_{hf}	Weight of pot with water after test (grams)
T_{hf}	Water temperature after test (°C)
t_{hf}	Time at end of test (min)

Variables that are calculated

f_{hm}	Wood consumed, moist (grams)	$f_{hm} = f_{hf} - f_{hi}$
$\bullet c_h$	Net change in char during test phase (grams)	$\bullet c_h = c_h - k$
f_{hd}	Equivalent dry wood consumed (grams)	$f_{hd} = f_{hm} * (1 - (1.12 * m)) - 1.5 * \Delta c_h$
w_{hv}	Water vaporized (grams)	$w_{hv} = P_{hi} - P_{hf}$
w_{hr}	Water remaining at end of test (grams)	$w_{hr} = P_{hf} - P$
$\bullet t_h$	Duration of phase (min)	$\bullet t_h = t_{hf} - t_{hi}$
h_h	Thermal efficiency	$h_h = \frac{4.186 * (P_{hi} - P) * (T_{hf} - T_{hi}) + 2260 * (W_{hv})}{f_{hd} * LHV}$
r_{hb}	Burning rate (grams/min)	$r_{hb} = \frac{f_{hd}}{t_{hi} - t_{hf}}$
SC_h	Specific fuel consumption (grams wood/grams water)	$SC_h = \frac{f_{hd}}{P_{hf} - P}$
SC_h^T	Temp-corrected specific consumption (grams wood/grams water)	$SC_h^T = \frac{f_{hd}}{P_{hf} - P} * \frac{75}{T_{hf} - T_{hi}}$
FP_h	Firepower (W)	$FP_h = \frac{f_{hd} * LHV}{60 * (t_{hi} - t_{hf})}$
TDR	Turn down ratio	$TDR = \frac{FP_h}{FP_s}$

Explanations of Calculations

f_{cm} - Wood consumed (moist): This is the mass of wood that was used to bring the water to a boil found by taking the difference of the pre-weighed bundle of wood and the wood remaining at the end of the test phase:

$$f_{cm} = f_{cf} - f_{ci}$$

$\bullet c_c$ - Net change in char during test phase: This is the mass of char created during the test found by removing the char from the stove at the end of the test phase. Because it is very hot, the char will be placed in an empty pre-weighed container of mass k (to be supplied by testers) and weighing the char with the container, then subtracting the two masses.

$$\bullet c_c = c_c - k$$

f_{cd} - Equivalent dry wood consumed: This is a calculation that adjusts the amount of wood that was burned in order to account for two factors: (1) the energy that was needed to remove the moisture in the wood and (2) the amount of char remaining unburned. The calculation is done in the following way:

$$f_{cd} = f_{cm} * (1 - (1.12 * m)) - 1.5 * \Delta c_c$$

The factor of $1 - (1.12 * m)$ adjusts the mass of wood burned by the amount of wood required to heat and evaporate $m * f_{cm}$ grams of water. It takes roughly 2,260 kJ to evaporate a kilogram of water, which is roughly 12% of the calorific value of dry wood. Thus if wood consists of $m\%$ moisture, the mass of wood that can effectively heat the pot of water is reduced by roughly $1 - (1.12 * m)$ because the water must be boiled away (see Baldwin, 1986 for further discussion).

The factor of $1.5 * \Delta c_c$ accounts for the wood converted into unburned char. Char has roughly 150% the calorific content of wood, thus the amount of wood heating the pot of water should be adjusted by $1.5 * \Delta c_c$ to account for the remaining char. Note, in the simmer phase it is possible that there will be a net loss in the amount of char before and after the test, in which case $\bullet c$ is negative and the equivalent dry wood increases rather than decreases.

w_{cv} - Water vaporized: This is a measure of the amount of water lost through evaporation during the test. It is calculated by subtracting the final weight of pot and water from the initial weight of pot and water.

$$w_{cv} = P_{ci} - P_{cf}$$

w_{cr} - Water remaining at end of test: This is a measure of the amount of water heated to boiling. It is calculated by subtracting the weight of the pot from the final weight of the pot and water.

$$w_{cr} = P_{cf} - P$$

• t_c – Duration of phase: This is simply the time taken to perform the test. It is a simple clock difference:

$$t_c = t_{cf} - t_{ci}$$

h_c - Thermal efficiency: This is a ratio of the work done by heating and evaporating water to the energy consumed by burning wood. It is calculated in the following way.

$$h_c = \frac{4.186 * (P_{ci} - P) * (T_{cf} - T_{ci}) + 2260 * (w_{cv})}{f_{cd} * LHV}$$

In this calculation, the work done by heating water is determined by adding two quantities: (1) the product of the mass of water in the pot, $(P_{ci} - P)$, the specific heat of water (4.186 J/g°C), and the change in water temperature $(T_{cf} - T_{ci})$ and (2) the product of the amount of water evaporated from the pot and the latent heat of evaporation of water (2,260 J/g). The denominator (bottom of the ratio) is determined by taking the product of the drywood equivalent consumed during this phase of the test and the lower heat value (LHV).

r_{cb} - Burning rate: This is a measure of the rate of wood consumption while bringing water to a boil. It is calculated by dividing the equivalent dry wood consumed by the time of the test.

$$r_{cb} = \frac{f_{cd}}{t_{ci} - t_{cf}}$$

SC_c - Specific fuel consumption: Specific consumption can be defined for any number of cooking tasks and should be considered “the fuelwood required to produce a unit output” whether the output is boiled water, cooked beans, or loaves of bread. In the case of the cold-start high-power WBT, it is a measure of the amount of wood required to produce one liter (or kilo) of boiling water starting with cold stove. It is calculated in this way:

$$SC_c = \frac{f_{cd}}{P_{cf} - P}$$

SC_c^T – Temperature corrected specific fuel consumption: This corrects specific consumption to account for differences in initial water temperatures. This facilitates comparison of stoves tested on different days or in different environmental conditions. The correction is a simple factor that “normalizes” the temperature change observed in test conditions to a “standard” temperature change of 75 °C (from 25 to 100). It is calculated in the following way.

$$SC_c^T = \frac{f_{cd}}{P_{cf} - P} * \frac{75}{T_{cf} - T_{ci}}$$

FP_c – Firepower: This is a ratio of the wood energy consumed by the stove per unit time. It tells the average power output of the stove (in watts) during the high-power test.

$$FP_c = \frac{f_{cd} * LHV}{60 * (t_{ci} - t_{cf})}$$

Note, by using f_{cd} in this calculation, we have accounted for both the remaining char and the wood moisture content.

HOOD Results

3 stone fire **Ghana wood** **20 LCan Rocket** **Mud/Sawdust** **VITA**

1. HIGH POWER TEST (COLD START)		units					
Time to boil Pot # 1	min	28	25	22	20	16	
Burning rate	g/min	24.08	21.03	17.13	24.15	25.18	
Thermal efficiency	%	19%	24%	37%	28%	29%	
Specific fuel consumption	g/L	136.02	106.38	76.70	94.28	83.71	
Temp-corrected specific consumption	g/L	118.44	92.13	68.06	82.02	72.91	
Firepower	watts	7,761	6,774	5,532	7,801	8,129	
Equivalent dry wood consumed	g	511	387.4	395.3	412.5	269.6	
2. HIGH POWER TEST (HOT START)		units					
Time to boil Pot # 1	min	30	22	23	16	15	
Burning rate	g/min	25.61	19.32	18.03	24.86	24.66	
Thermal efficiency	%	20%	27%	31%	31%	31%	
Specific fuel consumption	g/L	136.87	86.67	85.99	83.30	74.97	
Temp-corrected specific consumption	g/L	121.92	76.54	76.18	72.58	67.82	
Firepower	watts	8,243	6,207	5,809	8,004	7,944	
Equivalent dry wood consumed	g	567.6	310.0	416.0	390.9	273.6	
3. LOW POWER (SIMMER)		units					
Burning rate	g/min	9.49	9.91	6.68	6.28	7.15	
Thermal efficiency	%	26%	23%	26%	44%	34%	
Specific fuel consumption	g/L	103.38	114.89	74.41	81.28	67.52	
Firepower	watts	3,130	3,298	2,235	2,078	2,385	
Turn down ratio		2.77	1.99	2.64	3.92	3.85	
Equivalent dry wood consumed	g	419.4	279.1	192.8	221.5	208.8	
4. ENERGY & MOISTURE CONTENT OF FUEL		units					
Net calorific value (dry)	kJ/kg	19,260	19,260	19,260	19,260	19,260	
Moisture content	%	11%	11%	11%	11%	11%	
Effective calorific fuel value	kJ/kg	17,302	17,332	17,332	17,334	17,281	
5. COLD START ADDITIONAL MEASURES		units					
Temp-Corrected time to boil	min	23.8	24	22.7	18.1	14.1	
Energy consumption rate	kJ/min	408	327	261	343	393	
Temp-Corrected specific energy consumption	kJ/L	2,024	1,619	1,262	1,293	1,122	
Total energy consumed	kJ	11,282	8,968	6,853	7,152	6,213	
6. HOT START ADDITIONAL MEASURES		units					
Temp-Corrected time to boil	min	29.6	19.7	21.9	13.9	13.9	
Energy consumption rate	kJ/min	431	318	296	428	412	
Temp-Corrected specific energy consumption	kJ/L	2,160	1,298	1,337	1,223	1,149	
Total energy consumed	kJ	11,766	7,173	7,220	6,784	6,314	
7. SIMMER ADDITIONAL MEASURES		units					
Energy consumption rate	kJ/min	161	143	111	114	107	
Temp-Corrected specific energy consumption	kJ/L	1,807	1,580	1,216	1,364	1,175	
Total energy consumed	kJ	7,625	6,455	4,977	5,137	4,813	

HOOD Results

		Justa	Uganda 2-pot	Patsari Proto- type	Onil	Eco- Stove
1. HIGH POWER TEST (COLD START)						
Time to boil Pot # 1	units					
	min	52	20	42	35	53
Burning rate	g/min	25.41	20.38	25.57	33.58	29.87
Thermal efficiency	%	17%	40%	20%	18%	13%
Specific fuel consumption	g/L	150.86	60.84	123.31	139.95	296.04
Temp-corrected specific consumption	g/L	130.11	52.41	108.29	118.98	260.29
Firepower	watts	8,203	6,577	8,212	10,829	8,998
Equivalent dry wood consumed	g	884.5	265.6	709.2	743.3	1074.4
2. HIGH POWER TEST (HOT START)						
Time to boil Pot # 1	units					
	min	39	15	33	28	34
Burning rate	g/min	29.62	23.50	26.27	32.53	31.84
Thermal efficiency	%	21%	45%	24%	22%	16%
Specific fuel consumption	g/L	151.80	58.63	129.78	131.72	234.21
Temp-corrected specific consumption	g/L	134.75	52.29	114.79	114.77	208.16
Firepower	watts	8,685	7,580	8,439	10,489	9,626
Equivalent dry wood consumed	g	703.2	231.3	529.6	551.8	735.6
3. LOW POWER (SIMMER)						
Burning rate	g/min	12.70	7.71	12.96	14.50	14.67
Thermal efficiency	%	14%	33%	14%	13%	16%
Specific fuel consumption	g/L	140.90	91.71	143.93	160.32	168.50
Firepower	watts	4,180	2,550	4,253	4,796	4,531
Turn down ratio		2.03	3.11	1.99	2.24	2.04
Equivalent dry wood consumed	g	392.5	214.9	401.3	409	448.8
4. ENERGY & MOISTURE CONTENT OF FUEL						
Net calorific value (dry)	kJ/kg	19,260	19,260	19,260	19,260	19,260
Moisture content	%	11%	11%	11%	11%	11%
Effective calorific fuel value	kJ/kg	17,384	17,384	17,384	17,345	17,284
5. COLD START ADDITIONAL MEASURES						
Temp-Corrected time to boil	min	54.5	18.7	40.1	30.4	47.8
Energy consumption rate	kJ/min	363	310	397	541	521
Temp-Corrected specific energy consumption	kJ/L	2,437	843	1,869	1,942	5,338
Total energy consumed	kJ	23,080	6,914	18,530	19,356	28,032
6. HOT START ADDITIONAL MEASURES						
Temp-Corrected time to boil	min	38.9	13.6	29.6	25.6	29.5
Energy consumption rate	kJ/min	420	377	413	489	571
Temp-Corrected specific energy consumption	kJ/L	2,006	759	1,463	1,474	3,642
Total energy consumed	kJ	18,322	6,021	13,811	14,369	19,245
7. SIMMER ADDITIONAL MEASURES						
Energy consumption rate	kJ/min	228	124	233	237	261
Temp-Corrected specific energy consumption	kJ/L	2,493	1,475	2,599	2,592	2,989
Total energy consumed	kJ	10,239	5,609	10,490	10,648	11,734

HOOD Results

		Wood Flame Fan	Wood Gas Fan	Mali Char- coal	Gyapa Char- coal	Pro- pane
1. HIGH POWER TEST (COLD START)						
Time to boil Pot # 1	units					
	min	23	29	38	37	32
Burning rate	g/min	12.68	8.2	11.10	10.97	2.43
Thermal efficiency	%	42%	45%	17%	18%	69%
Specific fuel consumption	g/L	59.37	53.46	88.55	81.28	14.94
Temp-corrected specific consumption	g/L	49.85	47.22	78.31	70.65	12.70
Firepower	watts	4,093	2,656	5,859	5,790	1,946
Equivalent dry wood consumed	g	265.9	206.9	253.2	256.8	66
2. HIGH POWER TEST (HOT START)						
Time to boil Pot # 1	units					
	min	23	29	47	29	30
Burning rate	g/min	12.43	8.5	10.31	12.76	2.40
Thermal efficiency	%	42%	46%	18%	19%	66%
Specific fuel consumption	g/L	58.65	51.05	93.34	75.02	14.86
Temp-corrected specific consumption	g/L	49.66	46.60	83.97	65.95	12.94
Firepower	watts	4,003	2,761	5,443	6,735	1,915
Equivalent dry wood consumed	g	278.8	0.0	272.9	230.9	67
3. LOW POWER (SIMMER)						
Burning rate	g/min	6.21	4.20	4.84	5.89	1.32
Thermal efficiency	%	42%	46%	27%	34%	61%
Specific fuel consumption	g/L	75.4	44.85	53.64	70.54	15.00
Firepower	watts	2,059	1,400	2,586	3,174	1,072
Turn down ratio		1.88	1.97	2.10	2.82	1.89
Equivalent dry wood consumed	g	276.5	0.0	157.9	137.6	41.3
4. ENERGY & MOISTURE CONTENT OF FUEL						
Net calorific value (dry)	kJ/kg	19,260	19,260	31,680	31,680	47,490
Moisture content	%	12%	12%	6%	6%	0%
Effective calorific fuel value	kJ/kg	17,258	17,196	29,983	29,983	47,490
5. COLD START ADDITIONAL MEASURES						
Temp-Corrected time to boil	min	19.6	23.7	34.5	34.0	20.9
Energy consumption rate	kJ/min	200	124	291	289	136
Temp-Corrected specific energy consumption	kJ/L	816	755	2,081	2,035	589
Total energy consumed	kJ	4,587	3,558	11,370	11,540	1,606
6. HOT START ADDITIONAL MEASURES						
Temp-Corrected time to boil	min	19.4	23.7	42.7	22.7	25.0
Energy consumption rate	kJ/min	214	124	297	392	114
Temp-Corrected specific energy consumption	kJ/L	856	755	2,321	1,821	593
Total energy consumed	kJ	4,809	3,558	12,191	10,357	1,631
7. SIMMER ADDITIONAL MEASURES						
Energy consumption rate	kJ/min	106	124	161	141	65
Temp-Corrected specific energy consumption	kJ/L	1,266	1,132	1,759	1,674	743
Total energy consumed	kJ	4,773	5,337	7,259	6,332	2,949

HOOD Results

		Alcohol Clean Cook	Kero- sene	Solar
1. HIGH POWER TEST (COLD START)		units		
Time to boil Pot # 1	min	38	46	76
Burning rate	g/min	4.33	2.73	
Thermal efficiency	%	66%	52%	28%
Specific fuel consumption	g/L	34.44	25.82	
Temp-corrected specific consumption	g/L	28.68	22.25	
Firepower	watts	1,544	1,859	2,386
Equivalent dry wood consumed	g	165.0	114.0	
2. HIGH POWER TEST (HOT START)		units		
Time to boil Pot # 1	min	38	51	77
Burning rate	g/min	4.33	2.56	
Thermal efficiency	%	66%	51%	23%
Specific fuel consumption	g/L	34.44	27.67	
Temp-corrected specific consumption	g/L	28.68	23.75	
Firepower	watts	1,544	1,859	2,386
Equivalent dry wood consumed	g	165.0	113.0	
3. LOW POWER (SIMMER)		units		
Burning rate	g/min	3.09	2.40	
Thermal efficiency	%	59%	40%	
Specific fuel consumption	g/L	34.64	26.37	
Firepower	watts	1,100	1,799	1,383
Turn down ratio		1.40	110	
Equivalent dry wood consumed	g	139.0	96.0	
4. ENERGY & MOISTURE CONTENT OF FUEL		units		
Net calorific value (dry)	kJ/kg	21,370	43,500	
Moisture content	%	0%		
Effective calorific fuel value	kJ/kg	21,370	43,500	
5. COLD START ADDITIONAL MEASURES		units		
Temp-Corrected time to boil	min	31.6	40.7	69.9
Energy consumption rate	kJ/min	93	104	
Temp-Corrected specific energy consumption	kJ/L	613	916	
Total energy consumed	kJ	3,526	4,959	
6. HOT START ADDITIONAL MEASURES		units		
Temp-Corrected time to boil	min	31.6	43.1	70.0
Energy consumption rate	kJ/min	93	105	
Temp-Corrected specific energy consumption	kJ/L	613	911	
Total energy consumed	kJ	3,526	5,307	
7. SIMMER ADDITIONAL MEASURES		units		
Energy consumption rate	kJ/min	66	93	
Temp-Corrected specific energy consumption	kJ/L	740	1,011	
Total energy consumed	kJ	2,970	4,176	

HOOD Results

		3 stone fire	Ghana Wood	20 L Can Rocket	Mud/Sawdust	VITA
Totals						
CO	grams	26.50	29.25	5.27	18.01	24.59
CO2	grams	818	737	836	628	515
HC (propane)	grams (prop)	1.7405	2.0569	0.5386	1.5064	1.5081
appx PM	mg	1793	5294	997	1847	1887
CO/CO2 ratio		0.0572	0.0648	0.0101	0.0478	0.0752
Flame temp	degrees C	485	159	226	155	282
Totals						
CO	grams	28.91	20.22	6.50	16.39	26.19
CO2	grams	934	669	784	523	523
HC (propane)	grams (prop)	2.3698	2.0739	0.7755	1.5788	1.9752
appx PM gr	mg	2004	3751	594	2255	2642
CO/CO2 ratio		0.0533	0.0479	0.0137	0.0523	0.0804
Flame temp	degrees C	300	155	177	164	301
Totals						
CO	grams	31.43	24.71	9.95	29.90	21.88
CO2	grams	815	682	830	735	661
HC (propane)	grams (prop)	3.6547	3.8498	2.6255	4.1328	3.4533
appx PM gr	grams	281	948	MISS	663	421
CO/CO2 ratio		0.0694	0.0594	0.0188	0.0645	0.0525
Flame temp		207	77	121	62	70

(Corrected for water temp and Moisture)

Correction Factor		0.1408				
CO	g/L	3.6351	3.7049	0.8044	2.3990	3.3932
CO2	g/L	112.0006	94.4812	126.7232	82.3402	71.3697
HC (propane)	g/L	0.2385	0.2604	0.0800	0.1990	0.2090
appx PM mg	mg/L	238.2039	652.9593	162.3765	265.2436	283.4517

Correction Factor		0.1446				
CO	g/L	4.0321	2.4414	0.9921	2.2284	3.6219
CO2	g/L	130.2379	82.4174	119.2356	69.2491	72.3851
HC (propane)	g/L	0.3298	0.2511	0.1155	0.2118	0.2757
appx PM mg	mg/L	277.0760	414.9405	95.4476	324.7657	392.1768

Correction Factor		0.2274				
CO	g/L	7.3046	7.0095	2.1654	7.3922	5.0520
CO2	g/L	185.1880	185.2308	180.5102	178.7203	154.5302
HC (propane)	g/L	0.8474	1.0770	0.5715	0.9864	0.8090
appx PM mg	mg/L	214.9977	323.4849	128.9121	175.4471	92.2347

HOOD Results

		Justa	Uganda 2- pot	Patsari Proto- type	Onil	Eco- stove
Totals						
CO	grams	26.93	13.03	16.47	32.89	52.83
CO2	grams	1983	372	1700	1730	2382
HC (propane)	grams (prop)	5.1406	1.4423	2.6841	2.4597	4.1091
appx PM	mg	983	662	903	1437	5535
CO/CO2 ratio		0.0200	0.0539	0.0147	0.0286	0.0349
Flame temp	degrees C	11	12	12	396	13
Totals						
CO	grams	17.40	12.46	13.18	17.19	27.41
CO2	grams	1726	369	1549	1361	1442
HC (propane)	grams (prop)	5.1970	2.0540	3.1776	3.1035	3.1484
appx PM gr	mg	933	813	835	1483	4343
CO/CO2 ratio		0.0148	0.0529	0.0146	0.0193	0.0302
Flame temp	degrees C	13	13	13	442	13
Totals						
CO	grams	12.80	12.87	11.96	18.10	14.06
CO2	grams	1254	654	1010	1141	1077
HC (propane)	grams (prop)	5.8437	4.8623	4.1460	4.2688	4.3466
appx PM gr	grams	340	264	446	671	1044
CO/CO2 ratio		0.0168	0.0304	0.0205	0.0247	0.0201
Flame temp		13	14	12	277	13

(Corrected for water temp and moisture)

Correction Factor		0.1408				
CO	g/L	2.3540	1.1894	1.2863	2.6733	8.1161
CO2	g/L	172.6200	33.9872	132.9404	139.3402	365.8552
HC (propane)	g/L	0.4454	0.1327	0.2106	0.1952	0.6313
appx PM mg	mg/L	83.1819	62.6387	71.8650	111.7469	851.8434

Correction Factor		0.1446				
CO	g/L	1.5561	1.1529	1.0826	1.3988	4.0083
CO2	g/L	153.5459	34.0263	127.0328	109.4260	211.2221
HC (propane)	g/L	0.4603	0.1871	0.2610	0.2401	0.4607
appx PM mg	mg/L	78.5652	72.2213	69.3188	112.0330	642.2649

Correction Factor		0.2274				
CO	g/L	2.8703	3.2840	2.7024	4.2671	3.5458
CO2	g/L	280.5839	166.6359	224.6289	269.0215	266.7382
HC (propane)	g/L	1.3105	1.2417	0.9257	1.0003	1.0712
appx PM mg	mg/L	77.6056	68.1982	105.3058	156.6180	273.3383

HOOD Results

		Wood Flame Fan	Wood Gas Fan	Mali Char- coal	Gyapa Char- coal	Pro- pane
Totals						
CO	grams	6.49	3.64	73.97	105.09	0.64
CO2	grams	510	525	524	665	281
HC (propane)	grams (prop)	1.2411	2.3581	8.0845	7.7670	0.9349
appx PM	mg	6	14	1026	1155	2
CO/CO2 ratio		0.0201	0.0109	0.2219	0.2522	0.0043
Flame temp	degrees C	228	366	181	312	13
Totals						
CO	grams	5.14	3.64	75.57	85.79	0.50
CO2	grams	504	525	577	630	323
HC (propane)	grams (prop)	1.5259	2.3581	10.8352	18.7060	1.5905
appx PM gr	mg	48	14	1149	1656	1
CO/CO2 ratio		0.0182	0.0109	0.2279	0.1579	0.0025
Flame temp	degrees C	251	366	214	360	13
Totals						
CO	grams	4.52	5.46	43.41	56.89	0.02
CO2	grams	664	788	359	522	341
HC (propane)	grams (prop)	3.5576	3.5372	7.8860	10.9529	4.3930
appx PM gr	grams	25	22	162	169	2
CO/CO2 ratio		0.0117	0.0109	0.2251	0.1726	0.0001
Flame temp		180		187	202	11

(Corrected for water temp and moisture)

Correction Factor		0.1408				
CO	g/L	0.9190	0.5488	12.7035	15.5781	0.1164
CO2	g/L	71.9071	79.2075	90.0783	98.5886	50.3029
HC (propane)	g/L	0.1759	0.3557	1.3648	1.1513	0.1661
appx PM mg	mg/L	0.8663	2.1627	50.2483	102.5396	0.2854

Correction Factor		0.1446				
CO	g/L	0.7203	0.5488	13.2394	12.7283	0.0907
CO2	g/L	71.3950	79.2075	102.0851	93.3947	58.1523
HC (propane)	g/L	0.2141	0.3557	1.8575	2.7752	0.2848
appx PM mg	mg/L	6.7223	2.1627	38.6633	96.6982	0.2511

Correction Factor		0.2274				
CO	g/L	1.0222	0.8232	9.5875	12.8843	0.0046
CO2	g/L	152.4690	118.8113	82.6742	118.2473	85.7806
HC (propane)	g/L	0.8266	0.5335	1.7700	2.4806	1.1048
appx PM mg	mg/L	5.7257	3.2441	7.5531	17.7353	0.6331

HOOD Results

		Alcohol-Clean Cook	Kero-sene	Solar
Totals		(cold start)		
CO	grams	2.71	5.43	
CO2	grams	306	409	
HC (propane)	grams (prop)	0.6992	0.7374	
appx PM	mg	2	2	
CO/CO2 ratio		0.0138	0.0208	
Flame temp	degrees C	6	479	
Totals		(hot start)		
CO	grams	2.71	5.06	
CO2	grams	306	434	
HC (propane)	grams (prop)	0.6992	1.6961	
appx PM gr	mg	2	3	
CO/CO2 ratio		0.0138	0.0185	
Flame temp	degrees C	6	341	
Totals		(simmer)		
CO	grams	2.35	3.11	
CO2	grams	350	403	
HC (propane)	grams (prop)	1.3251	2.0206	
appx PM gr	grams	2	5	
CO/CO2 ratio		0.0106	0.0119	
Flame temp		6	317	

(Corrected for water temp and moisture)

Correction Factor		0.1408	
CO	g/L	0.4722	0.8918
CO2	g/L	53.0953	68.2801
HC (propane)	g/L	0.1195	0.1157
appx PM mg	mg/L	0.3072	0.4546

Correction Factor		0.1446	
CO	g/L	0.4722	0.8347
CO2	g/L	53.0953	71.1966
HC (propane)	g/L	0.1195	0.2874
appx PM mg	mg/L	0.3072	0.5829

Correction Factor		0.2274	
CO	g/L	0.5850	0.7004
CO2	g/L	87.0337	94.5210
HC (propane)	g/L	0.3294	0.4944
appx PM mg	mg/L	0.5663	1.3829

HOOD Results

		3 stone fire	Ghana Wood	20 L Can Rocket	Mud/ Sawdust	VITA
Time to Boil (temp-corrected)	min	26.69	21.84	22.29	15.99	14.00
Temp-Corrected Specific Consumption	g/L	120.18	84.33	72.12	77.30	70.37
Temp-Corr Specific Energy Consumption	kJ/L	2,091.87	1,458.46	1,299.32	1,257.74	1,135.57
Firepower	W	8,001.96	6,490.30	5,670.31	7,902.64	8,036.66
Thermal Efficiency	%	0.20	0.25	0.34	0.29	0.30

COOKING TASKS

CO TO Boil	g/L	3.83	3.07	0.90	2.31	3.51
CO To Simmer	g/L	7.30	7.01	2.17	7.39	5.05
CO TO Cook	g/L	11.14	10.08	3.06	9.71	8.56
		0.00	0.00	0.00	0.00	0.00
PM To Boil	mg/L	257.64	533.95	128.91	295.00	337.81
PM to Simmer	mg/L	215.00	323.48	128.91	175.45	92.23
PM to Cook	mg/L	472.64	857.43	257.82	470.45	430.05
CO2 to Boil	g/L	121.12	88.45	122.98	75.79	71.88
CO2 to Simmer	g/L	185.19	185.23	180.51	178.72	154.53
CO2 to Cook	g/L	306.31	273.68	303.49	254.51	226.41
HC to Boil	g/L	0.28	0.26	0.10	0.21	0.24
HC to Simmer	g/L	0.85	1.08	0.57	0.99	0.81
HC to Cook	g/L	1.13	1.33	0.67	1.19	1.05
Average CO/CO2 Ratio for Boil		0.0552	0.0564	0.0119	0.0501	0.0778
CO/CO2 Ratio for Simmer		0.0694	0.0594	0.0188	0.0645	0.0525
Boiling						
EF CO	g/kg	51.40	70.37	14.48	42.78	93.47
EF CO2	g/kg	1,623.05	2,031.03	2,000.21	1,429.53	1,910.97
EF PM	mg/kg	3,519.59	12,884.23	1,976.11	5,123.86	8,327.68
EF HC	g/kg	3.79	6.00	1.61	3.85	6.41

HOOD Results

		Patsari				
		Justa	Uganda 2- pot	Proto- type	Onil	Eco- stove
Time to Boil (temp-corrected)	min	46.73	16.17	34.82	28.00	38.63
Temp-Corrected Specific Consumption	g/L	132.43	52.35	111.54	116.87	234.23
Temp-Corr Specific Energy Consumption	kJ/L	2,221.74	800.88	1,666.19	1,708.19	4,490.09
Firepower	W	8,444.21	7,078.41	8,325.55	10,663.36	9,312.02
Thermal Efficiency	%	0.19	0.43	0.22	0.20	0.15

COOKING TASKS

CO TO Boil	g/L	1.96	1.17	1.18	2.04	6.06
CO To Simmer	g/L	2.87	3.28	2.70	4.27	3.55
CO TO Cook	g/L	4.83	4.46	3.89	6.30	9.61
		0.00	0.00	0.00	0.00	0.00
PM To Boil	mg/L	80.87	67.43	70.59	111.89	747.05
PM to Simmer	mg/L	77.61	68.20	105.31	156.62	273.34
PM to Cook	mg/L	158.48	135.63	175.90	268.51	1,020.39
CO2 to Boil	g/L	163.08	34.01	129.99	124.38	288.54
CO2 to Simmer	g/L	280.58	166.64	224.63	269.02	266.74
CO2 to Cook	g/L	443.67	200.64	354.62	393.40	555.28
HC to Boil	g/L	0.45	0.16	0.24	0.22	0.55
HC to Simmer	g/L	1.31	1.24	0.93	1.00	1.07
HC to Cook	g/L	1.76	1.40	1.16	1.22	1.62
Average CO/CO2 Ratio for Boil		0.0174	0.0534	0.0147	0.0239	0.0325
CO/CO2 Ratio for Simmer		0.0168	0.0304	0.0205	0.0247	0.0201
Boiling						
EF CO	g/kg	27.60	51.47	24.06	37.70	43.21
EF CO2	g/kg	2,348.28	1,497.56	2,660.75	2,397.11	2,088.72
EF PM	mg/kg	1,219.54	3,005.25	1,425.69	2,310.11	5,527.62
EF HC	g/kg	6.60	7.16	4.89	4.47	4.05

HOOD Results

		Wood Flame	Wood Gas Fan	Mali Char- coal	Gyapa Char- coal	Pro- pane
Time to Boil (temp-corrected)	min	19.50	23.75	38.62	28.35	22.98
Temp-Corrected Specific Consumption	g/L	49.76	46.91	81.14	68.30	12.82
Temp-Corr Specific Energy Consumption	kJ/L	836.17	754.73	2,200.86	1,928.27	590.92
Firepower	W	4,047.99	2,708.92	5,650.63	6,262.64	1,930.36
Thermal Efficiency	%	0.42	0.45	0.18	0.18	0.68

COOKING TASKS

CO TO Boil	g/L	0.82	0.55	12.97	14.15	0.10
CO To Simmer	g/L	1.02	0.82	9.59	12.88	0.00
CO TO Cook	g/L	1.84	1.37	22.56	27.04	0.11
		0.00	0.00	0.00	0.00	0.00
PM To Boil	mg/L	3.79	2.16	44.46	99.62	0.27
PM to Simmer	mg/L	5.73	3.24	7.55	17.74	0.63
PM to Cook	mg/L	9.52	5.41	52.01	117.35	0.90
CO2 to Boil	g/L	71.65	79.21	96.08	95.99	54.23
CO2 to Simmer	g/L	152.47	118.81	82.67	118.25	85.78
CO2 to Cook	g/L	224.12	198.02	178.76	214.24	140.01
HC to Boil	g/L	0.19	0.36	1.61	1.96	0.23
HC to Simmer	g/L	0.83	0.53	1.77	2.48	1.10
HC to Cook	g/L	1.02	0.89	3.38	4.44	1.33
Average CO/CO2 Ratio for Boil		0.0192	0.0109	0.2249	0.2050	0.0034
CO/CO2 Ratio for Simmer		0.0117	0.0109	0.2251	0.1726	0.0001
Boiling						
EF CO	g/kg	21.42	17.59	284.53	390.40	8.62
EF CO2	g/kg	1,863.01	2,538.40	2,091.55	2,658.17	4,542.56
EF PM	mg/kg	98.36	69.31	4,131.65	5,834.94	21.85
EF HC	g/kg	5.07	11.40	35.82	55.63	18.95

HOOD Results

		Alcohol- Clean Cook	Kero- sene	Solar
Time to Boil (temp-corrected)	min	31.62	41.89	69.95
Temp-Corrected Specific Consumption	g/L	28.68	23.00	
Temp-Corr Specific Energy Consumption	kJ/L	612.83	913.49	
Firepower	W	1,543.64	1,917.90	2,236.41
Thermal Efficiency	%	0.66	0.52	0.25

COOKING TASKS

CO TO Boil	g/L	0.47	0.86	0.00
CO To Simmer	g/L	0.59	0.70	0.00
CO TO Cook	g/L	1.06	1.56	0.00
			0.00	0.00
PM To Boil	mg/L	0.31	0.52	0.00
PM to Simmer	mg/L	0.57	1.38	0.00
PM to Cook	mg/L	0.87	1.90	0.00
CO2 to Boil	g/L	53.10	69.74	0.00
CO2 to Simmer	g/L	87.03	94.52	0.00
CO2 to Cook	g/L	140.13	164.26	0.00
				0.00
HC to Boil	g/L	0.12	0.20	0.00
HC to Simmer	g/L	0.33	0.49	0.00
HC to Cook	g/L	0.45	0.70	0.00
Average CO/CO2 Ratio for Boil		0.0138	0.0197	
CO/CO2 Ratio for Simmer		0.0106	0.0119	
Boiling				
EF CO	g/kg	16.41	46.24	
EF CO2	g/kg	1,852.21	3,714.77	
EF PM	mg/kg	10.87	24.81	
EF HC	g/kg	4.24	10.74	

WBT Results

AVERAGES

Chimney

	3 stone fire	Ghana Wood	20L Can Rocket	Mud / Sawdust	VITA	Justa
1. HIGH POWER TEST (COLD START)	Average	Average	Average	Average	Average	Average
Time to boil Pot # 1	21.03	20.45	17.10	18.46	14.33	28.30
Burning rate	33.10	22.03	19.23	28.35	25.96	34.57
Thermal efficiency	0.16	0.24	0.54	0.25	0.29	0.19
Specific fuel consumption	145.98	93.11	65.22	102.94	76.31	123.75
Temp-corrected specific consumption	139.13	84.94	57.17	91.67	71.16	109.99
Firepower	10,756	7,086	6,248	9,211	8,435	1,1232
2. HIGH POWER TEST (HOT START)	Average	Average	Average	Average	Average	Average
Time to boil Pot # 1	19.67	19.33	18.49	17.42	13.20	28.03
Burning rate	28.78	22.38	20.88	25.51	27.26	32.48
Thermal efficiency	0.21	0.25	0.35	0.31	0.29	0.25
Specific fuel consumption	117.14	89.50	84.31	89.11	73.37	190.05
Temp-corrected specific consumption	110.62	81.82	73.78	78.93	72.11	173.15
Firepower	9,354	7,199	6,784	8,289	8,857	10,554
3. LOW POWER (SIMMER)	Average	Average	Average	Average	Average	Average
Burning rate	8.83	16.86	7.28	7.00	5.95	11.94
Thermal efficiency	0.22	0.12	0.24	0.47	0.34	0.17
Specific fuel consumption	99.59	186.47	81.88	90.03	66.16	136.05
Firepower	3,062	5,793	2,525	2,427	2,063	4,141
Turn down ratio	3.15	1.27	2.71	4.07	4.28	2.55

Standard Deviations

Chimney

	3 stone fire	Ghana Wood	20L Can Rocket	Mud/Saw dust	VITA	Justa
1. HIGH POWER TEST (COLD START)	St Dev	St Dev	St Dev	St Dev	St Dev	St Dev
Time to boil Pot # 1	2.25	0.83	3.53	4.72	1.53	3.57
Burning rate	1.37	1.25	10.39	10.15	5.11	0.82
Thermal efficiency	0.02	0.02	0.50	0.06	0.03	0.02
Specific fuel consumption	21.25	6.90	32.46	11.98	13.42	14.78
Temp-corrected specific consumption	18.17	4.45	28.10	16.26	10.70	11.57
Firepower	447	408	3,377	3,297	1,660	268
2. HIGH POWER TEST (HOT START)	St Dev	St Dev	St Dev	St Dev	St Dev	St Dev
Time to boil Pot # 1	2.25	1.46	3.43	3.76	1.51	2.93
Burning rate	7.05	2.01	5.12	8.99	6.93	2.96
Thermal efficiency	0.03	0.01	0.10	0.09	0.03	0.09
Specific fuel consumption	22.22	8.38	35.43	18.70	12.46	9.72
Temp-corrected specific consumption	21.71	6.36	31.63	20.05	8.24	11.20
Firepower	2,290	653	1,662	2,921	2,252	962
3. LOW POWER (SIMMER)	St Dev	St Dev	St Dev	St Dev	St Dev	St Dev
Burning rate	1.16	2.60	1.59	3.09	0.28	0.72
Thermal efficiency	0.01	0.02	0.03	0.16	0.06	0.00
Specific fuel consumption	15.53	27.86	21.46	48.05	5.01	8.95
Firepower	402	882	552	1,071	98	250
Turn down ratio	1.09	0.25	0.44	2.03	0.99	0.24

WBT Results

AVERAGES

	<u>Chimney Stoves</u>				<u>Electric Fan</u>	
	Uganda 2- pot	Patsari Proto- type	Onil	Ecostove	Wood Flame Fan	Wood Gas Fan
1. HIGH POWER TEST (COLD START)	Average	Average	Average	Average	Average	Average
Time to boil Pot # 1	15.00	30.93	33.17	52.23	22.33	31.50
Burning rate	25.51	31.15	38.28	29.59	13.96	8.24
Thermal efficiency	0.36	0.20	0.16	0.21	0.40	0.44
Specific fuel consumption	64.62	118.89	149.06	193.44	63.83	53.68
Temp-corrected specific consumption	60.15	110.16	133.10	167.23	52.01	48.74
Firepower	8,288	10,018	12,439	7,733	4,535	2,678
2. HIGH POWER TEST (HOT START)	Average	Average	Average	Average	Average	Average
Time to boil Pot # 1	12.83	29.33	22.53	36.77	23.50	28.90
Burning rate	27.06	31.36	41.09	29.96	12.51	8.50
Thermal efficiency	0.39	0.21	0.19	0.24	0.41	0.46
Specific fuel consumption	71.52	191.81	192.76	235.03	60.68	51.05
Temp-corrected specific consumption	69.46	176.12	174.32	206.79	49.83	46.60
Firepower	8,794	10,087	13,354	7,830	4,065	2,761
3. LOW POWER (SIMMER)	Average	Average	Average	Average	Average	Average
Burning rate	8.79	12.14	16.24	14.08	6.84	4.03
Thermal efficiency	0.31	0.14	0.12	0.19	0.39	0.46
Specific fuel consumption	105.59	133.44	182.16	162.54	81.66	44.85
Firepower	3,050	4,170	5,635	3,988	2,372	1,400
Turn down ratio	2.93	2.46	2.37	2.03	1.72	1.97

Standard Deviations

	<u>Chimney Stoves</u>				<u>Electric Fan</u>	
	Uganda 2 Pot	Patsari Prototype	Onil	Ecostove	Wood Flame Fan	Wood GasFan
1. HIGH POWER TEST (COLD START)	St Dev	St Dev	St Dev	St Dev	St Dev	St Dev
Time to boil Pot # 1	1.00	1.44	2.02	5.35	1.53	4.86
Burning rate	2.73	2.35	1.37	3.33	3.93	0.90
Thermal efficiency	0.05	0.01	0.00	0.01	0.09	0.05
Specific fuel consumption	5.59	6.25	2.48	8.42	14.47	6.84
Temp-corrected specific consumption	5.01	8.74	4.92	4.52	12.27	5.82
Firepower	887	750	444	870	1,276	294
2. HIGH POWER TEST (HOT START)	St Dev	St Dev	St Dev	St Dev	St Dev	St Dev
Time to boil Pot # 1	1.89	4.35	0.46	2.12	1.80	2.62
Burning rate	4.32	3.03	2.39	2.34	1.23	0.37
Thermal efficiency	0.03	0.01	0.01	0.02	0.01	0.01
Specific fuel consumption	3.97	13.87	6.76	6.87	1.90	2.79
Temp-corrected specific consumption	5.74	16.42	6.36	14.08	2.47	2.62
Firepower	1,403	979	775	611	400	121
3. LOW POWER (SIMMER)	St Dev	St Dev	St Dev	St Dev	St Dev	St Dev
Burning rate	0.86	1.45	0.47	2.84	0.36	0.12
Thermal efficiency	0.02	0.01	0.02	0.04	0.03	0.02
Specific fuel consumption	12.24	15.97	2.16	32.33	3.83	1.73
Firepower	297	502	162	804	127	43
Turn down ratio	0.74	0.50	0.07	0.53	0.23	0.10

WBT Results

AVERAGES

	<u>Charcoal</u>		<u>Other Fuels</u>		
	Mali Charcoal	Gyapa Charcoal	Propane	Alcohol - Clean Cook*	Kerosene
1. HIGH POWER TEST (COLD START)	Average	Average	Average	Average	Average
Time to boil Pot # 1	36.70	29.77	30.58		51.57
Burning rate	13.76	13.58	2.45		2.65
Thermal efficiency	0.15	0.17	0.66		0.59
Specific fuel consumption	107.43	83.75	14.57		31.90
Temp-corrected specific consumption	96.31	76.32	12.61		28.05
Firepower	7,267	7,169	1,986		1,920
2. HIGH POWER TEST (HOT START)	Average	Average	Average	Average	Average
Time to boil Pot # 1	42.93	33.40	32.00		50.67
Burning rate	11.49	11.97	2.38		3.05
Thermal efficiency	0.16	0.18	0.62		0.52
Specific fuel consumption	104.58	82.83	15.89		36.77
Temp-corrected specific consumption	96.17	76.21	13.84		32.16
Firepower	6,066	6,323	1,934		2,209
3. LOW POWER (SIMMER)	Average	Average	Average	Average	Average
Burning rate	4.00	8.50	1.23		2.91
Thermal efficiency	0.28	0.18	0.61		0.37
Specific fuel consumption	46.04	102.49	13.75		35.74
Firepower	2,200	4,677	1,028		2,256
Turn down ratio	2.78	1.53	1.93		0.98

* Initial WBT tests of the Alcohol- Clean Cook stove were dismissed after receiving an improved model in Dec. 2006

Standard Deviations

	<u>Charcoal</u>		<u>Other Fuels</u>		
	Mali Charcoal	Gyapa Charcoal	Propane	Alcohol - Clean Cook*	Kerosene
1. HIGH POWER TEST (COLD START)	St Dev	St Dev	St Dev	St Dev	St Dev
Time to boil Pot # 1	2.29	2.36	9.36		4.99
Burning rate	0.23	1.13	0.69		0.12
Thermal efficiency	0.01	0.01	0.02		0.22
Specific fuel consumption	6.27	7.29	0.90		1.79
Temp-corrected specific consumption	5.35	7.02	0.43		1.70
Firepower	120	599	561		84
2. HIGH POWER TEST (HOT START)	St Dev	St Dev	St Dev	St Dev	St Dev
Time to boil Pot # 1	5.29	3.86	3.00		3.62
Burning rate	0.94	1.52	0.13		0.65
Thermal efficiency	0.01	0.02	0.06		0.11
Specific fuel consumption	3.82	4.61	0.75		11.58
Temp-corrected specific consumption	5.31	7.81	1.15		10.76
Firepower	494	803	107		471
3. LOW POWER (SIMMER)	St Dev	St Dev	St Dev	St Dev	St Dev
Burning rate	0.50	2.96	0.25		0.15
Thermal efficiency	0.04	0.03	0.10		0.05
Specific fuel consumption	5.99	40.39	2.84		1.83
Firepower	275	1627	208		113
Turn down ratio	0.31	0.80	0.36		0.19

* Initial WBT tests of the Alcohol- Clean Cook stove were dismissed after receiving an improved model in Dec. 2006

TEST KITCHEN Results

AVERAGES

	3 stone fire	Ghana Wood	20 L Can Rocket	Mud/Saw- dust	VITA
1. HIGH POWER TEST (COLD START)	Average	Average	Average	Average	Average
Time to boil Pot # 1	36.00	20.99	16.27	15.97	18.33
Burning rate	17.08	26.58	21.33	33.10	31.82
Thermal efficiency	0.22	0.21	0.31	0.22	0.20
Specific fuel consumption	125.76	114.76	70.57	107.80	118.80
Temp-corrected specific consumption	103.04	95.98	64.85	94.82	98.73
Firepower	5,549	8,637	6,930	10,755	10,339
3. LOW POWER (SIMMER)	Average	Average	Average	Average	Average
Burning rate	10.81	7.88	6.59	4.73	11.25
Thermal efficiency	0.27	0.37	0.25	0.57	0.45
Specific fuel consumption	82.22	58.99	45.15	34.03	96.28
Firepower	3,752	2,734	2,288	1,640	3,902
Turn down ratio	-	-	-	-	-

STANDARD Deviations

	3 stone fire	Ghana Wood	20 L Can Rocket	Mud/Saw- dust	VITA
1. HIGH POWER TEST (COLD START)	St Dev	St Dev	St Dev	St Dev	St Dev
Time to boil Pot # 1	9.17	1.86	1.96	2.76	3.21
Burning rate	4.55	5.13	4.32	12.24	6.91
Thermal efficiency	0.01	0.04	0.02	0.05	0.02
Specific fuel consumption	3.52	13.98	5.34	31.25	6.81
Temp-corrected specific consumption	1.24	15.00	4.52	24.36	9.97
Firepower	1,479	1,668	1,404	3,977	2,244
3. LOW POWER (SIMMER)	St Dev	St Dev	St Dev	St Dev	St Dev
Burning rate	0.33	3.56	1.19	0.99	1.76
Thermal efficiency	0.03	0.08	0.02	0.28	0.04
Specific fuel consumption	3.13	30.53	8.49	6.65	20.60
Firepower	114	1235	413	344	612
Turn down ratio	-	-	-	-	-

TEST KITCHEN Results

AVERAGES

	<u>Electric Fan</u>		<u>Other Fuels</u>		
	Wood Flame Fan	Wood Gas Fan	Propane	Alcohol - Clean Cook	Kerosene
1. HIGH POWER TEST (COLD START)	Average	Average	Average	Average	Average
Time to boil Pot # 1	22.00	27.94	47.50	59.33	35.38
Burning rate	14.65	9.17	1.56	3.67	3.33
Thermal efficiency	0.37	0.45	0.76	0.55	0.47
Specific fuel consumption	67.64	53.61	16.60	49.66	22.99
Temp-corrected specific consumption	55.30	49.04	13.38	41.43	20.24
Firepower	4,759	2,979	1,265	1,218	2,415
3. LOW POWER (SIMMER)	Average	Average	Average	Average	Average
Burning rate	5.73	4.37	1.30	4.00	2.71
Thermal efficiency	0.50	0.45	0.63	0.53	0.27
Specific fuel consumption	42.47	30.98	9.36	29.06	17.27
Firepower	1,988	1,518	1,084	1,513	2,097
Turn down ratio	-	-	-	-	-

STANDARD Deviations

	<u>Electric Fan</u>		<u>Other Fuels</u>		
	Wood Flame Fan	Wood Gas Fan	Propane	Alcohol - Clean Cook	Kerosene
1. HIGH POWER TEST (COLD START)	St Dev	St Dev	St Dev	St Dev	St Dev
Time to boil Pot # 1	2.83	0.92	9.19	10.07	12.90
Burning rate	0.01	0.44	0.41	0.27	1.22
Thermal efficiency	0.04	0.05	0.30	0.00	0.01
Specific fuel consumption	8.90	1.92	7.67	7.79	0.10
Temp-corrected specific consumption	7.03	3.07	6.37	3.67	0.11
Firepower	2	143	335	88	881
3. LOW POWER (SIMMER)	St Dev	St Dev	St Dev	St Dev	St Dev
Burning rate	0.21	0.60	0.05	-	0.06
Thermal efficiency	0.00	0.02	0.02	0.04	0.12
Specific fuel consumption	1.45	4.55	0.52	0.10	2.38
Firepower	74	209	39	0	43
Turn down ratio	-	-	-	-	-

Overall Variations

	Average	Maximum	# of Tests	3 stone fire	Ghana Wood	20 L Can Rocket	Mud/Sawdust	VITA
Cold Temp Corr Time to Boil	15%	30%	9	21%	15%	16%	14%	18%
Hot Temp Corr Time to Boil	22%	54%	9	54%	2%	34%	13%	20%
Cold Firepower	22%	33%	9	28%	23%	22%	28%	20%
Hot Firepower	21%	49%	9	49%	16%	12%	17%	23%
Simmer Firepower	25%	51%	9	34%	43%	10%	33%	36%
Cold Specific Consumption	17%	32%	9	29%	18%	27%	14%	20%
Hot Specific Consumption	23%	46%	9	36%	15%	26%	15%	14%
Simmer Specific Consumption	24%	50%	9	37%	43%	9%	39%	11%
Cold CO per L	33%	73%	3	23%	45%	25%	18%	9%
Hot CO per L	36%	87%	3	47%	23%	45%	51%	31%
Simmer CO per L	36%	87%	3	34%	36%	18%	37%	25%

Coefficient of Variation = Standard Deviation / Average

Includes different testers, different times of year.

Most of the CO variability is in the chimney stoves

Due to problems in test phases of the Wood Gas and Alcohol Stoves, variation are not reported

	Justa	Uganda 2-pot	Patsari proto-type	Onil	Eco-stove	Wood Flame Fan	Wood Gas Fan	Mali Char-coal
Cold Temp Corr Time to Boil	5%	30%	2%	30%	17%	9%		18%
Hot Temp Corr Time to Boil	26%	12%	25%	35%	13%	14%		54%
Cold Firepower	33%	24%	26%	16%	14%	14%		23%
Hot Firepower	22%	24%	25%	27%	29%	8%		32%
Simmer Firepower	5%	19%	22%	16%	28%	12%		44%
Cold Specific Consumption	14%	16%	16%	11%	32%	14%		20%
Hot Specific Consumption	27%	30%	46%	45%	30%	4%		16%
Simmer Specific Consumption	6%	16%	20%	13%	24%	13%		43%
Cold CO per L	73%	49%	52%	65%	2%	26%		22%
Hot CO per L	79%	23%	36%	56%	3%	87%		13%
Simmer CO per L	25%	37%	12%	44%	60%	87%		63%

Coefficient of Variation = Standard Deviation / Average

Includes different testers, different times of year.

Most of the CO variability is in the chimney stoves

Due to problems in test phases of the Wood Gas and Alcohol Stoves, variation are not reported

Overall Variations

	Gyapa Char- coal	Pro- pane	Alcohol- Clean Cook	Kero- sene
Cold Temp Corrected Time to Boil	12%	3%		12%
Hot Temp Corrected Time to Boil	12%	10%		1%
Cold Firepower	21%	24%		14%
Hot Firepower	12%	5%		14%
Simmer Firepower	51%	8%		21%
Cold Specific Consumption	7%	4%		17%
Hot Specific Consumption	14%	6%		24%
Simmer Specific Consumption	50%	11%		24%
Cold CO per L	17%	41%		10%
Hot CO per L	8%	5%		0%
Simmer CO per L	7%	22%		62%

Coefficient of Variation = Standard Deviation / Average

Includes different testers, different times of year.

Most of the CO variability is in the chimney stoves

Due to problems in test phases of the Wood Gas and Alcohol Stoves, variation are not reported

Solar Cooker Tests

	Time	12 to 1:00	1 to 2:00	2 to 3:00	3 to 4:00	
Average Record		843	860	806	702	Watthr/m2 1.477 m2
multiplied by 1.477 m2 (area of solar cooker)						
Solar Energy		<u>1244</u>	<u>1271</u>	<u>1190</u>	<u>1037</u>	<u>Watthour</u>

Test 1 8/22/2004

	start	end				
Cold start	12:30	1:27	Minutes	30	27	
	17.4	99.2	Temp			
	5,840	5,610	g water			
			Firepower	2,489	2,824	Average
Hot start	1:47	3:10	Minutes	13	60	10
	18.1	99.2	Temp			
	5,840.0	5,582.0	g water			
			Firepower	5,865	1190	6,223 Average
Simmer	3:10	3:55	Minutes			45
			Firepower			1,383 Average

Test 2 8/23/2004

	start	end				
Cold start	12:40	1:52	Minutes	20	52	
	18.1	99.2	Temp			
	5,840	5,607	g water			
			Firepower	3,733	1,466	Average
Hot start'	2:05	3:18	Minutes		55	18
	15.9	99.2	Temp			
	5,840	5,684	g water			
			Firepower		1,298	3,457 Average
Simmer	3:18	4:03	Minutes			45
			Firepower			1,383 Average

Test 3 8/24/2004

	start	end				
Cold start	12:12	1:52	Minutes	48	52	
	16.1	99.2	Temp			
	5,840	5,614	g water			
			Firepower	1,556	1,466	Average
Hot start'	1:52	3:07	Minutes	8	60	7
	15.4	99.2	Temp			
	5,840	5,690	g water			
			Firepower		9,530	1,190 8,890 Average
Simmer	3:07	3:52	Minutes			45
			Firepower			1,383 Average

Test 1		8/22/2004			
	start	end	Firepower		
Cold start	12:30	1:27	Minutes		
	17.4	99.2	Temp		
	5,840	5,610	g water		
			Firepower	2,656 W hot start	57 min
				28% Efficiency cold start	
Hot start	1:47	3:10	Minutes		
	18.1	99.2	Temp		
	5,840.0	5,582.0	g water		
			Firepower	2,528 W cold star	83 min
				20% Efficiency hot start	
Simmer	3:10	3:55	Minutes		
			Firepower	1,383 W simmer	45 min
Test 2		8/23/2004			
	start	end	Firepower		
Cold start	12:40	1:52	Minutes		
	18.1	99.2	Temp		
	5,840	5,607	g water		
			Firepower	2,096 W hot start	72 min
				28% Efficiency cold start	
Hot start	2:05	3:18	Minutes		
	15.9	99.2	Temp		
	5,840	5,684	g water		
			Firepower	1,830 W cold star	73 min
				30% Efficiency hot start	
Simmer	3:18	4:03	Minutes		
			Firepower	1,383 W simmer	45 min
Test 3		8/24/2004			
	start	end	Firepower		
Cold start	12:12	1:52	Minutes		
	16.1	99.2	Temp		
	5,840	5,614	g water		
			Firepower	1,509 W hot start	100 min
				28% Efficiency cold start	
Hot start	1:52	3:07	Minutes		
	15.4	99.2	Temp		
	5,840	5,690	g water		
			Firepower	2,798 W cold star	75 min
				19% Efficiency hot start	
Simmer	3:07	3:52	Minutes		
			Firepower	1,383 W simmer	45 min

Average cold start firepower **2,087 W** **76 min**
 Average hot start firepower **2,386 W** **77 min**
 Average simmer firepower **1,383 W** **45 min**

Average cold start Efficiency 21%
 Average hot start efficiency 23%

Average boil firepower	2,236 Watts
Average boil efficiency	22%

Safety Ratings

A method for evaluating safety, proposed by Nathan Johnson¹⁰ of Iowa State University, was used to evaluate safety in these stoves, in this case without the weighted rankings his system suggests. Each of the following criteria were rated as excellent (4 points), good (3 points), fair (2 points) or poor (1 point) for safety evaluation.

Results of Evaluation:

No.	Name										
1	Sharp Edges/Points										
2	Cookstove Tipping										
3	Containment of Combustion										
4	Expulsion of Fuel										
5	Obstructions Near Cooking Surface										
6	Surface Temperature										
7	Heat Transfer to Surroundings										
8	Cookstove Handle Temperature										
9	Flames/Heat Surrounding Cookpot										
10	Flames/Head Exiting Fuel Chamber										

Stove	1	2	3	4	5	6	7	8	9	10	Total
Onil	4	4	4	4	4	3	4	4	4	4	39
Patsari Prototype	2	4	4	4	2	4	4	4	4	4	36
Justa	4	4	4	4	2	4	4	4	4	4	38
Ecostove	2	3	4	4	3	2	4	4	4	4	34
Uganda 2-pot	4	3	4	4	4	2	4	4	4	4	37
Wood Flame	4	2	3	4	4	3	4	4	3	4	35
Propane	4	1	4	4	4	4	4	4	2	2	33
Kerosene	4	2	3	4	3	3	4	4	4	4	35
Alcohol	4	3	4	4	4	4	4	4	3	3	37
Mali Charcoal	4	2	3	4	3	2	4	3	4	4	33
Wood Gas	4	1	3	4	4	3	4	2	4	4	33
Mud/Sawdust	4	2	2	3	4	3	4	4	3	4	33
20L Can Rocket	2	2	3	4	4	2	4	4	4	4	33
Ghana Wood	4	2	2	3	4	2	4	4	3	4	32
Ghana Charcoal	4	2	2	3	4	2	4	3	4	4	32
VITA	2	2	3	3	4	1	3	4	3	4	29
3 Stone fire	4	1	2	1	4	1	2	4	1	1	21
Solar Cooker*	2	4	4	4	4	2	1	4	4	3	32

(*) Even though no flames are present, focal point solar cooker is extremely hot when uncovered and spontaneous combustion may occur if not careful.

¹⁰ Nathan Johnson graduate thesis (Iowa State University 2005). See <http://www.vrac.iastate.edu/~atlas/safety.htm>.

Safety Evaluation Procedures

For further details on this safety evaluation method go to <http://www.vrac.iastate.edu/~atlas/safety.htm>.

Stove _____	Location _____
Tester _____	Date _____

1. SHARP EDGES AND POINTS

Equipment: Cloth, rag, or loose clothing

Procedure:

- a) Rub cloth along exterior surfaces.
- b) Note number of times cloth catches / tears.

Rating	No. of catches	No. _____		
Poor (1)	four or more	<table border="1" style="border-collapse: collapse; width: 100px; height: 40px;"> <tr> <td style="padding: 5px;">Result 1</td> <td style="border-left: 1px dashed black; width: 20px;"></td> </tr> </table>	Result 1	
Result 1				
Fair (2)	three			
Good (3)	one or two			
Best (4)	none			

2. COOKSTOVE TIPPING

(immobile cook stoves get Best rating)

Equipment: Fuel, ruler / tape measure, calculator

Procedure:

- a) Set stove on flat surface and load with fuel but do not ignite.
- b) Pick a side to tip towards and measure the height of its tallest point, place value into Table A.
- c) Slowly tip cookstove in the outward direction from the side chosen until the stove begins to tip on its own.
- d) Hold stove tilted where it can overturn and measure new height of the point chosen in part 'b', place value into Table A.
- e) Using a calculator, divide the tipped height by the standing height to find the ratio R, place into Table A.
- f) Repeat process as many times as there are legs on the stove (or four times for a circular base).
- g) Use the largest ratio in Table A with the metric in Table B to find the most deficient rating for the result.

Run	Starting Height	Tipped Height	Ratio
1	—	—	—
2	—	—	—
3	—	—	—
4	—	—	—
5	—	—	—
6	—	—	—

Rating	No. of catches
Poor (1)	$R > 0.978$
Fair (2)	$0.961 < R < 0.978$
Good (3)	$0.940 < R < 0.961$
Best (4)	$R < 0.940$

Result 2	
----------	--

3. CONTAINMENT OF FUEL

(solar stoves receive Best rating)

Equipment: Fuel, ruler / tape measure, cookpot

Procedure:

- a) The cookstove should be stocked with fuel but not ignited.
- b) Place cookpot onto burner.
- c) Sum approximate areas through which fuel can be seen.
- d) Use the summation of area, A, to find the rating.

Rating	No. of catches
Poor	$A \geq 250$
Fair	$150 \leq A < 250$
Good	$50 \leq A < 150$
Best	$A < 50$

Area _____

Result 3	
----------	--

Notes:

4. OBSTRUCTIONS NEAR COOKING SURFACE

(skirt-stove = Good; solar = Best)

Equipment: Ruler / tape measure

Procedure:

- a) Inspect cookstove for skirt, do not perform if skirt is present.
- b) Measure height difference between the cooking surface and obstructions surrounding the cooking surface.
- c) Use the largest height difference, D, to find the rating.

Rating	No. of catches
Poor	$D \geq 4$
Fair	$2.5 \leq D < 4$
Good	$1 \leq D < 2.5$
Best	$D < 1$

Largest _____

Result 4	
----------	--

Notes:

**5. SURFACE TEMPERATURE; 6. HEAT TRANSMISSION TO SURROUNDINGS;
7. TEMPERATURE OF OPERATIONAL CONSTRUCTION**

(solar Result 6 = Poor)

Equipment: Fuel, igniter, chalk, ruler / tape measure, hand-held thermocouple

Procedure:

- a) Chalk 8 x 8 cm grid onto cookstove and also within an outline of cook stove on the floor if within 5 cm of undercarriage, and within an outline of cookstove onto the wall if within 10 cm, while continuing the grid 16 cm higher up the wall than the top of the cookstove, if stove is mounted to floor or wall, take supplementary wall and floor temperatures by using cookstove surface temperature near where it attaches to floor or wall. b) Chalk extra thick lines at 0.9m and 1.5m onto cookstove, if applicable. c) Ignite fuel and continue up to step 'g' then wait at that step until cookstove has reached max temp (~20 min) before proceeding, adding fuel when necessary. d) Use the largest height difference, D, to find the rating. e) Measure air temp. f) Compute values for Tables B by adding air temp to temps located in Tables A. g) Take data using thermocouple at grid intersections. h) Start with wall and floor by moving cookstove away to take measurements for up to one minute, then return cookstove for at least 5 minutes, taking surface temp and operational construction temp data while waiting, repeat step 'h' until all data points have been checked. i) Find maximum temperatures for all scenarios. j) Find which rating is given by the maximum temperature using Tables B. k) Use most deficient ratings for the results.

Air Temp _____

SURFACE TEMPERATURE

		<i>Below child-line (< 0.9m)</i>		<i>Below child-line (< 0.9m)</i>	
Rating		Metallic	Nonmetallic	Metallic	Nonmetallic
5A	Poor	$T \geq 50$	$T \geq 58$	$T \geq 66$	$T \geq 74$
	Fair	$44 \leq T < 50$	$52 \geq T < 58$	$60 \geq T < 66$	$68 \geq T < 74$
	Good	$38 \leq T < 44$	$46 \leq T < 55$	$54 \leq T < 60$	$62 \leq T < 68$
	Best	$T < 38$	$T < 46$	$T < 54$	$T < 62$
5B	Poor	$T \geq _$	$T \geq _$	$T \geq _$	$T \geq _$
	Fair	$_ \leq T < _$	$_ \leq T < _$	$_ \leq T < _$	$_ \leq T < _$
	Good	$_ \leq T < _$	$_ \leq T < _$	$_ \leq T < _$	$_ \leq T < _$
	Best	$T < _$	$T < _$	$T < _$	$T < _$
Max/Rating		$_ / _$	$_ / _$	$_ / _$	$_ / _$

HEAT TRANSFER TO THE ENVIRONMENT

Rating		Floor	Wall
6A	Poor	$T \geq 65$	$T \geq 80$
	Fair	$55 \leq T < 65$	$70 \leq T < 80$
	Good	$45 \leq T < 55$	$60 \leq T < 70$
	Best	$T < 45$	$T < 60$
6B	Poor	$T \geq _$	$T \geq _$
	Fair	$_ \leq T < _$	$_ \leq T < _$
	Good	$_ \leq T < _$	$_ \leq T < _$
	Best	$T < _$	$T < _$
Max/Rating		$_ / _$	$_ / _$

HANDLE TEMPERATURE

Rating		Metallic	Nonmetallic
7A	Poor	$T \geq 32$	$T \geq 44$
	Fair	$26 \leq T < 32$	$38 \leq T < 44$
	Good	$20 \leq T < 26$	$32 \leq T < 38$
	Best	$T < 20$	$T < 32$
7B	Poor	$T \geq _$	$T \geq _$
	Fair	$_ \leq T < _$	$_ \leq T < _$
	Good	$_ \leq T < _$	$_ \leq T < _$
	Best	$T < _$	$T < _$
Max/Rating		$_ / _$	$_ / _$

Result 5	
----------	--

Result 6	
----------	--

Result 7	
----------	--

Notes:

8. CHIMNEY SHIELDING

(solar stoves and stoves without chimneys receive Best rating)

Equipment: Fuel, igniter, chalk, ruler / tape measure, hand-held thermocouple

Procedure:

- a) *If the chimney has no protective shielding, surface temperature metrics from Test 5 are used for rating.*
- b) *If the chimney has protective covering, measurements are taken to calculate the average area of gaps, A.*

Rating	Hole size (cm²)
Poor	$A \geq 150$
Fair	$50 \leq A < 150$
Good	$10 \leq A < 50$
Best	$A < 10$

Notes:

Area _____

Result 8	
----------	--

9. FLAMES SURROUNDING COOKPOT

(solar stoves receive Best rating)

Equipment: Cookpot

Procedure:

- a) Keep cookstove fully ablaze from previous tests.
- b) Place cook pot into cooking position.
- c) Observe the amount of uncovered flames surrounding the cookpot and record a description.
- d) Compare description with table to find rating.
- e) Remove cook pot.

Rating	Amount of Uncovered Flames Touching Cookpot
Poor	entire cook pot and/or handles
Fair	most of cook pot, not handles
Good	less than 4 cm up the sides, not handles
Best	none

Description _____

Result 9	
----------	--

Notes:

10. FLAMES EXITING FUEL CHAMBER, CANISTER, OR PIPES

(solar stoves = Best)

Equipment: None

Procedure:

- a) Keep cookstove fully ablaze from previous tests. b) Visually inspect the amount, if any, of flames coming out of the fuel chamber, canister or pipes and record if flames do or do not protrude. c) Consult table to find rating.

Rating	Occurrence of Fire
Poor	Flames protrude
Best	Flames are contained

Result 10	
-----------	--

Description _____

Notes:

Overall Cookstove Safety Rating

To calculate the overall cookstove safety rating, place the point value of each individual rating in the “Value” column. Next multiply the individual ratings by their respective weights and place result in “Total” column. Sum these values and place that number in the box SUM. This value is applied to the overall rating metric to provide the overall safety rating of the stove.

Test	Value
1	_____
2	_____
3	_____
4	_____
5	_____
6	_____
7	_____
8	_____
9	_____
10	_____
SUM	<input style="width: 100px; height: 30px;" type="text"/>

Individual Rating	Value
Best	4
Good	3
Fair	2
Poor	1

Overall Rating	Value
Best	35 - 40
Good	28 - 34
Fair	20 - 27
Poor	10 - 19

Notes:

Overall Rating	<input style="width: 80%; height: 30px;" type="text"/>
-----------------------	--



Aprovecho Research Center
Advanced Studies in Appropriate Technology



SHELL
FOUNDATION



United States
Environmental Protection
Agency

Office of Air & Radiation
EPA 402-K-11-001
November 2011