

T R A N S I T C O O P E R A T I V E R E S E A R C H P R O G R A M

SPONSORED BY

The Federal Transit Administration

TCRP Report 2

Applicability of Low-Floor Light Rail Vehicles in North America

Transportation Research Board
National Research Council

TCRP OVERSIGHT AND PROJECT SELECTION COMMITTEE

CHAIRMAN

WILLIAM W. MILLAR
Port Authority of Allegheny County

MEMBERS

SHARON D. BANKS
AC Transit
LEE BARNES
Barwood, Inc.
GERALD L. BLAIR
Indiana County Transit Authority
MICHAEL BOLTON
Capital Metro
SHIRLEY A. DELIBERO
New Jersey Transit Corporation
ROD DIRIDON
Santa Clara County Transit District
SANDRA DRAGGOO
CATA
LOUIS J. GAMBACCINI
SEPTA
DELON HAMPTON
Delon Hampton & Associates
RICHARD R. KELLY
Port Authority Trans-Hudson Corp.
ALAN F. KIEPPER
New York City Transit Authority
EDWARD N. KRAVITZ
The Fxible Corporation
ROBERT G. LINGWOOD
BC Transit
MIKE MOBEY
Isabella County Transportation Comm.
DON S. MONROE
Pierce Transit
PATRICIA S. NETTLESHIP
The Nettleship Group, Inc.
ROBERT E. PAASWELL
The City College of New York
JAMES P. REICHERT
Transportation Management Services
LAWRENCE G. REUTER
WMATA
MICHAEL S. TOWNES
Peninsula Transportation Dist. Comm.
FRANK J. WILSON
New Jersey DOT

EX OFFICIO MEMBERS

GORDON J. LINTON
FTA
JACK R. GILSTRAP
APTA
RODNEY E. SLATER
FHWA
FRANCIS B. FRANCOIS
AASHTO
ROBERT E. SKINNER, JR.
TRB

TDC EXECUTIVE DIRECTOR

FRANK J. CIHAK
APTA

SECRETARY

ROBERT J. REILLY
TRB

TRANSPORTATION RESEARCH BOARD EXECUTIVE COMMITTEE 1995

OFFICERS

Chair: *Lillian C. Borrone, Director, Port Authority, The Port Authority of New York and New Jersey*
Vice Chair: *James W. VAN Loben Sels, Director, California Department of Transportation*
Executive Director: *Robert E. Skinner, Jr., Transportation Research Board*

MEMBERS

EDWARD H. ARNOLD, *Chair and President, Arnold Industries, Lebanon, PA*
SHARON D. BANKS, *General Manager, AC Transit, Oakland, CA*
BRIAN J.L. BERRY, *Lloyd Viel Berkner Regental Professor & Chair, Bruton Center for Development Studies, University of Texas at Dallas*
DWIGHT M. BOWER, *Director, Idaho Department of Transportation*
JOHN E. BREEN, *The Nasser I. Al-Rashid Chair in Civil Engineering, The University of Texas at Austin*
DAVID BURWELL, *President, Rails-to-Trails Conservancy, Washington, DC*
A. RAY CHAMBERLAIN, *Vice President, Freight Policy, American Trucking Associations, Inc., Alexandria, VA (Past Chair, 1993)*
RAY W. CLOUGH, *Nishkian Professor of Structural Engineering, Emeritus, University of California, Berkeley*
JAMES N. DENN, *Commissioner, Minnesota Department of Transportation*
JAMES C. DELONG, *Director of Aviation, Denver International Airport, Denver, CO*
DENNIS J. FITZGERALD, *Executive Director, Capital District Transportation Authority, Albany, NY*
JAMES A. HAGEN, *Chairman of the Board, Conrail Inc., Philadelphia, PA*
DELON HAMPTON, *Chairman & CEO, Delon Hampton & Associates, Washington, DC*
LESTER A. HOEL, *Hamilton Professor, Civil Engineering, University of Virginia*
DON C. KELLY, *Secretary, Kentucky Transportation Cabinet*
ROBERT KOCHANOWSKI, *Executive Director, Southwestern Pennsylvania Regional Planning Commission*
JAMES L. LAMMIE, *President & CEO, Parsons Brinckerhoff, Inc., New York, NY*
CHARLES P. O'LEARY, JR., *Commissioner, New Hampshire Department of Transportation*
JUDE W. P. PATIN, *Secretary, Louisiana Department of Transportation and Development*
CRAIG E. PHILIP, *President, Ingram Barge Co., Nashville, TN*
DARREL RENSINK, *Director, Iowa Department of Transportation*
JOSEPH M. SUSSMAN, JR *East Professor, Civil and Environmental Engineering, MIT*
MARTIN WACHS, *Director, Institute of Transportation Studies, University of California, Los Angeles*
DAVID N. WORMLEY, *Dean of Engineering, Pennsylvania State University*
HOWARD YERUSALIM, *Secretary of Transportation, Pennsylvania Department of Transportation*

EX OFFICIO MEMBERS

MIKE ACOTT, *President, National Asphalt Pavement Association*
ROY A. ALLEN, *Vice President, Research and Test Department, Association of American Railroads*
ANDREW H. CARD, JR., *President and CEO, American Automobile Manufacturers Association*
THOMAS J. DONOHUE, *President and CEO, American Trucking Associations*
FRANCIS B. FRANCOIS, *Executive Director, American Association of State Highway and Transportation Officials*
JACK R. GILSTRAP, *Executive Vice President, American Public Transit Association*
ALBERT J. HERBERGER, *Maritime Administrator, U.S. Department of Transportation*
DAVID R. HINSON, *Federal Aviation Administrator, U.S. Department of Transportation*
GORDON J. LINTON, *Federal Transit Administrator, U.S. Department of Transportation*
RICARDO MARTINEZ, *Federal Railroad Administrator, U.S. Department of Transportation*
JOLENE M. MOLITORIS, *Federal Railroad Administrator, U.S. Department of Transportation*
DAVE SHARMA, *Research and Special Programs Administrator, U.S. Department of Transportation*
RODNEY E. SLATER, *Federal Highway Administrator, U.S. Department of Transportation*
HOWARD M. SMOLKIN, *National Highway Traffic Safety Administrator, U.S. Department of Transportation*
ARTHUR E. WILLIAMS, *Chief of Engineers and Commander, U.S. Army Corps of Engineers*

TRANSIT COOPERATIVE RESEARCH PROGRAM

Transportation Research Board Executive Committee Subcommittee for TCRP
LILLIAN C. BORRONE, *The Port Authority of New York and New Jersey (Chair)*
SHARON D. BANKS, *AC Transit*
LESTER A. HOEL, *University of Virginia*
GORDON J. LINTON, *U.S. Department of Transportation*
ROBERT E. SKINNER, JR., *Transportation Research Board*
JOSEPH M. SUSSMAN, *Massachusetts Institute of Technology*
JAMES W. VAN LOBEN SELS, *California Department of Transportation*

Report 2

Applicability of Low-Floor Light Rail Vehicles in North America

BOOZ • ALLEN & HAMILTON INC.
McLean, VA

Subject Area

Public Transit

Research Sponsored by the Federal Transit Administration in
Cooperation with the Transit Development Corporation

TRANSPORTATION RESEARCH BOARD
NATIONAL RESEARCH COUNCIL

NATIONAL ACADEMY PRESS
Washington, D.C. 1995

TRANSIT COOPERATIVE RESEARCH PROGRAM

The nation's growth and the need to meet mobility, environmental, and energy objectives place demands on public transit systems. Current systems, some of which are old and in need of upgrading, must expand service area, increase service frequency, and improve efficiency to serve these demands. Research is necessary to solve operating problems, to adapt appropriate new technologies from other industries, and to introduce innovations into the transit industry. The Transit Cooperative Research Program (TCRP) serves as one of the principal means by which the transit industry can develop innovative near-term solutions to meet demands placed on it.

The need for TCRP was originally identified in *TRB Special Report 213—Research for Public Transit: New Directions*, published in 1987 and based on a study sponsored by the Urban Mass Transportation Administration—now the Federal Transit Administration (FTA). A report by the American Public Transit Association (APTA), *Transportation 2000*, also recognized the need for local, problem-solving research. TCRP, modeled after the longstanding and successful National Cooperative Highway Research Program, undertakes research and other technical activities in response to the needs of transit service providers. The scope of TCRP includes a variety of transit research fields including planning, service configuration, equipment, facilities, operations, human resources, maintenance, policy, and administrative practices.

TCRP was established under FTA sponsorship in July 1992. Proposed by the U.S. Department of Transportation, TCRP was authorized as part of the Intermodal Surface Transportation Efficiency Act of 1991 (ISTEA). On May 13, 1992, a memorandum agreement outlining TCRP operating procedures was executed by the three cooperating organizations: FTA, the National Academy of Sciences, acting through the Transportation Research Board (TRB), and the Transit Development Corporation, Inc. (TDC), a nonprofit educational and research organization established by APTA. TDC is responsible for forming the independent governing board, designated as the TCRP Oversight and Project Selection (TOPS) Committee.

Research problem statements for TCRP are solicited periodically but may be submitted to TRB by anyone at any time. It is the responsibility of the TOPS Committee to formulate the research program by identifying the highest priority projects. As part of the evaluation, the TOPS Committee defines funding levels and expected products.

Once selected, each project is assigned to an expert panel, appointed by the Transportation Research Board. The panels prepare project statements (requests for proposals), select contractors, and provide technical guidance and counsel throughout the life of the project. The process for developing research problem statements and selecting research agencies has been used by TRB in managing cooperative research programs since 1962. As in other TRB activities, TCRP project panels serve voluntarily without compensation.

Because research cannot have the desired impact if products fail to reach the intended audience, special emphasis is placed on disseminating TCRP results to the intended endusers of the research: transit agencies, service providers, and suppliers. TRB provides a series of research reports, syntheses of transit practice, and other supporting material developed by TCRP research. APTA will arrange for workshops, training aids, field visits, and other activities to ensure that results are implemented by urban and rural transit industry practitioners.

The TCRP provides a forum where transit agencies can cooperatively address common operational problems. The TCRP results support and complement other ongoing transit research and training programs.

TCRP REPORT 2

Project C-2 FY '92
ISSN 1073-4872
ISBN 0-309-05373-0
Library of Congress Catalog Card No. 95-60975

Price \$31.00

NOTICE

The project that is the subject of this report was a part of the Transit Cooperative Research Program conducted by the Transportation Research Board with the approval of the Governing Board of the National Research Council. Such approval reflects the Governing Board's judgment that the project concerned is appropriate with respect to both the purposes and resources of the National Research Council.

The members of the technical advisory panel selected to monitor this project and to review this report were chosen for recognized scholarly competence and with due consideration for the balance of disciplines appropriate to the project. The opinions and conclusions expressed or implied are those of the research agency that performed the research, and while they have been accepted as appropriate by the technical panel, they are not necessarily those of the Transportation Research Board, the Transit Development Corporation, the National Research Council, or the Federal Transit Administration of the U.S. Department of Transportation.

Each report is reviewed and accepted for publication by the technical panel according to procedures established and monitored by the Transportation Research Board Executive Committee and the Governing Board of the National Research Council.

Special Notice

The Transportation Research Board, the Transit Development Corporation, the National Research Council, and the Federal Transit Administration (sponsor of the Transit Cooperative Research Program) do not endorse products or manufacturers. Trade or manufacturers' names appear herein solely because they are considered essential to the clarity and completeness of the project reporting.

Published reports of the

TRANSIT COOPERATIVE RESEARCH PROGRAM

are available from:

Transportation Research Board
National Research Council
2101 Constitution Avenue, N.W.
Washington, D.C. 20418

Printed in the United States of America

FOREWORD

*By Staff
Transportation Research
Board*

This report will be of interest to transit managers, engineers, and policy makers considering the introduction of low-floor light rail vehicles in existing or planned light rail systems. The report investigates the state of the art of low-floor light rail vehicles and assesses the applicability of their use in North America. Low-floor light rail vehicle categories have been developed to facilitate the understanding of the different types of vehicles and their applications. The report describes the growing trend toward low-floor light rail vehicles and the reasons for this growth. It provides an extensive compilation of data on low-floor light rail vehicles, information on North American light rail system characteristics, and an analytical perspective on key issues relevant to the applicability of this technology in North America. The report also develops example applications to demonstrate the cost-effectiveness of using low-floor light rail vehicles, the source of risk, and the trade-offs regarding the use of low-floor versus high-floor light rail vehicles.

In Europe, significant progress is being made on the development and deployment of low-floor light rail vehicles. Interest in low-floor light rail vehicles in the United States began in the 1960s but gained support more recently because of the need to be responsive to regulations implementing the Americans with Disabilities Act (ADA). Moreover, transit operators have come to recognize that improved system-performance benefits can potentially be achieved under certain conditions by using low-floor design concepts. For example, reduced boarding times mean faster service and shorter trip times for all passengers. This enables transit operators to use equipment more efficiently, thereby potentially reducing operating, maintenance, and capital costs.

Under TCRP Project C-2, research was undertaken by Booz • Allen & Hamilton, Inc. to assess the potential applicability of low-floor light rail vehicle technology in North America.

To achieve the project objectives, a comprehensive review of existing information on the state of the art in low-floor light rail vehicles was conducted. As part of this process, transit agencies using and considering low-floor light rail vehicles and the suppliers of these vehicles were contacted to obtain information and operating experience on vehicles both in revenue service and in research and development. The research focused heavily on current European experience with low-floor light rail vehicle technology. Upon collecting this information, a framework for assessing the application of low-floor light rail vehicles in North America was developed focusing on the critical factors that should be considered. Thus, the report is a valuable resource for transit professionals considering the use of low-floor light rail vehicles in existing or planned light rail systems.

Material from this report was considered by the Santa Clara County Transportation Agency (SCCTA) in conjunction with its 1994 assessment of the technological risk of low-floor light rail vehicles. The relatively low risk of Category-2 low-floor light rail vehicles coupled with developments in ADA compliance and noncost issues resulted in a decision to plan for low-floor light rail vehicles as the fleet of the future for the SCCTA.

CONTENTS

1	SUMMARY
2	CHAPTER 1 Introduction
	Background and Research Objectives, 2
	Attributes and Distinguishing Features of LF-LRVs, 5
	LF-LRV Development History, 7
	LF-LRV Market Statistics, 9
	Organization of Report, 10
13	CHAPTER 2 State-of-the-Art Review
	Classification System, 13
	Characteristics Compendium, 13
	Detailed Description of LF-LRVs, 13
	New Technology Description and Assessment, 29
	Maintenance Experience with LF-LRVs, 43
	Published and Reported Prices, 45
47	CHAPTER 3 Application Considerations
	Dimensional Compatibility, 47
	Operating Issues, 50
	Compliance with North American Specifications, 53
55	CHAPTER 4 North American Light Rail Transit Systems Characteristics
	Platform Characteristics, 55
	Right-of-Way Characteristics, 56
	System Characteristics, 57
	Operations Characteristics, 57
	Vehicle Characteristics, 59
60	CHAPTER 5 Applicability Framework Assessment Model
	Define Available Options, 60
	Assess Technological Risk, 61
	Evaluate Physical Compatibility, 62
	Quantify Operational Impacts, 63
	Evaluate Costs and Benefits, 65
	Evaluate Noncost Issues, 66
	Select the Best Option, 66
67	CHAPTER 6 Case Studies
	Case Study 1, 67
	Options Available for Consideration, 67
	Technological Risk Assessment, 68
	Physical Compatibility Evaluation, 68
	Operational Impact Quantification, 70
	Cost Estimation, 70
	Noncost Issues, 70
	The Next Steps, 72
	Case Study 2, 72
	Options Available for Consideration, 72
	Technological Risk Assessment, 72
	Physical Compatibility Evaluation, 73
	Operational Impact Quantification, 73
	Cost Estimation, 75
	Noncost Issues, 75
	The Next Steps, 76
77	CHAPTER 7 Conclusions
	Introduction, 77
	Classification of LF-LRVs, 77
	Comparison of Conventional and LF-LRVs, 77
	Applicability of LF-LRVs in North America, 78
	Suggested Research, 78
80	REFERENCES
81	APPENDIX A LF-LRV Database
160	APPENDIX B North American LRT Systems Database
169	APPENDIX C Glossary
170	APPENDIX D Bibliography

COOPERATIVE RESEARCH PROGRAMS STAFF

ROBERT J. REILLY, *Director, Cooperative Research Programs*

STEPHEN J. ANDRLE, *Manager, Transit Cooperative Research Program*

CHRISTOPHER W. JENKS, *Senior Program Officer*

EILEEN P. DELANEY, *Editor*

KAMI CABRAL, *Senior Editorial Assistant*

PROJECT PANEL C-2

DENNIS L. PORTER, *TRI-MET, Portland, OR (Chair)*

JOHN J. BAKKER, *St. Albert, Alberta*

FRANK CIHAK, *APTA, Washington, DC*

ROD DIRIDON, *IISTPS, San Jose State University, San Jose, CA*

HAROLD S. EDRIS, JR., *MTA, Baltimore, MD*

BOUDEWYN KLUGE, *MBTA, Boston, MA*

THOMAS J. MCGEAN, *Annandale, VA*

JEFFREY MORA, *FTA Liaison Representative*

PETER SHAW, *TRB Liaison Representative*

ACKNOWLEDGMENTS

James R. Zearth of Booz • Allen & Hamilton Inc. was the Principal Investigator for the report. Valuable assistance was provided by R. Alex Curmi, Stelian "Stan" Canjea, Matthew W. Pollack, Yonel Grant, and Sue Mason of Booz • Allen & Hamilton; and Joachim von Rohr and Thomas Kuchler of Light Rail Transit Consultants GmbH in the collection of data and preparation of the report.

Valuable assistance in reviewing the progress and quality of the report was provided by the TCRP Project Panel C-2 listed above.

The TCRP Senior Program Officer responsible for report preparation was Christopher W. Jenks. His help and guidance were invaluable.

Information on vehicles, system characteristics, and current practices was provided by many transit agencies and manufacturers. Their cooperation and assistance were most helpful and greatly appreciated.

APPLICABILITY OF LOW-FLOOR LIGHT RAIL VEHICLES IN NORTH AMERICA

SUMMARY

There is a dramatic trend to the increased use of low-floor light rail vehicles (LF-LRVs) in Europe. The study investigates state-of-the-art low-floor vehicle development and assesses the applicability of LF-LRVs for use in North America.

For the purposes of describing LF-LRVs in this report, a classification system has been developed that splits all LF-LRVs into one of three categories. The classification system used is based primarily on type of running gear. This system was selected because the proposed categories represent increasing application complexity and change, the three categories correspond to the proportion of low-floor area, and the three categories represent increasing levels of technological innovation. The categories are described as follows:

- **Category-1** vehicles use conventional motor and trailer trucks throughout and generally have 9 to 15 percent low-floor area but may have up to 48 percent low-floor area.
- **Category-2** vehicles use conventional motor trucks at each end and innovative trailer trucks in between them, with generally 50 percent to 75 percent uninterrupted low-floor area between the motor trucks.
- **Category-3** vehicles use innovative motored and trailing running gear throughout to provide 100 percent low-floor areas.

While there have been a substantial number of Category-1 and Category-2 orders in the past, the trend in Europe is toward refinement and implementation of Category-3 vehicles.

An Applicability Framework Assessment Model has been developed to assist in the evaluation of LF-LRV applicability. LF-LRVs offer a number of possible advantages over conventional vehicles. Platforms to allow level boarding of LF-LRVs can be much smaller in scale and less expensive than corresponding platforms for high-floor systems. Therefore, it is more likely that level boarding can be implemented. Improved vehicle accessibility and faster boarding can result in reduced round-trip times and savings in fleet requirements in some cases. As a result, LF-LRVs provide a more economical transportation solution than conventional LRVs in some circumstances. Even where cost savings do not accrue, the improved accessibility provided by LF-LRVs can be a powerful incentive to the selection of a LF-LRV solution. The Applicability Framework Assessment Model presented in this report provides a mechanism to assess analytically the cost-effectiveness of using LF-LRVs, the sources of risk, and the trade-offs regarding the use of low-floor versus high-floor light rail vehicles. Specific applicability will depend on the results produced by exercising this model for the proposed application.

CHAPTER 1

INTRODUCTION

BACKGROUND AND RESEARCH OBJECTIVES

This report documents research undertaken through the Transit Cooperative Research Program to examine the applicability of low-floor light rail vehicles (LF-LRVs) to North American light rail transit (LRT) systems and thereby analyze the perceived advantages and other key applicability issues. The research problem statement required compilation of existing information on LF-LRVs, including engineering, operating, maintenance, economic, and institutional factors that are relevant to running LF-LRVs on existing and planned LRT systems in North America. The research findings were intended to serve transportation professionals and policy makers.

After submittal of an interim report and discussions by the project advisory panel, the following were defined as the specific outputs and results sought from the research:

- A comprehensive review of existing information on the state of the art and operating experience;
- Development of a generic classification system for LF-LRVs;
- Compilation of a vehicle characteristics database;
- Identification of the critical factors that should be considered in evaluating applicability;
- A generic grouping of North American LRT systems, in relation to the identified evaluation factors;
- A framework for assessing the application of a generic class of LF-LRV in a generic LRT system group; and
- Use of the framework in two case studies.

Advent of LF-LRVs

During the last 10 years, LF-LRVs have been put into service at several major transit systems. Although some early examples appeared as far back as 1925 (shown in Figures 1 and 2), the first modern vehicle—now commonly accepted as a low-floor tram¹—was put into service in Geneva in 1984. The vehicle, developed by Duewag and ACM Vevey, provided approximately 60 percent of the floor area at a height of 480 mm (19 in) above the top of rail (TOR).⁽¹⁾

Prior to 1984, light rail vehicles (LRVs) evolved steadily, and, while there are many variations in the design and configuration of these conventional LRVs, they are usually supported on four-wheel swiveling trucks that sweep a considerable area below the underframe when the vehicles go around horizontal turns. Conventional LRVs have both motored and trailer trucks equipped with flanged wheels that

have a tread diameter range between 560 mm (22 in) and 710 mm (28 in). Therefore, conventional LRVs usually have floors at one level, which must be at a sufficient height to clear the truck under the most adverse suspension deflections. Consequently the floor height range is between 830 mm (32.7 in) and 1,050 mm (41.3 in) above TOR.

Although the conventional LRV design has been optimized in many ways, it has retained a significant disadvantage when passengers must board from low platforms or from street level. In these situations, passengers must climb steps to reach the floor. This makes access difficult for the elderly and practically impossible for persons in wheelchairs. Transit operators recognized several reasons for demanding vehicles with a floor at, or only slightly above, the street curb or low-platform level. Some of the reasons included recognition that climbing steps increases station dwell time, especially if a wheelchair lift is used to circumvent the steps, and access would be easier for the elderly and other mobility-impaired individuals. In the United States, the passage of the Americans with Disabilities Act



Figure 1. Early example of a LF-LRV—1925 vintage car.



Figure 2. Early example of a low-floor trailer from the 1920s—built by Allan for Amsterdam.

¹The term "tram" is the European equivalent of "streetcar" in North America.

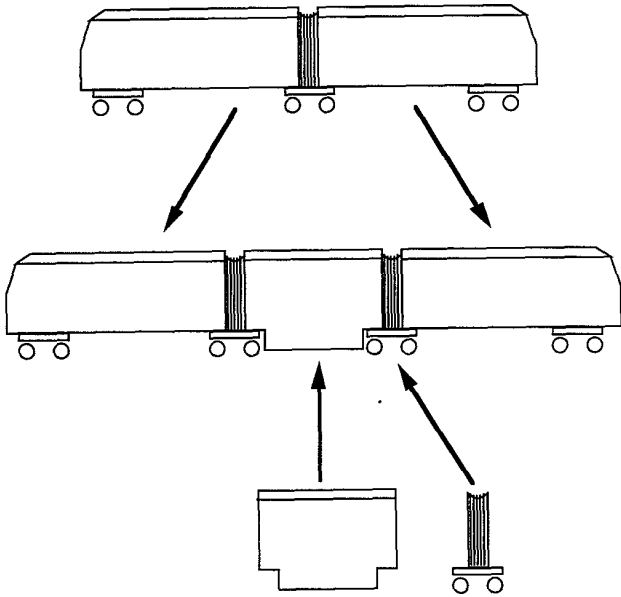


Figure 3. LF-LRV concept—achieved by converting a conventional six-axle, single articulation LRV into an eight-axle, double articulation vehicle.

(ADA) prompted transit operators to look more closely at what European transit systems were using.

The simplest way to create an LRV with a low-floor section is to convert a conventional six-axle, single articulation LRV into an eight-axle, double articulation vehicle. The conversion involves the addition of a fourth truck, a second articulation, and a center-body section. The conversion (Figure 3) provides a low-floor car section in the center of the car with a low-level entrance on one or both sides. An example is a vehicle produced for Amsterdam

(Figure 4). While it provides an economical solution, it does have some drawbacks. The low-floor area is small and interior steps are required in the aisles between the low and high floors. Another variation appeared (Figure 5) that provides low-floor space in the end carbody sections but high-floor areas above the standard trucks. This required a shift of equipment from under the car to above the car.

The popularity of LF-LRVs increased substantially when the Grenoble car was introduced into revenue service in 1987 (Figure 6). It has conventional design motor trucks at the ends, requiring a high floor above them. The center section is supported by a single-trailer truck with independently rotating wheels joined by a cranked axle. Although the wheels are normal size, the gangway drops between them (Figure 7), thereby providing a continuous 18-m (59-ft) low floor that is 65 percent of the total passenger area. Floor height is only 345 mm (13.6 in) above TOR, which has become the standard to surpass.

There has been significant growth in the number and design variations of LF-LRVs since 1987. This growth occurred because of a combination of the following factors:

- A strong demand for new vehicles by several European transit agencies—by the end of the 1980s, several LRV fleets were due for replacement;
- The perceived advantages of LF-LRVs; and
- Manufacturers vying to use more ingenious methods to increase the low-floor area and taking advantage of high technology equipment.

By mid-1994, European LRT operators had placed orders for 1,876 LF-LRVs (including 30 trailers) with low-floor heights ranging from 197 mm (7.8 in) to 530 mm (20.9 in) above TOR. Between 1983 and 1993, approximately 600 conventional high-floor LRVs were ordered.

Every major European car builder (and almost every minor car builder) has manufactured at least one type of low-floor

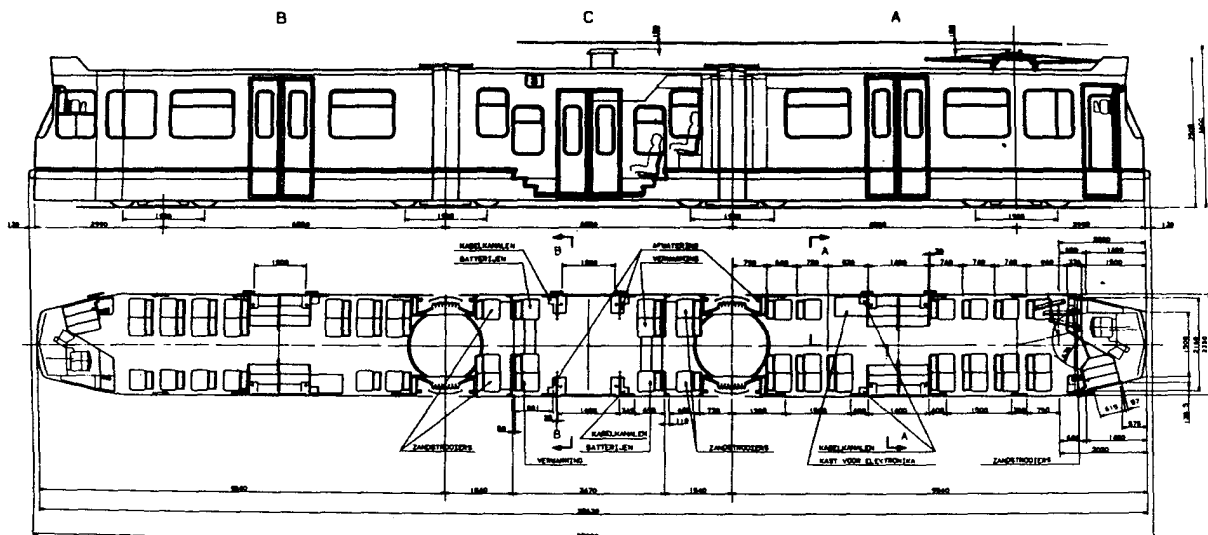


Figure 4. LF-LRV produced for Amsterdam.

vehicle design. Some of these are so revolutionary that they would have been unthinkable in the early 1980s. No single design concept has emerged as distinctly superior, and development of more variants has not yet abated.

The North American debut of LF-LRVs is scheduled for September 1995. The Tri-County Metropolitan Transportation District of Oregon (TRI-MET) in Portland, Oregon, expects delivery of a pilot vehicle that was ordered from Siemens-Duewag Corporation in May 1993. The pilot vehicle will be used for operational and compatibility testing, and the remaining 45 vehicles will be delivered beginning in early 1996.

At the time this report was prepared, several other cities were also considering LF-LRVs. The City of Chicago's Central Area Circulator Project had received seven proposals in response to its Request For Proposal (RFP) for 38 vehicles. The Central Area Circulator Project RFP specified vehicles with 70 percent or more low floor; and a contract award is anticipated in mid-1995. In addition, the Massachusetts Bay Transportation Authority (MBTA) in Boston, Massachusetts, was expecting responses to its RFP for 100 LF-LRVs. The Toronto Transit Commission (TTC) in Toronto, Ontario, has developed specifications and is ready to issue an RFP to procure similar vehicles.

Perceived Advantages of LF-LRVs

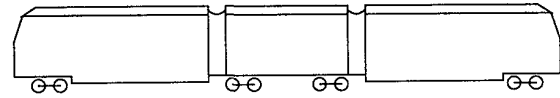
Low-floor vehicles bring a number of benefits to LRT systems with low-platform or street-level boarding(2):

- Accessible and comfortable transportation for all passengers, especially persons using wheelchairs or other mobility devices;
- Easier access for the elderly who previously had difficulty boarding conventional trams(3);
- Popularity among other passengers (especially those pushing strollers or carrying heavy shopping bags);
- Reduced station dwell times, which is especially useful on lines with close station spacing (Tests in Rotterdam, using the Grenoble LF-LRV, demonstrated a 10 percent reduction in round-trip time [2]); and
- Increased patronage (resulting from the previously listed advantages) and greater productivity.

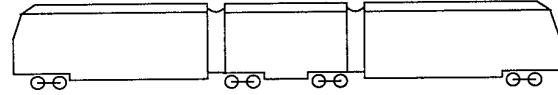
Notice that the advantages are the same as those that are already inherent in existing LRT systems that exclusively have high-platform stations.

Key Applicability Issues

U.S. transit operators are also interested in LF-LRVs as a means of complying with the ADA, which requires at least one vehicle in every train to be accessible to persons with disabilities, beginning in 1995. However, several questions



The Sheffield configuration has low floors in the outer sections



The Freiburg configuration has a low floor in the center section as well as in the outer sections

Figure 5. LF-LRV variations—Sheffield and Freiburg configurations.



Figure 6. Grenoble LF-LRV.

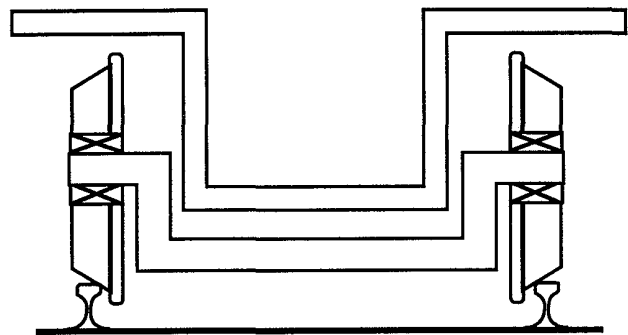


Figure 7. Cutaway view of Grenoble LF-LRV center section.

arise in evaluating the application of existing European LF-LRVs in North American service:

- Is there a price premium for LF-LRVs, and if so, what is it?

- What are the maintenance implications (resulting from increased complexity and departure from proven and familiar technology)?
- Are the presumed higher life-cycle costs offset by the increased productivity (as is generally perceived to be true in Europe)?
- Is a particular LF-LRV physically compatible with the transit system's current vehicles, infrastructure, and other subsystems? For example, can the LF-LRVs couple with existing cars (that may have considerable operating life remaining)?
- Are the currently available LF-LRVs, which are predominantly European, capable of meeting North American safety standards and the usually more stringent design criteria without costly redesign?
- Do the performance capabilities of LF-LRVs match requirements of the exclusive right-of-way routes frequently found in North American LRT systems?

In addition, several specific technical issues will need to be considered by North American transit operators before selecting a LF-LRV. For example, is the use of the following components acceptable:

- Small wheels?—The technical issue is limited wear life and increased contact stress.
- Unsprung motors and gearboxes?—The technical issue is the high shocks they experience and generate.

Applicability and technical issues are addressed in detail in Chapter 3.

ATTRIBUTES AND DISTINGUISHING FEATURES OF LF-LRVs

As the name implies, LF-LRVs have some portion of the floor at a significantly lower level than conventional LRVs.

In practice, the low-floor area can extend from 9 percent to 100 percent of the car length. LF-LRVs have evolved substantially over the past 10 years. Many of the newer vehicles provide an increased proportion of low-floor area than their predecessors, which is why it has become customary to refer to LF-LRVs by the percentage of low-floor area.

For the purposes of describing LF-LRVs in this report, a classification system has been developed that splits all LF-LRVs into one of three categories—Category 1 with all conventional trucks; Category 2 with conventional motor trucks; and Category 3 with innovative motor and running gear throughout. The categories are described below and explored in more detail in Chapter 2.

LF-LRVs with All Conventional Trucks (Category-1 LF-LRVs)

LF-LRVs with all conventional trucks usually have a 9 percent to 15 percent low-floor area in a center section inserted between two articulation joints, each of which is supported by a truck (Figure 8). A variation from this basic concept is the addition of a low floor in the outer carbody sections (Figure 5), providing a 34 percent low floor in the Sheffield configuration, or in all three carbody sections, achieving a 48 percent low floor in the Duewag GT8D built for Freiburg. The last two examples feature "floating" articulations that are not directly supported by a truck.

The low-floor height ranges from 270 mm (10.6 in) to 480 mm (18.9 in); the high-floor height range is 560 mm (22 in) to 910 mm (35.8 in). A step or slope is required between the two levels.

As the percentage of low-floor area increases, it becomes necessary to shift equipment (usually mounted below the underframe) to above the roof or within the vehicle body. Because the underframes are discontinuous, the buff load path is less direct and somewhat more difficult to distribute.

An important innovation on some LF-LRVs with all conven-

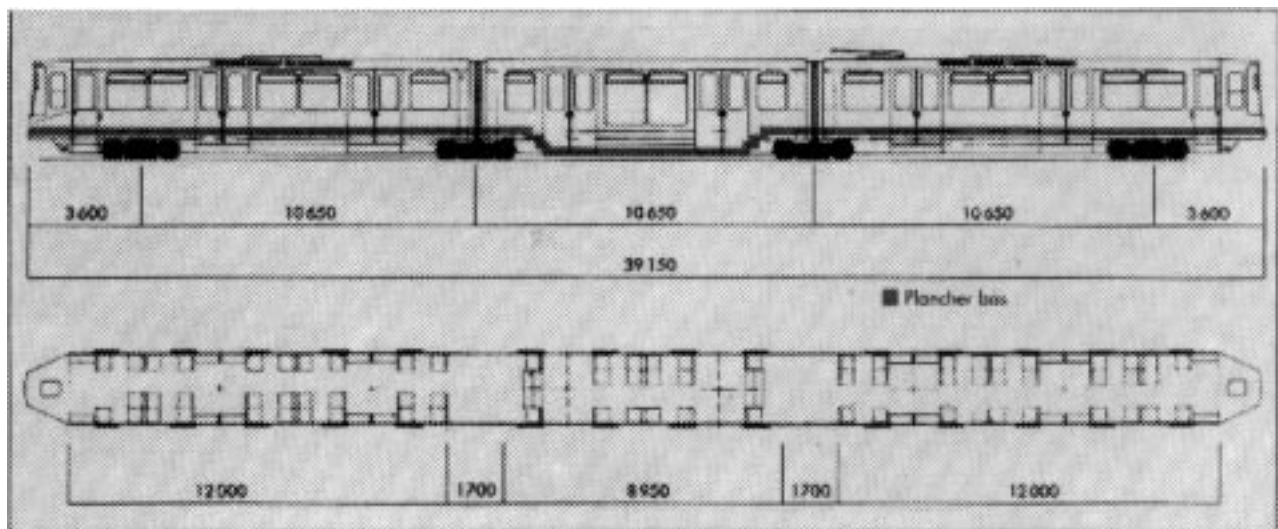


Figure 8. Category-1 LF-LRV—side- and top-view schematic.

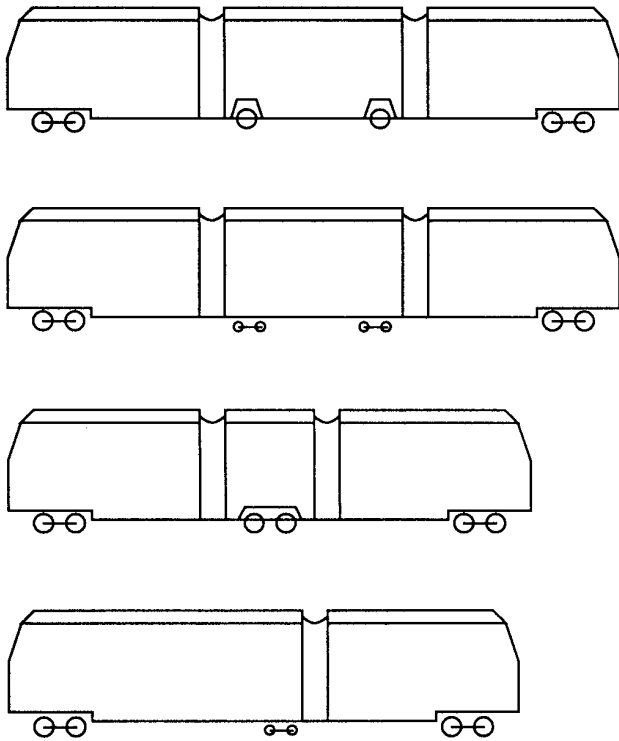
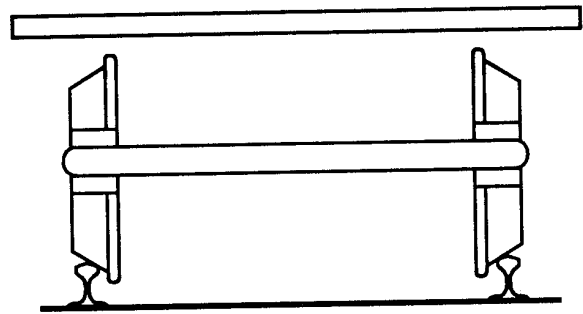


Figure 9. Various configurations of Category-2 LF-LRVs with conventional motor trucks.

tional trucks was the introduction of "floating" articulations. A floating articulation is one that is not directly supported by a truck. In all other ways, vehicles that make use of floating articulations are a close derivative of the conventional, double-articulated, eight-axle trams—such as the Duewag N8 and M8 families. These vehicles are supported by conventional monomotor or bimotor power trucks and ordinary trailer trucks with slew ring center bearings, two-stage suspensions, and two conventional wheel-axle assemblies that use normal size wheels with diameters of 590 mm (23.2 in) to 690 mm (27.2 in). All four trucks can be powered to provide 100 percent adhesion and high acceleration, but because they are normally used on street lines, maximum speed is usually between 70 and 80 km/h (44 to 50 mph).

LF-LRVs with Conventional Motor Trucks (Category-2 LF-LRVs)

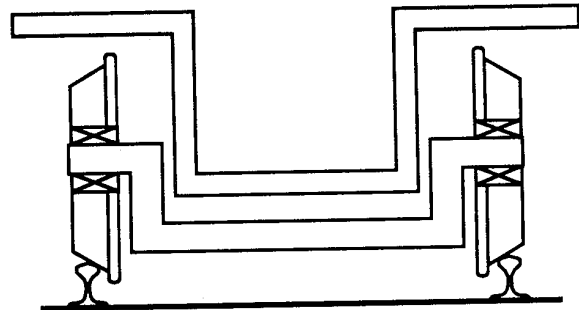
LF-LRVs with conventional motor trucks (Category-2 LF-LRVs) retain the use of conventional power trucks at either end (Figure 9), but feature a continuous low floor between the trucks (between 50% and 73%). This precludes the use of conventional trucks in the center of the vehicle. Instead, the continuous low-floor gangway is achieved with innovative trailer trucks. Trailer trucks may use either small wheels with



Single Axle Conventional Wheelset



Small Diameter Wheels



Independently Rotating Wheels—Cranked Axle

Figure 10. Cutaway view of trailer truck configurations for Category-2 LF-LRVs.

diameters between 375 mm and 410 mm (14.8 in and 16.1 in) or independently rotating wheels of normal size (Figure 10).

When small wheels are used, they are connected by a rigid axle and have profiled treads, thus retaining the conventional self-centering wheelset principle. Wheel diameters may be small enough for the top of the axles to allow the floor to be

lowered to 300 mm (11.8 in) above TOR over the axles. However, 350 mm (13.8 in) to 480 mm (18.9 in) above TOR is more typical. The small wheelsets are connected in pairs by a compact truck frame. Vehicles can have either one or two center trucks and either standard or floating articulations.

In cases where independently rotating wheels are used, they are mounted in pairs (transversely connected by a cranked axle), on special truck frames with very low cross transoms, or on small "single-axle" or wheelset truck frames. The independent wheels may be unsteered, self-steered, or force steered, as described in Chapter 2.

The confined space below the low floor requires the use of compact equipment; therefore, hydraulically actuated calipers and discs are generally used for braking.

Central running gear wheels in Category-2 vehicles are not powered. Maximum speeds typically range between 60 and 70 km/h (38 to 40 mph). However, when TRI-MET (Portland) specified that its LF-LRVs should have comparable performance to its existing conventional LRVs, the evaluation indicated that Siemens-Duewag Corporation could comply with the specified higher speed of 90 km/h (55 mph).

LF-LRVs with Innovative Motor and Running Gear (Category-3 LF-LRVs)

The newest type of LF-LRVs (Category 3) features the following common attributes (typical configurations are shown in Figure 11):

- 100 percent low floor;
- Floor heights less than or equal to 360 mm (14.2 in), the lowest being 197 mm (7.8 in), and with entrance thresholds as low as 152 mm (6 in);
- Novel and sometimes revolutionary running gear;
- State-of-the-art propulsion equipment—in some cases using motors mounted directly on, or forming, the wheel hubs;
- Independently rotating wheels, either driven or free wheeling, usually with some form of steering; and
- No underframe-mounted equipment, except running gear or motors.

The running gear designs vary radically from vehicle to vehicle, and none has emerged as superior. These vehicles have little in common with conventional LRVs. Indeed, being state-of-the-art vehicles, they embody several innovations, including flexible modular designs, use of lightweight materials, bolted construction, and modern streamlining.

Category-3 LF-LRVs provide maximum utility because floors are low throughout their length, thereby avoiding internal stairs and allowing low-level boarding from every doorway. This makes for more efficient on-board fare collection, which has been cited as one of the motivations for developing them.

LF-LRV DEVELOPMENT HISTORY

The development of Category-1 and Category-2 LF-LRVs, during the early and mid 1980s respectively, was driven by

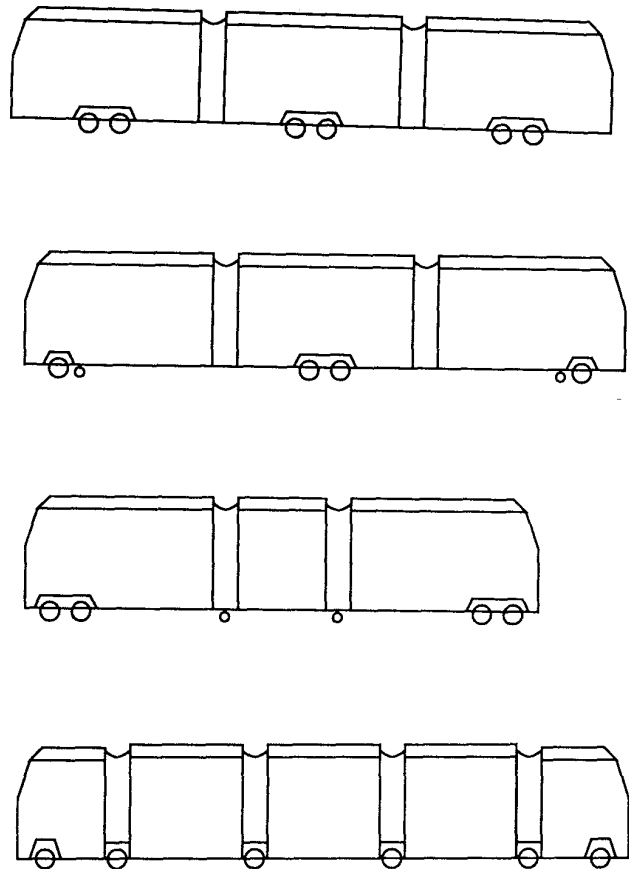


Figure 11. Typical configurations of Category-3 LF-LRVs.

social and political pressures to provide improved access to transportation systems. Most of the LF-LRV concepts developed during the early-to-mid 1980s had the following common disadvantages:

- There were steps or ramps between the low- and high-floor areas.
- A low platform was needed at approximately the same level as the low floor, which cannot be provided on some city street routes.
- The driver's cab must be located in a high-floor area. Therefore, LRT systems that use on-board fare collection adjacent to the operator must use vehicles with steps that passengers must climb in order to pass the farebox and driver.

Recognizing these shortcomings and wanting to give its domestic manufacturers a competitive edge, the German Association of Public Transport Operations, VDV (formerly VÖV), decided that a new standard tram with a low floor throughout its length was needed. In 1986, VDV set up a consortium of German suppliers and three transit operators to develop the most radical streetcar design since the PCC car. The DM 45 million "Stadtbahn 2000" project was partially funded by the

TABLE 1 Stadtbahn 2000 project prototype characteristics

Characteristics	Prototype I	Prototype II	Prototype III
Gauge	1,435 mm	1,435 mm	1,000 mm
Wheel Arrangement*	A'A'1	A'A'1	A'A'A'1
Number of Wheels/Car	6	6	8
Carbody Material	Steel	Aluminum	Steel
Carbody Length/Width	20 19/2 4 m	20 19/2 4 m	26 69/2 3 m
Seat Arrangement	2+1 transverse	2+2 transverse	2+1 transverse
Wheel Diameter	560 mm	560 mm	560 mm
Maximum Vehicle Speed	70 km/h	70 km/h	80 km/h
Vehicle Mass (empty)	17,750 kg	18,560 kg	23,980 kg
Specific Mass (kg/sq m)	366	383	391
Floor Height (from TOR to door/passenger areas)	290/350 mm	290/350 mm	290/350 mm
Originally Proposed Test Locations	Dusseldorf	Bonn	Mannheim

* See the Glossary for descriptions of wheel arrangements.

German Federal Ministry of Research and Technology. Some of the Stadtbahn 2000 objectives were to

- Develop a new standard tram with a 100 percent low floor;
- Minimize specific mass (i.e., mass floor area) and therefore energy consumption;
- Reduce the number of wheels and drives to lower both mass and price;
- Exploit the self-steering, independently rotating wheel, Einzelrad-Einzel-Fahrwerk (EEF) wheelset patent, invented by Professor Friedrich of Aachen University (EEF wheelset technology is described in detail in Chapter 2); and
- Achieve a production price on the order of DM 2.2 million (approximately \$1.5 million at that time).

Although this is not a comprehensive list of Stadtbahn 2000 objectives, it illustrates the wide range of objectives.

Three prototypes, with the characteristics shown in Table 1, were supposed to be built by 1989 and operationally tested by 1991. However, because of technical difficulties in motorizing the EEF wheelsets and obtaining acceptable ride quality, the prototypes were delayed and could not be built in production within the targeted price. Subsequently, the Stadtbahn 2000 project was terminated and none of the prototypes entered production.

In the meantime, several manufacturers collaborated with specific German cities to develop independently their own 100 percent low-floor vehicle, which would fulfill some of the Stadtbahn 2000 objectives. In 1986, the suppliers—MAN (now part of AEG) and Kiepe—began work with the city of Bremen on a 100 percent low-floor design. Successful prototypes were developed for Bremen in 1990 and Munich in 1991. The prototypes have evolved into production vehicles, and the six-axle

TABLE 2 Other 100% low-floor prototype manufacturers/locations

City	Model	Builder	Year of Delivery
Turin		Firema	1989
Milan	S350	Socimi	1989
	LRV 2000	BN	1990
Rome	VLC	Breda	1990
Rome		Socimi	1992
Chemintz	6NGT	ABB Henschel (Waggon Union)	1993
Vienna	ULF 197	SGP/Elin	1994

GT6N and eight-axle GT8N trams have been ordered by eight cities, including Augsburg, Bremen, and Munich. Orders totaled 200 vehicles by 1993, with options for 204 more.(4)

Other manufacturers and cities also experimented with 100 percent low-floor prototypes (Table 2). Some 100 percent low-floor vehicles (Table 3) have been produced directly from design, without the benefit of prototype development.

Production orders that have resulted from 100 percent low-floor prototypes include the following:

- Lille ordered 24 Breda VLCs for delivery in 1993.
- Strasbourg ordered 26 Eurotrams from ABB (Socimi), based on the Rome prototype.
- Chemintz has ordered 53 Variotrams based on the 6NGT.
- Wurzburg has ordered twenty, 100 percent low-floor ve-

TABLE 3 Other 100% low-floor vehicles produced directly from design (without prototypes)

City	Model	Builder	Quantity	Year of Delivery
Frankfurt	R3.1	Duewag	20	1993
Brussels	TRAM 2000	Bombardier (BN)	51	1993-1994

hicles from Linke-Hofmann-Busch (LHB) using the running gear from the Variotram.

- Vienna is expected to order 150 ultra low-floor (ULF) cars from SGP/Elin for delivery in 1996 through 2005, if the ULF prototype performance proves satisfactory.

LF-LRV MARKET STATISTICS

LF-LRV market statistics are useful for understanding trends in the demand for vehicles and the distribution among manufacturers. Data used in this report come from an extensive survey and investigation conducted by Booz • Allen & Hamilton specifically for this study. Information on propulsion and electrical equipment is cited from a 1993 article by Harry Hondius in *Developing Metros* magazine.(5) The distribution of LF-LRVs among manufacturers is shown in Figures 12, 13, and 14 and among propulsion and electrical equipment suppliers in Figure 15.

As described earlier in the report, approximately 75 percent of European orders for new vehicles in the 10 years preceding 1993 were for LF-LRVs. Many of the early procurements were predominantly for Category-1 and Category-2 vehicles. However, for deliveries expected in 1993 or later, Category-3 vehicles nearly match the demand for Category-1 and Category-2 vehicles combined (Tables 4 and 5). The trend in Europe is certainly toward 100 percent low-floor Category-3 vehicles. Additional information on LF-LRVs is provided in Appendix A, which served as the basis for development of Table 4.

The vast majority (97%) of the LF-LRVs have been ordered by European LRT agencies. Figure 16 shows the distribution of LF-LRV orders throughout Europe. A majority of the European orders (88%) have been placed with manufacturers within the transit agency's country of origin. For example, of the 35 orders placed by German transit agencies, one order was placed with a manufacturer outside Germany—Cologne ordered Vienna T-type vehicles from Bombardier (Rotax). French transit agencies have ordered vehicles from Italy (Breda) and Germany (ABB), as well as France (GEC Alsthom). Table 6 shows the vehicle manufacturers and their orders for out-of-country transit systems.

The two companies with the majority of orders for Category-3 vehicles are AEG (MAN) with 37 percent of the total orders and SGP with 28 percent of the total orders. As indicated by their absence from Table 6, neither of these two companies has had an order placed by a transit system outside its country. On the other hand, the company with the majority of orders

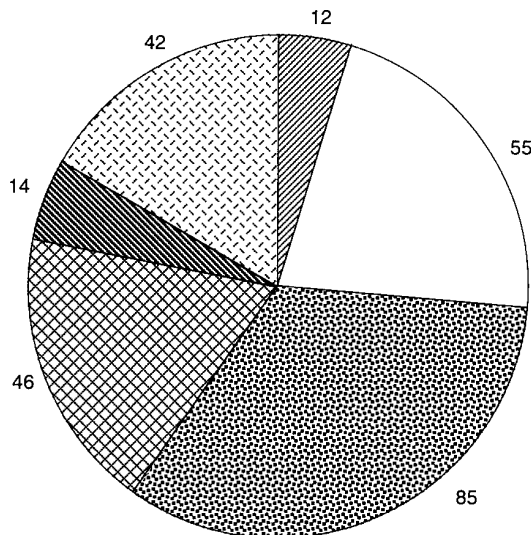


Figure 12. Distribution of Category-1 LF-LRVs by manufacturer.

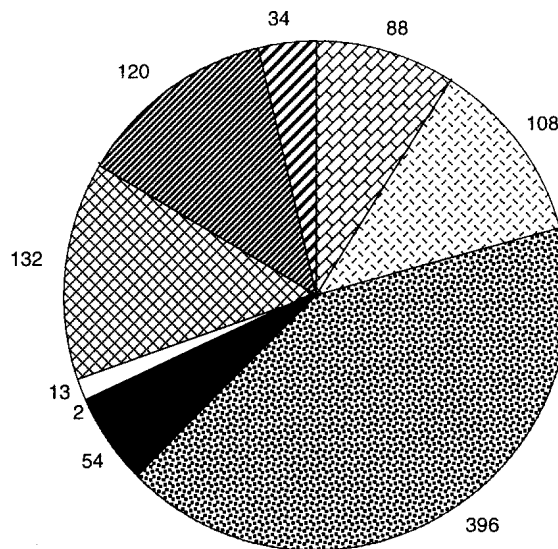


Figure 13. Distribution of Category-2 LF-LRVs by manufacturer.

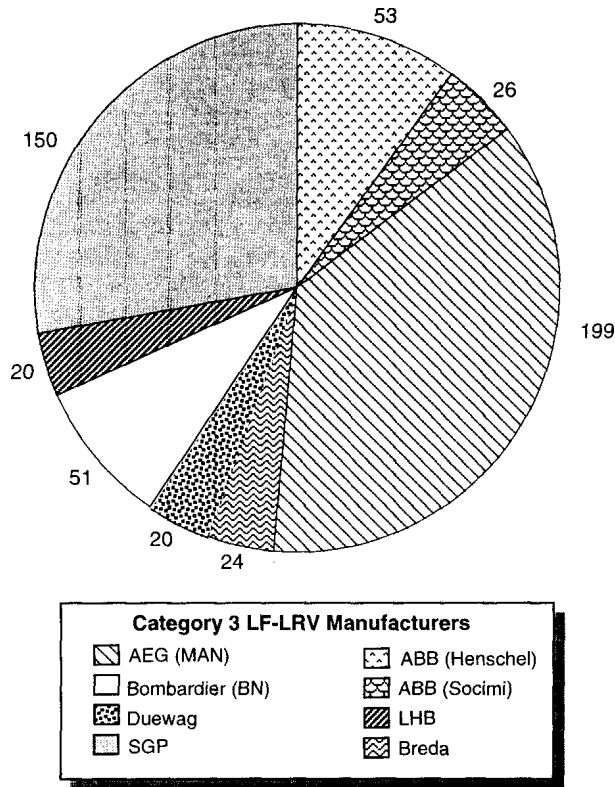


Figure 14. Distribution of Category-3 LF-LRVs by manufacturer.

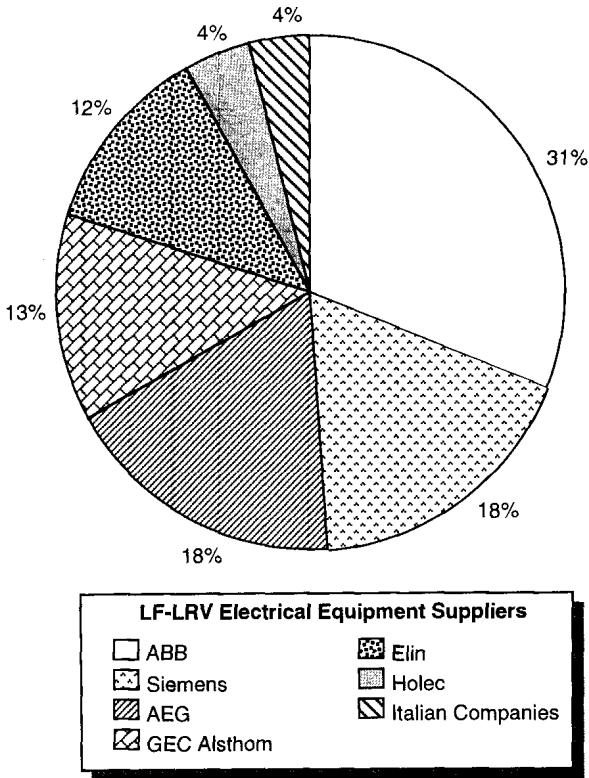


Figure 15. Distribution of LF-LRV market by propulsion and electrical equipment suppliers.

for Category-2 vehicles, Duewag received 20 percent of its orders from outside Germany.

The near-term North American orders are most likely to come from TRI-MET in Portland (order placed with Siemens-Duewag Corporation), the Central Area Circulator Project in Chicago, MBTA in Boston, and TTC in Toronto.

ORGANIZATION OF REPORT

The remainder of this report includes the following:

- Chapter 2, State-of-the-Art Review, defines a classification system that can be easily used to evaluate the state-of-the-art technologies; describes some of the new technologies; and discusses some maintenance and operating experience.
- Chapter 3, Application Considerations, identifies and discusses the significant critical factors that should be examined before considering LF-LRVs. These factors include dimensional compatibility, operating issues, and compliance with North American specifications.
- Chapter 4, Grouping and Characteristics of North American Light Rail Systems, discusses the issues, opportunities, and constraints regarding possible deployment of LF-LRVs at North American LRT systems.
- Chapter 5, Applicability Assessment Framework, defines an applicability assessment model, which demonstrates a process that can be used to define a range of options; then narrows the options to those best suited to a particular transit agency. As a complement to the model, comments in this chapter advise what are the major LF-LRV versus conventional LRV issues, what trade-offs will arise, and what are the most important discriminators between conventional LRVs and LF-LRVs.
- Chapter 6, Case Studies, presents two illustrative examples to show, in a realistic North American context, issues and trade-offs relevant to the choice of LF-LRVs versus conventional LRVs. The first case study is an extension to an existing low-platform LRT system. The second case study is a new LRT system.
- Chapter 7, Conclusions, summarizes the findings of the report and recommends areas for further study.
- Appendix A presents the LF-LRV characteristics database.
- Appendix B presents LRT systems database for 14 North American cities.
- Appendix C, glossary of acronyms and list of transit authorities mentioned in this report.
- Appendix D, bibliography.

TABLE 4 Total number of LF-LRVs produced or on order world-wide (mid-1994), including prototypes

	No. of Vehicles	% of Total
Category 1	254	13%
Category 2	954	52%
Category 3	675	36%
Total	1,883	

TABLE 5 Total number of LF-LRVs produced or on order worldwide (mid-1994), by expected delivery date

	Expected Delivery Prior to 1993			Expected Delivery 1993 or Later		
	No. of Vehicles	% of Total	Average Order	No. of Vehicles	% of Total	Average Order
Category 1	158	27	23	73	6	18
Category 2	394	68	33	583	44	23
Category 3	29	5	11	646	50	38
Total	581			1,302		

TABLE 6 Low-floor vehicle manufacturers with export sales

Vehicle Manufacturer	Manufacturer's Country of Origin	Vehicle Orders Outside Country of Origin	% of Total Company Orders
ABB (Socimi)	U.K./Italy	26	100
Bombardier (BN)	Belgium	45	42
Bombardier (Rotax)	Austria	40	37
Breda	Italy	24	100
Duewag	Germany	104	20

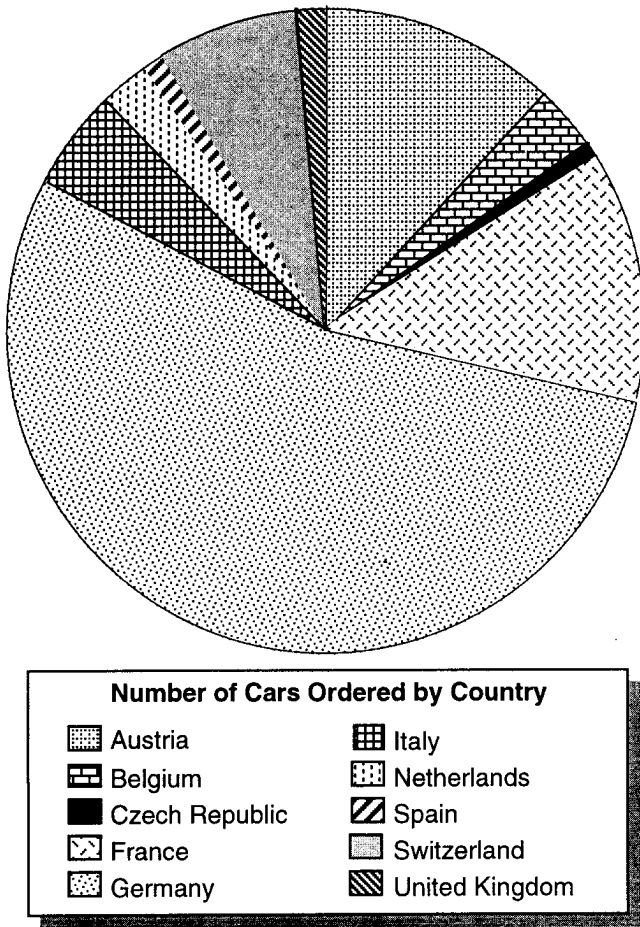


Figure 16. Distribution of Category-3 LF-LRV orders in Europe by country.

CHAPTER 2

STATE-OF-THE-ART REVIEW

To describe the applicability of low-floor light rail vehicles (LF-LRVs) to North American transit systems, it is necessary to develop a classification system and a vernacular to facilitate discussion of state-of-the-art technologies. This chapter begins by defining a classification system, first introduced in Chapter 1, that covers LF-LRVs manufactured or ordered to date. Representative models in each category are described. A detailed list of characteristics (if known) is provided for each vehicle in Appendix A.

As stated previously, Category-2 and Category-3 LF-LRVs have increased the proportion of low-floor area through the use of innovative running gear design and high technology propulsion equipment, particularly motors and gearboxes. These and other new technologies are described in detail in this chapter.

Because LF-LRVs have a short service history, it has been difficult to obtain objective data on reliability, maintainability, and operating cost. Some anecdotal evidence has been collected and is presented in the last section of this chapter.

CLASSIFICATION SYSTEM

The classification system used is based primarily on type of running gear:

Category 1—Vehicles with conventional motor and trailer trucks throughout.

Category 2—Vehicles with conventional motor trucks at each end; and in between them either:

- Small wheel trailer trucks; or
- Independently rotating wheel trailer running gear arranged as:
 - Four independent wheel trucks (with or without cranked axles), or
 - Self-steering wheelsets (including EEF wheelsets described in detail later in Chapter 2); or
- Single-axle conventional wheelsets.

Category 3—Vehicles with innovative motored and trailing running gear throughout.

Figure 17 shows the various wheelset and drive arrangements for both conventional LRVs and the three categories of LF-LRVs. More detail on the use of these wheelset and drive

arrangements for each of the three categories of LF-LRVs is provided in the vehicle characteristics compendium section.

The classification system was selected for the following reasons:

- The majority of LRT systems that may be considering LF-LRVs are existing systems, with existing vehicles and facilities. For these systems, the proposed categories represent increasing application complexity and change from existing practices.
- The three categories correspond to the proportion of low-floor area, which is an important characteristic from an operational viewpoint:
 - **Category 1**—generally 9 percent to 15 percent low floor, but up to 48 percent low-floor area;
 - **Category 2**—generally 50 percent to 75 percent uninterrupted low-floor area between motor trucks; and
 - **Category 3**—100 percent low-floor areas and low-level entrances throughout the vehicle (the one exception is the Breda VLC).
- The three categories represent increasing levels of technological innovation and, therefore, application risk.

CHARACTERISTICS COMPENDIUM

Research for this project identified 42 vehicle designs, including 8 prototypes. The known characteristics of each vehicle were entered into a computer database (see Appendix A).

Table 7 shows a summary of vehicle characteristics for vehicles in service or on order. The vehicles are sorted by category. The table should be read in conjunction with Figure 17 regarding detailed running gear arrangements. Axle arrangement terminology is described in the glossary.

It was not possible to ascertain all the characteristics for every vehicle during this research effort. In particular, price information was not always available. However, Table 7 and Appendix A provide a significant level of information regarding the characteristics of LF-LRVs. In addition, a discussion of published and reported prices is provided in this chapter.

DETAILED DESCRIPTIONS OF LF-LRVs

This section describes in greater detail the configuration and attributes of representative vehicles in each of the three previously defined categories. More than one vehicle is described

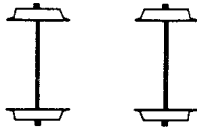
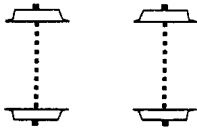
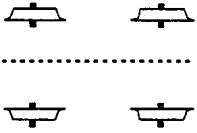
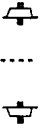
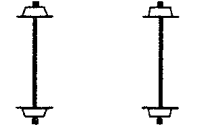



<p>Trailing Gear Code <u>I1</u></p> <p>Trailing Gear Type Conventional two-axle</p>	
<p>Trailing Gear Code <u>I2</u></p> <p>Trailing Gear Type Independent wheels on two cranked axle trailer truck</p>	
<p>Trailing Gear Code <u>I3</u></p> <p>Trailing Gear Type Four independent wheel trailer truck</p>	
<p>Trailing Gear Code <u>I4</u></p> <p>Trailing Gear Type Single wheelset with small independent wheels built into articulation</p>	
<p>Trailing Gear Code <u>I6</u></p> <p>Trailing Gear Type Small wheel trailer truck</p>	
<p>Trailing Gear Code <u>I5</u></p> <p>Trailing Gear Type Single-axle conventional wheelset steered by articulation</p>	
<p>Trailing Gear Code <u>I7</u></p> <p>Trailing Gear Type Single wheelset steered by the articulation</p>	
<p>Trailing Gear Code <u>I8</u></p> <p>Trailing Gear Type EEF wheelset</p>	

Figure 17. Conventional and LF-LRV wheelset and drive arrangements.

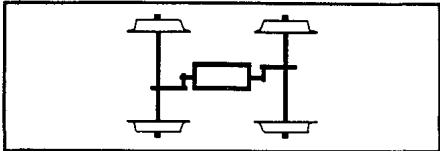
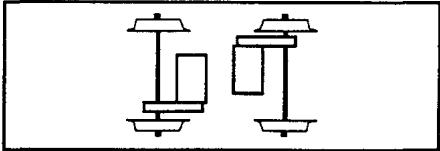
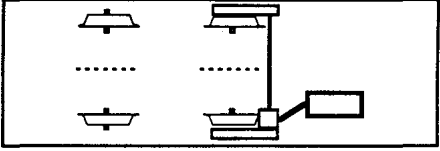
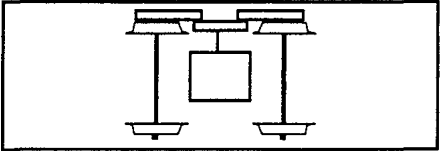
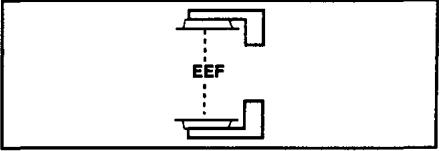
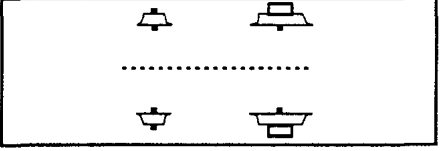
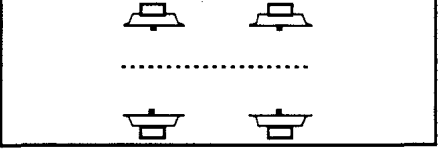
<p>Power Gear Code <u>M1</u></p>	<p>Power Gear Type Conventional monomotor</p>	
<p>Power Gear Code <u>M2</u></p>	<p>Power Gear Type Conventional bi-motor</p>	
<p>Power Gear Code <u>M3</u></p>	<p>Power Gear Type Independent wheels, one pair driven, one pair free-wheeling</p>	
<p>Power Gear Code <u>M4</u></p>	<p>Power Gear Type Transverse-mounted motor drives both axles through parallel gears and cardan shaft</p>	
<p>Power Gear Code <u>M5</u></p>	<p>Power Gear Type Motored EEF self-steering wheelset</p>	
<p>Power Gear Code <u>M6</u></p>	<p>Power Gear Type Articulated truck frame, two large hub motor-driven wheels, two small guiding wheels</p>	
<p>Power Gear Code <u>M7</u></p>	<p>Power Gear Type Four hub motor-driven, independent wheels</p>	

Figure 17. Conventional and LF-LRV wheelset and drive arrangements (continued).

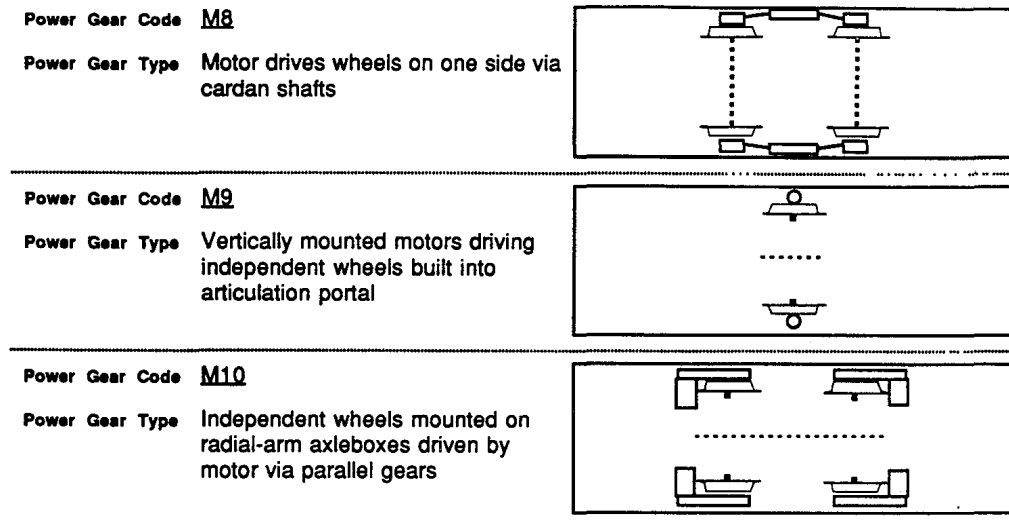


Figure 17. Conventional and LF-LRV wheelset and drive arrangements (continued).

in each category in order to examine the differences in technology. This is especially relevant for Category-2 vehicles, because a number of different wheel/axle technologies are used, and for Category-3 vehicles, because various traction motor technologies are used.

Category-1 Vehicles

Category-1 vehicles have conventional motor and trailer trucks throughout the vehicle. Category-1 vehicles generally have 9 to 15 percent low-floor area but can have up to 48 percent. Two representative vehicles from Category 1 are described in the following.

Wurzburg-Type GT8/8C. The city of Wurzburg, Germany, operates 14 eight-axle LF-LRVs. These vehicles were supplied in 1989 by Linke-Hofmann-Busch of Germany and use Siemens electrical equipment. This vehicle is shown in Figure 18. The design philosophy follows the basic approach of inserting an intermediate section between the two halves of a conventional LRV. The extended vehicle has four trucks instead of the original three trucks, and two articulations instead of the original one articulation. However, the articulations are not directly supported by a truck. All four monomotor trucks are of conventional monomotor design—driven by a single, three-phase, AC, asynchronous induction motor.

All vehicle equipment is fitted to the underside of the two outer sections of the vehicle. The low floor in the intermediate section comprises 9 percent of the total floor area. The vehicle is unidirectional. Five entrance doorways are provided on one side of the vehicle only. The center door provides direct access to the low-floor area, which provides sufficient space for one or two wheelchairs. Internal access to the remainder of the vehicle is provided by steps at either end of the low-floor area.

Similar vehicles of this type are running in Freiburg and

Mannheim, Germany, and Basel, Switzerland. The advantages of this design are

- Proven and familiar technology;
- Underfloor equipment mounting, which allows use of existing maintenance workshop layout and equipment;
- Existing six-axle vehicles, which may be converted to this design, thereby cost-effectively achieving increased capacity and accessibility; and
- Maximum use of adhesion to provide high acceleration, even on steep grades, when all axles are powered.

Disadvantages are as follows:

- The low-floor area is small (15% maximum).
- There are internal steps or ramps between the high- and low-floor areas.
- Vehicle length may exceed maintenance shops or existing low platforms or block road intersections.
- Lower performance can result if not all trucks are powered.
- Vehicles are unidirectional.

Sheffield "Supertram." The city of Sheffield, England, operates 25 eight-axle LF-LRVs. These vehicles were supplied between 1992 and 1993 by Duewag of Germany and use Siemens electrical equipment. This vehicle is shown in Figure 19. The design has three articulated sections and four motored trucks. The vehicle differs from the Wurzburg design in that the low floor is in the outer carbody sections and the center section has a high floor. All four trucks are of the conventional Siemens monomotor design, driven by a chopper-controlled DC traction motor. Vehicle equipment is fitted to the underside of the center section. This arrangement achieves a 34 percent low-floor area.

There are four entrance doors on one side. Each door leads

TABLE 7 Summary of Category-1, Category-2, and Category-3 LF-LRVs

Category-1 Low Floor LRVs															
City	Builder	Type	Axle Arrangement*	Number of Cars	% Low Floor	Car Length (m ft)	Car Width (m ft)	Floor Max (mm in)	Height Min (mm in)	Weight (tonne lbs)	Max Speed (km/h mph)	Min Curve Radius (m, ft)	Running Type Power	Gear Trailer	First Car
Mannheim	Duewag	N/A	B'2'2'B'	23	9%	25.7 84.2	2.2 7.2	889 35	353 13.9	26 57,320	60 37	25 82	M1	T1	1991
Amsterdam/ GVBA	Bombardier (BN)	11G & 12G	Bo'Bo'Bo'Bo'	45	9%	25.6 84.1	2.4 7.7	870 34.3	280 11	36.9 81,351	70 44	25 82	M2		1989
Freiburg/ VAG	Duewag	GT 8C	B'B'B'B'	11	9%	32.8 107.7	2.3 7.5	910 35.8	270 10.6	38.5 84,878	70 44	25 82	M1		1990
Nurnberg	AEG (MAN)	N82	B'2'2'B'	12	9%	26.1 85.6	2.3 7.5	880 34.6	284 11.2	32.8 72,312	70 44	25 82	M1	T1	1992
Wurzburg	LHB	GT 8/8C	B'B'B'B'	14	10%	32.6 107	2.4 7.9	910 35.8	310 12.2	42.5 93,697	70 44	25 82	M1		1989
Antwerp/ De Lijn	Bombardier (BN)	N/A	B'2'2'B'	10	10%	29.3 96.1	2.3 7.5	860 33.9	350 13.8	42 92,594	80 50	N/A	M1	T1	1993
Basle/ BVB	Schindler (SIG)	Be 4/4	B'2'2'B'	19	15%	25.4 83.3	2.2 7.2	855 33.7	325 12.8	31 68,343	65 40	12 39.4	M1	T1	1987
Nantes/ SEMITAN	GEC Alsthom	N/A	B'2'2'B'	34	16%	39.2 128.4	2.3 7.5	873 34.4	353 13.9	51.9 114,420	70 44	25 82	M1	T1	1992
Nantes/ SEMITAN	GEC Alsthom	N/A	B'2'2'B'	12	18%	39.2 128.4	2.3 7.5	850 33.5	350 13.8	51.6 113,759	70 44	N/A	M1	T1	1993
Sheffield/ SYST	Duewag	GT 8	B'B'B'B'	25	34%	34.8 114	2.7 8.7	880 34.6	480 18.9	46 101,413	80 50	25 82	M1		1993
Freiburg	Duewag	GT8D-MNZ	Bo'Bo'Bo'Bo'	26	48%	33.1 108.6	2.3 7.5	560 22	290 11.4	38.5 84,878	70 44	19 62.3	M2		1993
RBS	Schindler (SIG)	ABe4/8	Bo'2'2'Bo'	23	50%	39.3 128.9	2.7 8.7	830 32.7	390 15.4	51 112,436	90 56	N/A	M2	T1	1992

Sum of Category 1 Cars Ordered 254

* See glossary for definitions

TABLE 7 Summary of Category-1, Category-2, and Category-3 LF-LRVs (continued)

Category-2 Low Floor LRVs															
City	Builder	Type	Axle Arrangement*	Number of Cars	% Low Floor	Car Length (m/ft)	Car Width (m/ft)	Floor Max (mm/in)	Height Min (mm/in)	Weight (tonne/lbs)	Max Speed (km/h/mph)	Min Curve Radius (m,ft)	Running Type	Gear Type	First Car
Trailing Gear: Independent wheels on two cranked axle trailer truck															
Portland	Siemens-Duewag	N/A	Bo'2Bo'	46	66%	28.0 92	2.7 8.7	980 38.6	355 14	44 97,003	88 55	25 82	M2	T2	1995
Grenoble/SEMITAG	GEC Alsthom	ZR 2000	B'2'B'	38	65%	29.4 96.5	2.3 7.5	875 34.4	345 13.6	43.9 96,783	70 44	25 82	M1	T2	1987
Grenoble/SEMITAG	GEC Alsthom	ZR 2000	B'2'B'	7	65%	29.4 96.5	2.3 7.5	875 34.4	345 13.6	43.9 96,783	70 44	25 82	M2	T2	1995
Pans/SEMITAG	GEC Alsthom	ZR 2000	B'2'B'	17	65%	29.4 96.5	2.3 7.5	875 34.4	345 13.6	43.9 96,783	70 44	25 82	M1	T2	N/A
Rouen/SEMITAG	GEC Alsthom	ZR 2000	B'2'B'	28	65%	29.4 96.5	2.3 7.5	875 34.4	345 13.6	43.9 96,783	70 44	25 82	M1	T2	1993
Val de Seine/SEMITAG	GEC Alsthom	ZR 2000	B'2'B'	17	65%	29.4 96.5	2.3 7.5	875 34.4	345 13.6	43.9 96,783	70 44	25 82	M1	T2	N/A
Trailing Gear: Four independent wheel trailer truck															
Turin/ATM	Fiat (Firema)	5000	B'2'B	54	56%	22.2 72.8	2.3 7.5	870 34.3	350 13.8	30 66,139	60 37	16 52.5	M1	T3	1989
Dresden	Duewag	6MGT	Bo'22Bo'	20	64%	40.5 132.9	2.4 7.9	600 23.6	350 13.8	42 92,594	70 44	15 49.2	M2	T3	N/A
Mannheim	Duewag	6MGT	Bo'2Bo'	64	64%	29.9 98.1	2.4 7.9	600 23.6	350 13.8	33 72,753	70 44	15 49.2	M2	T3	1994
Mannheim	Duewag	6MGT	Bo'22Bo'	5	64%	40.5 132.9	2.4 7.9	600 23.6	350 13.8	42 92,594	70 44	15 49.2	M2	T3	1994
Mannheim	ABB Henschel	6NGT/ Varotram	N/A	2	70%	N/A	N/A	N/A	290 11.4	N/A	N/A	N/A	M2	T3	1996
Karlsruhe	Duewag	70D/N	Bo'2Bo'	20	61%	28.8 94.6	2.7 8.7	580 22.8	390 15.4	34.5 76,060	80 50	N/A	M2	T3	1994
Buenos Aires	Duewag	N/A	Bo'2Bo'	9	62%	23.8 78	2.4 7.9	560 22	350 13.8	29.7 65,477	70 44	25 82	M2	T3	1994
Valencia	Duewag	N/A	Bo'2Bo'	24	62%	23.8 78	2.4 7.9	560 22	350 13.8	29.7 65,477	65 40	20 65.6	M2	T3	1994
Brno City Transport	CKD Tatra	RT6-N1	Bo'2Bo'	12	63%	26.3 86.2	2.4 8	900 35.4	350 13.8	32 70,548	80 50	25 82	M2	T3	N/A
Prototype	CKD Tatra	RT6-N1	Bo'2Bo'	1	63%	26.3 86.2	2.4 8	900 35.4	350 13.8	32 70,548	80 50	25 82	M2	T3	1993
Rome/ATAC	Socimi	T8000	Bo'2Bo'	34	54%	21.2 69.6	2.3 7.5	835 32.9	350 13.8	29.7 65,477	70 44	15 49.2	M2	T3	1990
Trailing Gear: Single-axle conventional wheelset steered by articulation															
Cologne	Bombardier (Rotax)	T	Bo'1'1'Bo'	40	60%	26.8 87.9	2.7 8.7	530 20.9	440 17.3	34.7 76,500	80 50	20 65.6	M2	T5	N/A
Vienna U-Bahn	Bombardier (Rotax)	T	Bo'1'1'Bo'	68	60%	26.8 87.9	2.7 8.7	530 20.9	440 17.3	34.7 76,500	80 50	20 65.6	M2	T5	1992

* See glossary for definitions

TABLE 7 Summary of Category-1, Category-2, and Category-3 LF-LRVs (continued)

Category-2 Low Floor LRVs															
City	Builder	Type	Axle Arrangement*	Number of Cars	% Low Floor	Car Length (m / ft)	Car Width (m / ft)	Floor Max (mm / in)	Height Min (mm / in)	Weight (tonne / lbs)	Max Speed (km/h / mph)	Min Curve Radius (m, ft)	Running Gear Type	Gear Trailer	First Car
Trailing Gear: Small wheel trailer truck															
Leipzig	Duewag	8NGT	Bo'2'2'Bo'	25	61%	27.8 / 91.2	2.2 / 7.2	560 / 22	300 / 11.8	32 / 70,548	70 / 44	N/A	M2	T6	1994
Swiss-Italian Railway/ FART	ACM Vevey	ABe4/6	Bo'2'Bo'	12	60%	30.3 / 99.4	2.7 / 8.7	900 / 35.4	530 / 20.9	42.5 / 93,697	80 / 50	N/A	M2	T6	1992
Geneva/ TPG	ACM Vevey	Be4/6	B'2'B'	46	60%	21.0 / 68.9	2.3 / 7.5	870 / 34.3	480 / 18.9	27 / 59,525	60 / 37	17.5 / 57.4	M1	T6	1984
St. Etienne/ STAS	GEC Alsthom	Be4/6	B'2'B'	25	59%	23.2 / 76.2	2.1 / 6.9	710 / 28	350 / 13.8	27.4 / 60,407	70 / 44	18 / 59.1	M1	T6	1991
Bern/ SVB	ACM Vevey	Be4/8	B'2'2'B'	12	73%	31.0 / 101.7	2.2 / 7.2	710 / 28	350 / 13.8	34 / 74,957	60 / 37	15 / 49.2	M1	T6	1989
Geneva	ACM Vevey	Be4/8 Intermediate	N/A	18	N/A	N/A	N/A	N/A	350 / 13.8	N/A	N/A	N/A	M1	T6	1995
Magdeburg	LHB	NGT 8D	Bo'2'2'Bo'	120	60%	29.0 / 95.1	2.3 / 7.5	570 / 22.4	350 / 13.8	34 / 74,957	70 / 44	N/A	M2	T6	1995
Trailing Gear: EEF wheelset															
Rostock	Duewag	6NGTWDE	Bo'1'1'Bo'	50	50%	30.4 / 99.7	2.3 / 7.5	560 / 22	350 / 13.8	30.4 / 67,021	70 / 44	15 / 49.2	M2	T8	1994
Bogestra/ Bochum	Duewag	MGT6D	Bo'1'1'Bo'	43	65%	28.6 / 93.9	2.3 / 7.5	560 / 22	350 / 13.8	32 / 70,548	70 / 44	15 / 49.2	M2	T8	1992
Brandenburg	Duewag	MGT6D	Bo'1'1'Bo'	4	65%	28.6 / 93.9	2.3 / 7.5	560 / 22	350 / 13.8	32 / 70,548	70 / 44	15 / 49.2	M2	T8	N/A
Erfurt	Duewag	MGT6D	Bo'1'1'Bo'	4	65%	28.6 / 93.9	2.3 / 7.5	560 / 22	350 / 13.8	32 / 70,548	70 / 44	15 / 49.2	M2	T8	N/A
Halle	Duewag	MGT6D	Bo'1'1'Bo'	14	65%	28.6 / 93.9	2.3 / 7.5	560 / 22	350 / 13.8	32 / 70,548	70 / 44	15 / 49.2	M2	T8	1992
Heidelberg	Duewag	MGT6D	Bo'1'1'Bo'	12	63%	28.9 / 94.9	2.3 / 7.5	540 / 21.3	350 / 13.8	31.5 / 69,446	70 / 44	15 / 49.2	M2	T8	1994
Mulheim	Duewag	MGT6D	Bo'1'1'Bo'	4	65%	28.6 / 93.9	2.3 / 7.5	560 / 22	350 / 13.8	32 / 70,548	70 / 44	15 / 49.2	M2	T8	N/A
Kassel/ KVG	Duewag	NGT6C	B'1'1'B'	25	70%	28.8 / 94.3	2.3 / 7.5	700 / 27.6	350 / 13.8	30.2 / 66,580	70 / 44	15 / 49.2	M1	T8	1990
Bonn	Duewag	NGT6D	Bo'1'1'Bo'	24	65%	28.6 / 93.9	2.3 / 7.5	560 / 22	350 / 13.8	31.5 / 69,446	70 / 44	15 / 49.2	M2	T8	1994
Dusseldorf	Duewag	NGT6D	Bo'1'1'Bo'	10	65%	28.6 / 93.9	2.3 / 7.5	560 / 22	350 / 13.8	31.5 / 69,446	70 / 44	15 / 49.2	M2	T8	N/A
Sum of Category 2 Cars Ordered 954															

* See glossary for definitions

TABLE 7 Summary of Category-1, Category-2, and Category-3 LF-LRVs (continued)

Category-3 Low Floor LRVs															
City	Builder	Type	Axle Arrangement*	Number of Cars	% Low Floor	Car Length (m ft)	Car Width (m ft)	Floor Max (mm in)	Height Min (mm in)	Weight (tonne lbs)	Max Speed (km/h mph)	Min Curve Radius (m, ft)	Running Type	Gear Trailer	First Car
Power Gear: Unknown															
Prototype (Turin)	Firema	Prototype	Bo'2'Bo'	1	100%	22.2 72.8	2.3 7.5	350 13.8	350 13.8	24 52,911	90 56	N/A		T3	N/A
Power Gear: Independent wheels mounted on radial-arm axleboxes driven by motor via parallel gears															
Strasbourg	ABB (Socimi)	Eurotram	BoBoBo2	26	100%	32.5 106.6	2.4 7.9	350 13.8	350 13.8	29 63,934	60 37	N/A	M10	T3	1994
Prototype (Rome)	Socimi	N/A	BoBoBo	1	100%	22.0 72.2	2.4 7.9	350 13.8	350 13.8	25 55,116	60 37	25 82	M10		1992
Prototype (Milan)	Socimi	S-350LRV	Bo'Bo'	1	100%	14.0 45.9	2.4 7.9	350 13.8	350 13.8	10.5 23,149	70 44	15 49.2	M10		1989
Power Gear: Independent wheels, one pair driven, one pair free-wheeling															
Augsburg	AEG (MAN)	GT6M	1A'A1'A1'	1	100%	26.5 86.9	2.3 7.5	350 13.8	300 11.8	29.6 65,257	70 44	15 49.2	M3		1993
Berlin	AEG (MAN)	GT6N	1A'A1'A1'	120	100%	26.5 86.9	2.3 7.5	350 13.8	300 11.8	26.8 59,084	70 44	15 49.2	M3		1994
Braunschweig	AEG (MAN)	GT6N	1A'A1'A1'	11	100%	26.5 86.9	2.3 7.5	350 13.8	300 11.8	26.8 59,084	70 44	15 49.2	M3		N/A
Bremen	AEG (MAN)	GT6N	1A'A1'A1'	18	100%	26.5 86.9	2.3 7.5	350 13.8	300 11.8	26.8 59,084	70 44	15 49.2	M3		1990
Frankfurt-an-der-Oder	AEG (MAN)	GT6N	1A'A1'A1'	13	100%	26.5 86.9	2.3 7.5	350 13.8	300 11.8	26.8 59,084	70 44	15 49.2	M3		N/A
Halle	AEG (MAN)	GT6N	1A'A1'A1'	1	100%	26.5 86.9	2.3 7.5	350 13.8	300 11.8	26.8 59,084	70 44	15 49.2	M3		N/A
Munich	AEG (MAN)	GT6N	1A'A1'A1'	70	100%	27.3 89.6	2.3 7.5	350 13.8	300 11.8	29.4 64,816	70 44	15 49.2	M3		1994
Zwickau	AEG (MAN)	GT6N	1A'A1'A1'	12	100%	26.5 86.9	2.3 7.5	350 13.8	300 11.8	26.8 59,084	70 44	15 49.2	M3		N/A
Munich	AEG (MAN)	GT6N/ R1.1	1A'A1'A1'	3	100%	26.5 86.9	2.3 7.5	350 13.8	300 11.8	29.5 65,036	70 44	15 49.2	M3		1990
Bremen	AEG (MAN)	GT8N	1A'1A'1A'1A'	61	100%	35.0 114.8	2.3 7.5	350 13.8	300 11.8	34 74,957	70 44	15 49.2	M3		1993
Jena	AEG (MAN)	GT8N	1A'1A'1A'1A'	10	100%	35.0 114.8	2.3 7.5	350 13.8	300 11.8	34 74,957	70 44	15 49.2	M3		N/A
Power Gear: Transverse-mounted motor drives both axles through parallel gears and cardan shaft															
Lille	Breda	VLC	B'1 1 1 B'	24	80%	29.9 98.1	2.4 7.9	950 37.4	350 13.8	40 88,185	70 44	25 82	M4	T4	1993
Prototype (Rome)	Breda	VLC	B'1 1 B'	1	75%	22.0 72.2	2.5 8.2	950 37.4	350 13.8	22 48,502	70 44	20 65.6	M4	T4	1990

* See glossary for definitions

TABLE 7 Summary of Category-1, Category-2, and Category-3 LF-LRVs (continued)

Category-3 Low Floor LRVs				Number of Cars	% Low Floor	Car Length (m ft)	Car Width (m ft)	Floor Max (mm in)	Height Min (mm in)	Weight (tonne lbs)	Max Speed (km/h mph)	Min Curve Radius (m, ft)	Running Type Power	Gear Trailer	First Car
City	Builder	Type	Axle Arrangement*												
Power Gear: Motored EEF self-steering wheelset															
Mannheim/ MVG	German Consortium	dGTW-ER	A'A'A'1'	1	100%	26.7 87.6	2.3 7.5	350 13.8	290 11.4	23.98 52,867	70 44	15 49.2	M5	T8	1991
Dusseldorf/ RBG	German Consortium	GTW-ER	A'A'1'	1	100%	20.2 66.2	2.4 7.9	350 13.8	290 11.4	17.75 39,132	70 44	18 59.1	M5	T8	1991
Bonn/SWB	German Consortium	GTW-ZR	A'A'1'	1	100%	20.2 66.2	2.4 7.9	350 13.8	290 11.4	18.56 40,918	70 44	18 59.1	M5	T8	1991
Power Gear: Articulated truck frame, two large hub motor-driven wheels, two small guiding wheels															
Prototype	Bombardier (BN)	LRV2000	A'1'1'A'1'A'	1	100%	20.2 66.3	2.5 8.1	350 13.8	350 13.8	24 52,911	70 44	N/A	M6		1990
Brussels	Bombardier (BN)	TRAM2000	A'1'Bo1'A'	51	100%	22.8 74.8	2.3 7.5	350 13.8	350 13.8	31.9 70,328	70 44	17.5 57.4	M6		1994
Power Gear: Four hub motor-driven, independent wheels															
Chemnitz	ABB Henschel	6NGT/ Variotram	Bo'2'Bo'	53	100%	30.9 101.4	2.7 8.7	350 13.8	290 11.4	28.3 62,391	70 44	18 59.1	M7	T3	1993
Wurzburg	LHB	GTW	Bo'Bo'Bo'	20	100%	29.1 95.5	2.4 7.9	350 13.8	300 11.8	35 77,162	80 50	N/A	M7		N/A
Frankfurt am Main	Duewag	R3.1	Bo'2'Bo'	20	100%	27.2 89.2	2.4 7.7	350 13.8	300 11.8	33 72,753	70 44	18 59.1	M7	T3	1993
Power Gear: Motor drives wheels on one side via cardan shafts															
Prototype	Schndler (SIG)	Cobra 370	A'A'A'A'	1	100%	24.5 80.4	2.3 7.5	370 14.6	320 12.6	25 55,116	65 40	11.8 38.7	M8		1993
Power Gear: Vertically mounted motors driving independent wheels built into articulation portal															
Vienna "A"	SGP	ULF197-4	1'A'A'A'1'	100	100%	23.6 77.5	2.4 7.9	197 7.8	197 7.8	23 50,706	70 44	18 59.1	M9	T7	1995
Vienna "A" Prototype	SGP	ULF197-4	1'A'A'A'1'	1	100%	23.6 77.5	2.4 7.9	197 7.8	197 7.8	23 50,706	70 44	18 59.1	M9	T7	1994
Vienna "B"	SGP	ULF197-6	1'A'A'A'A'1'	50	100%	34.9 114.4	2.4 7.9	197 7.8	197 7.8	32.5 71,650	70 44	18 59.1	M9	T7	1995
Vienna "B" Prototype	SGP	ULF197-6	1'A'A'A'A'1'	1	100%	34.9 114.4	2.4 7.9	197 7.8	197 7.8	32.5 71,650	70 44	18 59.1	M9	T7	1994
Sum of Category 3 Cars Ordered 675															

* See glossary for definitions

to a low-floor area. The high-floor areas at the outer ends and center of the vehicle are accessed by interior steps. The advantage of this vehicle over the Wurzburg-type is increased low-floor area that can be accessed at every entrance door. The disadvantages are that the low-floor area is still small (compared to Category-2 and Category-3 vehicles) and discontinuous, being separated by the central high-floor section.

Category-2 Vehicles

Category-2 vehicles have conventional motor trucks at each end with either small wheel trailer trucks or independently rotating wheel running gear between motor trucks. Generally, Category-2 vehicles have 50 to 75 percent uninterrupted low-floor area between motor trucks. Unlike some of the vehicles in Category 1, it is not possible to have all axles motored. Consequently, the vehicles may have somewhat lower specific power. Three types of Category-2 vehicles are described in the following paragraphs.

Geneva/Bern-Type Be4/6 and Be 4/8 LF-LRVs. The city of Geneva, Switzerland, operates a total of 46 six-axle (Be 4/6) LF-LRVs, supplied between 1984 and 1990 by Duewag of Germany (Figures 20 through 24). The vehicles have two sections with conventional Duewag monomotor trucks, driven by DC traction motors at the outer ends. The articulation joint connecting them rides on a compact, two-axle trailer truck, using small wheel technology supplied by Vevey. The small diameter of the wheels permits the floor of the intermediate section to be completely at low level and the vehicle has a 60 percent low-floor area. The advantage of this design is a much greater and continuous low-floor area. The disadvantage is that internal steps are still necessary to reach the high-floor area at the car ends. All vehicle equipment is located at roof level.

The city of Bern, Switzerland, operates a fleet of 12 similar vehicles—designated Be 4/8. These vehicles, delivered between 1989 and 1990, are 31 m (102 ft) long. The difference between the Be4/6 and Be4/8 vehicles is that the Be4/8 has a longer intermediate section that rides on two, two-axle small wheel trucks. This longer intermediate section provides additional low-floor area, increasing the proportion of low-floor area to 73 percent.

Grenoble, Rouen, and Paris. The cities of Grenoble, Rouen, and Paris in France operate a total of 75 six-axle LF-LRVs. These vehicles are shown in Figures 25 through 31. The vehicles were supplied by GEC-Alsthom and were delivered between 1987 and 1993. The vehicles have three sections and are 29.4 m (96.5 ft) long. The two outer motor trucks are conventional monomotor design, driven by chopper-controlled DC traction motors. The short middle section rides on a low-transom trailer truck with two cranked axles, giving a cavity

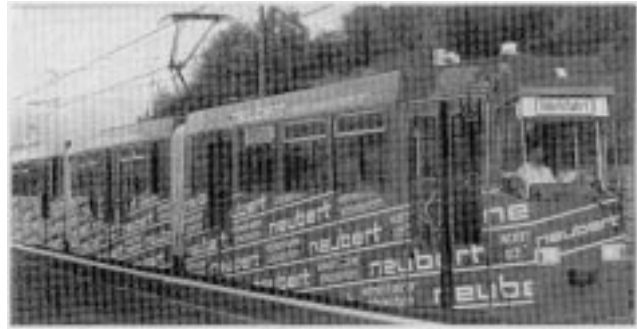


Figure 18. Wurzburg-type GT8/8C LF-LRV.



Figure 19. Sheffield "Supertram" LF-LRV (photo).

between the independently rotating wheels and thereby enabling the low-floor gangway to run in between them. The wheels on the trailer axles are the same size as those on the motored trucks. Longitudinal seats are placed along the sides of the middle section to provide space under them for the trailer wheels, which are higher than the low floor. Most vehicle equipment is located at roof level. The proportion of low-floor area achieved is 65 percent. The advantage of this design is the increased, uninterrupted floor area. However, it is still necessary to have a high-floor area above the motored trucks. The vehicle is equipped with small powered ramps (Figure 32). When deployed, the ramps bridge the gap between the vehicle's low floor, which is 345 mm (13.6 in) above TOR, and the lowstation platforms.

Kassel Transit Authority Type NGT 6C. The city of Kassel, Germany, operates 25 LF-LRVs (Figures 33 through 37). The vehicles were supplied by Duewag with Siemens and AEG-Westinghouse electrical equipment and were delivered beginning in 1990. The vehicles are 28.75 m (94 ft) long and comprise three sections. The outer sections ride on conventional two-axle monomotor trucks with DC traction motors. The intermediate section rides on two independent self-steering EEF

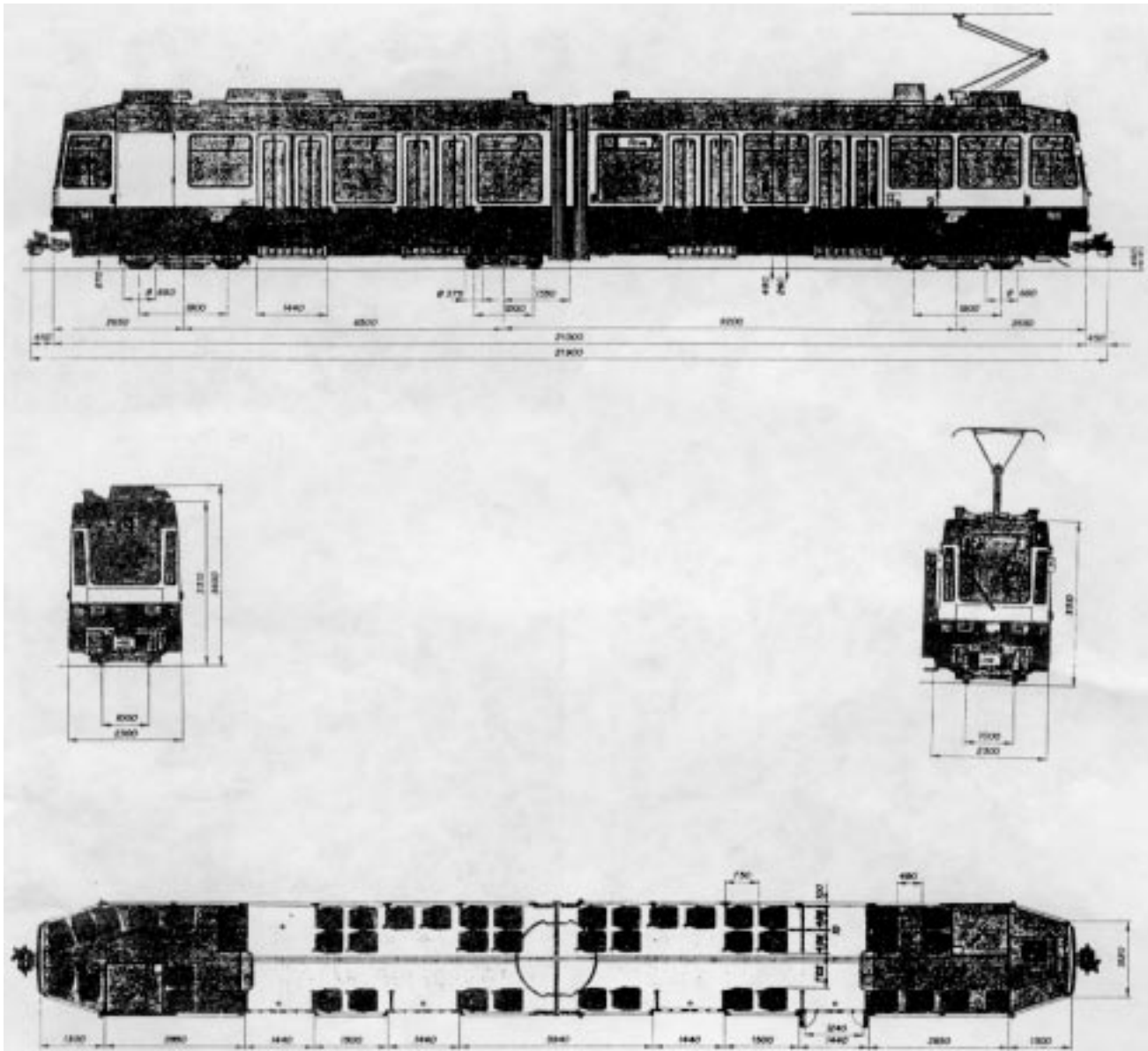


Figure 20. Geneva-type Be4/6 LF-LRV (schematic).

wheelsets. This arrangement minimizes the intrusion of the EEF wheels into the passenger compartment, providing a continuous low-floor area of 70 percent that is 350 mm (13.8 in) above TOR, with entrance thresholds at 290 mm (11.4 in) above TOR. The high floor above the motor trucks is 720 mm (28.3 in) above TOR. All equipment is located at roof level.

The EEF wheelsets are manufactured by BSI and equipped with resilient wheels (Figures 38, 39, and 40). These were developed from experimental prototypes, which were tested in service, and provide very good ride quality with improved reliability.

Duewag has also built a bidirectional variant of the NGT 6C for the city of Bochum, which is driven by smaller AC motors fitted in very compact, meter-gauge, bimotor trucks (Figure 41). The floor over these end motor trucks is only 590 mm (23.3 in) above TOR.

Category-3 Vehicles

Category-3 vehicles have innovative motored and trailing running gear, up to 100 percent low-floor areas, and low-level entrances throughout the vehicle. Five types of Category-3 vehicles are described in the following paragraphs.

Bremen GT8N. The city of Bremen, Germany, has ordered 61, eight-axle LF-LRVs from AEG (MAN), which are currently being delivered (Figures 42 and 43). The vehicles are 35 m (115 ft) long and comprise four sections. Each section rides on a centrally located truck—which has four independently rotating wheels—although one pair is torsionally connected by the drive train that powers two of the wheels in each truck (Figure 44). The trucks have neither bolsters nor axles, with

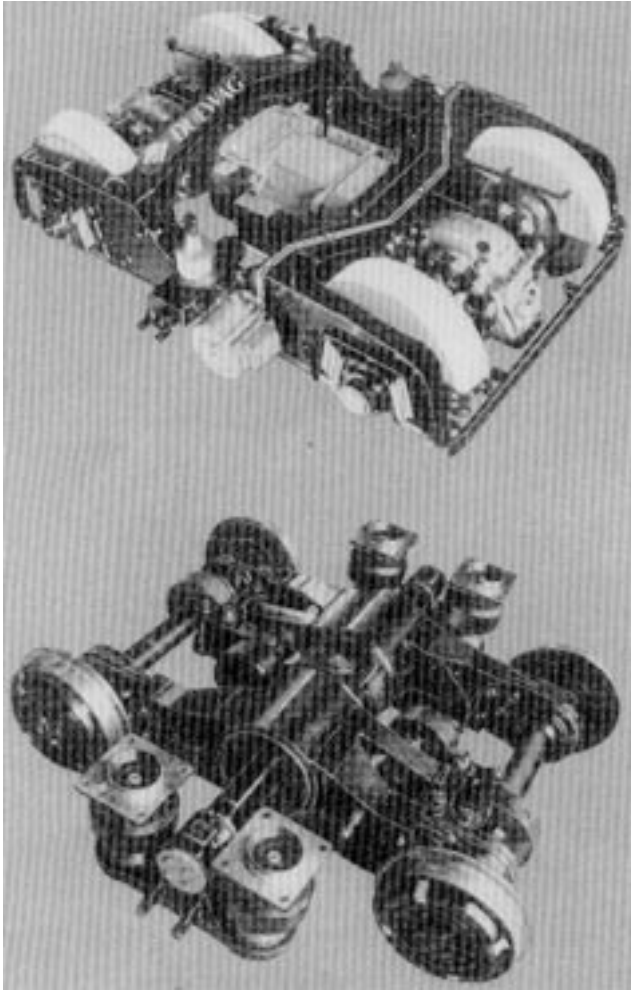


Figure 21. Geneva-type Be4/6 LF-LRV trucks.



Figure 22. Bern-type Be4/6 LF-LRV (photo).



Figure 23. Bern-type Be4/6 LF-LRV (interior view).

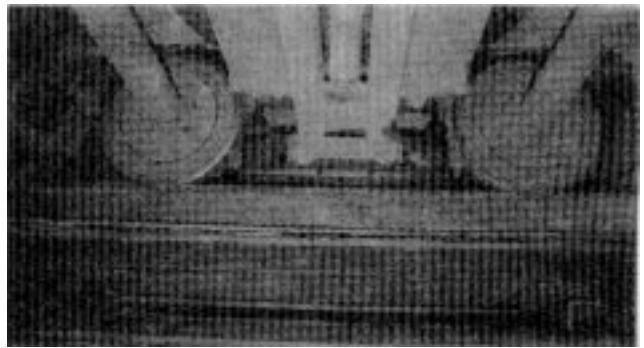


Figure 24. Bern-type Be4/8 LF-LRV (view of small wheels trailer truck).

the space between the wheels accommodating low-floor aisles. Although this is a 100 percent LF-LRV, the aisles may be too narrow to permit wheelchairs to pass from end to end.

The trucks have two-stage suspensions with air springs providing the secondary stage. Truck yaw relative to the carbody is enabled by the shearing flexibility of the air springs, but this has limits. It is not a constraint on ordinary curves down to 15-m (62-ft) minimum radius, because the truck swivel is small. However, the ability of this type of vehicle to negotiate short radius reverse curves needs careful analysis.

A single water-cooled AC traction motor, longitudinally and resiliently mounted below each carbody section, propels a pair of wheels on each truck via a cardan shaft, two gearboxes, and a cross-shaft (Figure 44).

A three-truck, three-section version designated GT6N, which is otherwise identical, has been ordered by eight German cities, including Munich. The total number of GT6N and GT8N currently in service or on order is 226, making this type the most popular Category-3 vehicle.



Figure 25. Grenoble/Rouen/Paris GEC-Alsthom LF-LRV (photo—view at station); (photo—view outside city).



Figure 27. Grenoble/Rouen/Paris GEC-Alsthom LF-LRV (photo—interior view).



Figure 26. Grenoble/Rouen/Paris GEC-Alsthom LF-LRV interface with station platform.



Figure 28. Grenoble/Rouen/Paris GEC-Alsthom LF-LRV trucks (photo).



Figure 29. Grenoble/Rouen/Paris GEC-Alsthom LF-LRV power and center truck (photo).

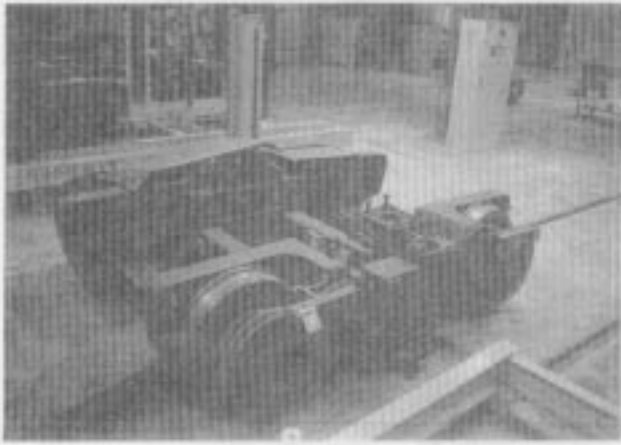


Figure 30. Grenoble/Rouen/Paris GEC-Alsthom LF-LRV access to truck components from shop pit (photo).

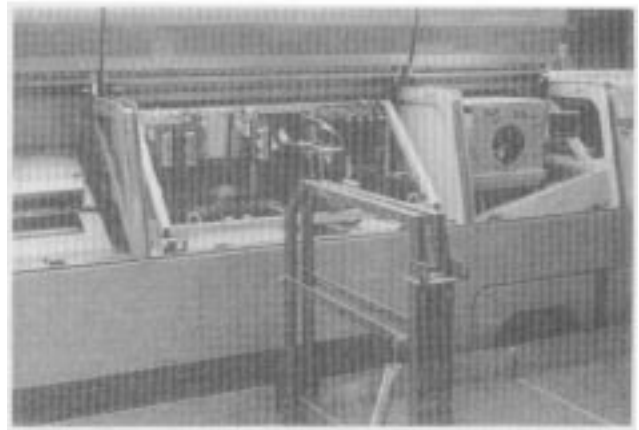


Figure 31. Grenoble/Rouen/Paris GEC-Alsthom LF-LRV access to truck components (photo).



Figure 32. Grenoble/Rouen/Paris GEC-Alsthom LF-LRV powered ramp (photo).



Figure 33. Kassel Transit Authority type NGT 6C (photo—at station).



Figure 34. Kassel Transit Authority type NGT 6C (photo—interior view).

Vienna Type ULF 197. The city of Vienna, Austria, has ordered 150 "ultra" LF-LRVs from a consortium of SGP Verkehrstechnik, Elin, and Siemens of Austria. The prototype is shown in Figure 45. The vehicles are designed on a modular basis and do not use conventional trucks but locate the drive and wheel guidance equipment in the sidewalls of the vehicle articulation (Figure 46). Each independent wheelset is driven by a vertically mounted, water-cooled AC motor on each side of the articulation. This unique design concept has been called Ultra Low Floor because it provides 100 percent low-floor area at a height of 197 mm (7.8 in), with entrance thresholds at 152 mm (6 in) above TOR.

The advantage of this extremely low-floor vehicle is its easier access from street level. However, there is risk inherent in the extremely innovative technology, which includes

- An active motor torque control to electrically couple the independently rotating wheels, for guidance on straight track;
- A system of linkages connecting the articulation portals for steering on curved track; and
- A pendulum suspension with hydraulic leveling.



Figure 35. Kassel Transit Authority type NGT 6C (photo—doors open at station).

Variotram. The Variotram (Figures 47 and 48), manufactured by ABB (Henschel-Waggon Union) has just entered service in the city of Chemnitz, which has ordered 53 of these 100 percent LF-LRVs. It has a low-floor level of 350 mm (13.8 in), with entrance thresholds at 290 mm (11.4 in) above TOR. Like many Category-3 LF-LRVs, the Variotram is a flexible modular concept intended to provide different capacities to suit any application. It can be produced in lengths from 20 m (66 ft) to 60 m (200 ft); widths of 2.3 m (7.5 ft) to 2.65 m (8.7 ft); with either meter gauge or standard (4 ft 8.5 in) gauge trucks, which can all be powered if required; and with air conditioning.

The Variotram has also been engineered to fit within approximately the same dynamic envelope as PCC cars and can negotiate horizontal curves down to 16 m (52.6 ft) radius. The Variotram's powered trucks are propelled by four water-cooled AC hub motors, directly driving each of the independently rotating wheels. The advantages and disadvantages of this direct drive are discussed later in this chapter.

Duewag has manufactured 20 LF-LRVs of similar design, the R3.1 for Frankfurt, which has a truck in the middle of each of three carbody sections (Figure 49).



Figure 36. Kassel Transit Authority type NGT 6C (photo—fare collection).

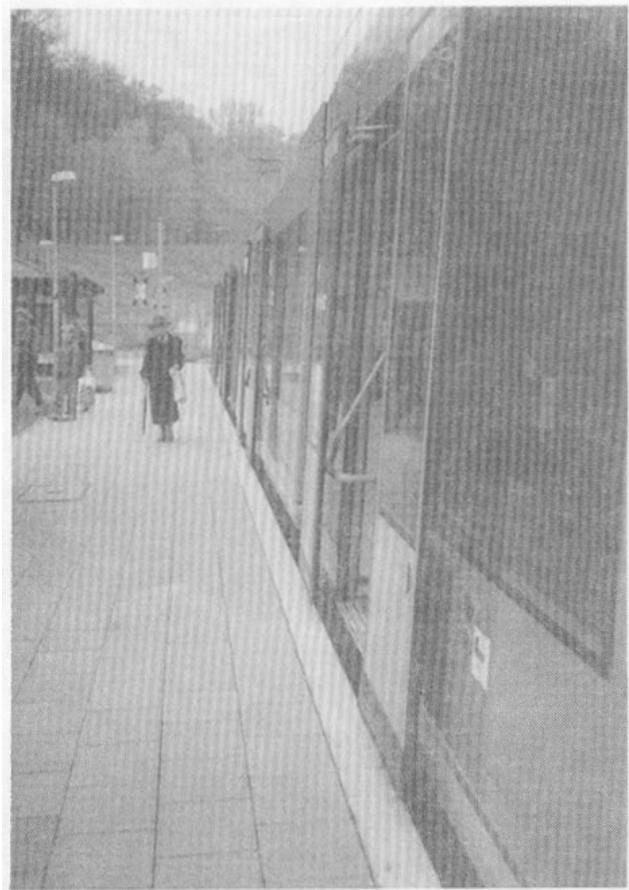


Figure 37. Kassel Transit Authority type NGT 6C (photo—at station).

Eurotram. The Eurotram (Figures 50 and 51) is assembled by ABB Transportation, Ltd., in the U.K., with ABB Trazione SPA in Italy supplying various parts. It was derived from the Socimi prototypes (see Chapter 1) and 26 of these 100 percent LF-LRVs have been ordered by Strasbourg for delivery in 1994. Eurotram is another flexible modular concept. For example, the Strasbourg vehicle is assembled as follows:

- two each, 2,575-mm (8.4-ft) long cab modules at each end;
- three each, 7,550-mm (24.8-ft) long passenger compartments; and
- two each, 2,350-mm (7.7-ft) long articulation sections between the passenger compartments.

The total length is 33.1 m (108.6 ft). The Eurotram is designed to interface with 240-mm (9.5-in) high platforms, with a 110-mm (4.3-in) step up to its 350-mm (13.8-in) low-floor level. The center doors are equipped with powered wheelchair ramps.

The Eurotram has large side windows and a huge compound

curved windshield. All roof-mounted equipment is covered by glass reinforced plastic (GRP) panels to maintain a sleek appearance. The carbody frame is made of welded aluminum extrusions covered with removable GRP panels.

The Eurotram's motored and trailer trucks have four independently rotating wheels mounted on a rigid frame truck. The motored wheels are driven by water-cooled, truck frame-mounted, AC squirrel cage motors via parallel drive gearboxes. The truck features air spring secondary and radial arm wheel suspension, using rubber primary springs. The design permits a small wheel base, which the manufacturer claims has good curving characteristics.

VLC. The VLC (Figure 52) manufactured by Breda in Italy, is another modular concept vehicle. However, it is not strictly a 100 percent low-floor vehicle. The end modules ride on a compact, but unconventional monomotor truck, and have a high-floor cab and electric locker compartments 950 mm (37.4 in) above TOR. The passenger compartment floor is continuous at a low level of 350 mm (13.8 in) above TOR. The city of Lille, France, has ordered 24 four-module, triple-articulated, 29.9-m (98.1-ft) long vehicles of this type. The low floor in the Lille configuration comprises 80 percent of the total length.

The powered trucks are unique. Each is driven by a single,



Figure 38. Kassel Transit Authority type NGT 6C LF-LRV with EEF wheelsets manufactured by BSI.

transversely mounted, AC asynchronous monomotor driving two conventional wheel-axle assemblies (Figure 53). The single wheelset trailer running gear (Figure 54) supports each articulation section and comprises two independently rotating wheels that are set tangential to the rail on curved track. The trailer running gear is effectively steered by the articulation and, together with the very short wheel base of the power trucks, gives good curving ability down to a minimum horizontal radius of 25 m (82 ft).

The welded aluminum framed carbody is covered by bolted aluminum side panel extrusions. The ends are made of structural composite material. The structure is capable of withstanding an unusually high buff load (for a European LRV) of 50 tonnes (110,000 lb).

NEW TECHNOLOGY DESCRIPTION AND ASSESSMENT

Low-floor areas in excess of 48 percent have been achieved in Category-2 and Category-3 vehicles by using innovative running gear based on either small wheels or independently rotating wheels. The state of the art has advanced to a point where independently rotating wheels can be motored and/or arranged to be self-steering or forced steered by a variety of methods.

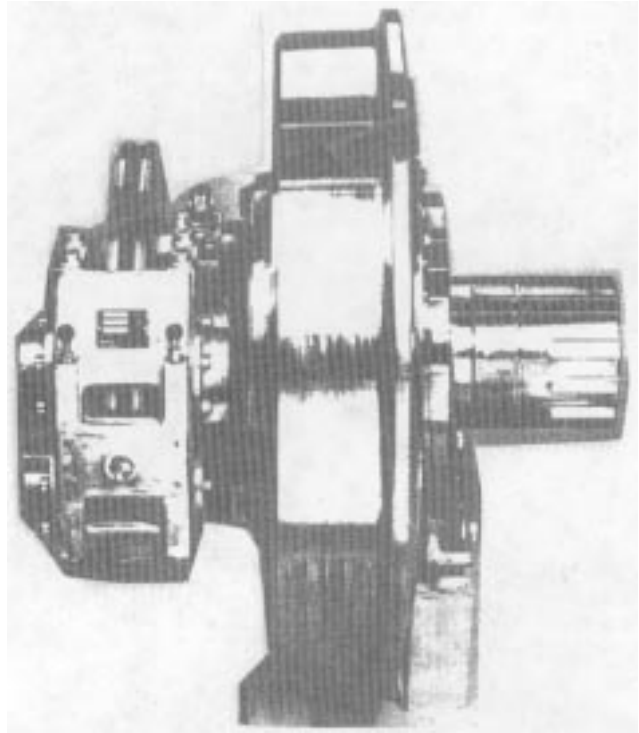


Figure 39. Kassel Transit Authority type NGT 6C LF-LRV with EEF wheelsets and resilient wheels.

This section briefly describes and assesses the different running gear designs and constructions currently being used in Category-2 and Category-3 vehicles, with particular emphasis on wheelsets and guidance; propulsion, motors, and gearboxes; suspensions; ramps and lifts; and carbody construction and materials.

Since most of this technology is in its infancy, the research found limited, objective reliability and maintainability records that could be used to quantify operating costs. Anecdotal information is cited, when available; otherwise, the assessment is based on fundamental principles.

Small Wheels

The simplest way to achieve a low floor is to reduce the wheel diameter and thereby lower the height of the straight axle that connects the wheels. The advantages of this approach include the following:

- The self-steering characteristics of the conventional wheelset are maintained. It can be shown theoretically that the centering action is more powerful. (7)
- Unsprung mass, which determines the vertical wheel/rail interaction dynamic forces, is dramatically reduced; thereby significantly decreasing the vibrations and shocks experienced by both running gear and rail.
- Small wheelsets are cheaper.
- A mini-conventional trailer truck can be made (Figure

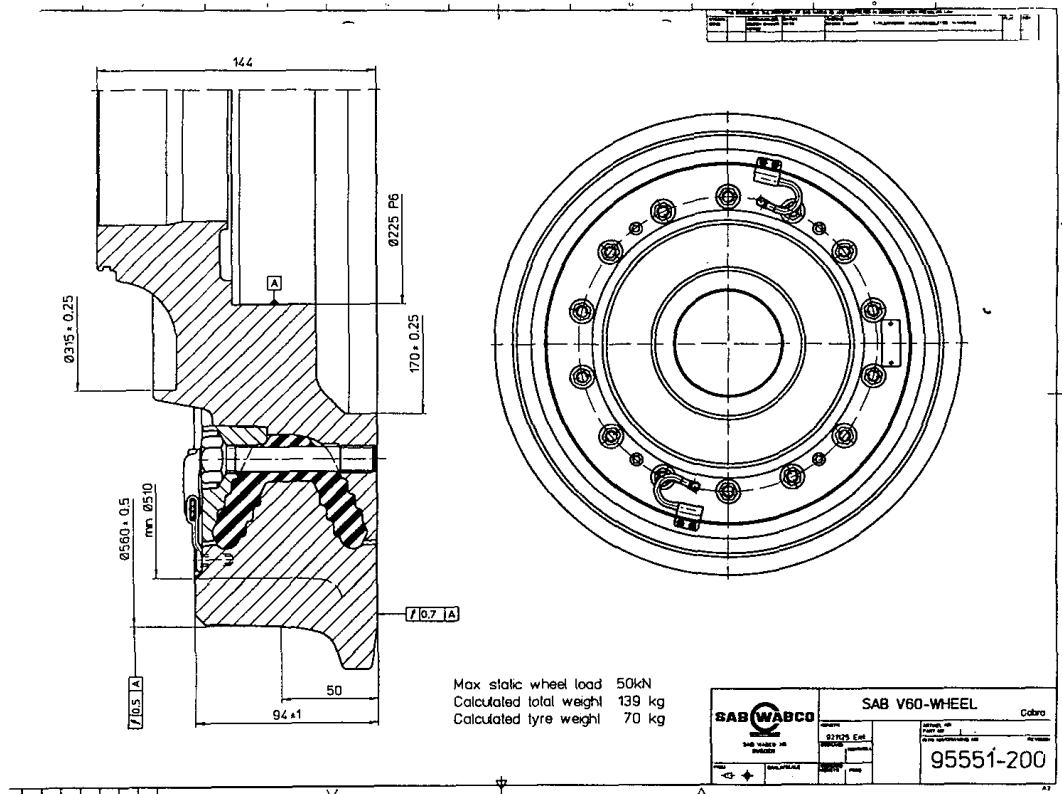
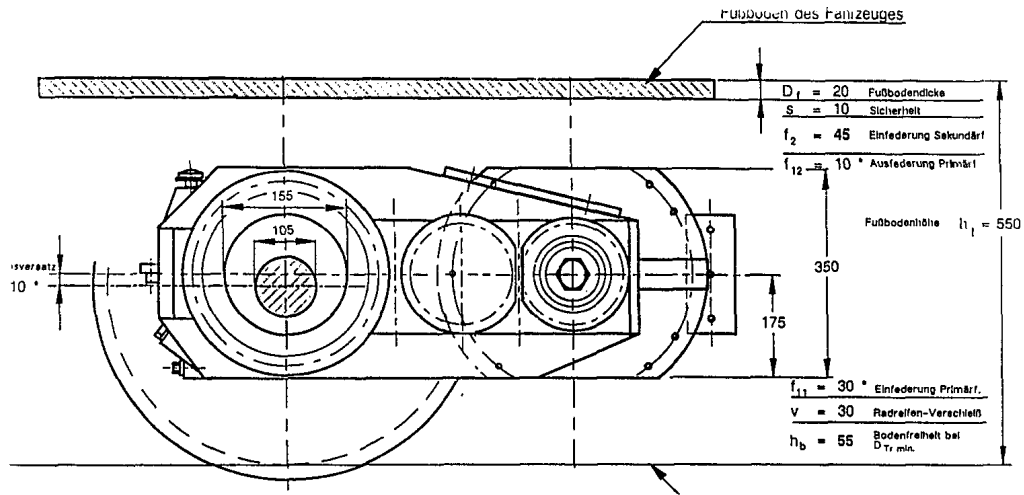


Figure 40. Kassel Transit Authority type NGT 6C LF-LRV with EEF wheelsets and resilient wheels.



LOW PROFILE POWER TRUCK- BOCHUM SOLUTION-

Car floor height, new 550 mm (21.65 inches)
 Wheel dia. new/worn 560/500 mm (22/20 inches)
 Fully suspended motor/gear/disc brake

Figure 41. City of Bochum type NGT 6C LF-LRV with bimotor truck.



Figure 42. Bremen GT8N LF-LRV from AEG (MAN)—photo at station.



Figure 43. Bremen GT8N LF-LRV from AEG (MAN)—photo.

55) with both primary and secondary suspensions, similar to conventional trucks.

In addition, theoretical analysis done by Vevey (8), the principal exponent of this technology, demonstrates that small wheels have the same or slightly less risk of derailment than conventional wheels.

The main concern with small wheels was perceived to be reduced wear life (and therefore increased maintenance costs) as a result of

- Higher contact stresses;
- A greater number of revolutions turned in a given distance; and
- The small radial material depth available for wear and truing to correct flat spots and other tread damage.

In practice, however, the wear rates have not been significantly different from those obtained with standard wheels:

- Vevey reports (9) 4-mm (5/32-in) radial wear after 83,000 km (52,000 miles) running in Bern.
- Re-profiling of small wheels is done at intervals of 100,000 km (62,500 miles) in Geneva and 120,000 km (75,000 miles) in Bern.
- Wheel replacement is reported (9) to be required after 250,000 km (156,000 miles) in Bern, and 120,000 km (75,000 miles) in Geneva; however, Vevey indicates that machining techniques are likely responsible for the latter.

Furthermore, it can be argued that

- The increased static contact stress experienced by small wheels is offset by the reduced dynamic wheel/rail forces.
- The smaller wheel base of the trucks and the somewhat more powerful steering action of the smaller wheels, should reduce flange contact and lateral slip during curve negotiation.
- The composition of the steel used in the wheels can be adjusted to improve wear properties, further mitigating the effect of higher contact stress. Vevey has done this with evidently satisfactory results.
- Optimizing the longitudinal primary suspension and using wheel flange lubricators can further improve curve negotiation behavior.

Therefore, it appears that the use of small wheels on trailer trucks or on single-axle trailers should give satisfactory operation. Maintenance costs should be lower than conventional trailer trucks because, as Figures 56 and 57 demonstrate, the removal and replacement of the small wheelset is easy to accomplish by lifting the carbody 560 mm (22 in). The wheelset can then be removed for machining on an ordinary lathe in approximately 20 min.

Small wheels that are driven have not been used on any low-floor vehicle. They are too small for the hub motor, and propulsion via a gearbox does not appear to be feasible.

Independently Rotating Four-Wheel Trailer Trucks

The best known vehicle that uses this type of trailer truck is the Grenoble Car. On this vehicle, the independently rotating wheels are mounted on a cranked axle, which provides the following advantages:

- Accurately fixes the back-to-back dimension of the wheels;
- Allows the use of a primary suspension between the cranked axle and the truck frame, similar to conventional trucks; and
- Maintains the left wheel parallel to the right wheel—if one wheel runs tangent to the rail, so will its mate.

On other types of vehicles that use independently rotating wheels—for example the Fiat (Firema) LF-LRV in Turin—the wheels are mounted directly to the truck frame. On other types of vehicles (e.g., the Eurotram), a stub axle is used. In

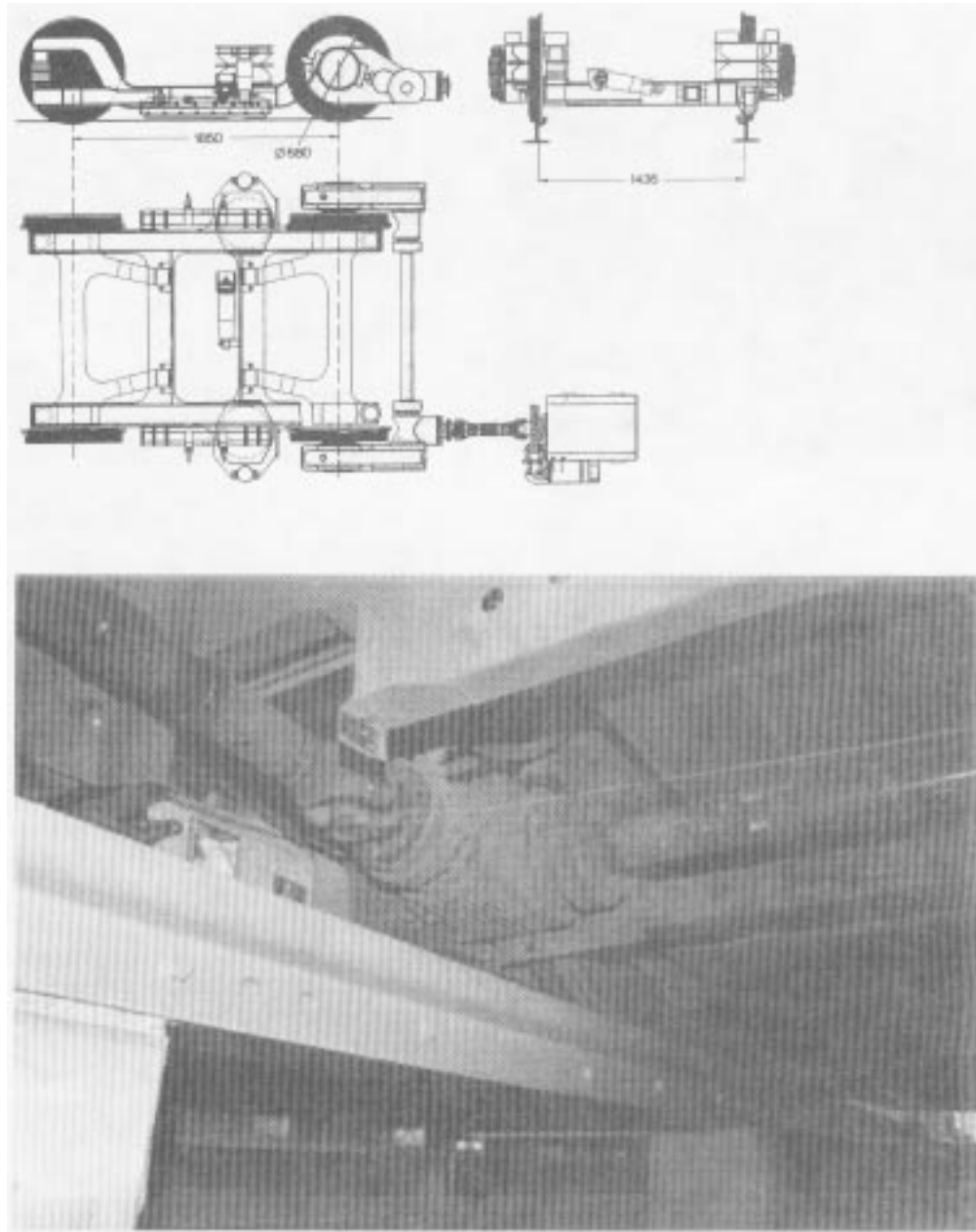


Figure 44. Bremen GT8N LF-LRV from AEG (MAN) truck and wheels.

all cases, a bearing is required in the wheel hub or the truck frame to permit the wheel to rotate freely.

If the treads of the four independently rotating wheels are curved or sharply profiled (such that the diameter increases towards the wheel flange) and they are maintained in good alignment, they will provide a small restoring moment to center the truck on straight track—as conventional wheels do. The wheels generally run on an angle of attack to the rail in curves, which designers attempt to minimize by reducing the truck wheel base as much as possible. The angle of attack causes the wheel to slip laterally across the rail, which generates lateral forces that are greater than in conventional (coupled) wheelsets, thereby exacerbating wheel and rail wear.

Another disadvantage of independently rotating wheels is that there is no possibility for tractive effort-sharing between the left and right wheels. Independently rotating wheels are more prone to spin when driven and slide when braked because of the high variability in adhesion, which is "averaged" in conventional coupled wheels by the axle that connects them. Therefore, it is essential to equip vehicles that use independently rotating wheels with efficient, quick-response, spin-slide controls.

The use of independently rotating wheels on the Grenoble Car since 1987 has been satisfactory (5), with a reported (7) wheel life of 250,000 km (156,000 miles). Since this type of truck retains most of the advantages of conventional trailer



Figure 45. Vienna type ULF 197 prototype LF-LRV.



Figure 47. Variotram LF-LRV manufactured by ABB (Henschel-Waggon Union)—at station.



Figure 46. Vienna type ULF 197 LF-LRV power portal.

trucks (with two conventional wheelsets), it will continue to be used in both Category-2 and Category-3 vehicles for the foreseeable future.

Force-Steered Single-Axle (Conventional Wheelset) Trailer Trucks

The force-steered single-axle trailer truck concept is shown in Figure 58. It consists of a single, conventional wheelset that

is assembled from two, 590-mm (23.2-in) diameter profiled wheels, press-fitted on a solid straight axle with outboard axle bearings and brake discs. In addition, it has the following characteristics:

- A hollow-section, welded-steel truck frame;
- Chevron primary suspension;
- Coil-spring secondary suspension; and
- A steering linkage that connects the truck frame to the adjacent floating articulation and causes the axle to adopt a radial alignment on curved track.

The Bombardier (Rotax)-Duewag, Type T, LF-LRV uses this approach. Beginning in 1993/1994, 68 vehicles were delivered and are now operating on the Vienna U-Bahn. Bombardier states (10) that the pressure to produce this vehicle in a short time, without the benefit of extensive operational testing, is the reason they chose the force-steered single-axle trailer truck concept instead of the self-steering independently rotating wheel technology. Service experience with the Type T has been satisfactory, but the cars have not been in service for very long. Therefore, it is not possible to evaluate long-term performance. The steered axle concept is derived from the Talgo intercity train, which originated in Spain and has had a successful inservice history. The very limited application of this concept to date suggests that it may be a "custom" design, unlikely to find widespread use elsewhere.

Self-Steering (EEF) Wheelsets

The principle behind the EEF wheelset has been well-documented (5), (7), (11) and is shown in Figure 59. The independently rotating wheels of this wheelset are allowed to rotate around a vertical axis that is located outboard of the wheel. The wheel tread is tapered or profiled; therefore, the normal

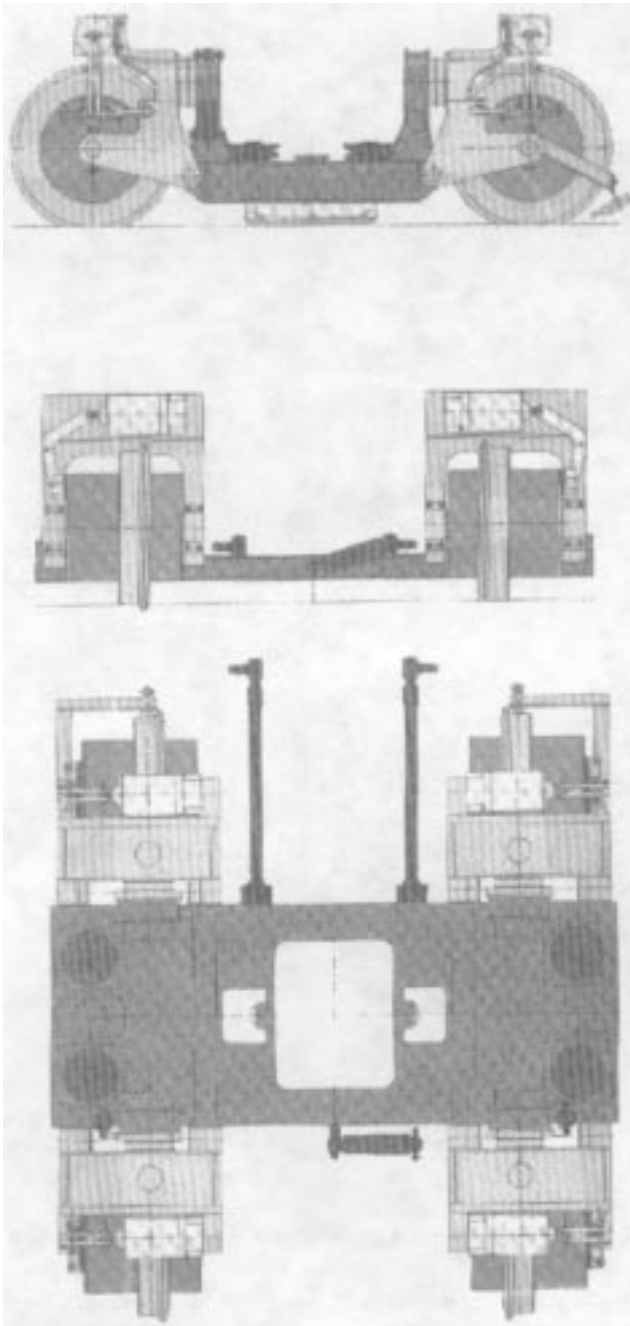


Figure 48. Variotram LF-LRV manufactured by ABB (Henschel-Waggon Union)—running gear and hub motors.

force at the point of wheel/rail contact is inclined with a horizontal component that always acts in the direction of the track centerline. If the wheel develops an angle of attack with the rail, the horizontal force component provides a couple around the vertical axis of rotation to restore the wheel to run tangentially to the rail.

The complete EEF wheelset assembly (Figure 60) comprises the following:

- Two independently rotating, resilient wheels with integral disc brakes and calipers (Figure 61),

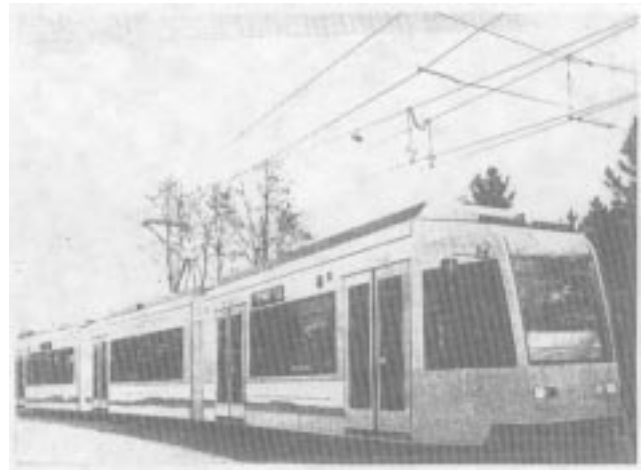


Figure 49. Frankfurt R3.1 LF-LRV manufactured by Duewag.



Figure 50. Eurotram LF-LRV assembled by ABB (U.K./Italy).

- A type of cranked axle (Figure 62),
- A truck frame,
- Rubber primary suspension,
- Four coil springs for the secondary suspension, and
- A steering linkage that interconnects the two wheels so they steer in unison.

The principle was thoroughly tested on the VDV Stadtbahn prototypes and first used in revenue service in 1990 on the Duewag vehicles for Kassel. Since then, nine other Category-2 Duewag LF-LRVs (for Bochum, Heidelberg, Rostock, Bonn, Halle, Brandenburg, Mulheim, Dusseldorf, and Erfurt) have used EEF trailer wheelsets—a total of 165 vehicles.

EEF wheelsets have performed adequately on the Kassel cars after some initial problems. However, like all independently rotating wheel running gear, quick-response slide controls are needed to avoid formation of wheel flats during braking. In

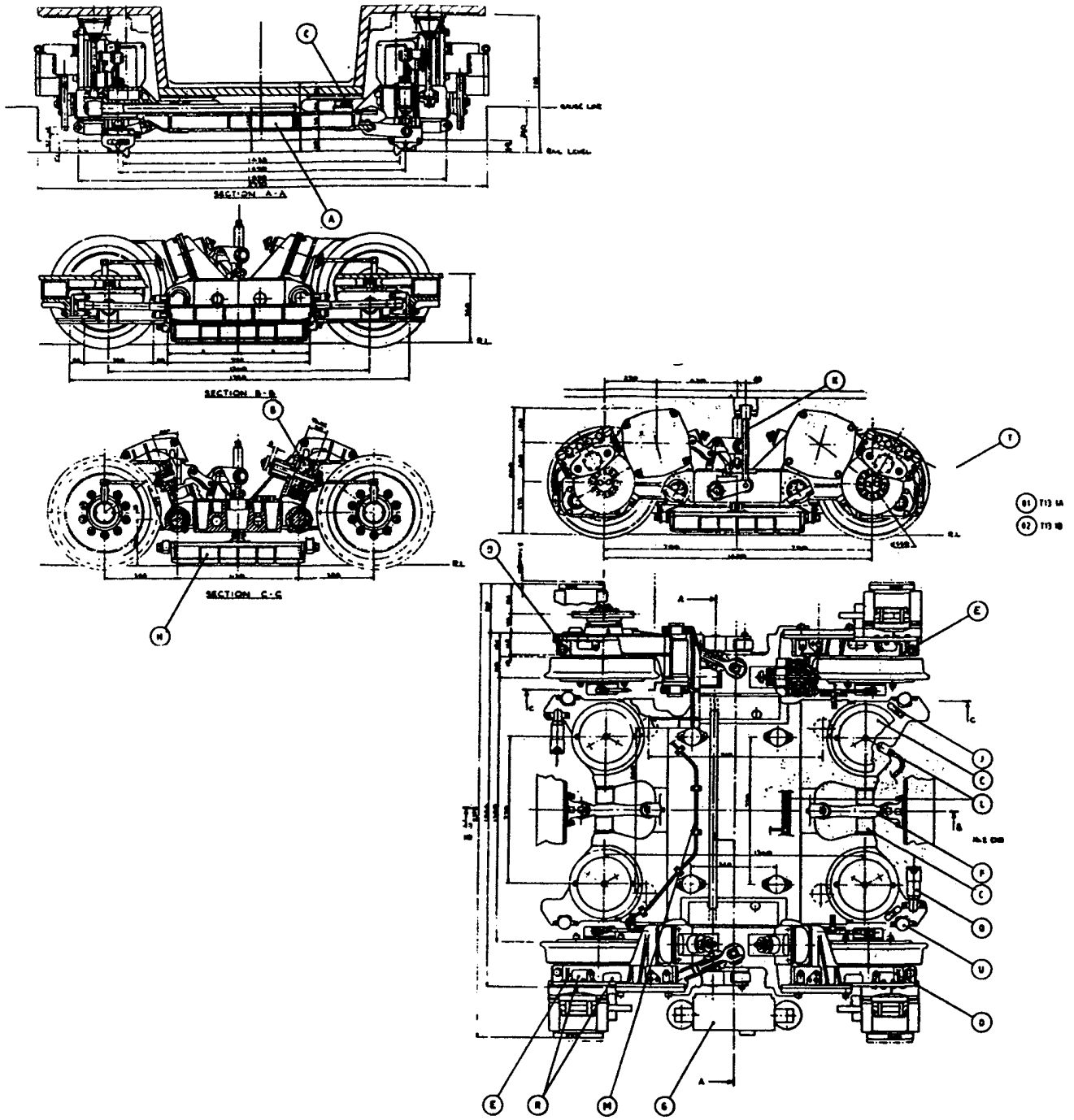


Figure 51. Eurotram LF-LRV assembled by ABB (U.K./Italy)—schematic.



Figure 52. VLC LF-LRV manufactured by Breda (photo—on street).

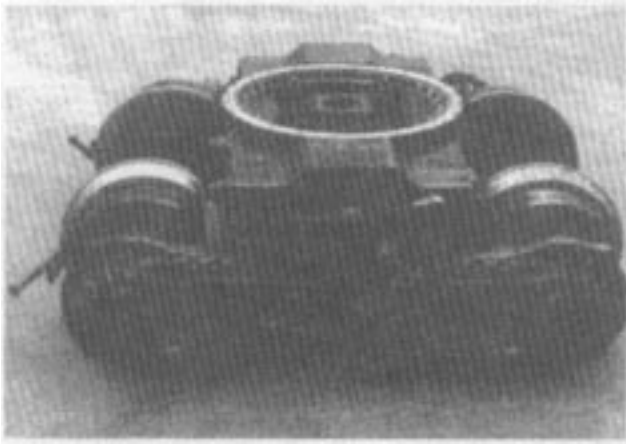


Figure 53. VLC LF-LRV wheel-axle assemblies.

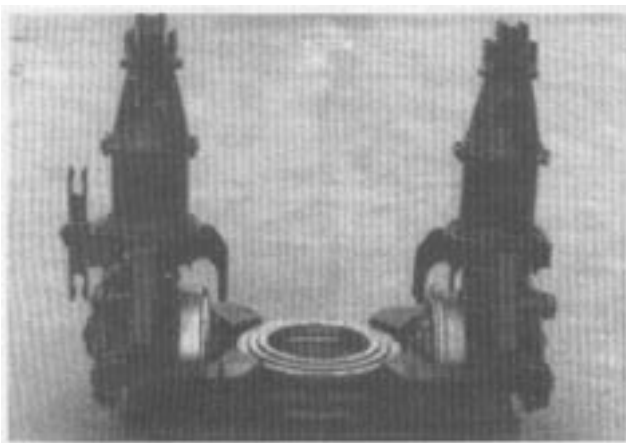


Figure 54. VLC LF-LRV single wheelset trailer running gear.

addition, the maximum speed for vehicles using this technology is currently 70 km/h (44 mph).

The self-guiding principle only works in practice if the wheel develops a substantial angle of attack—otherwise the restoring moment is insufficient to overcome the friction in the pivot bearing. For best results, the nominally vertical axis around which the wheel steers should be slightly inclined in the direction of travel (7). This can work on unidirectional vehicles but cannot be done on bidirectional vehicles.

In addition, since the wheelset assembly must be manufactured to very precise tolerances, it will probably continue to be expensive to produce. It is anticipated that EEF trailer wheelsets will undergo considerable refinement during future in-service experience. North American application will probably be limited to low-speed operations.

As noted in Chapter 1, the VDV Stadtbahn prototype program failed to produce a satisfactory motored EEF wheelset. Therefore, EEF technology should currently only be considered practical in trailer running gear applications.

Articulation-Steered Independently Rotating Wheelsets

The articulation-steered, independently rotating wheelset approach has been used in two vehicles—the Breda VLC for Lille and the SGP ULF 197 prototype for Vienna. In both vehicles (12, 13), the two independently rotating wheels support, and are part of, the articulation joint. A system of linkages is used to ensure that the articulation portal splits the angle between adjacent carbodies when the entire vehicle is on a curve. The wheelset turns with the portal and lies on a radius to the curve, thus making the wheels tangential to the rail.

The ULF 197 vehicles operating in Vienna use a system of linkages that interconnect each articulation portal to the one in front and behind (Figure 63). This mechanism is intended to improve steering during curve entry and exit—the leading wheelset follows the rails by wheel flange contact and turns the trailing wheelsets via the linkages.

This type of forced steering works well on curved track and enables the vehicles to negotiate small radius curves quietly and with less wear. However, it does not help guidance on tangent track. The Breda VLC relies on flange guidance on straight alignments. The ULF 197 vehicle can actively control the torque of the motors driving the wheels to "electrically couple" them, thereby simulating a conventional wheelset axle. This state-of-the-art guidance technology is still in its infancy and therefore difficult to assess. Vienna's order for 150 ULF 197 vehicles is reported (6) to be contingent on satisfactory performance of the prototypes.

It should again be noted that the articulation-steered running gear has only been used on the VLC and ULF197 vehicles, which are basically trams intended for city street operation where maximum speeds of 70 km/h (44 mph) are sufficient. This form of running gear may not be stable for operation at higher speeds.

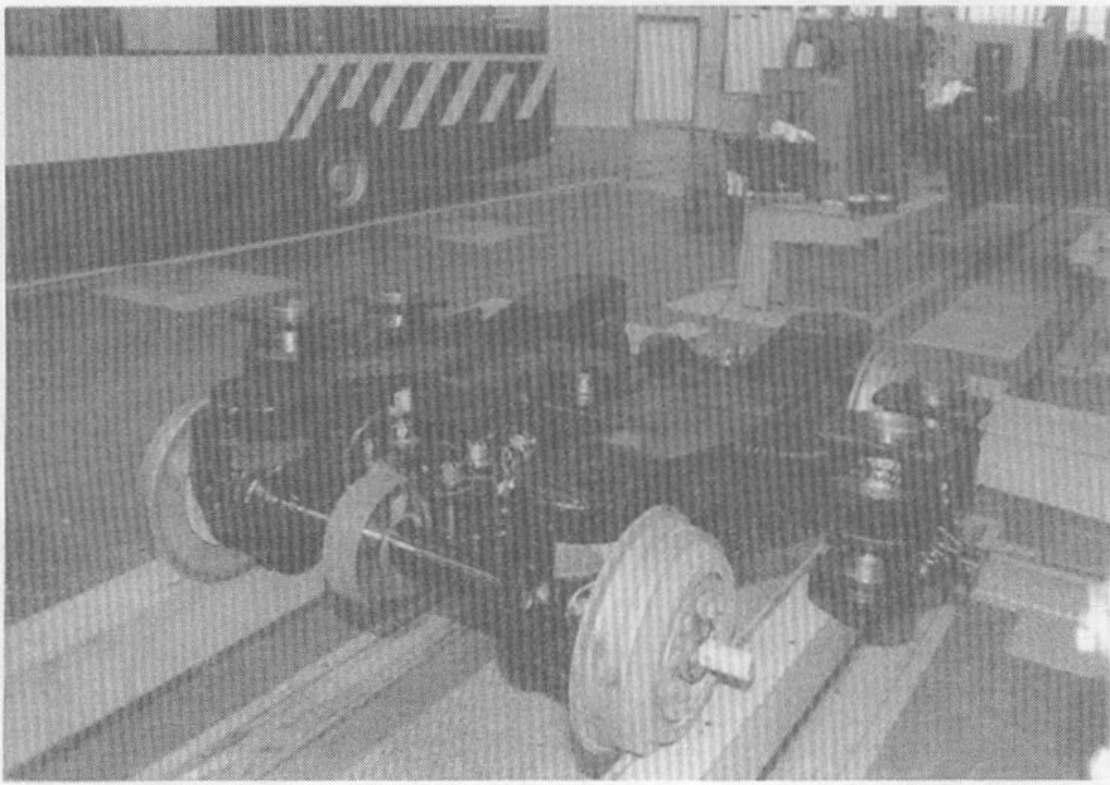


Figure 55. Mini conventional trailer truck.

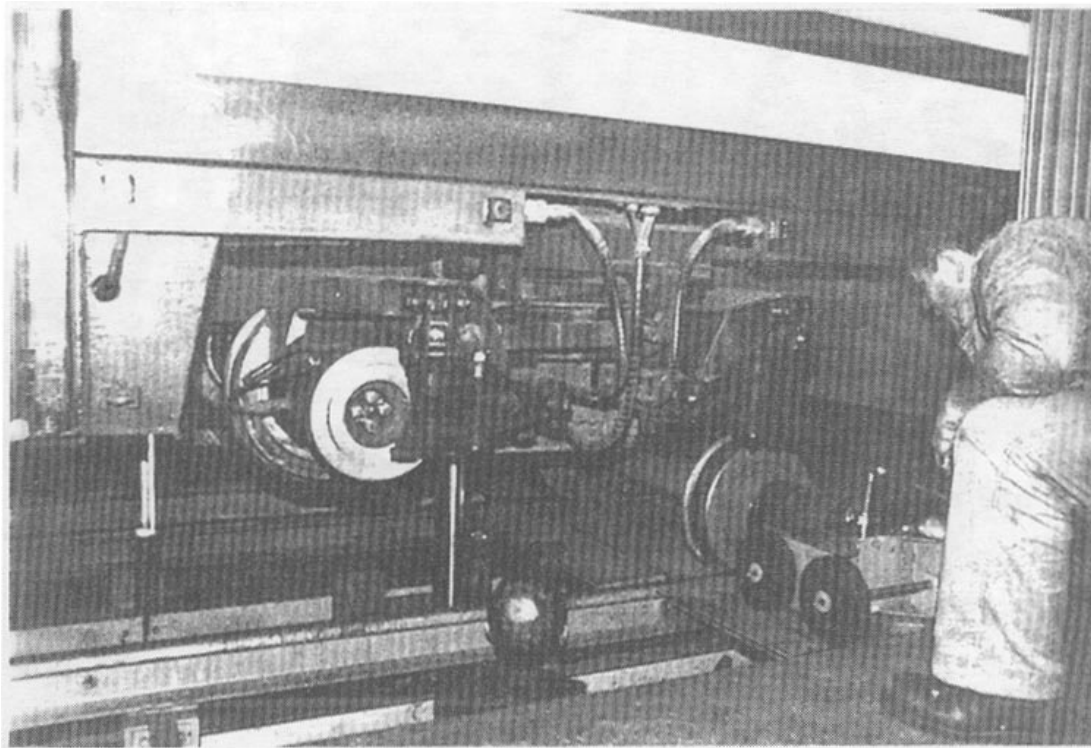


Figure 56. Removal and replacement of small wheelsets (photo).

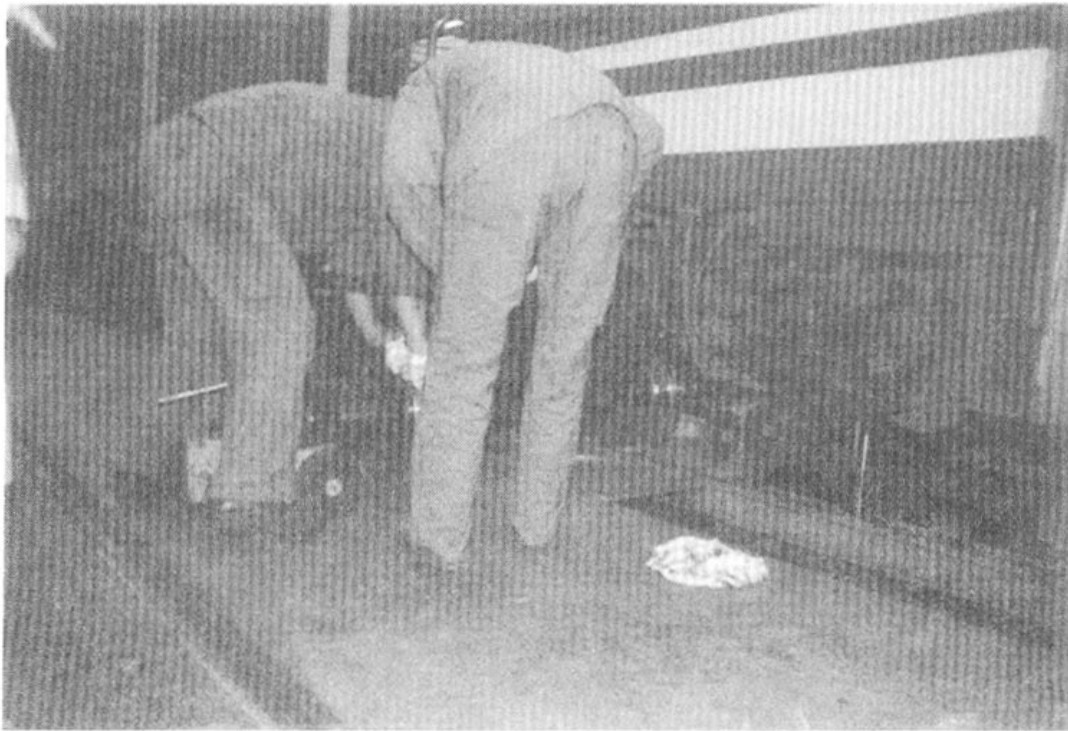


Figure 57. Removal and replacement of small wheelsets (photo).

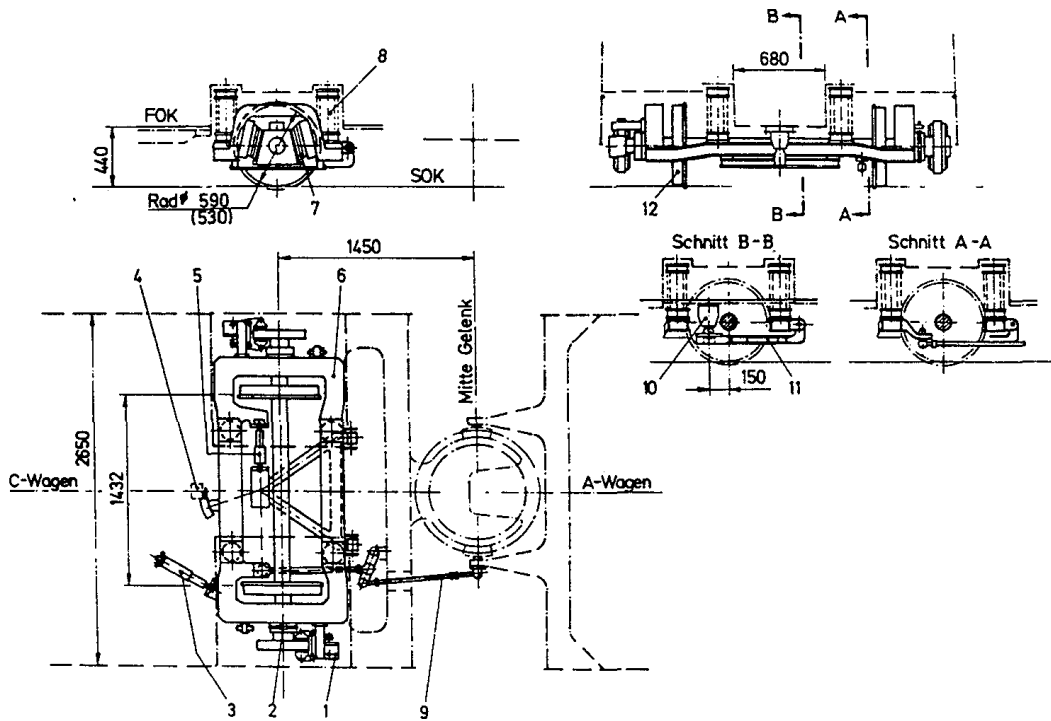


Figure 58. Forced-steered single-axle trailer truck concept (schematic).

EEF Principle—Self-steering of the wheel through lateral forces developed by the profile F_y

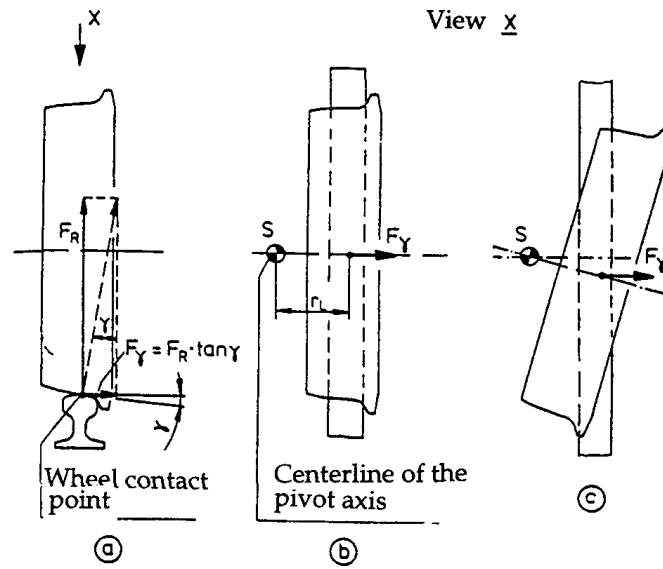


Figure 59. Self-centering EEF wheelset design principle (schematic).

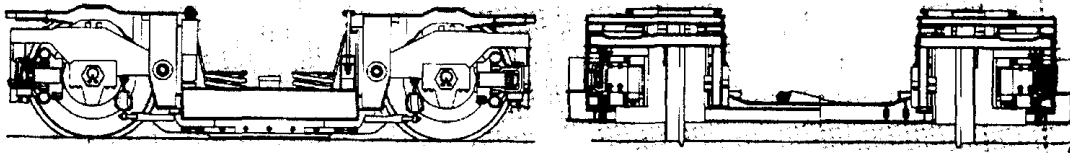


Figure 60. Complete EEF wheelset assembly.

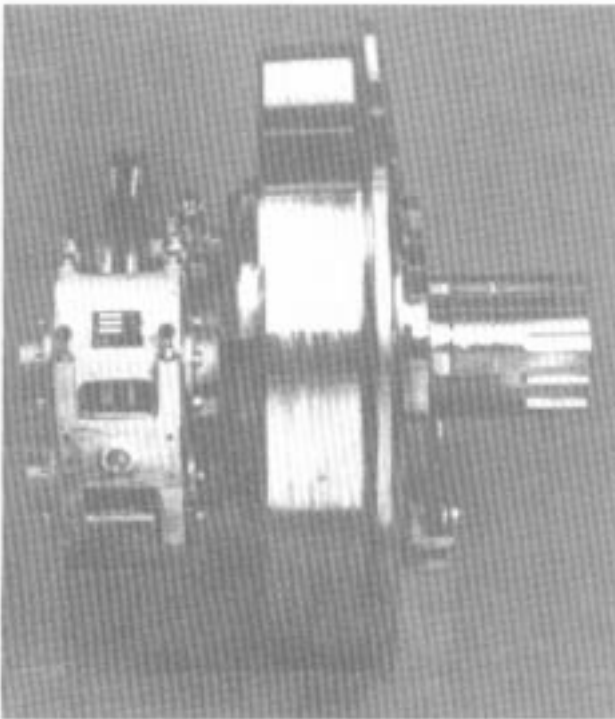
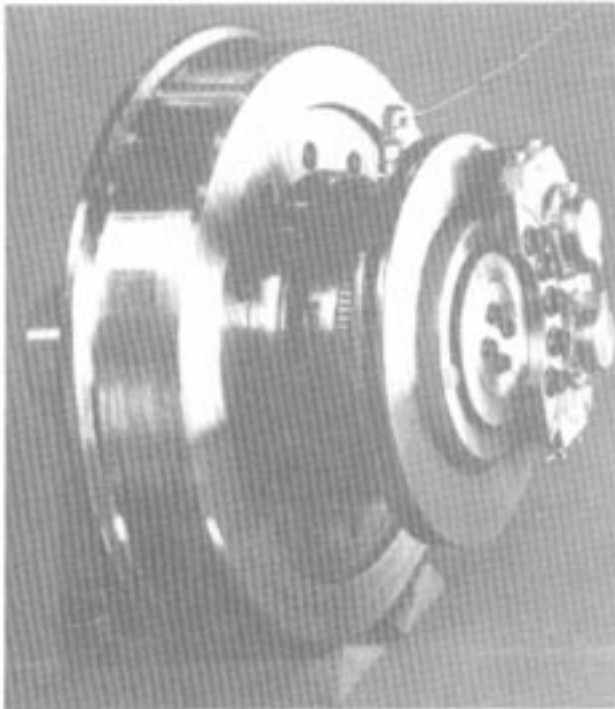


Figure 61. BSI independent wheel (for Kassel).

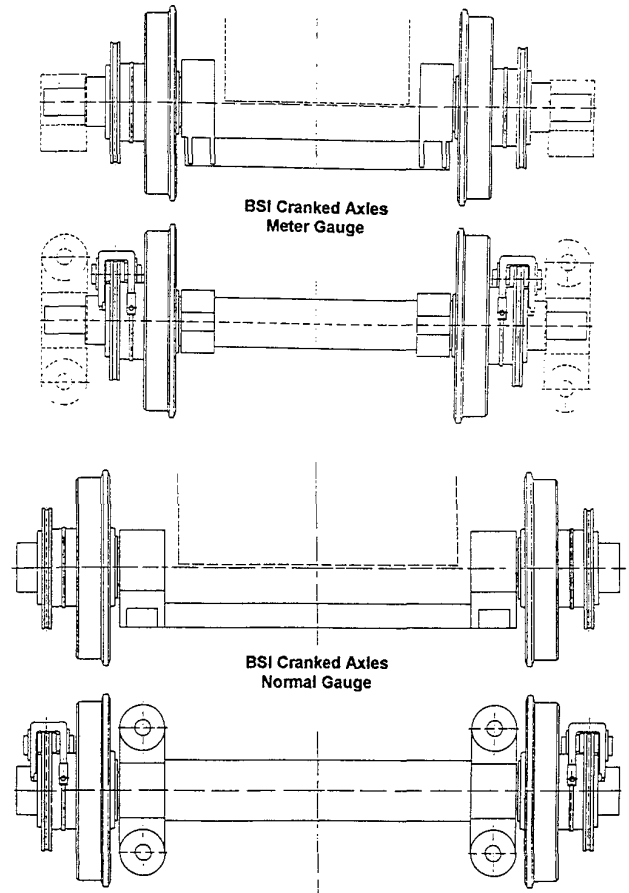


Figure 62. BSI cranked axle (schematic).

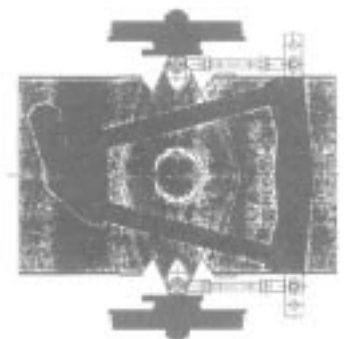
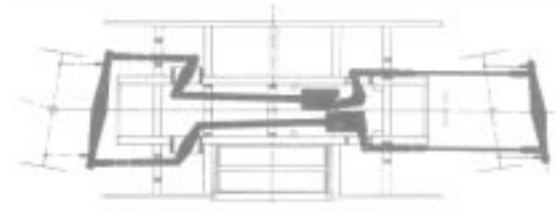


Figure 63. ULF 197 steering linkages interconnecting articulation portals.



Figure 64. Running gear used on Bombardier (BN) Tram 2000.



Figure 65. Tram 2000 wheels.

Rail-Steered Articulated Trucks

The final example of a state-of-the-art running gear is rail-steered articulated trucks (Figures 64 and 65). Brussels ordered 51 Bombardier (BN) Tram 2000s with this type of running gear.

The running gear consists of two very small, 375-mm (14.8-in) diameter rollers that follow the rails. Through a complex system of linkages and an articulating frame, these rollers steer the standard size, independently rotating (hub motor-driven) load-carrying wheels. One truck is located at each end of the vehicle, with the large driven-wheels in the lead. Accordingly, the trucks are suitable for use on unidirectional vehicles only. This arrangement was tested extensively on a roller rig, and for one year in Amsterdam.

The vehicle's ride quality was judged excellent based on a subjective evaluation during this project. The vehicle has entered service, and its manufacturer is pleased with the reliability obtained from the running gear (21). If this reliability is sustained, the running gear of Tram 2000 should save on track maintenance cost because of its excellent curving ability. It is again noted, however, that the maximum speed of Tram

2000 is stated as 70 km/h (44 mph). It is not known whether its running gear will be dynamically stable at higher speeds.

Motors and Gearboxes

Design and construction of 100 percent LF-LRVs has been accomplished by using new and innovative drive arrangements to propel the independently rotating wheels, which are intrinsic in the running gear of most Category-3 vehicles. Since space under these 100 percent LF-LRVs is limited, motors and gear-boxes must also be compact—thus requiring the use of three-phase AC traction motors controlled by variable frequency inverters. This form of propulsion is possible because of the development of cheap and reliable power electronics, most notably insulated gate bipolar (IGB) transistors.

Several drive configurations exist—each specifically designed for a particular running gear arrangement. These various drive configurations are described in detail in Figure 66. These designs are very new; therefore, their longevity is difficult to assess.

The AEG (MAN) GT6N/GT8N uses a fully sprung motor, mounted below the carbody, which is isolated by both primary and pneumatic secondary suspensions. On the other hand, hub motor drives, because they increase unsprung mass, are considered a higher risk—particularly when the wheel is not resilient (such as in the Variotram). This increases the shock and vibration experienced by the running gear, motor, and gearboxes, as well as the rail.

In addition, all of these drive configurations are used in vehicles intended to operate on city streets where the maximum speed is limited to 70 km/h (44 mph). It is not known whether the thermal capacity of the water-cooled motor is sufficient for interurban duty cycles typical in North American LRT systems.

Suspensions

After experimenting with prototypes that had only one-stage suspensions, most manufacturers of all three categories of LF-LRVs have reverted to building the running gear with both primary and secondary suspensions.

Rubber primary suspension springs are used on most vehicles. On two of the Category-3 vehicles (the ABB [Socimi] Eurotram and the ABB [Henschel] Variotram), the trucks have a "radial-arm" primary suspension. In these vehicles, the wheel bearing pivots around the truck frame and the primary spring is either horizontal (Variotram) or inclined (Eurotram).

Two vehicles, the Breda VLC and the SGP ULF 197, do not have primary springs. Both vehicles have single wheelsets with independently rotating wheels that support the articulation portal frames, but the wheels are resilient (as are the majority of Category-3 vehicle running gear wheels).

Most secondary suspensions are provided by air springs or coil springs. The advantage of air springs is that stiffness can be adjusted by leveling valves to maintain constant height and secondary-suspension natural frequency, regardless of passenger load. Two of the Category-3 vehicles that have coil spring

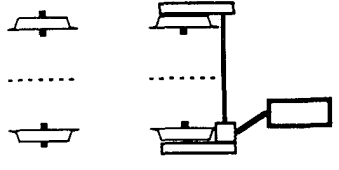
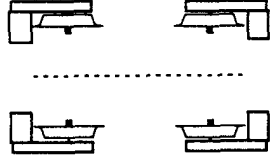
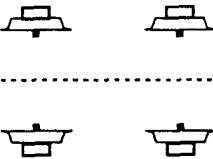
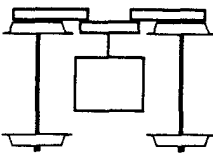
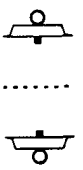
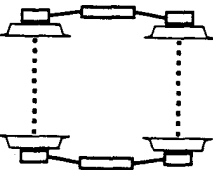
Configuration	Description	Application
	Longitudinal, 3-phase AC, air-cooled, motor suspended under each carbody section. Drives 2 of 4 independently rotating wheels via cardan shaft, right angle gear, cross shaft and two parallel spur gear boxes mounted outboard of each wheel.	All trucks of AEG (MAN) GT6N/GT8N; Augsburg, Bremen, Munich
	Each of 4 independently rotating wheels of the truck is driven by its own 3-phase asynchronous, water-cooled, truck frame-mounted motor, via a parallel gearbox	Power trucks of ABB Eurotram for Strasbourg
	Water-cooled, AC motor mounted in the hub of each independently rotating wheel and driving via an in-line planetary gear set housed in the motor casing or without any gears.	Duewag R3 1 for Frankfurt; ABB (Henschell) Variotram for Chemnitz; BN Tram 2000 for Brussels
	Transverse monomotor driving two conventional wheelsets via cardan shaft and two parallel gear boxes.	Power (end) trucks of Breda VLC for Lille
	Each independently rotating wheel of the wheelset is driven by a right angle gearbox and an asynchronous water-cooled motor, vertically-mounted inside the articulation portal.	SGP ULF 197 for Vienna
	One AC asynchronous traction motor, suspended from the carbody (underfloor), drives a pair of independently rotating wheels on one side, via a cardan shaft and right angle gearbox for each wheel.	Schindler COBRA prototype

Figure 66. New drive configurations for Category-3 LF-LRVs.

suspensions use hydraulic cylinders to provide passenger load weight compensation.

The most radical suspension is on the SGP ULF 197 vehicles operating in Vienna. The carbody sections are suspended from the articulation portals by pendulum links and coil springs.

Ramps and Lifts

Although Category-3 LF-LRVs have entrances as low as 152 mm (6 in) above TOR, some type of ramp or lift is needed to enable persons in wheelchairs to enter if there is no platform (i.e., boarding from street level). Some examples of ramps and lifts used on Category-2 and Category-3 vehicles include the following:

- Power ramps on the GEC Alstom cars (Category-2 vehicle) for Grenoble, Rouen, and Paris. When deployed, this ramp (shown previously in Figure 32) bridges the gap between the vehicle's low floor, which is 345 mm (13.6 in) above TOR, and the low-station platform.
- A 3.1 m (10.2 ft) sliding, extendable ramp used on the Duewag R3.1 in Frankfurt. This ramp can be deployed in under 2 min, which is comparable to the time it takes for a conventional wheelchair lift.
- A sliding ramp and lifting bridge on the AEG (MAN) GT6N vehicle in Munich (Figure 67). This device requires up to 4 min to deploy.
- Powered platform bridgeplates on the ABB (Socimi) Eurotram (Strasbourg) are installed in all four doorways (two per side) at the center carbody sections. These devices



Figure 67. Sliding ramp and lifting bridge used on the AEG (MAN) GT6N LF-LRV in Munich.

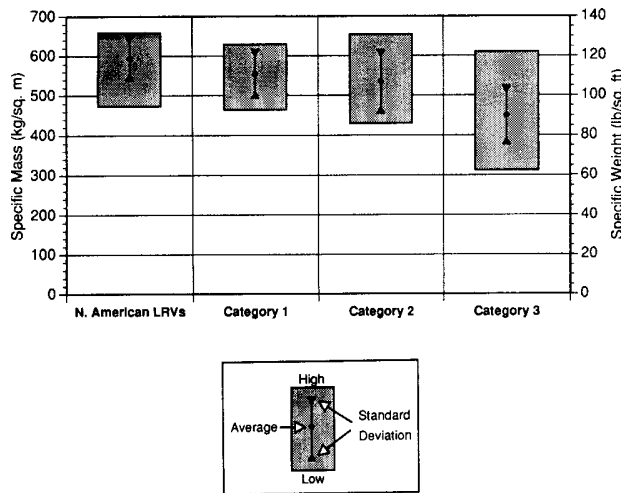


Figure 68. Comparison of specific mass for LF-LRVs and conventional North American LRVs.

are controlled from the cab by the driver, who can monitor boarding and alighting by means of closed-circuit television (CCTV).

Carbody Construction and Materials

An important goal that has guided the development of all Category-3 vehicles has been weight reduction. In addition to the weight savings from the use of innovative running gear and drive arrangements, manufacturers have tried various new materials and construction technologies. Examples of these state-of-the-art materials and construction technologies include the following:

- Breda VLC (Lille)

- The primary structural frame is fabricated from aluminum extrusions.
- Extruded aluminum side panels are bolted on to the frame—making them easy to replace.
- The cab is made from structural composite material.
- Specific mass is 557 kg/m^2 (114 lb/ft^2).

- ABB (Socimi) Eurotram (Strasbourg)

- The structure is built from wide aluminum extrusions.
- Bending stiffness is provided by a deep center sill in the roof frame.
- Windows are bonded to the structure (similar to automobile windshields).
- Interior and exterior panels are formed from GRP.
- Trim panels are secured by Velcro®-type fasteners, making graffiti control and color scheme changes easier.
- Floors are made from aluminum skin foam-core sandwich bonded to the structure (but its fire resistance is unknown).
- Specific mass is 372 kg/m^2 (76 lb/ft^2).

- Bombardier (BN) Tram 2000 (Brussels)

- A rigid steel underframe incorporates an energy-absorbing bumper—capable of absorbing a 6-km/h (3.75-mph) impact.
- Aluminum extrusion sidewalls are bolted to the steel frame and each other.
- GRP is used for ends and interior panels—the interior panels are attached with Velcro®.
- Specific mass is 608 kg/m^2 (125 lb/ft^2).

Although these are departures from conventional LRV construction, the mass reduction benefits are not obvious in terms of achieved specific mass (tare weight ÷ [length × width]). In addition, the corrosion risk associated with the use of dissimilar metals and/or aluminum as the primary structural material must be carefully considered—especially in cities where salt is essential for snow and ice clearing.

By comparison, the AEG (MAN) GT6N/GT8N vehicles, which are fabricated from stainless steel, have specific mass between 422 kg/m^2 (87 lb/ft^2) and 486 kg/m^2 (100 lb/ft^2), respectively. Figure 68 shows a comparison of specific mass for LF-LRVs and conventional North American LRVs. It will require more in-service time to determine if new innovations in construction and materials technologies will result in any life-cycle cost reductions compared to the continued use of steel.

MAINTENANCE EXPERIENCE WITH LF-LRVs

Maintenance on Category-1 LF-LRVs will not differ substantially from conventional high-floor vehicles since they use the same technologies. Most of the Category-3 vehicles have

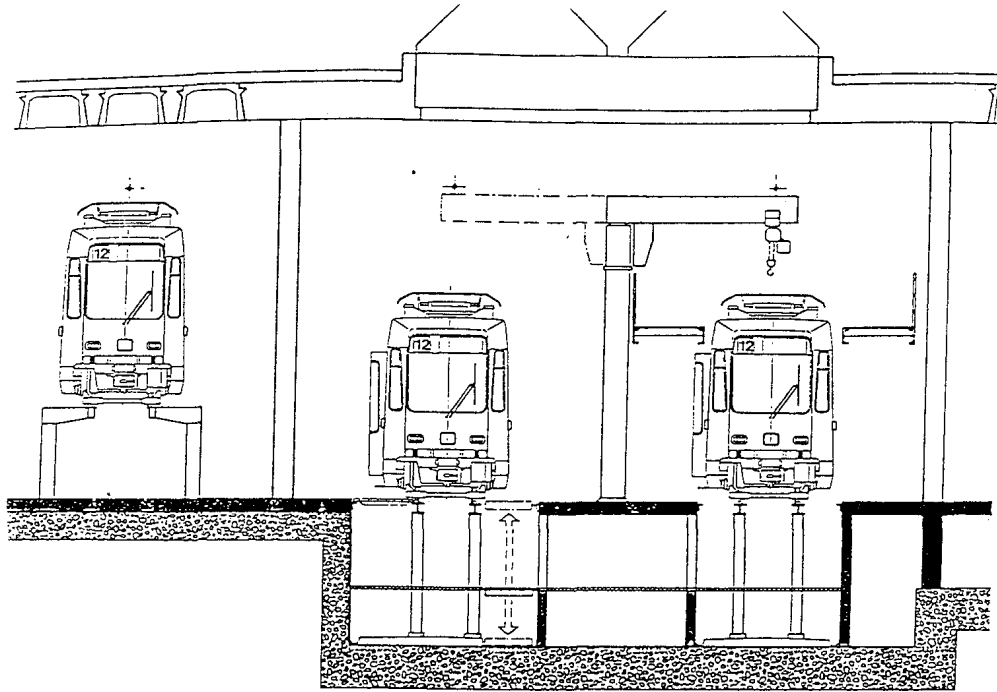


Figure 69. Geneva maintenance shop layout (schematic).

just started service, or will enter service shortly; therefore, there is no maintenance history to report. The purpose of this section is to summarize discussions with operators of Category-2 vehicles, as well as the transit agency in Munich, which has operated the AEG (MAN) GT6N prototypes since 1991.

It is standard practice for European transit operators to cooperate and work with a selected carbuilder to develop vehicles that are suited to their specific needs. Therefore, the transit operators have a vested interest in the vehicle design that they helped define and refine.

Maintenance Experience in Bern and Geneva, Switzerland

Both Bern and Geneva in Switzerland operate the ACM Vevey, Category-2 vehicles with small-wheeled trailer trucks. Both transit operators claim that maintenance is easier and consumes less time compared to the standard LRVs in their fleets. The main reasons cited were ease and speed of wheelset removal, which can be done in 15 min (conversation with Mr. Berger, Chief of Maintenance; Bern, Switzerland).

Maintenance is simplified because the shops were modified to provide good accessibility to all parts of the vehicle (Figure 69), by means of the following:

- Lifts to raise the cars up to 1,700 mm (6 ft 7 in), which enables each truck to be exchanged individually;
- A pit track with space for three vehicles, where a mobile lift table has proven convenient for underfloor equipment and power truck maintenance;
- A track with secure platforms at roof level on either side

of the vehicle, which provides easy access to the roof-mounted equipment; and

- A jib crane for lifting and lowering roof-mounted equipment.

Maintenance Experience in Kassel, Germany

The transit agency in Kassel operates the Duewag-built Category-2 vehicles that use EEF trailer wheelset technology. After some refinements, reliability of the self-steering wheelsets has reached an acceptable level (conversation with Mr. Rebitzer, Rolling Stock Engineer; Kassel, Germany). The wheelsets are considered easier to maintain because the disc brake calipers are mounted outboard of the wheels, where they are more accessible. Kassel did not perceive a difference in maintenance costs between their LF-LRVs and conventional LRVs.

Kassel also modified their maintenance shops by installing high platforms for roof-mounted equipment maintenance (Figure 70). They use CCTV to perform daily pantograph and above-roof equipment inspections more efficiently.

Maintenance Experience in Grenoble, France

Grenoble operates the first fleet of Category-2 vehicles that entered revenue service. Built by GEC-Alstom, these vehicles have four independently rotating wheel trailer trucks. The only maintenance problem has been the resilient wheels, which are heavily loaded and have more frequent replacement rates because of wear caused by the numerous track curves in Grenoble. Otherwise, Grenoble considers the reliability of these vehicles



Figure 70. Kassel maintenance shop (photo—showing access to roof equipment).



Figure 71. Munich maintenance shop (photo—showing traction motor and shop pit with sliding rail for traction motor drop).

to be acceptable (conversation with Mr. Abatista, Chief of Maintenance; Grenoble, France).

Maintenance Experience in Munich, Germany

Maintenance officials in Munich hope to achieve a 33-percent reduction in maintenance effort after all the new GT6N Category-3 LF-LRVs are commissioned and have replaced the older, conventional LRV fleet. Munich's chief of maintenance attributed this expectation partly to the development and improvement resulting from service trials with the three prototypes and partly to maintenance personnel training (conversation with Mr. Geisl, Chief of Maintenance; Munich Transportation Authority, Munich, Germany). Since the GT6N is made of stainless steel, carbody finish maintenance is expected to be reduced.

One special maintenance shop modification that the GT6N vehicles require is the provision of sliding rails on the pit track to enable dropping the underfloor-mounted traction motors that are installed above one rail (Figure 71).

All of the transit operators interviewed supported the benefits of the maintenance shop modifications in Geneva. In addition, they also saw a need to provide shop power supplies to reach equipment mounted above the roof, since the overhead traction power supply has to be discontinued in the maintenance bays to avoid electrocution of repair personnel.

PUBLISHED AND REPORTED PRICES

The first price information was originally published in *Railway Gazette* (14). However, these prices were quoted in German DM per unit floor area. The conversion of these figures to US \$ can be misleading, depending on the exchange rate originally used by the author and the current exchange rate. Moreover, it was not clear whether some of these published prices are for the prototype or the production order. A more recent article by the same author (15) gives prices for Category-2 vehicles ordered between 1993 and 1994 (the conversion to US \$ used is: \$ = DM 1.7 and \$ = FF 5.7). In addition, some prices for Category-2 vehicles were obtained directly from three transit operators. Table 8 shows prices for Category-2 vehicles.

The price of the Portland order is subject to escalation based on a formula that accounts for increases in labor indices between 1993 and the approximate date of delivery.

The manufacturers of the Brussels Tram 2000, the BN division of Bombardier Eurorail, stated that the price for each of the 51 Category-3 vehicles now being delivered was BF 63 million (conversation with engineers at the BN Division of Bombardier Eurorail). At present exchange rates of about US \$ = BF 33 (the US \$ is currently losing value), this corresponds to about \$1,900,000.

The article (15) also quotes a price of \$2,060,000 for the ABB (Henschel) Variotram ordered by Chemnitz; 53 of these 100 percent low-floor Category-3 vehicles were ordered for 1993 delivery.

It is difficult to discern any trends from these prices or to

TABLE 8 Category-2 vehicle prices

City	Builder	Length	Width	Year of Delivery	Number of Vehicles	US \$ Equivalent
Paris ¹	GEC-Alsthom	29.4 m (96 ft 5.5 in)	2.3 m (7 ft 6 in)	1991	34	2,400,000
Geneva ¹	ACM Vevey	21.0 m (68 ft 11 in)	2.3 m (7 ft 6 in)	1990	46	2,350,000
Portland (Tri-Met) ¹	Siemens-Duewag Corp.	28.0 m (92 ft)	2.65 m (8 ft 8 in)	1995	46	2,319,000
Grenoble ²	GEC- Alsthom/	29.4 m (96 ft 5.5 in)	2.3 m (7 ft 6 in)	1987	38	2,363,000
Mannheim ²	Duewag	29.9 m (98 ft 1 in)	2.4 m (7 ft 11 in)	1994	64	2,010,000
Dusseldorf ²	Duewag	28.6 m (93 ft 8 in)	2.3 m (7 ft 6 in)	—	10	1,635,000

1 Information obtained through interviews

2 Information obtained from *Railway Gazette International Year Book, Developing Metros 1994*, "German Cities Dominate Deliveries of Novel Low- and Middle-Floor Cars."

deduce from this information alone what (if any) is the price premium for LF-LRVs as a function of vehicle category or size of low-floor area. There are simply too many factors that influence prices to make comparisons between vehicles. Some of these factors, which vary from operator to operator, include different specified equipment and interior furnishings, order size, commercial terms, type of procurement process, subsidies, and exchange rates.

Other anecdotal evidence recorded during this research suggests that the premium is quite small:

- TRI-MET reported that Siemens-Duewag Corporation quoted a 10 percent increment above the price of a

conventional high-floor LRV built to the same specification. This 10 percent premium was due to the redesign work needed to change from European specifications to North American specifications, as part of the initial transfer of technology.

- Bombardier Eurorail's division stated that their policy is to produce and sell their 100 percent low-floor Tram 2000s for the same price as a comparable, conventional high-floor LRV. This presumably is possible now that the development costs of the sophisticated running gear have been either recovered from the first order or have been written off (conversation with engineers of BN Division of Bombardier Eurorail).

CHAPTER 3

APPLICATION CONSIDERATIONS

There are several significant issues that North American LRT systems should examine when considering low-floor light rail vehicles (LF-LRVs). This chapter introduces these applicability issues as a precursor to the categorization of the North American LRT systems (Chapter 4) and the application assessment framework (Chapter 5), where the issues are more fully developed.

The applicability issues fall into three broad categories:

- **Dimensional Compatibility.** Will the proposed LF-LRV physically fit in an existing infrastructure? What modifications will be required to the existing infrastructure, the vehicle, or both? A new LRT system will probably be free of such physical constraints; nevertheless, the factors discussed in this area should help LRT system planners understand the issues related to integrating LF-LRVs with a future system.
- **Operating Issues.** What are the benefits and disadvantages that LF-LRVs will bring to an existing or planned LRT system (as viewed from an operator's perspective)?
- **Compliance with North American Specifications.** What are the factors unique to North America that will impose requirements that European LF-LRVs may not have been designed to meet?

DIMENSIONAL COMPATIBILITY

The critical factors in assessing dimensional compatibility are concerned with the physical interfaces between a particular vehicle design and an existing or proposed new LRT system infrastructure and include the following:

- Vehicle/station platform interface;
- Vehicle and train length;
- Maintenance facility and equipment interfaces;
- Clearance; and
- Ability to negotiate curves.

Each critical application factor in this category is discussed in the following sections.

Vehicle/Station Platform Interface

There are three areas discussed under vehicle/station platform interface—high-platform interface, low-platform interface, and street-level boarding.

High-Platform Interface. A vehicle with all low-floor entrances cannot be used at stations with high platforms. The only way that a LF-LRV can be used on routes with high platforms is to build the vehicle with at least one high-floor door and entrance. This restriction clearly rules out the use of Category-3 vehicles (100% LF-LRVs).

Low-Platform Interface. Although LF-LRVs can be boarded from TOR level by most passengers, the entrance floors are still high enough to preclude unassisted boarding by persons using wheelchairs or other mobility devices and to make boarding difficult for others with mobility problems. In order to solve this interface problem and obtain the maximum benefits in terms of reduced boarding and alighting times, it has become standard practice to build a low platform or raised curb at station stops whenever possible.

The most efficient design (from the point of view of entry/egress) can be achieved if the low platform is at the same level as the vehicle floor. However, the following potential interface problems and requirements must be addressed:

- Existing high-floor LRVs may be required to stop at the same station, in which case the platform height should ideally be below the level of the bottom step of the conventional vehicle.
- If the conventional high-floor LRVs have outward folding passenger doors, the platform must be below the bottom edge of the doors, otherwise the doors cannot open.
- The door threshold height will vary because of
 - Suspension deflection under fluctuating passenger load;
 - Leveling control tolerance or malfunction;
 - Emergency operation with failed springs;
 - Uncompensated wheel and rail wear; and
 - Vehicle manufacturing tolerances.

The allowances recommended by the German Association of Public Transport Operators (VDV) for each of these movements are shown in Table 9. The VDV recommends that the platform should nominally be designed to be 50 mm (2 in) below the door entrance threshold, when the vehicle is at tare weight.

The ADA imposes a stringent requirement of no more than a ± 16 -mm (0.625-in) height mismatch between the entrance threshold and platform (Figure 72). This makes it extremely likely that some form of floor-height control

TABLE 9 VDV-recommended vertical and horizontal tolerances and suspension movements

	Vertical Tolerances and Suspension Movements	
	mm	in
Primary suspension deflection	10	0.39
Uncompensated wheel wear	10	0.39
Rail wear	15	0.59
Vehicle manufacturing tolerance	5	0.20
Platform build tolerance	10	0.39
Total Vertical Level Difference	50	1.97
Additional allowance for emergency operation with failed secondary suspension	30	1.18
TOTAL WORST CASE	80	3.15

Note: VDV recommends that platforms should be 50 mm (2 in) below the threshold level of an empty vehicle to allow for these tolerances and movements

	Horizontal Tolerances and Suspension Movements	
	mm	in
Flangeway clearance	5.0	0.20
Wheel flange wear	100	0.39
Rail head (gauge side) wear	100	0.39
Track alignment error	5.0	0.20
Primary suspension deflection	2.5	0.10
Secondary suspension deflection	100	0.39
Vehicle manufacturing tolerance	5.0	0.20
Car yaw relative to platform	350	1.38
Platform build tolerance	5.0	0.20
TOTAL LATERAL GAP	87.5	3.44

system, such as automatic load leveling, will be needed to compensate for deflections in the suspension system. Platform construction tolerances will exacerbate the height mismatch.

- Stations located on curved track may pose an additional problem because the carbody will be parallel to a chord line connecting the running gear (Figure 73). Therefore, a significant lateral gap may exist between the entrance threshold and the low platform. The gap must be limited to 76 mm (3 in) to comply with the ADA.

Some vehicle/platform interface problems can be solved by providing the LF-LRV with a bridgeplate or ramp at the entrances intended for wheelchair boarding. A variety of solutions have been developed that use powered or manually deployed mechanisms.

Street-Level Boarding. In the case where vehicles run in the outer lanes on city streets and it is not practical to have plat-

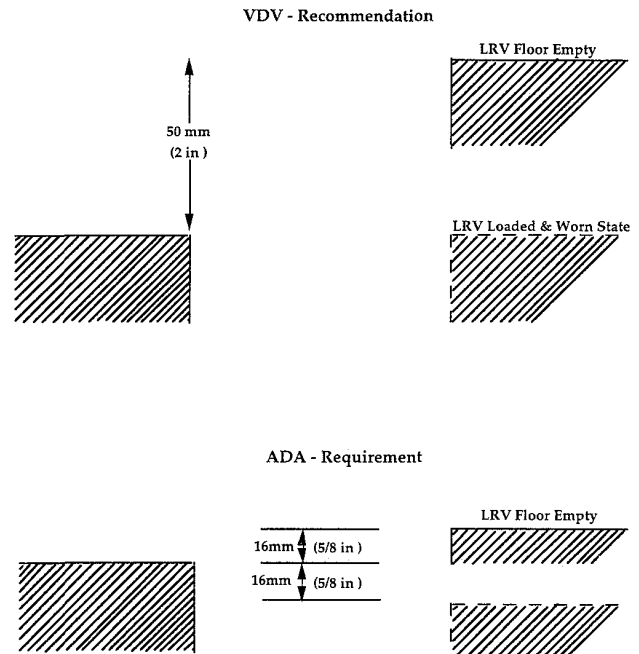


Figure 72. Vehicle/platform interface.

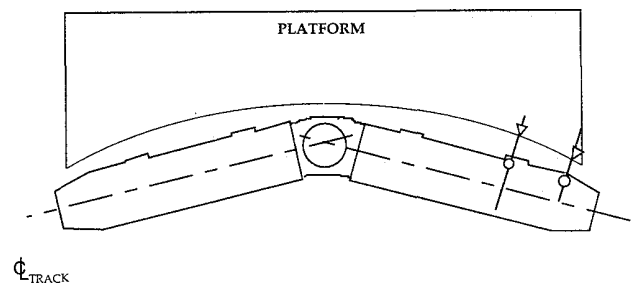


Figure 73. Stations on curved track/platform interface.

forms of any height, the only way to provide access to persons with disabilities is by means of a vehicle-borne lift or telescoping ramp. Unfortunately, the deployment time of these devices is currently almost the same as for a wheelchair lift on a high-floor LRV.

Vehicle and Train Length

LF-LRVs can be designed and built to almost any length, depending on required capacity and infrastructure constraints. Category-1 vehicles are usually longer, in the range of 25.4 m (83 ft 4 in) to 39.15 m (128 ft 5 in). If they are created from a six-axle conventional LRV (by adding a low-floor center section), the original length will typically increase by at least 6 m (20 ft). If LF-LRVs are longer than the LRT system was originally designed for, the following will need to be considered:

- Stations will need to be modified to increase the length of platforms, rain shelters, etc.
- Signs and signals will need to be relocated.
- Stations will need to be moved away from street intersections to avoid blocking them.

Another consideration is whether the new LF-LRVs will be coupled with existing conventional LRVs of a different length. This is operationally undesirable because the train may enter the station with either the short or the long car leading, necessitating changes to wayside equipment and two sets of berthing indicators on the wayside. These may confuse drivers, and will cost more. Both MBTA and TRI-MET have specified LF-LRVs that are the same length as their existing vehicles in order to avoid problems like these.

Maintenance Facility and Equipment Interfaces

A third issue regarding dimensional compatibility is whether the vehicle will fit in maintenance workshops, the car wash facility, storage tracks, and paint booths. In addition, vehicle length must be compatible with equipment such as floor hoists (the corresponding underframe jacking pads must also match) and underfloor wheel truing lathes.

These factors will favor selecting a vehicle that is approximately the same length as the existing maintenance facilities were originally designed to accommodate. However, some modifications to shop equipment may still be required. Category 2- and Category-3 vehicles have predominantly roof-mounted equipment. Therefore, if Category-2 and Category-3 LF-LRVs are considered, modifications will be needed to install secure, roof-level servicing platforms and overhead lifting cranes (if they do not already exist). The approach that European LRT systems have taken was discussed in Chapter 2. TRI-MET has decided to build an entirely new maintenance facility to service its new LF-LRVs.

Clearance

The application of any rail vehicle to an existing infrastructure requires careful study to ensure that it will not encroach on the specified dynamic outline, under both normal and emergency operating conditions. Similarly, the clearance between the running gear and the vehicle underbody must also be ensured. LF-LRVs present some concern because the undercar space is smaller, however

- In most cases, the low floor is at approximately the same height as the bottom step of a conventional high-floor LRV.
- The low gangway takes up space normally occupied by the underframe-mounted equipment in conventional high-floor LRVs.

Nevertheless, it is essential to verify that clearance is adequate on the particular track geometry of the proposed application, taking into account the following:

- Small radius vertical curves combined with a large truck center distance (or single wheelset spacing) may significantly diminish the undercar clearance. This may be particularly problematic on designs like the Sheffield and Freiburg GT8D LF-LRVs that have low-floor outer body sections.
- Category-3 LF-LRVs (such as the AEG[MAN] GT6N/8N and Duewag R3.1), which are carried on a single truck in the center of each body section, have large overhangs and will require greater clearance at the entry to and exit from horizontal curves. The overhang may cause even greater difficulties on reverse curves.
- Operation of the ultra low-floor vehicles (such as the SGP ULF 197) in cities that get substantial amounts of snow may require the tracks to be plowed before service starts. This was found to be necessary in Vienna.
- The clearance between the overhead catenary and the roof, especially in maintenance shops, may have to be increased to permit removal and installation of roof-mounted equipment.
- Traversing vertical curves will cause trucks and their wheels to pitch up relative to the carbody, therefore, four-wheel trucks require more underfloor clearance than single wheelsets.

Ability to Negotiate Curves (Curving Ability)

According to the published data collected during this research, all three categories of LF-LRVs contain vehicles that can negotiate horizontal curves down to a 20-m (66-ft) radius and this can be achieved by most types of running gear. The curving ability of LF-LRVs appears to be as good or better than most conventional LRVs. Category-1 LF-LRVs, which are defined as having conventional motored and trailer trucks, are generally less capable than Category-2 and Category-3 vehicles in this context.

In fact, it will probably be possible to modify most Category-2 and Category-3 vehicles to enable them to traverse tight curves. An issue to be considered is which design can do this with the least wheel and rail wear and noise. In theory, the best performance should be obtained from self-steering or force-steered running gear, but there are insufficient data to quantify the benefit.

Small radius reverse curves, with very short or no tangent sections in between (such as on the MBTA's Green Line), will require very careful analysis to determine whether certain types of LF-LRVs can negotiate them. This is especially true for the AEG (MAN) GT6N/8N (Bremen and Munich) and the Duewag R3.1 (Frankfurt) type vehicles. These vehicles have a single truck in the middle of each carbody section and floating articulations. The yaw angle of the truck, with respect to the carbody and between adjacent body sections, may be exaggerated on such severe reverse curve geometry. Moreover, the GT6N/8N accommodates truck yaw by virtue of the shearing flexibility of the air springs, which may be insufficient for the extreme movements resulting in such circumstances.

OPERATING ISSUES

There are six critical operating issues that need to be considered:

- ADA compliance (for agencies in the United States),
- Boarding and alighting times,
- Mixed-fleet operation,
- Fare collection,
- Performance, and
- Maintenance.

ADA Compliance

Public Law 101-366 (July 26, 1990), the Americans with Disabilities Act of 1990 (ADA), is a major institutional factor in the United States. It imposes particular demands on the operation of light rail vehicles. The following sections are excerpts from Title II, Part 1 of the Act.

Section 222. PUBLIC ENTITIES OPERATING FIXED ROUTE SYSTEMS.

(a) Purchase and Lease of New Vehicles.—It shall be considered discrimination for purposes of section 202 of this Act and section 504 of the Rehabilitation Act of 1973 (29 U.S.C. 794) for a public entity which operates a fixed route system to purchase or lease a new bus, a new rapid rail vehicle, a new light rail vehicle, or any other new vehicle to be used on such system, if the solicitation of such purchase or lease is made after the 30th day following the effective date of this subsection and if such bus, rail vehicle, or other vehicle is not readily accessible to and usable by individuals with disabilities, including individuals who use wheelchairs.

(b) Purchase and Lease of Used Vehicles.—Subject to subsection (c)(1), it shall be considered discrimination for purposes of section 202 of this Act and section 504 of the Rehabilitation Act of 1973 (29 U.S.C. 794) for a public entity which operates a fixed route system to purchase or lease, after the 30th day following the effective date of this subsection, a used vehicle for use on such system unless such entity makes demonstrated good faith efforts to purchase or lease a used vehicle for use on such system that is readily accessible to and usable by individuals with disabilities, including individuals who use wheelchairs.

(c) Remanufactured Vehicles. —

(1) GENERAL RULE.— Except as provided in paragraph (2), it shall be considered discrimination for purposes of section 202 of this Act and section 504 of the Rehabilitation Act of 1973 (29 U.S.C. 794) for a public entity which operates a fixed route system -

(A) to remanufacture a vehicle for use on such system so as to extend its usable life for 5 years or more, which remanufacture begins (or for which the solicitation is made) after the 30th day following the effective date of this subsection; or

(B) to purchase or lease for use on such system a remanufactured vehicle which has been remanufactured so as to extend its useful life for 5 years or more, which purchase or lease occurs after such 30th day and during the period in which the usable life is extended; unless, after remanufacture, the vehicle is, to the maximum extent feasible, readily accessible to and usable by individuals with disabilities, including individuals who use wheelchairs.

Section 228. PUBLIC TRANSPORTATION PROGRAMS AND ACTIVITIES IN EXISTING FACILITIES AND ONE CAR PER TRAIN RULE.

(b) One Car Per Train Rule. —

(1) GENERAL RULE.—Subject to paragraph (2), with respect to 2 or more vehicles operated as a train by a light or rapid rail system, for purposes of section 202 of this Act and section 504 of the Rehabilitation Act of 1973 (29 U.S.C. 794), it shall be considered discrimination for a public entity to fail to have at least 1 vehicle per train that is accessible to individuals with disabilities, including individuals who utilize wheelchairs, as soon as practicable but in no event later than the last day of the 5-year period beginning on the effective date of this section.

[The reader is directed to the Federal Register, Part IV Department of Transportation, 49 CFR Part 37 for discussions and interpretation regarding ADA.]

The impact of these clauses on planned and existing LRT systems is discussed in the subsequent section.

Planned LRT System. Policy makers at planned LRT systems have two procurement options:

- Purchase LF-LRVs and make them accessible by means of low platforms and/or lifts.
- Purchase conventional LRVs and make them accessible by means of one or an appropriate combination of the following options:
 - Wayside lifts providing access to high-floor entrance(s);
 - High platforms, long enough to berth a train;
 - Short length, high platforms to match one high-floor entrance;
 - Vehicle-borne wheelchair lifts; and
 - Manually deployed vehicle fold-down platforms.

Existing LRT System. The issues facing existing LRT systems are more complex and depend on whether:

- The existing system has exclusively high-platform loading, in which case compliance with the accessibility requirements may not be an issue.

- The acquisition of LF-LRVs is contemplated solely to meet the one car per train rule.
- New vehicles must be procured anyway to replace rolling stock that has reached the end of its useful life and/or to cope with ridership growth.

If LF-LRVs are only being procured to meet the one car per train rule, it must be recognized that some inefficiencies may accrue, e.g., extra LF-LRVs may be required to match existing numbers, or some of the existing vehicles may be used less frequently or become surplus before reaching the end of their useful lives. Under these circumstances, the trade-off will be among

- Buying the minimum number of LF-LRVs required to meet the one car per train rule;
- Equipping some of the existing vehicles with wheelchair lifts or high/low steps, or vehicle fold-down platforms in conjunction with mini-high platforms, to meet the one car per train rule; and
- Providing wayside lifts.

If vehicles are procured to replace rolling stock that has exceeded its useful life or to keep up with increased ridership growth, the number of vehicles to be procured will be dictated by service frequency requirements and the problem of surplus vehicles should not arise. The preferred option for meeting the ADA accessibility requirements will depend on the size of the new vehicle order relative to the number of existing vehicles to be retained.

Boarding and Alighting Times

One potential benefit of operating LF-LRVs is reduced station dwell time because of more efficient boarding, movement through, and alighting from the vehicle. The benefit has two components:

- Quicker entry and egress by passengers who do not need to ascend or descend steps, especially if they are carrying bags or pushing strollers. The full value of this benefit will only be realized if the train is composed entirely of LF-LRVs. If the train is made up of a mix of LF-LRVs and conventional LRVs, the boarding and alighting times will improve depending on the ratio of level to nonlevel entrances.
- Elimination of the time required to use a wheelchair lift or manual fold-down platform to cover the stepwell. This is the main benefit for LRT systems with low-platform stations to consider. It reduces the unreliability of the schedule caused by lift/fold-down platform operation.

The tangible benefits that accrue can be quantified (see Chapter 5) in terms of capital and operating costs saved by the transit system, and the value of time saved by passengers as follows:

- Capital cost reduction occurs if the reduction in the round-

trip time is equivalent to or exceeds the operating headway, then one less train is required to provide a given service level.

- Operating cost reduction comes from the savings in labor no longer required to operate and maintain the eliminated train(s).
- The value of time saved by passengers is currently assessed by the FTA as
 - \$4.80 per hour for commuting trips and
 - \$2.40 per hour for all other trips.

Mixed-Fleet Operation

Many of the North American LRT systems have been built within the last 20 years. They are operating conventional LRVs that have not yet reached the end of their useful life. Older LRT systems that purchased vehicles in the same period also have this situation. In most cases, it will be economically necessary to be able to operate multiple unit trains composed of existing vehicles and new LF-LRVs. This should be feasible with Category-1 and Category-2 vehicles but would be difficult with Category-3 LF-LRVs, as presently designed, because of differences in coupler height.

For example, the Bombardier (BN) Tram 2000 for Brussels was supplied for single vehicle operations only. For future orders, the vehicle has been designed so that an automatic coupler can be installed. This will enable Tram 2000s to be operated in trains but not to be coupled to different vehicles. The situation with the other Category-3 vehicles was not fully explored during this research.

On the other hand, the experiences of TRI-MET and MBTA demonstrate that Category-2 LF-LRVs can readily be designed to operate with existing vehicles. The same is true for Category-1 LF-LRVs, especially if they are created by adding a center section to a six-axle conventional LRV, in which case the coupling interface is inherently provided. It should be realized, however, that the ability to compose mixed trains may require modifications to the existing cars to enable control from any cab. For example, remote activation of a powered ramp from the cab of an existing vehicle requires the addition of controls, trainlines, and coupler contacts (unless spares already exist).

In addition, it is appropriate to specify that LF-LRV characteristics be matched with those of the existing vehicles with respect to

- Performance—to avoid uncomfortable jerk and obtain equal tractive effort from every vehicle in the train; and
- Crashworthiness—to minimize the risk of the stronger vehicle penetrating the weaker in a collision.

The LF-LRV ends must also be designed to allow for the relative movements between coupled cars when negotiating vertical and horizontal curves. This may preclude use of an existing LF-LRV design unless its ends are suitably modified.

While these requirements are not particularly difficult to accomplish, they will entail additional engineering costs, which

may be significant on a per car basis if only a small number of LF-LRVs are ordered.

Fare Collection

The dwell time reduction obtained from using LF-LRVs, compared to boarding high-floor LRVs with steps, is achieved only if passengers can board the vehicle via the low-level entrances. This will not be the case in those Category-1 and Category-2 vehicles that have on-board fare collection adjacent to the driver's cab in the high-floor part of the vehicle.

There are three alternatives to resolve this problem—change to a proof-of-payment fare collection scheme, collect fares at stations, or utilize 100 percent low-floor vehicles. While the third alternative will improve the boarding rate it still requires all passengers to enter at one entrance, whereas dispensing with on-board fare collection permits all low-floor entrances to be used for maximum efficiency.

If on-board fare collection is deemed essential, it is important to select a LF-LRV that is operationally compatible with the station platform layout. On some LRT systems, boarding at the front of the vehicle from a right-hand door at one station may be followed by a requirement to exit from a rear door on the left-hand side of the vehicle (e.g., MBTA). This may preclude the use of some Category-3 vehicles, which have narrow low-floor aisles over their trucks that are not sufficiently wide to permit the passage of a person in a wheelchair.

Performance

To benefit from the trip-time reductions that accrue from shorter station dwell times, LF-LRVs must be adequately powered to deliver performance similar to conventional high-floor LRVs. Depending on route profile, this factor could favor one category of LF-LRV over another, but it is unlikely to negate a decision to use LF-LRVs instead of conventional ones.

LRT routes that have closely spaced stations, especially on city streets, require vehicles that can accelerate and brake at the maximum rates consistent with passenger comfort criteria. This will favor LF-LRVs that power all their wheels (all wheels are usually braked anyway), especially if wheel/rail adhesion can be marginal in inclement weather or the route contains steep grades. However, in practice, perfectly adequate performance can be obtained from cars by motoring four out of six wheelsets. Eight-axle, Category-1 vehicles that have only four axles motored may not have adequate performance in some applications. Similarly, some of the Category-3 LF-LRVs may be underpowered.

The trip time on LRT routes with longer distances between stations is more sensitive to maximum speed. The top speed of many existing LF-LRVs, especially in Category 3, is often 70 km/h (44 mph). This is significantly less than the 80 to 90 km/h (50 to 56 mph) maximum speed capability of most conventional LRVs currently operating in North America.

TRI-MET's experience appears to demonstrate that a Category-2 vehicle, which typically has the same amount of specific power as conventional six-axle LRVs, can easily

achieve the same maximum speed. Category-1 LF-LRVs can be provided with all motored trucks to give very high specific power and maximize the use of adhesion.

The maximum speed of Category-3 vehicles appears to be design limited rather than power limited. It is unclear whether the compact water-cooled hub motors, which have found widespread application on Category-3 running gear, have sufficient thermal capacity to cope with the duty cycle of some North American LRT systems. The concern is more acute in the case of a direct drive hub motor configuration.

Maintenance

Maintenance is a function of reliability and maintainability. Reliability is a measure of the frequency of equipment failure and the consequential need for corrective maintenance action. It is measured and specified in terms of time or distance between failures. It indicates the level of inspection and preventive maintenance effort, because highly reliable hardware need not be checked and adjusted often. Maintainability is a measure of the time and, therefore, labor required to repair and restore a failed function or component.

Unfortunately, objective data have not been collected to quantify these characteristics. Manufacturers claim, and European transit operators expect, a reduction in maintenance effort, but only time will tell whether this is a realistic expectation. In the meantime, several important factors should be considered in assessing the applicability of LF-LRVs.

Category-1 vehicles will have substantially the same, if not identical, trucks to the conventional LRVs from which they may have been derived, as well as the same subsystems and equipment. On many Category-1 vehicles, subsystems and other equipment are mounted below the floor of the outer carbody sections using the original installation methods. Therefore, Category-1 vehicles will be familiar to maintenance personnel and will likely require about the same level of effort per passenger-mile.

Category-2 and Category-3 vehicles have roof-mounted equipment, which is easier and more accessible to inspect, repair in place, and remove and replace. The installation hardware is also simpler because there is no need to avoid bolts in tension or special brackets that prevent equipment from falling on the track. In addition, running gear and propulsion machinery components on Category-3 vehicles are smaller and lighter, and therefore, easier to handle. Installation is also outboard of the wheels, which provides good access. The same is true for small wheel trucks and brake parts on Category-2 vehicles.

There are several disadvantages that will tend to increase maintenance efforts. These disadvantages were mentioned in Chapter 2 and are restated as follows:

- More numerous components that can fail and require repair. (For example, four motors, gearboxes, discs, and brake mechanisms on some independently rotating four-wheel trucks compared to one or two motors and two each of the other parts on a classical power truck);
- Additional equipment, which is required for LF-LRVs (such as door threshold ramps);

- Unsprung components that endure higher shock and vibration;
- Use of hydraulic actuation, instead of pneumatic, owing to space limitations (hydraulic systems require greater care and cleanliness during maintenance);
- Higher precision and more complex assemblies, such as steering linkages, which require more care and checking after rebuild.

It is difficult to generalize these advantages and disadvantages. A systematic reliability and maintainability evaluation needs to be carried out for the specific new LF-LRV technology. Even then it may be difficult to come to a definite conclusion. For example, in the absence of service experience, it will be difficult to quantify the difference between maintenance of a traction motor water-cooling system and a forced air ventilation system. The water-cooled system has the added burden of air/water heat exchanger maintenance but does not experience filtration and snow ingestion problems.

One way to try to solve this problem is to turn it back to the vehicle builder and suppliers by specifying performance-based, minimum reliability and maintainability developed from experience with existing vehicles. However, the problem then shifts to assessing the credibility of the proposals received and the risk that the purchaser will only get as much as demanded.

In conclusion, at this time Category-1 and Category-2 vehicles represent a lower risk of escalating maintenance effort. Conversely, they do not provide as many of the potential maintenance improvements designed into Category-3 vehicles.

COMPLIANCE WITH NORTH AMERICAN SPECIFICATIONS

European and other foreign car builders have been supplying rail vehicles to North American transit agencies for the past 30 years, managing to comply with the generally more stringent specifications. TRI-MET's experience demonstrates that North American specifications are achievable in Category-2 LF-LRVs. This section discusses the following North American specifications, which are considered most difficult and expensive to meet, particularly in Category-3 vehicles:

- Buff load and compression strength, and
- Fire resistance.

Buff Load and Compression Strength

Buff load is the static longitudinal force that a rail vehicle must be capable of withstanding without permanent deformation to its primary structure. It is intended to ensure that the vehicle body will not collapse and the driver or passengers will not be crushed in the event of a collision with other vehicles. Therefore, it is specified to act on the anticlimber, which logically must be at the same level as other vehicles sharing the tracks. The magnitude of the buff load varies from transit operator to transit operator (usually 150% to 200% of the vehicle's tare weight for North American systems) and appears to be

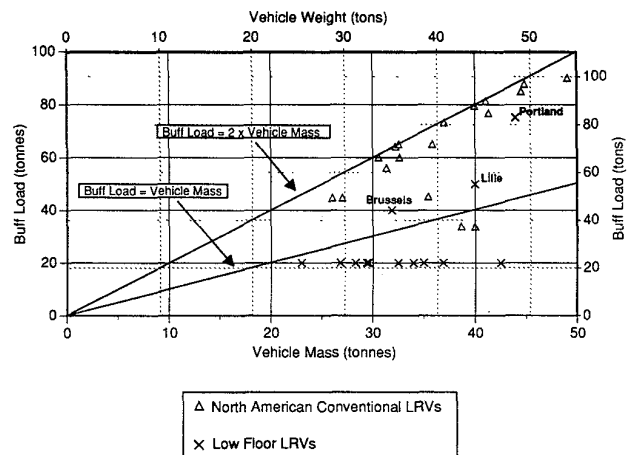


Figure 74. Comparison of buff load.

determined mainly by historical precedent and the exclusivity of the right of way. Figure 74 shows a comparison of typical North American buff load specifications.

It seems logical and legally prudent for vehicles that run on an exclusive right of way to have the same compression strength as any existing LRV using that right of way. This is the philosophy adopted by TRI-MET and MBTA and will likely be typical of other LRT systems. Where the LRVs share tracks used by other rail vehicles, as in San Diego, Cleveland, and Baltimore, local and national regulations will have to be satisfied. In either case, this tends to result in higher buff load requirements than European LF-LRVs, which are typically 20 or 40 tonnes (44,000 to 88,000 lb). The Breda VLC for Lille is an exception—it was designed to withstand 50 tonnes (110,000 lb).

Theoretically, new exclusive right-of-way LRT systems are free to specify lower buff loads, but in practice, they are unlikely to accept the liability risk that a radical decrease may bring. Similarly, there is no technical reason for LRVs to be stronger than buses or trucks, but operators will probably not want to degrade the compression strength standard of previous vehicle specifications for fear of legal repercussions in the event of an accident that causes injury.

Clearly, the majority of existing LF-LRVs must be strengthened to be applicable to North American LRT systems. This is entirely feasible and should not be particularly difficult to achieve on Category-1 and Category-2 LF-LRVs. Category-3 vehicles, however, appear to require extensive design modifications because

- They are more likely to be made of aluminum extrusions or material combinations that do not readily lend themselves to local reinforcing, and
- The end structures are unlikely to match the end sill and anticlimber of an existing vehicle with which they may be required to operate.

Fire Resistance

North American specifications contain more stringent flammability, smoke emission, toxicity, and fire resistance standards

than European LRVs are usually designed to meet. In the past, car builders have successfully fire hardened their designs to meet North American criteria, but the task has been more difficult in the case of the floor fire resistance of cars made from aluminum, because of its lower melting point. The pertinent requirement in this context is for a crush loaded floor sample to survive the American Society for Testing Materials (ASTM) E-119 test for at least 15 min.

Cars with steel floor crossings or corrugated floor sheets have successfully passed this test, but those made of aluminum

typically require the protection of a stainless steel sheet and a significant thickness of insulation. Consequently, there is a weight and cost penalty associated with fire hardening, which may obviate the weight savings achieved in the first place. In some cases, the floor construction may not be suitable at all. For example, the ABB (Socimi) Eurotram floor is made from an aluminum sheet-foam core sandwich reminiscent of the first BART cars built by Rohr in the early 1970s. In 1979, a fire in the Transbay tube destroyed seven cars. The entire fleet was subsequently retrofitted with fire hardened material.

CHAPTER 4

NORTH AMERICAN LIGHT RAIL TRANSIT SYSTEMS CHARACTERISTICS

A study of representative North American LRT systems was conducted to assess the applicability of low-floor light rail vehicles (LF-LRVs). Relevant data were collected from a survey and a review of published information. A comprehensive data summary is provided in Appendix B.

A discussion of issues, opportunities, and constraints regarding possible deployment of LF-LRVs is provided herein. For ease of understanding, we have organized data and information into five categories, as follows:

- Platform Characteristics,
- Right-of-Way Characteristics,
- System Characteristics,
- Operations Characteristics, and
- Vehicle Characteristics.

Discussion of opportunities and examples are provided to enhance the reader's understanding of issues and to place findings in a North American context. Given the level of detail provided in this report, it is not possible to assess which transit agencies should or should not add LF-LRVs to their fleets. Each transit agency seriously considering the use of LF-LRVs will need to conduct its own in-depth study of the issues.

PLATFORM CHARACTERISTICS

Platforms are one of the most important elements affecting the potential use of LF-LRVs on an existing LRT system. There are two key questions that must be answered—will the existing platforms accommodate the use of LF-LRVs, and are the platforms easily adaptable? Our review and analysis of North American LRT data has shown that existing LRT systems can be split into three basic groups:

- **Low Platform**—this group comprises LRT systems that have stations without platforms, with low platforms, with mini-platforms for boarding wheelchair users only, or with street curbs of a height up to 360 mm (14 in) above TOR. These systems are considered good candidates for LF-LRV application.
- **Low/High Platform**—this group comprises LRT systems that have a combination of low- and high-station platforms (e.g., high-level boarding in stations within a tunnel and low-platform boarding outside). These systems are considered possible candidates for LF-LRV application.
- **High Platform**—this group comprises LRT systems that have exclusively high-platform stations with the platform

being equal to or greater than the train length, and at a nominally constant elevation in the range 910 mm to 1,020 mm (36 in to 40 in) above TOR. These systems are considered unlikely candidates for LF-LRV application on existing lines and extensions to existing lines.

A survey of North American LRT systems was conducted (Table 10). The agencies shown in bold type are either in the process of procuring LF-LRVs or are actively pursuing the

TABLE 10 List of North American agencies included in the survey of LRT systems

City	Agency	Type of Platform
Baltimore	MTA	Low
Boston	MBTA	Low
Buffalo	NFTA	Low/High
Calgary	CT	High
Chicago	City of Chicago	Low
Cleveland	GCRTA	Low
Edmonton	ET	High
Los Angeles	LACMTA	High
Newark	NJT	Low
Philadelphia	SEPTA	Low
Philadelphia (Norristown)	SEPTA	High
Pittsburgh	PAT	Low/High
Portland	TRI-MET	Low
Sacramento	RT	Low
San Diego	MTD	Low
San Francisco	MUNI	Low/High
Santa Clara	SCCTA	Low
St. Louis	BSDA	High
Toronto	TTC	Low

idea. Note that any of these agencies could decide to construct a new LF-LRV line to complement existing LRT service. All new LRT systems are considered good candidates for LF-LRV application. Four platform characteristics are discussed in greater detail—platform height, platforms in tunnels, level boarding, and door encroachment.

Platform Height

In order to obtain level boarding without the use of telescoping ramps, station platforms must match the LF-LRV floor height. For some transit agencies, this would mean raising the level of an existing curb or platform. These agencies would also have to consider the height of the lowest step on their existing conventional vehicles, architectural restrictions, existing structures, and boarding points (e.g., whether there is boarding directly from the street). The following systems exhibit some boarding directly from street level: Boston, Philadelphia, Sacramento, Toronto, and Buffalo.

Raising a platform to allow level boarding may result in a need to modify the step height of the conventional vehicles to ensure that the step is not lower than the platform height.

Platforms in Tunnels

Where existing high-platform LRT stations have been constructed within tunnels, platform modifications to accommodate low-floor vehicles would be technically difficult, disruptive to service, and consequently costly to implement. LRT systems that fit this criterion include Buffalo, Edmonton, Los Angeles, Pittsburgh, San Francisco, and St. Louis.

Level Boarding

Many transit agencies have invested in equipment or infrastructure improvements to enable level boarding at all stops, while other agencies provide alternative solutions. Level boarding can be provided by combining high-floor cars with high platforms, or low-floor cars with low platforms. All North American systems that provide level boarding currently use high-floor cars. Figure 75 lists the principal access features currently in place at North American LRT systems.

Door Encroachment

Some LRVs are equipped with doors that open or fold outward. If these LRT systems install raised platforms to allow level boarding of vehicles, it is imperative that the top of platform elevation be set lower than vehicle door bottoms to facilitate door opening. A vehicle load-leveling system retains the LRVs floor height at a constant level, regardless of the vehicle load. The following systems have outward opening or folding doors:

- Baltimore (load leveling),
- Boston (load leveling),
- Cleveland (no load leveling),

- Portland (no load leveling),
- Sacramento (no load leveling),
- San Diego (no load leveling), and
- Santa Clara (load leveling).

RIGHT-OF-WAY CHARACTERISTICS

Two right-of-way characteristics of North American LRT systems are discussed in detail—minimum horizontal curve radius and steep grades.

Minimum Horizontal Curve Radius

Existing track horizontal curve radii may restrict the use of some LF-LRVs or at least have an impact on their cost. The data presented in Chapter 2 and Appendix A indicate that the three categories of LF-LRVs, as presently designed, can meet the following minimum horizontal curve requirements:

- Category 1: 20 m (66 ft)
- Category 2:
 - Small wheel trailer trucks 18 m (59 ft)
 - Independently rotating four-wheel trucks 18 m (59 ft)
 - EEF wheelsets 15 m (49 ft)
- Category 3: 15 m (49 ft)

LRT systems on which the existing minimum curve radius falls below 15 meters include:

- Boston—10 m (33 ft) and 13 m (43 ft) for the Green and Mattapan lines, respectively;
- Newark—10 m (33 ft);
- San Francisco—13 m (43 ft); and
- Toronto—11 m (36 ft).

Although this does not rule out any of the three vehicle categories on any of the candidate systems, LF-LRV builders would have to adapt existing designs to meet tight radius requirements.

Steep Grades

Some of the existing LF-LRVs have only half of their wheels motored. This places a high demand on adhesion and would prevent the use of such LRVs on systems with steep grades (8% or greater). LRT systems that experience a significant number of days of inclement weather would have similar concerns about adhesion capabilities. Accordingly, Category-1 vehicles created by adding a low-floor center section and a second trailer truck to a six-axle conventional LRV, and Category-2 and Category-3 vehicles that only have half their wheels motored, may not be readily acceptable in Baltimore, Boston, Cleveland, Pittsburgh, San Francisco, and Toronto.

		Level Boarding	Wayside Ramp	Fold-down Platform	Wayside Lift	Car-borne Lift	Steps on Car
Low Platform	Baltimore		✓	✓			✓
	Boston						✓
	Cleveland						✓
	Newark						✓
	Philadelphia						✓
	Pittsburgh						✓
	Portland				✓		
	Sacramento		✓	✓			
	San Diego					✓	
	Santa Clara				✓		
Toronto						✓	
Low/High	Buffalo		✓				
	Pittsburgh	✓					
	San Francisco	✓	✓				✓
High Platform	Calgary	✓					
	Edmonton	✓					
	Los Angeles (Blue)	✓					
	Philadelphia (Norristown)	✓					
	St. Louis	✓					

Figure 75. Existing North American LRT accessibility features.

SYSTEM CHARACTERISTICS

Fare Collection

An advantage of LF-LRVs is that boarding (from platforms and from street level) is at least as fast, and in some cases significantly faster, than for conventional LRVs. The use of a proof-of-payment (POP) fare collection system will support more rapid boarding since loading can take place through all open vehicle doors.

On the other hand, if fares are collected on-board, the boarding process will take longer. The station dwell time must include the time passengers take to pay fares (usually at a single location at the front of the vehicle adjacent to the operator). This arrangement would reduce some of the benefit that a LF-LRV could provide.

On-board farebox payment systems are currently in place on the following LRT systems:

- Boston (gates in the tunnel),
- Cleveland (gates in downtown terminal),
- Philadelphia,
- Pittsburgh (gates in the tunnel),
- San Francisco (gates in the tunnel), and
- Toronto (also POP).

OPERATIONS CHARACTERISTICS

There are four operations characteristics discussed in detail—consist length, fleet size and system size, station spacing and system size, and operation in mixed traffic on city streets.

Consist Length

Systems that currently operate multiple car consists have the option of mixing LF-LRVs and conventional high-floor LRVs, or even creating married low-floor/high-floor pairs. Systems designed exclusively for single car consist operation may have more limited options and system constraints.

If an existing fleet that uses only single car consists is modified to include Category-1 vehicles, the increase in train length may require platform, signal, and other infrastructure modifications. Alternatively, the existing fleet could be retired in favor of LF-LRVs of the same dimensions.

The following systems currently run single car consists exclusively: Boston (Mattapan), Newark, Philadelphia (City Transit, Norristown), Pittsburgh (PCC routes), and Toronto.

Some systems currently running single car consists can operate with multiple car consists. Actual infrastructure modification requirements must be assessed on a case-by-case basis.

Fleet Size and System Size

LRT fleet and system sizes are also factors to consider in the applicability of low-floor vehicles. Systems that have large fleets operating on numerous lines will have more opportunities to implement LF-LRVs as part of an overall fleet replacement strategy. For example, such an agency could replace retired conventional LRVs with LF-LRVs on one line of its network and consolidate the balance of its conventional LRVs on other lines. A gradual strategy could be used to replace the entire fleet a portion at a time.

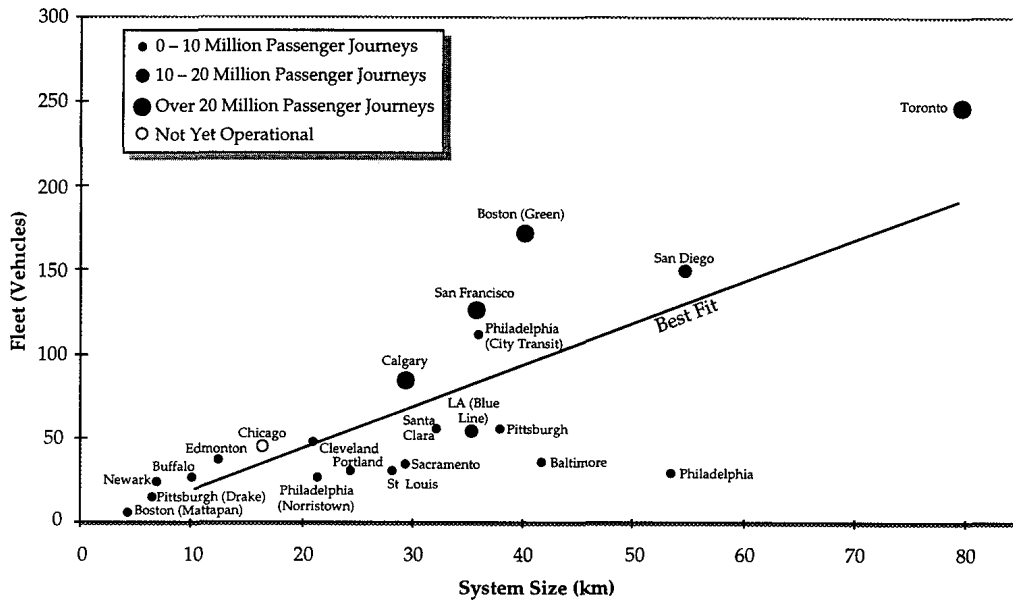


Figure 76. Fleet, system size, and ridership comparisons.

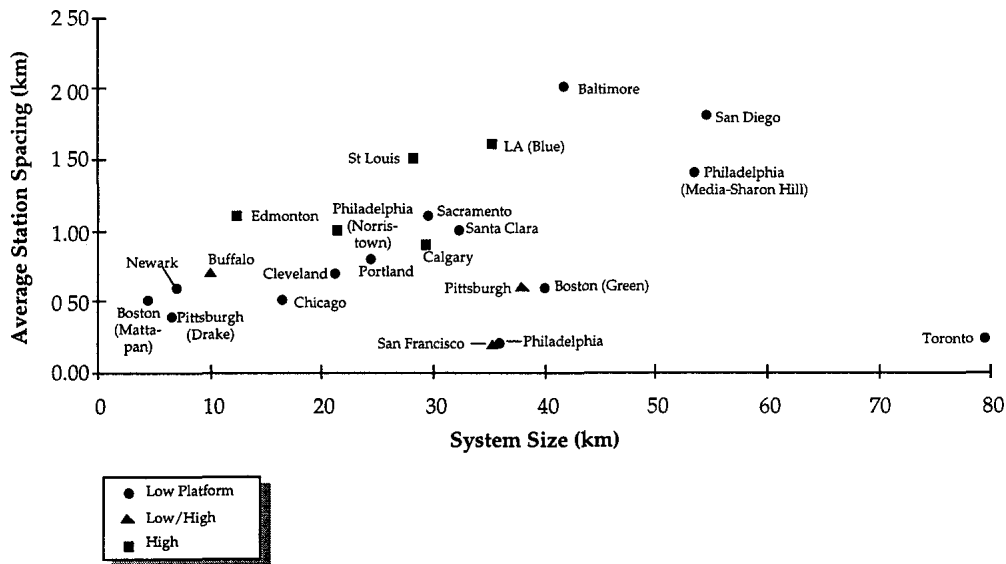


Figure 77. Station spacing and system size comparisons.

Figure 76 shows fleet size, system size, and annual ridership levels for the LRT systems in our survey.

Station Spacing and System Size

Systems with close station spacings save a larger proportion of their round-trip time by reducing station dwell times. Also, longer systems have longer round-trip times. If a train round-trip time can be reduced by the equivalent of a headway, the same level of service can be provided with one less train.

Figure 77 shows the LRT systems classified by average station spacing and system size. Note that the systems at the

bottom of the graph are better positioned to take advantage of round-trip time savings.

The following systems have an average station spacing of less than one kilometer (0.6 miles), where application of LF-LRVs has potential for significant round-trip time savings:

- Boston,
- Buffalo,
- Calgary,
- Chicago,
- Cleveland,
- Newark,
- Philadelphia,
- Pittsburgh,
- Portland,
- San Francisco, and
- Toronto.

Current European LF-LRVs are usually powered for a maximum speed of 70 km/h (44 mph), compared to North American systems with maximum speeds usually between 80 and 100 km/h (50 and 62 mph). Where station spacing is small, top speed is of minor importance because vehicles may never attain top speed. Where stations are spaced further apart, maximum speed is more important, and improvements to vehicles to increase top speed may be warranted.

Operation in Mixed Traffic on City Streets

Unless precluded by clearance constraints or track geometry, LF-LRVs will be attractive to North American LRT systems that currently operate streetcars and have a significant proportion of their route shared with automobile traffic. Such systems

will usually have locations at which there are no curbs or low curbs that cannot be raised. To meet ADA compliance requirements, telescoping ramps or lifts will be necessary. Systems that fit these criteria are in Philadelphia and Toronto.

VEHICLE CHARACTERISTICS

Axles

The basic unit for creating a Category-1 LF-LRV is a six-axle articulated conventional LRV. A Category-1 vehicle is created by adding a body section and an articulation unit to the basic unit. The following agencies use four-axle non-articulated LRVs that cannot be adapted to Category-1 vehicles: Buffalo, Boston (Mattapan), Newark, Philadelphia, Pittsburgh (PCC routes), Toronto (CLRV), and Toronto (Harbourfront LRT).

CHAPTER 5

APPLICABILITY FRAMEWORK ASSESSMENT MODEL

The recent availability of reliable and cost-effective low-floor light rail vehicles (LF-LRVs) presents a new range of system development options to North American LRT agencies. In some applications, there may be significant advantages in implementing a LF-LRV strategy. However, the addition of new options also makes the selection of the best strategy much more complex.

In order to aid in the selection of the best strategy, we have defined an applicability framework assessment model (Figure 78). The model demonstrates a process that can be used to define a range of options, then narrow the options to those best suited to a particular transit agency. As a complement to the model, comments in this chapter advise what are the major LF-LRV versus conventional LRV issues, what trade-offs will arise, and what are the most important discriminators between conventional LRVs and LF-LRVs. Information on LF-LRVs (Chapter 2), vehicle application issues (Chapter 3) and North American LRT system characteristics (Chapter 4) are discussed both individually and collectively.

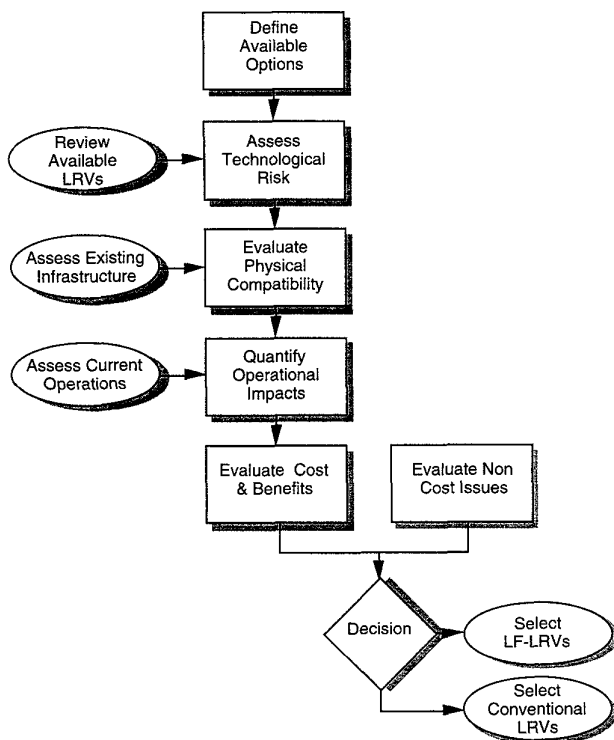


Figure 78. Applicability assessment model.

While we can highlight issues that will be of importance in assessing the applicability of conventional LRV versus LF-LRV solutions, each agency will have to look at the specific detailed requirements of its own system in determining its optimal course of action. Research conducted for this assignment has shown that North American transit agencies operate quite differently from each other and have widely varying system characteristics. Best solutions for each transit agency will also vary significantly.

LF-LRV designs are still evolving in Europe and North America. Because of differences in expectations of the traveling public, legislated requirements, and transit agency characteristics, it is possible and even likely that LF-LRVs in North America will look significantly different than their counterparts elsewhere. Many of the shortcomings of foreign LF-LRVs can be engineered out to provide a vehicle that is much better suited to North American practices and requirements.

The next sections of this chapter discuss the seven steps shown in the applicability assessment model:

- Define available options,
- Assess technological risk,
- Evaluate physical compatibility,
- Quantify operational impacts,
- Evaluate costs and benefits,
- Evaluate noncost issues, and
- Make a decision.

DEFINE AVAILABLE OPTIONS

A first step in selecting the best available options is to define the full range of feasible options. Once the feasible options have been established, a process of elimination can be used to short-list competitive options.

It is important to note that the LRT system option that scores highest from a cost/benefit perspective may not necessarily be the best option. Therefore, it is important to define a range of options that will find competitive solutions, not a single solution. Noncost issues often play a determining factor in the final selection process.

The key issues to be considered by a transit agency in evaluating options will vary, depending on the transit agency's situation and circumstances. For example, issues relating to development of a new line will differ substantially from issues relating to fleet replacement on an existing line. In general terms, an agency will be considering LF-LRVs from one of four perspectives:

- A new line is being developed;

- An existing line is being extended;
- Additional vehicles are being procured to add to fleet size or to replace retired vehicles; or
- The present system does not provide a satisfactory degree of barrier-free access to the traveling public (ADA compliance).

For each of these situations, a strategy and key issues are described in the following paragraphs. Within each of these situations, all existing systems are assumed to be operating conventional LRVs because presently no North American LRT system is operating LF-LRVs.

New Line

Situation. Construction of the first LRT line in a municipality, or construction of a separate (possibly overlapping) line as a complement to an existing LRT line(s).

Strategy. Consider LF-LRV solutions versus conventional LRV solutions, each with appropriate platform, maintenance shops, right of way, systems, and other interfaces developed to match the vehicle selection.

Key Issues. Key issues to consider include

- Reduced cost to install platforms for LF-LRVs compared to conventional LRVs;
- Improved ADA access may increase schedule reliability;
- Possible reduced fleet requirements with LF-LRVs (if boarding is faster); and
- Acceptance of the new system by the communities served and the traveling public (accessibility and aesthetics).

Line Extension

Situation. Extension of an existing LRT line.

Strategy. Add conventional LRVs to the fleet, modify existing fleet (i.e., Category-1 vehicles), or add LF-LRVs to the fleet.

Key Issues. Key issues to consider include

- Fleet uniformity versus mixed-fleet operations and maintenance;
- Lead time to modify existing fleet (with Category-1 LF-LRVs);
- ADA compliance and possible increased schedule reliability;
- Cost to retrofit existing infrastructure versus cost of new construction;
- Possible reduced fleet requirements with LF-LRVs (if boarding is faster); and
- Acceptance of the new extension by the communities served and the traveling public (accessibility and aesthetics).

Fleet Procurement

Situation. Increased fleet requirements necessitate procurement of additional vehicles, or some or all of the existing LRT fleet is aging and must be replaced.

Strategy. Procure replacement vehicles similar to existing vehicles to match infrastructure versus procurement of compatible or replacement LF-LRVs.

Key Issues. Key issues to consider include

- Fleet modification versus fleet replacement and/or addition to fleet;
- Lead time to modify existing fleet (with Category-1 LF-LRVs);
- Fleet uniformity versus mixed-fleet operations and maintenance;
- ADA compliance and possible increased schedule reliability with LF-LRVs;
- Possible reduced fleet requirements with LF-LRVs (if boarding is faster);
- Cost to retrofit existing infrastructure if LF-LRVs are used; and
- Acceptance of the new fleet and service by the traveling public (accessibility and aesthetics).

Barrier-Free Accessibility

Situation. The existing fleet and physical infrastructure are performing satisfactorily except that accessibility to the public is not barrier free and/or does not meet ADA compliance requirements.

Strategy. Modification of existing infrastructure or vehicles, or addition/replacement of conventional LRVs with LF-LRVs.

Key Issues. Key issues to consider include

- Cost to retrofit or modify existing fleet versus modification of infrastructure and/or addition of LF-LRVs to fleet;
- Fleet uniformity versus mixed-fleet operations and maintenance;
- Possible increased schedule reliability with LF-LRVs;
- Possible reduced fleet requirements with LF-LRVs (if boarding is faster); and
- Acceptance of the service by the traveling public (accessibility).

ASSESS TECHNOLOGICAL RISK

North American transit agencies have traditionally preferred using revenue service-proven equipment. This preference provides a basis for narrowing the choice of applicable LF-LRVs by eliminating some of the higher risk technologies that have emerged.

TABLE 11 Summary of LF-LRV Orders To Date

Category	Orders Greater than One Car	Fleet Order Range	Avg. Order (cars)	First Car Delivery
1	12	10-45	21	1987-93
2	33	4-120	28	1984-95
3	16	3-100	34	1990-95

Risk Evaluation

A proven and reliable operating history is a key consideration in assessing the risk associated with vehicle selection. Actual fleet performance during a number of years demonstrates what operating costs, maintenance costs, and fleet reliability should be achievable. While considerable data are available for conventional LRVs, the data for LF-LRVs are relatively limited. Table 11 summarizes the history of LF-LRV orders to date. In all cases, the mode average year (the year in which most orders were made) was 1993. This reflects the recent trend towards low-floor technology in the industry for all categories of LF-LRVs. For illustrative purposes, we have adopted a "proven equipment" criterion based on equipment that has been in service for more than 3 years and in fleets of 15 or more vehicles.

Category-1 vehicles make use of existing, proven technology and only include the addition of a center section, additional truck, and additional articulation. The Basel, Switzerland system has been in operation since 1987. Category-2 vehicles have now been in operation for as many as 10 years, and there have been six large orders placed prior to 1991. For Category-3 vehicles, the situation is somewhat different. There are only two Category-3 LF-LRV orders prior to 1991, one to Bremen and one to Munich in Germany. The remainder of the orders are for 1993, 1994, and beyond.

Category-1 and Category-2 vehicles make use of technology that has already been largely proven on similar high-floor vehicles. There are some innovations, such as small wheel trucks, that are substantially different than on conventional LRVs. Most of these innovations have also proved to be reliable, based on experience at a number of transit agencies. Therefore, the use of Category-1 and Category-2 technologies has little associated risk:

- All Category-1 vehicles could be applicable if they are found to be physically compatible.
- Within Category 2, all three types of running gear technology meet the defined proven equipment criterion and should be considered applicable:
 - Small wheel trailer truck technology (Geneva, St. Etienne)
 - Four independently rotating wheel truck technology, with or without cranked axles (Grenoble, Turin, Rome)
 - EEF wheelsets (Kassel).

For Category-3 vehicles, the technology is still evolving.

Vehicles incorporate unusual technological innovations, such as wheels that steer independently, and suspension systems with significantly reduced damping. Extremely limited service history is available for Category-3 vehicles. Using the illustrative "proven equipment criterion" defined above, the only vehicle applicable for use is the AEG (MAN) GT6N/8N. This vehicle operates in Bremen and Munich. In addition to price and other criteria used in selecting the best vehicle, risk should be considered carefully if Category-3 vehicles are being considered.

Mitigating Factors

While risk is an important factor, there are other factors that might make an agency accept higher levels of risk. For example, these issues might include

- More effective fleet use, thereby reducing fleet requirements and cost (i.e., a longer Category-3 vehicle might serve in place of two conventional-length Category-2 vehicles);
- Added passenger benefits (all entry doors are at a low-floor level);
- Participation in the development of cutting-edge solutions; and
- Local incentives such as employment or factors tied to vehicle supply.

EVALUATE PHYSICAL COMPATIBILITY

Relevant issues include the compatibility of new LF-LRVs to existing LRVs, to platforms, to maintenance shops and yards, to right-of-way elements, and to LRT systems elements.

LRV-to-LRV Compatibility

Vehicle-to-vehicle compatibility is especially important when new and existing vehicles operate in mixed consists. Approximately two-thirds of North American transit systems use multiple-car consists. Category-1 and Category-2 LF-LRVs have, by definition, conventional motored trucks. Accordingly, couplers (and anticlimbers) on these vehicles can match those on conventional LRVs. Acceleration, speed control, and braking rates will have to be matched for both types of vehicles. These issues are also relevant to coupling old and new LRVs together.

With respect to buff load and safety in case of a collision, vehicle compatibility is also important even if vehicles never couple but merely operate on the same line. Given that the floor of a Category-3 vehicle is lower than that on a conventional LRV, the natural location for the coupler, and the longitudinal load path through the vehicle (in case of collision), will be at a lower level. At present, no Category-3 LF-LRVs have been manufactured to operate as part of a mixed consist or to meet North American buff load requirements. To do so, would require redesign and additional manufacturing costs.

LRV-to-Platform Compatibility

Improved accessibility is a major reason for selecting LF-LRVs. Careful attention to the platform/LRV interface is necessary to ensure that accessibility is not lost.

ADA compliance requirements are described in Chapter 3. If platforms are to be installed to facilitate level boarding, it will be important that close attention be paid to design and construction tolerances. It is also likely that load leveling will be required on cars to compensate for changing load conditions. Horizontal separation between the car and platform will also have to be monitored closely. Fold-down bridgeplates have been used successfully to reduce or close the gap between cars and platforms. Placement of platforms on curves will be problematic because the in-swing and out-swing of vehicles will affect platform placement. While bridgeplates can accommodate small vertical gaps and horizontal gaps of up to 100 mm (4 in), larger gaps would likely require more sophisticated solutions such as the use of extendable ramps. This will create additional problems. While fold-down bridgeplates can deploy in a second, extendable ramps might easily take several seconds or longer.

If high platforms already exist, it would be necessary to remove the platforms to allow boarding of LF-LRVs. Alternatively, in some cases it may be possible to locate high- and low-stop locations in tandem. This would be a feasible solution where complementary conventional and LF-LRV service is provided, for example, from different lines.

If low platforms are added to an LRT system where conventional high-floor LRVs are presently boarded from street level, care should be taken to ensure that it is not necessary to step down to the first step of conventional high-floor cars. This can be achieved by careful selection of the platform height or modification of the steps on the high-floor cars.

Other means by which wheelchair boarding of LF-LRVs can be provided for is through the use of carborne lifts, wayside lifts, and extendable ramps.

LRV-to-Maintenance Shops and Yard Compatibility

Most LRT systems use vehicles that can operate interchangeably. If mixed fleets are used, adequacy of the yard to support storage and accessibility of both conventional and LF-LRVs should be checked. If LF-LRVs and conventional LRVs are to operate within the same consists, consideration must also be given to make-up and breakdown of consists, storage of ready spare consists, and the ability to make and store consists in the correct car order.

Maintenance shop requirements for LF-LRVs will differ slightly from those for conventional LRVs. On conventional LRVs, many of the components are located under the vehicle; on LF-LRVs, many of these components are located on the roof. Therefore, the need for underfloor pits is reduced, but in place of that there is a need for roof-level platforms. This difference will affect crane access to the sides of the cars, and introduce new safety elements as a result of work taking place adjacent to the power distribution system and increased risk of maintenance staff falling (from the top of vehicles).

Other things to consider in the maintenance shop include lengths of work areas, such as pits and paint booths. Category-1 vehicles are typically longer than conventional LRVs. In-floor jacks, installed for work on conventional LRVs, will likely be in the wrong place for LF-LRVs. Jacking vehicles and raising LF-LRVs by crane will also be complicated if the vehicles have extra body and articulation sections.

LRV-to-Right-of-Way Compatibility

The new train consist (single or multiple car) must clear all civil elements in the right of way. For example, there must be clearance for the running gear and the vehicle underbody along the entire LRT system length. Projection of any equipment above TOR elevation should be carefully assessed.

The LF-LRV must be able to negotiate all curves along the right of way and have sufficient power and traction to climb the steepest grades. (See more discussion of this in Chapter 3 and Chapter 4.)

The specific mass of LF-LRVs is usually equal to or slightly less than that for conventional LRVs. Accordingly, no changes should be required to existing structures or support elements.

LRV-to-LRT Systems Compatibility

LRT systems include signals, communications (wayside), traction power, and fare collection.

Signals (train control) will normally only be an issue if train lengths have changed. If train lengths do change, this might require that stopping locations of trains be changed or even that different station stop locations be used.

Except in the case of relocation of stations or other necessary changes in infrastructure, communications will not usually pose compatibility problems.

Traction power will be only slightly affected by the use of LF-LRVs. Acceleration and performance of conventional and LF-LRVs is similar. On average, Category-1 and Category-2 LF-LRVs have a slightly lower specific mass than conventional LRVs, so a marginal savings in power costs should be anticipated. Category-3 LF-LRVs, on average, will provide even greater savings.

QUANTIFY OPERATIONAL IMPACTS

LF-LRVs were developed with the objective of enhancing passenger accessibility. As a direct consequence of this, the efficiency of LRT operations has been improved because of more rapid boarding of vehicles. Enhanced accessibility also means that the system can serve a broader range of customers and could gain new riders.

On new lines, LRT infrastructure can be developed to fully complement the use of LF-LRVs. In other situations (such as the extension of existing lines, the procurement of additional fleet vehicles, and conversions to meet ADA compliance requirements) it may be difficult to implement LF-LRV solutions. Problems may arise with compatibility between new vehicles

and existing infrastructure and operations. Where LF-LRV solutions are implemented, the full benefit of the use of LF-LRVs may or may not be realized.

Issues relevant to the operation of LF-LRVs include the following:

- ADA compliance,
- Schedule reliability,
- Fleet requirements,
- Passenger demand,
- Vehicle performance,
- Mixed-fleet operations,
- Fleet maintenance, and
- Adverse climatic conditions.

ADA Compliance

In addition to the fact that it is desirable that LRT systems provide barrier-free accessibility to passengers, it is necessary that American LRT systems comply with ADA requirements. Most accessibility options are the same for LF-LRVs and conventional LRVs. These include the installation of platforms (to allow level boarding), carborne lifts, and wayside lifts. Another option available for use with LF-LRVs is the use of extendable ramps to allow boarding from curb-level stops.

Where the same method of wheelchair boarding is used on conventional LRVs and LF-LRVs, there is negligible difference in boarding times. For example, whether boarding a conventional high-floor LRV or a LF-LRV using a carborne lift, the time impact on operations will be nearly the same.

Schedule Reliability

A significant gain in operational reliability and reduced dwell time can be achieved through the use of LF-LRVs. Typical dwells at an LRT station where there is level boarding from a platform may vary from approximately 8 sec in very light load situations to 20+ sec in very heavy load situations. In contrast, a single wheelchair boarding or alighting via a wayside or carborne lift usually takes 2 to 4 min—depending on the mechanical system and procedure used and assuming that no problems arise. The use of extendable ramps takes approximately the same length of time.

On some LRT systems, train headways are small and many persons in wheelchairs ride the system. In a case where a single train has two wheelchair boardings and alightings in each direction of its round trip (assuming 3 min per boarding or alighting), its round-trip travel time would increase by 12 min. Peak-hour headways of 10 min or less are common. On a system with a peak-period train headway of 10 min, if no built-in allowance is made for wheelchair boarding, service delays will result in a complete train being lost from the schedule. If an allowance is made for boarding persons in wheelchairs, an extra train would have to be inserted in the schedule in case wheelchair boarding did take place. Even in the case where an allowance is made for one wheelchair boarding and alighting per trip, a second or third wheelchair boarding would

result in delays to schedule. If this situation occurred frequently, riders may perceive the service to be unreliable.

The use of LF-LRVs makes it significantly easier to install platforms to allow level boarding of LRVs. If level boarding can be provided, persons in wheelchairs could board unassisted within normal dwell times. This would have an extremely positive impact on schedule and fleet efficiency.

Fleet Requirements

Fleet requirements are a function of round-trip times, consist size, and required train headway. (Spares requirements have been ignored for simplicity.) Round-trip times include vehicle travel time, dwell time, layover time at the end of the line to allow the operator to switch vehicle ends, and schedule adherence time to allow for recovery from delays.

Cars required = (consist size X round-trip time) / train headway
and

Round-trip time = travel time + dwell time + layover time + schedule adherence.

Travel time is affected by vehicle performance (acceleration, braking, and maximum speed). European LF-LRVs often are specified with lower top speeds than North American vehicles. On systems with close station spacing and in-street running, this is not important. Where station spacing is larger, it would be prudent to increase motor power to provide improved performance. At a certain point, performance for any vehicle type will be limited by passenger comfort during acceleration and deceleration. In most cases, however, the difference between LF-LRV and conventional LRV travel times will be negligible.

Dwell times are significantly affected by car accessibility. We have already discussed the potential benefits of using LF-LRVs from the perspective of wheelchair boarding. While a wheelchair passenger can board from a level platform within a normal station stop time, an additional 2 to 4 min is required for each entry and exit using lifts. Gains can also be achieved for boarding of other passengers. It takes longer for a passenger boarding a train to climb 3 steps (conventional high-floor LRV) than to climb 1 step (LF-LRV). Observations indicate that equivalent dwell times of 24 sec, 14 sec and 10 sec would apply to boardings with 3 steps, 1 step, and level boarding, respectively. Similar proportions would apply for lighter and heavier boardings.

Layover time is unrelated to the use of conventional LRVs or LF-LRVs. Schedule adherence may be an issue if the LRT operation is prone to passenger-boarding delays, as is potentially the case with boardings by persons in wheelchairs. This issue has been discussed previously in the section on schedule reliability.

Passenger Demand

There are a number of reasons to anticipate some increases in ridership as a result of deployment of LF-LRVs. It is much easier to mount a single step to board a vehicle than to climb several steps. This is an important matter for many passengers

including the aged or mobility impaired (those who can walk but with some difficulty or who use mobility devices). The provision of level boarding would be even better. It would facilitate easy boarding of wheelchairs, baby strollers, and passengers carrying bags. It is common in European cities to see public transportation systems heavily used by passengers with children and shoppers during off-peak periods. The potential for increases in ridership will vary tremendously depending on the land-use characteristics of the area served by the LRT system (e.g., shopping areas, dense residential areas).

A secondary benefit of the use of LF-LRVs can accrue from the limited impact of low platforms on the environment compared to high platforms. The area around the station can be used to improve the appeal and aesthetics of the destination, rather than merely serving as the area on which a platform is located.

Mixed-Fleet Operations

From an operations perspective, it is easiest to deal with a fleet in which all cars are similar. Any single failed car could then be replaced by any other available car. The mixing of LF-LRVs and conventional LRVs complicates operations.

If consists are mixed, as might be required to meet ADA compliance (one car per train rule), then the order of vehicles in the consist could become important, and/or the stopping location of the first car will vary depending on the car type. Failure of the only ADA-compliant car in a consist would require replacement with a like car. This will have an impact on the fleet's vehicle spare ratio requirements.

If the fleet is mixed, but consists are not, this will have a significantly smaller impact on operations. Additional effort will be required in scheduling and deployment of vehicles to ensure that vehicles start and end service each day at appropriate locations.

Fleet Maintenance

Experience to date suggests that there is no significant premium or savings in the maintenance of (Category 1 or Category 2) LF-LRVs versus conventional LRVs. Due to the use of novel technology in Category-3 vehicles, maintenance of those vehicles is expected to cost more, but there are presently insufficient data to quantify the cost premium.

The maintenance of a mixed LF-LRV and conventional LRV fleet will require additional inventory, staff training, and other inputs to ensure that staff can deal with the two different types of cars. This requirement will be similar to the situation where existing and replacement conventional LRVs are slightly different. Accordingly, this issue appears to be of minor importance.

A more serious matter relates to the maintenance facilities to be used. Major issues to be addressed include the following:

- Are the new vehicles longer than existing vehicles? If so, are pits, paint booths, and work areas large enough to accommodate the longer vehicles?
- If there are in-floor jacks in the facility, can they accom-

modate the new vehicles or be easily modified to do so? The additional articulations on Category-1 and Category-3 vehicles complicate jacking procedures.

- If large overhead cranes are used to lift car bodies for truck removal, is there sufficient crane capacity to allow lifting of the LF-LRV car bodies (particularly if there are more body sections)?

There are also some minor issues that should be considered. Many of the components found under conventional LRVs are placed on the roof of LF-LRVs. Therefore, raised (roof-level) platforms will be required to support the maintenance of LF-LRVs. This will complicate crane access to the car sides. Also, with work being conducted at car roof levels, work must be conducted in close proximity to the traction power distribution system. Extra precautions must be taken to prevent accidental injury of workers both from the power system and from falls.

Facilities can be established to support efficiently the maintenance of LF-LRVs and to support conventional LRVs. The requirement for a facility to support maintenance of both types of vehicles may result in some losses in efficiency. Individual assessment of facilities and maintenance strategies would be required to quantify impacts.

Adverse Climatic Conditions

LF-LRVs have lower underbody sections than conventional high-floor LRVs. In areas with heavy snow accumulation, clearing of snow from the right of way may be necessary to prevent snow from compacting under cars. With conventional LRVs, snow clearing is not necessary except in the most extreme circumstances.

EVALUATE COSTS AND BENEFITS

A cost/benefit analysis can be applied to each feasible option to determine the merit of that option relative to others and to assess the financial practicality of any option. Our analysis and discussion concentrates on the relative merit of LF-LRV versus conventional LRV solutions. Capital and operating costs are considered.

Capital Costs

Platforms for LF-LRVs will usually cost significantly less than high platforms for conventional LRVs. In many cases a low platform could be constructed as a raised sidewalk with a high curb. Because of the significantly reduced scale of LF-LRV platforms, landscaping and other aesthetic treatments sometimes necessary with high platforms can be reduced or eliminated. One of the most significant benefits regarding the use of LF-LRVs is that it is much easier to install low platforms to allow level boarding than it is to install high platforms for conventional LRVs. Costs of low platforms are less, and impacts and intrusion of the platform on the surroundings are

also significantly reduced. Accordingly, low platforms can be installed in at least some areas where high platforms cannot.

Representative vehicle costs are shown in Chapter 2. Recent conventional LRV procurement costs for DART in Dallas and MUNI in San Francisco are \$2.1 million and \$2.2 million, respectively. Category-2 vehicle costs are expected to range from approximately +0 percent to +10 percent more than comparable conventional LRV prices. As the number of LF-LRV orders increases, it is anticipated that no premium cost will apply to LF-LRVs. Conversion costs to turn a conventional LRV into a Category-1 LF-LRV are estimated to be 30 percent of the cost of a new vehicle. Category-3 vehicles typically cost more than Category-2 vehicles. Because the technology and size of Category-3 vehicles vary widely, there will be a correspondingly wide range in prices.

Retrofit of existing infrastructure and systems may be necessary if LF-LRVs are applied to a system originally constructed to operate conventional LRVs. Platforms may have to be modified to match low door-sill heights. Yards and maintenance shops will likely require modification to accommodate roof-mounted equipment. In some cases, it may also be necessary to revise elements of the right of way, such as curve radii, although this would usually not be necessary. Retrofit will probably be unnecessary or of minor consequence for fare collection, traction power, and signaling systems. An exception would be the case where consist lengths increased, thereby necessitating revisions to stop locations and signal systems.

Opportunity cost should also be considered, although in some cases costs or benefits may not directly affect the agency. For example, consider the development of a new LRT system through a central business district (CBD) within a four-lane roadway with wide sidewalks. A high-platform solution would require use of two lanes for trains, two lanes for platforms, and sidewalks to allow passage by the platforms. Conversely, a LF-LRV solution could entail the use of raised sidewalks, thereby leaving two unobstructed traffic lanes. The cost associated with the loss (or retention) of the two lanes will depend on the use of the lanes and other access through the CBD. Opportunity cost also relates to the loss of utility of LRVs during retrofit in the case of development of Category-1 LF-LRVs.

As a general comment, note that conventional high-floor LRV platforms and vehicles are well suited to line-haul operation where much of the LRT right of way is separated from other land uses. Station spacing will be relatively large on a line of this type, so the cost of platform development relative to other costs will be small. On the other hand, where station spacing is close, where stops are located in streets or in close proximity to residential or commercial uses, and

where aesthetics are important, there are considerable benefits to be gained in using LF-LRVs.

Operating Costs

Maintenance and operating costs for conventional LRVs versus LF-LRVs will vary depending on the low-floor vehicle technology used. In the event that a smaller LF-LRV fleet can be used because of faster boarding and therefore faster round-trip times, savings may be realized as a result of the reduced number of operations and maintenance staff required. Savings may also be available in energy consumption because LF-LRVs often weigh less than equivalent conventional LRVs.

EVALUATE NONCOST ISSUES

A number of LF-LRV benefits are difficult to quantify in dollar terms. Improved accessibility of the system will better serve the elderly and mobility-impaired. Use of low platforms instead of high platforms can significantly reduce the impact of an LRT system on the streetscape, making the street more friendly to commercial and pedestrian uses. Relevant issues may include the following:

- Vitality of the CBD core and other areas served by the LRT system,
- Quality of service,
- Aesthetics,
- Acceptance of the LRT system by the public and passengers,
- Time savings by users, and
- Safety (easier egress from vehicles stopped on the wayside in case of emergency).

SELECT THE BEST OPTION

Final selection of the best option will require the careful evaluation and assessment of cost and noncost issues. While on one hand it is extremely important that transportation agencies operate efficiently, it is also important that the agencies meet the expectations of the public and municipalities they serve. Weighing cost versus noncost issues is never easy. LF-LRV options provide new opportunities to meet multiple objectives that, in the past, might have been considered to be mutually exclusive.

A process that can be used to select competitive options has been described in Figure 78. In the next chapter, two examples are provided to demonstrate and clarify issues to be addressed.

CHAPTER 6

CASE STUDIES

Two illustrative examples have been developed to show, in a realistic North American context, issues and trade-offs relevant to the choice of low-floor light rail vehicles (LF-LRVs) versus conventional LRV options:

- Case Study 1—An extension to an existing low-platform LRT system; and
- Case Study 2—A new LRT system.

Minor changes in assumptions or LRT system characteristics will have a significant impact on which technology is most cost-effective. Furthermore, in Europe the move to LF-LRV implementation has been driven not by cost, but by service to the public. Whether or not costs indicate a LF-LRV or conventional LRV solution is best, other issues probably will have a major impact on the decision-making process.

CASE STUDY 1

The transit authority owns a fleet of conventional LRVs that meet present demand on the existing line. Characteristics for the existing line and fleet are defined in Table 12 and Table 13. An extension is planned that will increase the line length from 12.9 km (8 mi) to 32.2 km (20 mi). It is estimated that 69 LRVs will be required for the extended line. The extended line characteristics are defined in Table 14.

One major operating concern is that delays occur because of the frequent but randomly occurring boarding of persons in wheelchairs. The stations are equipped with lifts that bring persons in wheelchairs onto the vehicle via the side door, located just behind the operator. Loading wheelchairs involves stopping the vehicle so the appropriate side door properly aligns with the wayside lift; enabling, then raising the lift; and finally lowering and storing the lift. In many cases, passengers need assistance entering and exiting the lift because the lift is only slightly larger than the wheelchair. This process extends normal station dwell by 2 to 4 min. Usually there are no more than two wheelchair loadings and unloadings per round trip. With two boardings and alightings, trains can be delayed approximately 10 min per round trip on average.

The transit authority now wants to evaluate the costs and benefits of conventional LRV and LF-LRV procurement options. In both circumstances, new vehicles should closely match specifications for the existing vehicles.

OPTIONS AVAILABLE FOR CONSIDERATION

The transit authority has selected four options for consideration:

1. Purchase additional conventional LRVs, build appropriate and compatible infrastructure on the new extension;
2. Purchase additional conventional LRVs, retrofit all vehicles to make low-floor (Category-1 vehicles), retrofit existing line infrastructure;
3. Purchase LF-LRVs, retire existing fleet, retrofit existing line infrastructure; and

TABLE 12 Low-platform LRT system extension case study—characteristics of existing line

One-way line length	12.9 km (7.8 miles)
Stations	
• Number	14
• Average spacing	0.92 km (0.57 miles)
• Platform height above TOR (with LRVs)	152 mm (6 in)
• Platform length	61 m (200 ft)
• Wheelchair access	Wayside lift
Track parameters	
• Gauge	1,435 mm (4 ft 8.5 in)
• Minimum horizontal curve radius	25 m (82 ft)
• Maximum grade	6%
Performance using existing conventional LRVs	
• Average station dwell (no wheelchair)	18 sec
• Average round-trip speed	22.5 km/h (14 mph)
• Round-trip time	1 hr 9 min
Design peak-service headway	5 min
Design line capacity (crush)	3,500 pax/h/direction
No. of trains required to maintain headway	14
Vehicles/train	2
Number of conventional LRVs required, including 15% spares	33
Required vehicle crush capacity	145
Expected frequency of wheelchair patrons boarding each vehicle in peak-service hours	2 per round trip

TABLE 13 Low-platform LRT system extension case study—existing conventional LRV characteristics

Type: six-axle, single articulation, double ended	
Dimensions	
• Length (over couplers)	25 m (82 ft)
• Width	2.64 m (8 ft 8 in)
• Height	3.35 m (11 ft)
• Floor height	965 mm (38 in)
• Number of steps	2 (on vehicle)
• Step height	267 mm (10.5 in)
• Coupler height	559 mm (22 in)
Buff strength	2 x vehicle weigh
Performance	
• Maximum speed	80 km/h (50 mph)
• Initial acceleration	1.3 m/s ² (2.9 mph/sec)
• Service brake rate	1.3 m/s ² (2.9 mph/sec)
Wheelchair access	Wayside lift
Air comfort system	Roof-mounted HVAC
Year of acquisition	1987
Unit purchase price	\$1,092, 000

4. Purchase LF-LRVs to operate in mixed consists with existing fleet, retrofit existing line infrastructure.

In this example, the applicability assessment model is used to assist in finding the best option. In an actual analysis, suboptions such as high platforms versus ramps or lifts, would also need to be examined.

TECHNOLOGICAL RISK ASSESSMENT

New vehicles are required in as short a time as possible. The transit authority is therefore strongly inclined to choose proven equipment that has a history of satisfactory service performance. It has decided to impose proven equipment criteria, which require any major subsystem to have been operating in revenue service for at least 3 years (by mid-1995 when the contract will be signed) demonstrated with a fleet of 20 or more vehicles. Consequently, the list of acceptable designs is narrowed down to the vehicles/technologies listed in Table 15. The table shows that several low-floor designs meet the "proven equipment" criteria; however, all of these utilize conventional power trucks. The transit authority will not consider any Category-3 LF-LRVs.

PHYSICAL COMPATIBILITY EVALUATION

The transit authority must now evaluate five areas of physical compatibility—vehicle-to-vehicle, vehicle-to-right of way, ve-

TABLE 14 Low-platform LRT system extension case study—characteristics of new line

One-way line length	32.2 km (20 miles)
Stations	
• Number	28
• Average spacing	1.1 km (0.7 miles)
Track parameters	
• Gauge	1435 mm (4 ft 8 5/8 in)
• Minimum horizontal curve radius	25 m (82 ft)
• Maximum grade	6%
Performance using existing conventional LRVs	
• Average station dwell (no wheelchair)	18 sec
• Average round-trip speed	25.8 km/h (16 mph)
• Round-trip time	2 hr 30 min
Design peak service headway	5 min
Design line capacity (crush)	5,000 pax/h/direction
No. of trains required to maintain headway	30
Vehicles/train	2
Number of LRVs required, including 15% spares	69
Required vehicle crush capacity	208
Expected frequency of wheelchair patrons boarding each vehicle in peak service hours	2 per round trip

hicle-to-platform, vehicle-to-maintenance facility, and vehicle-to-systems.

Vehicle-to-Vehicle Compatibility

Coupling. To maximize operating flexibility, comply with ADA requirements, and provide maximum access to the disabled on both the existing line and new extension, the new LRVs must be capable of coupling with existing vehicles.

Except for the original vehicle manufacturer, all suppliers would require design modifications to ensure coupler and train-line compatibility with the existing vehicles. The engineering required would be greater for any vehicle type that has not previously coupled at the conventional 559 mm (22 in) height.

Buff Load. If the chosen LRV has not been in service in North America, then the manufacturer will have to re-engineer

TABLE 15 Low-platform LRT system extension case study—low-floor vehicles; proven equipment criteria

Category	City	Manufacturer	Type	% LF	No. in Order	Year	Power Truck	Trailing Truck
1	Mannheim	Duewag		8.9%	23	1991	Monomotor	Conventional two-axle
1	Amsterdam	Bombardier (BN)	11/12G	9%	45	1989	Bimotor	None
2	Rome	Socimi	T8000	54%	34	1990	Bimotor	Four independent wheels
2	Turin	Fiat (Firema)	5000	56%	54	1989	Monomotor	Four independent wheels
2	St. Etienne	GEC Alsthom	Be4/6	59%	25	1991	Monomotor	Small wheel
2	Geneva	ACM Vevey	Be4/6	60%	46	1984	Monomotor	Small wheel
2	Grenoble	GEC Alsthom	ZR 2000	65%	38	1987	Monomotor	Independent wheels on two cranked axles
2	Kassel	Duewag	NGT6C	70%	25	1990	Monomotor	EEF wheelset

the vehicle to meet the authority's required buff load strength (2 times the vehicle weight).

Vehicle-to-Right-of-Way Compatibility

The track structure, gauge, and horizontal and vertical alignment present no compatibility problems for any vehicle being considered. The maximum grade along the new and existing line is less than 6 percent; therefore, adhesion capability of LF-LRVs is not an issue.

Vehicle-to-Platform Compatibility

Platform Height. The transit authority paid particular attention to the aesthetics of existing line stations and installed pleasing curb-level platforms. Raising station platforms to allow level boarding of conventional LRVs is considered infeasible. In fact, the authority considered and rejected the idea of using high platforms in construction of the original line. The authority is considering two options for the stations, depending on the vehicle type purchased:

- **Conventional LRV.** Construct curb-level platforms at the new stations with wayside lifts to allow boarding for those with mobility restrictions.
- **LF-LRV.** Construct low-level platforms, essentially a raised curb, at the new stations. The existing vehicles have two steps, the bottom one being 432 mm (17 in) above TOR, when the vehicle is empty. All stations are on tangent track. The station platforms can therefore be constructed to 350 mm (14 in) above TOR to allow level boarding onto LF-LRVs. Passengers boarding the conventional vehicles would have an initial step, onto the

LRV, of 82 mm (3 in). The existing stations would have a new top course placed on top of the existing platforms, and rails and architectural features would be adjusted.

Platform Length. The platforms on the existing route, and those proposed for the extension, are 61 m (200 ft) long. Conventional LRVs and Category-2 LF-LRVs will be specified so that existing platform lengths are not exceeded. If the transit authority chooses to convert the existing six-axle LRV fleet to achieve a 10 percent to 15 percent low-floor area (i.e., develop Category-1 vehicles), this would increase each LRV's length by approximately 6 m (20 ft). This would require lengthening existing platforms. The stations are not near street intersections, so extensions are possible.

Vehicle-to-Maintenance Facility Compatibility

The transit authority's yard has surplus capacity that can handle the increased fleet size, but the existing maintenance facility will require expansion. Facility requirements for extra conventional LRVs will be different from those for LF-LRVs, but the facility cost is expected to be approximately the same for conventional and Category-2 vehicles. If Category-1 LRVs are used, some modification of the existing facility will be required to handle the increased car length.

Vehicle-to-Systems Compatibility

Signaling. Preliminary work by the transit authority's engineering department regarding safe braking distances suggests that Category-1 vehicles will not pose a safety problem, and changes to track circuits and signals will not be needed. How-

ever, more detailed tests will be required to verify this. There are no problems anticipated with the use of additional conventional LRVs or Category-2 LF-LRVs.

Power Consumption (as a function of mass). Some power savings should accrue from the use of LF-LRVs. European LF-LRVs have a specific mass approximately 10 percent lower than conventional LRVs, on average. Bringing the vehicles to North American buff load specification will increase the vehicle specific mass by approximately 3 percent (based on Portland's experience). Therefore, the transit authority estimates a 7 percent mass reduction can be achieved. Taking into account system passenger loading and operating characteristics, a savings of 2.7 percent of traction power energy costs is expected.

Alternatively, the authority estimates that converting its entire fleet to Category-1 vehicles will result in a running fleet mass that is 18 percent higher (25% longer, 10% lighter, 3% buff load penalty) but with increased vehicle capacity. Premium energy costs are estimated at 7 percent.

Fare Collection. The existing POP system will not be affected by the vehicle type.

OPERATIONAL IMPACT QUANTIFICATION

Vehicle Performance

The new vehicle must match existing performance standards. If a European LRV is selected, improvements to the propulsion system will be required.

Round-Trip Time

The authority currently uses 14 trains on a 5-min headway during peak hours. Wheelchair boardings are common, and the boarding and alighting of two wheelchairs per train per round trip often results in service delays of 10 min. This is considered unacceptable by Operations. To accommodate this, an extra 10 min for schedule adherence will have to be built into the extended line schedule, if conventional LRVs are purchased. As a result, an additional two conventional LRV trains will be required to provide service during peak hours.

The authority expects that selection of LF-LRVs will result in reduced round-trip times and vehicle savings for the following reasons:

- Wheelchair boarding time can take place within normal station dwells since level boarding will be provided for; therefore, no additional vehicles will be needed to compensate for this.
- Boarding time onto the LF-LRV for all other passengers (especially the elderly and passengers with packages or pushing strollers) will be reduced. The peak consist will be a coupled conventional/low-floor train, so some passengers will still be boarding via the conventional LRV. The authority expects that the average station dwell

time will drop from 18 sec to 16 sec. The 2-sec reduction in station dwell times will add a buffer of approximately 2 min (over 56 station stops) to the running schedule.

Fleet Mix

The authority is counting on rapid wheelchair boarding and alighting of LF-LRVs. After careful consideration, Operations decided that low-floor boarding locations be clearly marked, and that trains consistently stop in the same location. Accordingly, vehicles will always operate with the LF-LRV in front on the inbound trip, and the conventional LRV in front on the outbound trip. When passenger demand drops off, LF-LRVs can be operated as single car consists. Cars will stop at LF-LRV boarding locations at these times.

Given that yard capacity is not a problem, the need to store both conventional LRV and LF-LRV operating spares on separate tracks and the need to break and make mixed consists is of minor significance.

Training

The transit authority will be hiring additional operations and maintenance staff for the line extension. Therefore, operations and maintenance training will be required regardless of the vehicle procured. The introduction of LF-LRVs would require more extensive training requirements.

COST ESTIMATION

Because the existing fleet was acquired 7 years ago and the procurement specification required a 25-year design life, the present LRVs should be operable for another 18 years. The cost of purchasing identical additional vehicles is estimated to be \$1,900,000 to \$2,200,000, so the retained value is high, but no potential buyer could be found who was willing to pay anything near that price for used vehicles. The service and reliability performance of the vehicles has been satisfactory and maintenance costs are about average for the industry. The authority therefore eliminates Option 3 from consideration, which was based on retirement of the existing fleet.

A first-cut estimate for the remaining three options is shown in Table 16. Note that the costs are provided for illustrative purposes only, and that the only price elements shown are those in which prices will vary by option.

NONCOST ISSUES

The line extension will serve an outlying suburban area. Residents and passengers have been vocal in expressing their expectations for the extension.

Aesthetics

Low- or no-platform stations are favored. Strong objections to the visual impact of high-platform stations adjacent to resi-

TABLE 16 First-cut cost estimate for remaining options

	CONVENTIONAL FLEET		CATEGORY-1 FLEET		MIXED HIGH/LOW FLEET	
Vehicles						
Per Vehicle Cost	\$2,200,000		\$2,200,000		\$2,200,000	
Low-Floor Design Premium	\$0		\$220,000		\$220,000	
Number of Vehicles	36		36		36	
Subtotal		\$79,200,000		\$87,120,000		\$87,120,000
Modify Existing Vehicles						
Per Vehicle Cost	\$0		\$550,000		\$0	
Number of Vehicles	0		33		0	
Subtotal		\$0		\$18,150,000		\$0
New Stations						
Curb-Level Platform	\$75,000		\$0		\$0	
Low-Level Platform	\$0		\$150,000		\$150,000	
Wayside Lift	\$50,000		\$0		\$0	
Number of New Stations	14		14		14	
Subtotal		\$1,750,000		\$2,100,000		\$2,100,000
Existing Stations Modification						
Raise Platform/Remove Lifts	\$0		\$100,000		\$100,000	
Adapt Platform to Longer Vehicles	\$0		\$50,000		\$0	
Number of Existing Stations	14		14		14	
Subtotal		\$0		\$2,100,000		\$1,400,000
Existing Maintenance Facility Modification	\$0	\$0	\$100,000	\$100,000	\$0	\$0
Safety Distance Testing Over Alignment	\$0	\$0	\$100,000	\$100,000	\$0	\$0
Training						
Operations	\$50,000		\$75,000		\$75,000	
Maintenance	\$50,000		\$100,000		\$100,000	
Subtotal		\$100,000		\$175,000		\$175,000
Additional Recurring Cost						
Power Consumption	\$0		\$0		(\$40,500)	
Minimum Vehicle Life (yr)	15		15		15	
Net Present Value (4%)		\$0		\$0		(\$450,295)
Schedule Reliability Capital Cost						
Four Additional Vehicles	\$8,800,000	\$8,800,000	\$0	\$0	\$0	\$0
Schedule Reliability Recurring Cost						
Operations (2 consists, 2 shifts)	\$160,000		\$0		\$0	
Maintenance (\$2 00 per mile)	\$83,200		\$0		\$0	
Expected Vehicle Life (yr.)	15		15		15	
Net Present Value (4%)		\$2,703,992		\$0		\$0
TOTAL ESTIMATED COST		\$92,553,992		\$110,745,000		\$90,344,705

dential areas were heard. A request for input on the possibility of raising existing platforms in the CBD area by 200 mm (8 in) was met with indifference. The general population was not bothered by the wayside lifts; most nonriders were unable to identify the lifts as such.

Meeting the Needs of Persons in Wheelchairs and Other Passengers

Persons in wheelchairs have expressed extreme concern about the use of wayside lifts for boarding. It takes 2.5 min

on average for one person in a wheelchair to board a train, while other passengers can board in seconds. Persons in wheelchairs feel self-conscious when using the system and say that it is unfair that their use of the system is often resented by other passengers.

Positive responses on the possibility of level boarding were also received from focus groups representing the elderly and those with limited ambulatory abilities (such as those with heart conditions, hip problems, etc.). The possibility of introducing level boarding was regarded as a tremendous step forward by all focus groups.

Impact on Businesses Along the Route

There are many businesses located near stations in the CBD area. While extremely concerned and resistant to the installation of high platforms, they had no objection to installing low platforms. The possibility of increased ridership was seen as a plus. The only remaining concern was that signage and shelters adjacent to stops should be located so that business signs and display windows remained clearly visible to passersby.

Project Objectives

There is an expectation of new ridership originating from the existing segment since new origin/destination pairs will be created. Current passenger complaints regarding schedule unreliability (as a result of delays from boarding persons in wheelchairs) are a serious concern. The authority wants improved schedule reliability.

THE NEXT STEPS

The next steps will include refinement of options and costs, participative involvement with stakeholders to obtain feedback, then weighing of cost and other considerations to make the best decision.

CASE STUDY 2

The transit authority is taking advantage of an existing dedicated right-of-way corridor to build a new LRT line to connect an outlying business district to the CBD. Ridership forecasts were developed during early planning stages, and alignment design development has just recently been completed. The route characteristics are shown in Table 17. Members of the authority are familiar with LRT systems in North America and Europe. The authority was impressed with the use of Category-3 LF-LRVs in Europe and might be willing to accept increased technological risk in the interest of obtaining a 100 percent low-floor solution. The authority sees itself as an industry leader and is accustomed to implementing new technology solutions and careful risk management. The authority now wishes to evaluate the costs and benefits of purchasing conventional LRVs and LF-LRVs.

TABLE 17 New LRT system case study—characteristics of new line

One-way line length	24.1 km (15 miles)
Stations	
• Number	30
• Average spacing	0.8 km (0.5 miles)
• Vehicle entrance	Level—Steps
• Wheelchair access	Direct—Ramp/Lift
Track parameters	
• Gauge	1,435 mm (4 ft 8.5 in)
• Minimum horizontal curve radius	18.3 m (60 ft)
• Maximum grade	5%
Estimated system performance	
• Average station dwell (no wheelchairs)	13 sec—18 sec
• Average round-trip speed	25 km/h (15.5 mph)— 23.5 km/h (14.5 mph)
• Round-trip time	1 hr 55 min—2 hr
Design peak service headway	5 min
Design line capacity (crush)	4,500 pax/h/direction
No. of trains required to maintain headway	23—24
Vehicles/train	2
Number of vehicle required, including 15% spares	53—56
Required vehicle crush capacity	188
Expected frequency of wheelchair patrons boarding each vehicle in peak service hours	2 per round trip

OPTIONS AVAILABLE FOR CONSIDERATION

The authority has narrowed down the options to be considered to three:

1. Purchase conventional LRVs; build curb-level station platforms with lifts for ADA compliance.
2. Purchase conventional LRVs; build high-level station platforms to provide level boarding access to vehicles.
3. Purchase LF-LRVs; build low-level station platforms to provide level boarding access.

The applicability assessment model is used to assess these options.

TECHNOLOGICAL RISK ASSESSMENT

The authority expects the new LRT system to begin operation in 3 years. Given this time frame, the authority might

accept a vehicle that has limited in-time service, provided reliability assessments are positive. However, it would not accept a completely new vehicle design. Accordingly, proven equipment criteria were established that require any major subsystem to have been operating in revenue service for at least 2 years (by mid-1995, when the contract will be signed) in a fleet of 10 or more vehicles. The list of acceptable designs is narrowed down to the vehicles/technologies listed in Table 18. The table shows that the authority will consider a wide variety of designs, including four Category-3 solutions, three with novel power trucks.

PHYSICAL COMPATIBILITY EVALUATION

Vehicle-to-Vehicle Compatibility

Coupling. Coupling is not expected to be an issue. If a manufacturer's designed vehicles do not couple, then the design would have to be modified to accommodate coupling.

Buff Load. If it does not already meet North American buff load conventions and authority requirements (1.5 to 2 times the vehicle weight), LRVs would have to be modified to achieve compliance. The authority does not want to take on possible additional risk from accepting a lower buff load capability; thus, it has specified a requirement of 1.5 times the vehicle weight.

Vehicle-to-Right-of-Way Compatibility

The existing alignment and maximum grade of 5 percent pose no problems to any vehicles under consideration.

Vehicle-to-Platform Compatibility

The authority has decided that while it might prefer a low-platform solution, cost is a major issue. Low platforms are seen to be nothing more than raised curbs. High platforms would require carefully applied architectural treatment to ensure the platforms did not become eyesores. Vehicles will require load-leveling capabilities.

Vehicle-to-Maintenance Facility Compatibility

Facility design will not start until a vehicle type is selected. The cost of facility development is expected to be the same regardless of the vehicle selected.

Vehicle-to-Systems Compatibility

Signaling. Selection of vehicle technology will not influence the signaling system.

Power Consumption. The authority estimates that a Category-2 LF-LRV will weigh approximately 7 percent less

than an equivalent conventional vehicle, and a Category-3 LF-LRV will weigh 12 percent less. Corresponding savings of 5.5 percent and 10.5 percent of energy costs are expected. The savings of 5.5 percent is used for the cost estimate.

Fare Collection. The authority has decided to implement a proof-of-payment fare collection system and is carefully looking at ways to improve transfers to and from other modes of transportation. Selection of vehicle type will not affect fare collection decisions.

OPERATIONAL IMPACT QUANTIFICATION

Vehicle Performance

The authority requires that the new vehicles must perform to usual North American standards. A top speed of 80 km/h (50 mph) is desirable, particularly in case the line is extended. Competing European LRVs will require enhanced propulsion systems.

Round-Trip Time

According to the preliminary system characteristics (see Table 16), if the authority purchases conventional LRVs with steps, 24 trains would be utilized during peak hours. These 24 trains maintain their 5-min headway as long as no wheelchairs need to be lifted onto any of the trains. The authority's Operations Department has determined that the peak fleet (for the option using LRVs with steps) would have to be increased by two trains during peak hours to compensate for delays because of wheelchair boarding.

The authority expects that the time savings resulting from the purchase of level-boarding vehicles for the fleet will be two-fold:

1. The boarding of persons in wheelchairs can take place within normal station dwells because level boarding will be provided. Therefore, no additional vehicles will be needed to compensate for this.
2. Boarding time for all other passengers (especially the elderly and passengers carrying packages or pushing strollers) will be reduced at all entrances so that the average station dwell time will be 13 sec, as opposed to 18 sec for LRVs with steps.

A 5-sec reduction in station dwell time would mean a reduction in the round-trip time on the line of 5 min.

Taking into consideration the reduced round-trip time, if the authority incorporates level boarding, 23 trains would be utilized during peak hours (as shown in Table 17). These 23 trains maintain their 5-min headway whether or not wheelchair boardings occur.

Training

Training costs are expected to be the same regardless of the type of vehicle selected.

TABLE 18 New LRT system case study—low-floor vehicles; proven equipment criteria

Category	Manufacturer	Type	Power Truck	Trailing Truck
1	AEG (MAN)	N82	Monomotor	Conventional 2-axle
1	Bombardier (BN)	11/12G	Bimotor	None
1	Bombardier (BN)		Monomotor	Conventional 2-axle
1	Duewag	GT 8C	Monomotor	None
1	Duewag	GT8D	Bimotor	None
1	Duewag	GT 8	Monomotor	None
1	Duewag		Monomotor	Conventional 2-axle
1	GEC Alsthom		Monomotor	Conventional 2-axle
1	LHB	GT 8/8C	Monomotor	None
1	Schindler (SIG)	Be 4/4	Monomotor	Conventional 2-axle
1	Schindler (SIG)	ABe4/8	Bimotor	Conventional two-axle
2	ACM Vevey	Be4/6(8)	Monomotor	Small wheel
2	ACM Vevey	ABe4/6	Bimotor	Small wheel
2	Bombardier (Rotax)	T	Bimotor	Single-axle conventional wheelset steered by articulation
2	Duewag	NGT6C	Monomotor	EEF wheelset
2	Duewag	MGT6D	Bimotor	EEF wheelset
2	Fiat (Firema)	5000	Monomotor	Four independent wheels
2	GEC Alsthom	Be4/6	Monomotor	Small wheel
2	GEC Alsthom	ZR 2000	Monomotor	Independent wheels on two cranked axle
2	Socimi	T8000	Bimotor	Four independent wheels
3	ABB Henschel	Vario-tram	Four hub motor-driven, independent wheels	Four independent wheels
3	AEG (MAN)	GT6(8)N	Independent wheels, one pair driven, one pair free-wheeling	None
3	Breda	VLC	Transverse-mounted motor drives both axles through parallel gears and cardan shaft	Single wheelset with small independent wheels built into articulation
3	Duewag	R3.1	Four hub motor-driven, independent wheels	Four independent wheels

TABLE 19 Preliminary cost estimate for case-2 options

	CONVENTIONAL WITH STEPS	CONVENTIONAL WITH HIGH PLATFORM	LOW WITH LOW PLATFORM
Vehicles			
Per Vehicle Cost	\$2,200,000	\$2,200,000	\$2,200,000
Low-Floor Design Premium	\$0	\$0	\$220,000
Number of Vehicles	55	53	53
Subtotal	\$121,000,000	\$116,600,000	\$128,260,000
New Stations			
Curb-Level Platform	\$75,000	\$0	\$0
Low-Level Platform	\$0	\$0	\$150,000
High-Level Platform	\$0	\$1,200,000	
Wayside Lift	\$50,000	\$0	\$0
Number of New Stations	30	30	30
Subtotal	\$3,750,000	\$36,000,000	\$4,500,000
Additional Recurring Cost			
Operations (1 consist, 2 shifts)	\$80,000	\$0	\$0
Power Consumption	\$0	\$0	(\$68,750)
Maintenance (\$2.00 per mile)	\$31,200	\$0	\$0
Minimum Vehicle Life (yr)	15	15	15
Net Present Value (4%)	\$1,236,365	\$0	(\$764,389)
Schedule Reliability Capital Cost			
Four Additional Vehicles	\$8,800,000	\$8,800,000	\$0
		\$0	\$0
Schedule Reliability Recurring Cost			
Operations (2 consists, 2 shifts)	\$160,000	\$0	\$0
Maintenance (\$2 00 per mile)	\$62,400	\$0	\$0
Minimum Vehicle Life (yr)	15	15	15
Net Present Value (4%)	\$2,472,729	\$0	\$0
TOTAL ESTIMATED COST	\$137,259,094	\$152,600,000	\$131,995,611

COST ESTIMATION

A preliminary cost estimate for the three options is provided in Table 19. Note that costs are provided for illustration only, and that only elements in which prices vary by option are shown.

NONCOST ISSUES

The authority, through focus group meetings, passenger surveys, and feedback from businesses and elected officials, has found that there are a number of issues that cannot be assessed purely in terms of costs.

Aesthetics

The public has resisted some transportation projects in the past. Some transportation improvements have been seen as disruptive and adversely affecting the areas they were intended to serve. Naturally, low platforms are preferred, but

high platforms would be considered acceptable provided they are carefully blended into the existing environment.

Meeting the Needs of Persons in Wheelchairs and Other Passengers

Lobbying groups prefer low-floor, level-boarding solutions. The installation of high platforms still requires passengers to get from sidewalk level to top-of-platform level.

Impact on the City

Some areas along the line are prime candidates for redevelopment. The city has expressed two concerns over the potential installation of high platforms:

- High platforms are utilitarian but detract from the look of the line. Installation of high platforms alongside historic buildings on the route would completely change the feel of the area. Minimalist platforms are seen to be much

more friendly to rejuvenation of the once vibrant commercial areas.

- The installation of high platforms will take up two extra lanes in the existing roadway. Aging utilities in the area will require replacement in the near future. If widened sidewalks are also used to double as low-platform areas, some room will be available along the alignment to establish a utility corridor. Alternatively, utilities would have to be relocated under the sidewalks in close proximity to shallow building foundations. Use of high platforms would preclude the establishment of a utility corridor.

System Growth Capability

The authority is optimistic regarding future expansion of the line. Therefore, long-term implications of present decisions are being carefully evaluated. The dramatic trend to use of 100 percent LF-LRVs in Europe will have at least some impact on future policy decisions here. A decision to install a high-platform system in the face of this knowledge might be unpopular, so adequate justification for a conventional LRV solution would be required.

Acceptance by the Public

The authority has limited budgets and sees a well-used LRT system as the next step in developing an integrated public transportation system that the public will want to use. Traffic congestion and delays in bus service have been the cause for numerous complaints indicating that schedule reliability will be an issue. City council members have stated a preference for LF-LRV solutions since this would do more to prompt revitalization along the line thereby increasing the city's tax base. Given that a LF-LRV seems feasible, focus groups have stated their strong preference for LF-LRVs and the improved accessibility these vehicles provide.

THE NEXT STEPS

The next steps will include refining options and costs, obtaining feedback from stakeholders, and then weighing cost and other considerations to make the best decision.

CHAPTER 7

CONCLUSIONS

INTRODUCTION

There is a growing trend toward the use of low-floor light rail vehicles (LF-LRVs)—as of early 1994, over 1,700 LF-LRVs had been delivered to or ordered by operators in Europe and North America. Since the introduction of LF-LRVs in Europe over 10 years ago, approximately 75 percent of new LRV orders in Europe have been for LF-LRVs.

LF-LRVs provide improved accessibility and are more easily integrated into the existing environment than conventional LRVs. Low floors are typically 350 mm (13.8 in) or less above TOR compared to 910 mm (35.8 in) or more for high floors. Only a single step is needed to board LF-LRVs from curb level compared to three or four steps for conventional high-floor LRVs. Installation of platforms, which might be something as simple as a raised curb, can provide level boarding of the LF-LRV. In contrast, the higher platforms necessary to match high-floor vehicles extend high above the adjacent sidewalk.

Accessibility is becoming a much more important issue in North America. Transit agencies see the increasing need to provide barrier-free service. In the United States, the Americans with Disabilities Act of 1990 requires that rail transportation "... be readily accessible to and usable by individuals with disabilities, including individuals who use wheelchairs ..."

There are problems with making conventional LRVs accessible. High platforms can be provided (or high mini-platforms) to provide level boarding, but these take up considerable space and require a wider right of way. Carborne or wayside lifts can be used to raise wheelchairs from street level to the level of the car floor, but lifts are slow and not failproof. While a person in a wheelchair can board or exit a car during a normal station dwell time where level boarding is provided, it takes 2 to 4 min for this passenger to board or to exit a vehicle when a lift is used. On systems with tight peak-period headways, one person in a wheelchair boarding and exiting a car could potentially cause a delay significant enough that a train could be lost from the peak-period schedule. Also, cars served by lifts or mini-platforms can usually only accommodate two wheelchairs per train. LF-LRVs offer new solutions to these problems.

CLASSIFICATION OF LF-LRVs

There is a wide variety LF-LRVs available, and many of them have a great deal of similarity to each other. An extensive database record of available vehicles is provided in Appendix A. We have developed three categories to simplify discussion and understanding of LF-LRVs:

- *Category 1.* Vehicles use conventional powered and trailing trucks. Vehicles are usually created by adding a body section, articulation, and an additional truck into a conventional LRV. The new body section contains the low-floor section (typically 9% to 15% of the floor area). The vehicles make extensive use of proven technology. Maintenance and operating costs are comparable to those for conventional high-floor vehicles.
- *Category 2.* Conventional motored trucks are used on these vehicles, so vehicle propulsion is not affected. To increase the amount of low-floor area in the vehicle (typically 50% to 70% of the floor area), modified trailer trucks are used. The trailing trucks might use smaller wheels, cranked axles, or independent wheels to accommodate the low-floor area above. The Portland vehicle is an example of a Category-2 vehicle. As in the case of Category-1 vehicles, Category-2 vehicles make extensive use of proven technology. The modified trailer trucks have also proven to be very cost-effective and reliable, so vehicle operating and maintenance costs are comparable to conventional LRVs.
- *Category 3.* Innovative motored and trailing trucks and other novel technologies are used to create vehicles with a 100 percent low-floor area. Unlike conventional LRVs, standard modules are used to create vehicles with multiple articulations, and running gear and drive technologies are substantially different than those used on conventional vehicles. Designs vary widely, and the technology is still rapidly evolving. Category-3 vehicles have not been in service long enough to allow assessment of long-term reliability, maintainability, or cost-effectiveness.

COMPARISON OF CONVENTIONAL AND LF-LRVs

The price of conventional LRVs ranges from \$2 million to \$2.2 million (1994 dollars) per car for orders of 30 or more cars based on recent procurement information from MUNI and DART. The premium cost for LF-LRVs compared to a similar conventional vehicle is between 0 percent and 30 percent. In the case of the Portland Category-2 vehicle, the premium was approximately 10 percent. With the increasing number of low-floor vehicle orders, the premium is expected to disappear completely over the next 5 years.

Virtually all experience with LF-LRVs to date comes from Europe. European practices differ in some ways from those in North America, and the following issues warrant attention in the adaptation of European vehicles:

- *Buff Loads.* European LRVs are designed to withstand buff loads of 20 to 40 tonnes, while North American vehicles are usually required to withstand loads equal to two times the car weight. The significant increase in longitudinal load-carrying capacity requires strengthening of European vehicles and will result in an increase to the vehicle's mass. In the case of mixed consist operation, particularly with conventional and Category-3 vehicles, this problem would be exacerbated.
- *Coupling.* Category-1 and Category-2 vehicles use conventional power trucks; therefore, coupling to conventional vehicles can be accommodated. Category-3 vehicles are often lengthened through the addition of a body section and articulation rather than by coupling to a second vehicle. Because of the different floor heights, coupling Category-3 LF-LRVs with Category-1 or Category-2 LF-LRVs would be problematic.
- *Operating Speed.* Many European LF-LRVs have a top speed of 70 km/h (44 mph), which is substantially slower than some North American transit systems. With operation in city streets and close station spacing, common in Europe, higher top speeds are unimportant. Propulsion systems can be enhanced to provide vehicles that meet North American criteria.
- *Maintenance Facilities.* With the reduced availability of space under the car to support equipment, LF-LRVs make use of space above the roof of the car. As a result, less work is performed in pits, and more work is performed at the car roof level. Raised platforms are needed to support these efforts. Also, many LF-LRVs are longer and have more body sections than conventional LRVs. Requirements for jacks, cranes, and pit and paint booth lengths may vary from those for existing fleets.
- *Fire Resistance.* In order to reduce vehicle weights and improve energy consumption, European vehicles often use lightweight materials. Fire resistance of the carbody, and fire hardening of vehicle roofs are issues that need to be considered.
- *Assess Technological Risk.* While Category-1 and Category-2 LF-LRVs make extensive use of proven technology with a history of reliability and performance, Category-3 LF-LRVs incorporate many technological innovations never previously tried. Agencies should select a vehicle consistent with the degree of risk they are willing to accept.
- *Evaluate Physical Compatibility.* Compatibility of LF-LRVs to the existing infrastructure must be assessed. If a new system is being constructed, the physical infrastructure and the vehicles can be designed to complement each other. If it is an existing system, the ability of cars to run in mixed consists and the potential need for retrofits of platforms, shops, right of way, and systems must be considered. Where the existing line has a number of existing high platforms to provide level boarding of conventional LRVs, use of LF-LRVs is likely inappropriate.
- *Quantify Operational Impacts.* The operation and maintenance of a mixed fleet complicates work practices. At the same time, LF-LRVs offer many advantages. Improved accessibility is an important consideration. If level boarding of LF-LRVs can be provided where level boarding of conventional LRVs cannot, there is the opportunity for a significant improvement in service reliability and reduction in round-trip time. Reduced round-trip times may allow reductions in fleet requirements. For example, with wayside lift loading and unloading of two persons in wheelchairs, a system delay of 10 min or more is possible. Delays of 10 min per trip will manifest either as reduced service reliability or increased vehicles needed to compensate for the delays. With 10-min headways, one additional train would be required. Level boarding of LF-LRVs effectively removes boarding delays and the need for additional vehicles.
- *Evaluate Costs and Benefits.* LF-LRVs currently cost approximately 0 percent to 10 percent more than similar conventional vehicles. It is anticipated that in the near future the cost premium for LF-LRVs will disappear. In addition, loading platforms can be constructed much more cheaply for LF-LRVs, and operating efficiencies may result in fleet requirement savings.
- *Evaluate Noncost Issues.* Transit agencies should weigh a number of noncost considerations. The public increasingly expects barrier-free accessibility to public transportation. The degree of visibility and intrusion of system infrastructure into the existing environment around an LRT line are directly affected by the type of vehicle used. LF-LRVs provide superior solutions with respect to both concerns.

APPLICABILITY OF LF-LRVs IN NORTH AMERICA

There is a great deal of variety in the fleets operated by North American transit agencies and the accompanying right of way, systems, and station infrastructure. Also, depending on whether the agency is procuring vehicles or improving accessibility of an existing line, building a line extension, or constructing a brand new line, the key issues to be addressed will vary. An applicability framework assessment model was developed to assist agencies in the evaluation of LF-LRV applicability. Steps defined in the model are as follows:

- *Define Options.* The availability of LF-LRV solutions provides a new range of options to be considered. These include mixed consist operation (conventional LRVs and LF-LRVs), and the construction of low platforms to allow level boarding at the low-floor level. Other options relating to LF-LRVs are similar to high-floor options.

SUGGESTED RESEARCH

The move to LF-LRVs in Europe is driven by the desire to increase system accessibility. Quantitative data on maintenance costs and cost comparisons of LF-LRVs to conventional LRVs were not recorded by the European transit agencies surveyed, and thus were not available for comparative analyses to be performed.

Additional information on the following would be of use to North American transit agencies:

- Quantitative review of maintenance types and costs for maintenance of LF-LRVs versus conventional LRVs,
 - Qualitative and quantitative review of reliability and maintainability performance of LF-LRVs versus conventional LRVs,
 - Investigation of maintenance procedures developed to meet the unique characteristics of LF-LRVs,
 - Investigation of maintenance facility features and requirements to serve the differing needs of LF-LRVs,
 - Public acceptance of LF-LRVs,
 - Investigation of LF-LRV buff strength and the difficulty in achieving current North American conventions,
 - Performance of LF-LRVs in heavy snow conditions, and
 - Category-3 LF-LRV technology.
-

REFERENCES

1. Hondius, H., "Axles Abandoned to Accommodate Low Floors." *Railway Gazette International* (September 1992) pp 581-586.
 2. Muller, G., "TAG Revitalises Grenoble Area." Rapid Transit Review, *International Railway Journal* (May 1988).
 3. Kuntzer, J. M., and Maltere, P., "Serving the Disabled." Rapid Transit Review, *International Railway Journal* (1989).
 4. "Low Floor LRV Designs Abound." Rapid Transit Review, *International Railway Journal* (1992).
 5. Hondius, H., "All-Low-Floor Cars Dominate Orders." *Developing Metros* (1993).
 6. Hondius, H., "Low Floor Orders Continue to Climb." *Railway Gazette International* October (1992).
 7. "Development Tendency of Low Floor Light Rail Vehicles." Unpublished LRTC report produced as part of this research project.
 8. Daillard, F., "Smaller Wheels as an Alternative for Low Floor Vehicles." *Vevey Technical Bulletin* (1990).
 9. Scherer C., and Stoeri C., "Safety Against Derailment—Development of Calculating Methods Characteristics of Wheels." *Vevey Technical Bulletin* (1990).
 10. "Summary Description Low-Floor-Metro Car, Type 'T,' for Vienna Metro Line U6." Bombardier report (based on Translation of P. Lehotzky, "Niederflur-U-Bahnwagen für Wien." *Der Nahverkehr*, [March 1991]).
 11. Frederich, F., "Einzelrad-Einzelfahrwerke," Institut für Fördertechnik und Schienenfahrzeuge, Rhein.-Westf. Technische Hochschule Aachen.
 12. Lehotzy, P., "Lower Floor Tram for Vienna." Translation of an article that appeared in *Der Nahverkehr* (May 1993).
 13. Hondius, H., "Low Floor Development out of Control." *Railway Gazette International* (November 1991) pp 797-798.
 14. Hondius, H., "German Cities Dominate Deliveries of Novel Low and Middle-Floor Cars." *Developing Metros 1994, Railway Gazette International Year Book*.
-

APPENDIX A

LOW-FLOOR LIGHT RAIL VEHICLE (LF-LRV) DATABASE

The axle arrangement code definitions are included in Appendix C.

CATEGORY-1 LF-LRVs

City/Authority: Amsterdam/ GVBA
(Netherlands)

Manufacturers: Bombardier (BN)
Holec

Vehicle Type: 11G & 12G

Category: 1

Ordered: 45

Year of Delivery: 1989

CHARACTERISTICS

Car Length: 25.63 m (84.1 ft)

Car Width: 2.35 m (7.7 ft)

Low Floor Area: 9%

Floor Height

High: 870 mm (34.3 in)

Low: 280 mm (11 in)

Weight: 36.9 tonnes (81,400 lbs)

Specific Weight: 613 kg/m² (126 lb/ft²)

Seats: 63

Standees: 90 @ 4 pass/m²

CONSTRUCTION

Travel Direction: Bidirectional

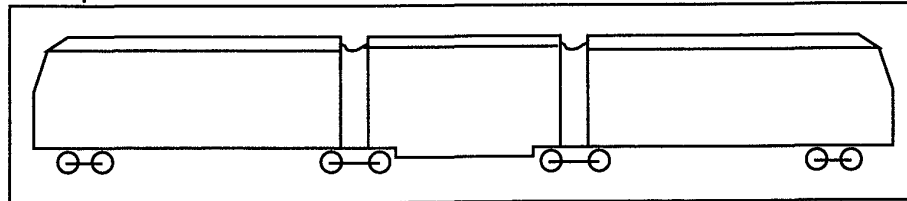
Doors: Three Double, One Single

Articulation: Supported

Body Material: N/A

Buff Load: 20 tonnes (44,100 lbs)

Concept Schematic



RUNNING GEAR

Axle Arrangement: Bo'Bo'Bo'Bo'

Power Wheel Diameter: 662 mm (26.1 in)

Power Gear: Conventional bi-motor

Trailer Wheel Diameter: 662 mm (26.1 in)

Trailer Gear: N/A

Track Gauge: 1435 mm (56.5 in)

Min Curve Radius: 25 m (82 ft)

Max Speed: 70 km/h (44 mph)

PROPULSION

Propulsion Technology: AC

Line Voltage: 600 V

Number of Motors: 8

Total Power: 308 kW (413 hp)

Specific Power: 8.3 kW/tonne (10.2 hp/ton)

BRAKES

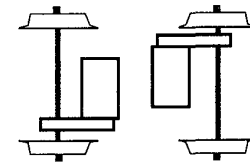
1. Regenerative
2. Eight Drum Hydraulic Friction
3. Eight Track Brakes

PRICE DATA

Cost Density: N/A

Vehicle Cost: N/A

Powered Running Gear



Trailing Running Gear

City/Authority: Antwerp/ De Lijn
(Belgium)

Manufacturers: Bombardier (BN)

Vehicle Type: N/A

Category: 1

Ordered: 10

Year of Delivery: 1993

CHARACTERISTICS

Car Length: 29.28 m (96.1 ft)

Car Width: 2.3 m (7.5 ft)

Low Floor Area: 10.1%

Floor Height

High: 860 mm (33.9 in)

Low: 350 mm (13.8 in)

Weight: 42 tonnes (92,600 lbs)

Specific Weight: 624 kg/m² (128 lb/ft²)

Seats: 69

Standees: 124 @ 4 pass/m²

CONSTRUCTION

Travel Direction: N/A

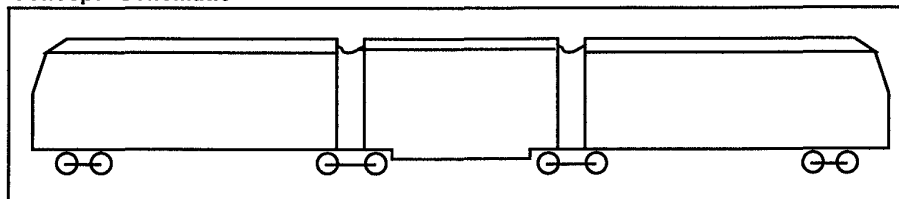
Doors: N/A

Articulation: Supported

Body Material: N/A

Buff Load: N/A

Concept Schematic



RUNNING GEAR

Axle Arrangement: B'2'2'B'

Power Wheel Diameter: 680 mm (26.8 in)

Power Gear: Conventional monomotor

Trailer Wheel Diameter: 680 mm (26.8 in)

Trailer Gear: Conventional two-axle

Track Gauge: 1000 mm (39.4 in)

Min Curve Radius: N/A

Max Speed: 80 km/h (50 mph)

PROPULSION

Propulsion Technology: N/A

Line Voltage: 600 V

Number of Motors: 2

Total Power: 432 kW (579 hp)

Specific Power: 10.3 kW/tonne (12.5 hp/ton)

BRAKES

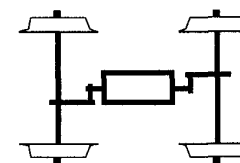
N/A

PRICE DATA

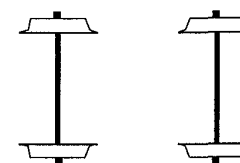
Cost Density: N/A

Vehicle Cost: N/A

Powered Running Gear



Trailing Running Gear



City/Authority: Basle/ BVB
(Switzerland)

Manufacturers: Schindler (SIG)
Siemens

Vehicle Type: Be 4/4

Category: 1

Ordered: 19

Year of Delivery: 1987

CHARACTERISTICS

Car Length: 25.4 m (83.3 ft)

Car Width: 2.2 m (7.2 ft)

Low Floor Area: 15%

Floor Height

High: 855 mm (33.7 in)

Low: 325 mm (12.8 in)

Weight: 31 tonnes (68,300 lbs)

Specific Weight: 555 kg/m² (114 lb/ft²)

Seats: 60

Standeers: 97 @ 4 pass/m²

CONSTRUCTION

Travel Direction: Unidirectional

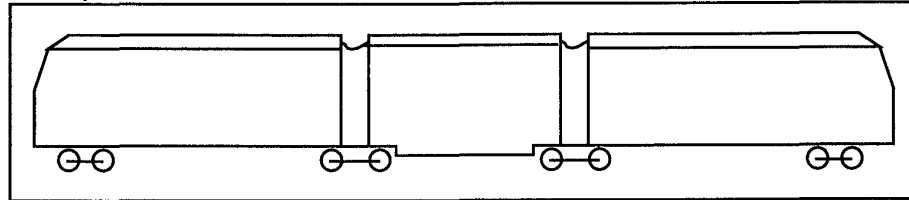
Doors: N/A

Articulation: N/A

Body Material: N/A

Buff Load: N/A

Concept Schematic



RUNNING GEAR

Axle Arrangement: B'2'2'B'

Power Wheel Diameter: 670 mm (26.4 in)

Power Gear: Conventional monomotor

Trailer Wheel Diameter: 670 mm (26.4 in)

Trailer Gear: Conventional two-axle

Track Gauge: 1000 mm (39.4 in)

Min Curve Radius: 12 m (39.4 ft)

Max Speed: 65 km/h (40 mph)

PROPULSION

Propulsion Technology: DC

Line Voltage: 600 V

Number of Motors: 2

Total Power: 300 kW (402 hp)

Specific Power: 9.7 kW/tonne (11.8 hp/ton)

BRAKES

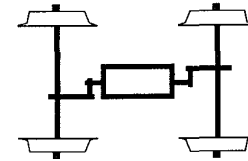
N/A

PRICE DATA

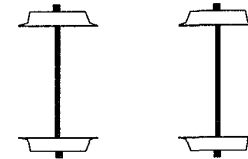
Cost Density: N/A

Vehicle Cost: N/A

Powered Running Gear



Trailing Running Gear



City/Authority: Freiburg
(Germany)

Manufacturers: Duewag
ABB

Vehicle Type: GT8D-MNZ

Category: 1

Ordered: 26

Year of Delivery: 1993

CHARACTERISTICS

Car Length: 33.09 m (108.6 ft)

Car Width: 2.3 m (7.5 ft)

Low Floor Area: 48%

Floor Height

High: 560 mm (22 in)

Low: 290 mm (11.4 in)

Weight: 38.5 tonnes (84,900 lbs)

Specific Weight: 506 kg/m² (104 lb/ft²)

Seats: 84

Standees: 121 @ 4 pass/m²

CONSTRUCTION

Travel Direction: Bidirectional

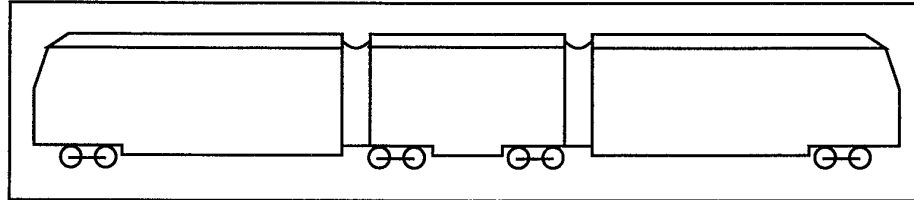
Doors: Four Double

Articulation: Floating

Body Material: Aluminum

Buff Load: N/A

Concept Schematic



RUNNING GEAR

Axle Arrangement: Bo'Bo'Bo'Bo'

Power Wheel Diameter: 590 mm (23.2 in)

Power Gear: Conventional bi-motor

Trailer Wheel Diameter: N/A

Trailer Gear: N/A

Track Gauge: 1000 mm (39.4 in)

Min Curve Radius: 19 m (62.3 ft)

Max Speed: 70 km/h (44 mph)

PROPULSION

Propulsion Technology: AC

Line Voltage: 750 V

Number of Motors: 8

Total Power: 640 kW (858 hp)

Specific Power: 16.6 kW/tonne (20.2 hp/ton)

BRAKES

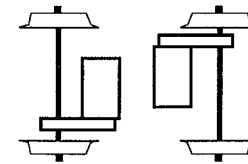
N/A

PRICE DATA

Cost Density: N/A

Vehicle Cost: N/A

Powered Running Gear



Trailing Running Gear

City/Authority: Freiburg/ VAG
(Germany)

Manufacturers: Duewag
ABB

Vehicle Type: GT 8C

Category: 1

Ordered: 11

Year of Delivery: 1990

CHARACTERISTICS

Car Length: 32.84 m (107.7 ft)

Car Width: 2.3 m (7.5 ft)

Low Floor Area: 9%

Floor Height

High: 910 mm (35.8 in)

Low: 270 mm (10.6 in)

Weight: 38.5 tonnes (84,900 lbs)

Specific Weight: 510 kg/m² (105 lb/ft²)

Seats: 84

Standees: 115 @ 4 pass/m²

CONSTRUCTION

Travel Direction: Unidirectional

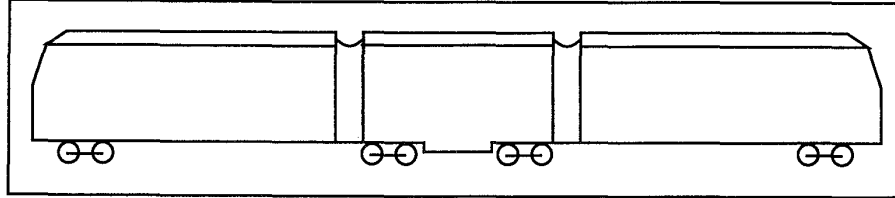
Doors: Five Double

Articulation: Floating

Body Material: N/A

Buff Load: N/A

Concept Schematic



RUNNING GEAR

Axle Arrangement: B'B'B'B'

Power Wheel Diameter: 690 mm (27.2 in)

Power Gear: Conventional monomotor

Trailer Wheel Diameter: 690 mm (27.2 in)

Trailer Gear: N/A

Track Gauge: 1000 mm (39.4 in)

Min Curve Radius: 25 m (82 ft)

Max Speed: 70 km/h (44 mph)

PROPULSION

Propulsion Technology: DC

Line Voltage: 750 V

Number of Motors: 4

Total Power: 600 kW (805 hp)

Specific Power: 15.6 kW/tonne (19 hp/ton)

BRAKES

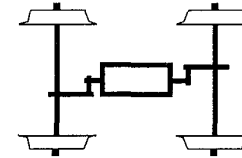
N/A

PRICE DATA

Cost Density: N/A

Vehicle Cost: N/A

Powered Running Gear



Trailing Running Gear

City/Authority: Mannheim
(Germany)

Manufacturers: Duewag

Vehicle Type: N/A

Category: 1

Ordered: 23

Year of Delivery: 1991

CHARACTERISTICS

Car Length: 25.66 m (84.2 ft)

Car Width: 2.2 m (7.2 ft)

Low Floor Area: 8.9%

Floor Height

High: 889 mm (35 in)

Low: 353 mm (13.9 in)

Weight: 26 tonnes (57,300 lbs)

Specific Weight: 461 kg/m² (95 lb/ft²)

Seats: 54

Standees: 100 @ 4 pass/m²

CONSTRUCTION

Travel Direction: Unidirectional

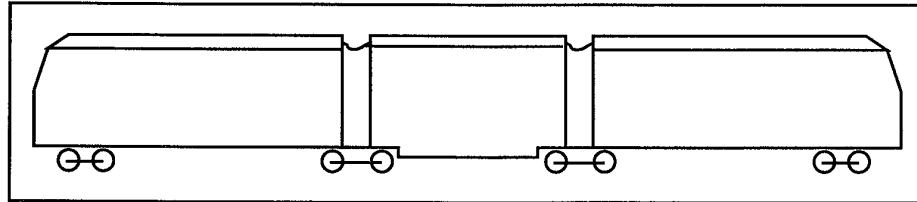
Doors: N/A

Articulation: N/A

Body Material: N/A

Buff Load: N/A

Concept Schematic



RUNNING GEAR

Axle Arrangement: B'2'2'B'

Power Wheel Diameter: 680 mm (26.8 in)

Power Gear: Conventional monomotor

Trailer Wheel Diameter: 680 mm (26.8 in)

Trailer Gear: Conventional two-axle

Track Gauge: 1000 mm (39.4 in)

Min Curve Radius: 25 m (82 ft)

Max Speed: 60 km/h (37 mph)

PROPULSION

Propulsion Technology: DC

Line Voltage: 600 V

Number of Motors: 2

Total Power: 240 kW (322 hp)

Specific Power: 9.2 kW/tonne (11.2 hp/ton)

BRAKES

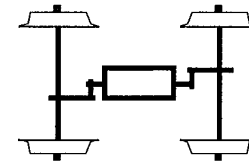
N/A

PRICE DATA

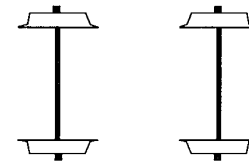
Cost Density: \$52,750 \$/DM/m²

Vehicle Cost: N/A

Powered Running Gear



Trailing Running Gear



City/Authority: Nantes/ SEMITAN
(France)

Manufacturers: GEC Alsthom

Vehicle Type: N/A

Category: 1

Ordered: 34

Year of Delivery: 1992

CHARACTERISTICS

Car Length: 39.15 m (128.4 ft)

Car Width: 2.3 m (7.5 ft)

Low Floor Area: 16.3%

Floor Height

High: 873 mm (34.4 in)

Low: 353 mm (13.9 in)

Weight: 51.9 tonnes (114,400 lbs)

Specific Weight: 576 kg/m² (119 lb/ft²)

Seats: 74

Standees: 178 @ 4 pass/m²

CONSTRUCTION

Travel Direction: Bidirectional

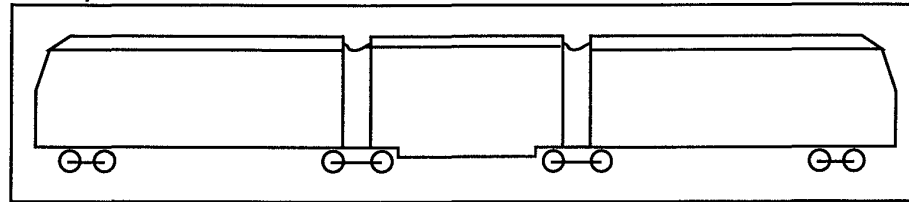
Doors: N/A

Articulation: N/A

Body Material: N/A

Buff Load: N/A

Concept Schematic



RUNNING GEAR

Axle Arrangement: B'2'2'B'

Power Wheel Diameter: 660 mm (26 in)

Power Gear: Conventional monomotor

Trailer Wheel Diameter: 660 mm (26 in)

Trailer Gear: Conventional two-axle

Track Gauge: 1435 mm (56.5 in)

Min Curve Radius: 25 m (82 ft)

Max Speed: 70 km/h (44 mph)

PROPULSION

Propulsion Technology: DC

Line Voltage: 750 V

Number of Motors: 2

Total Power: 550 kW (738 hp)

Specific Power: 10.6 kW/tonne (12.9 hp/ton)

BRAKES

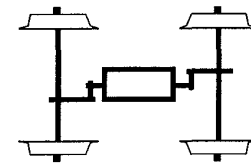
N/A

PRICE DATA

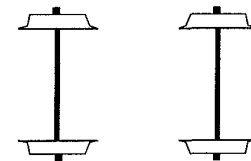
Cost Density: N/A

Vehicle Cost: N/A

Powered Running Gear



Trailing Running Gear



City/Authority: Nantes/ SEMITAN
(France)

Manufacturers: GEC Alsthom
De Dietrich

Vehicle Type: N/A

Category: 1

Ordered: 12

Year of Delivery: 1993

CHARACTERISTICS

Car Length: 39.15 m (128.4 ft)

Car Width: 2.3 m (7.5 ft)

Low Floor Area: 17.5%

Floor Height

High: 850 mm (33.5 in)

Low: 350 mm (13.8 in)

Weight: 51.6 tonnes (113,800 lbs)

Specific Weight: 573 kg/m² (118 lb/ft²)

Seats: 74

Standees: 178 @ 4 pass/m²

CONSTRUCTION

Travel Direction: Bidirectional

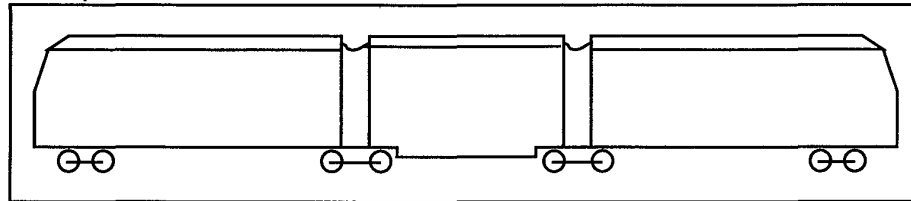
Doors: N/A

Articulation: N/A

Body Material: N/A

Buff Load: N/A

Concept Schematic



RUNNING GEAR

Axle Arrangement: B'2'2'B'

Power Wheel Diameter: 660 mm (26 in)

Power Gear: Conventional monomotor

Trailer Wheel Diameter: 660 mm (26 in)

Trailer Gear: Conventional two-axle

Track Gauge: 1435 mm (56.5 in)

Min Curve Radius: N/A

Max Speed: 70 km/h (44 mph)

PROPULSION

Propulsion Technology: DC

Line Voltage: 750 V

Number of Motors: 2

Total Power: 550 kW (738 hp)

Specific Power: 10.7 kW/tonne (13 hp/ton)

BRAKES

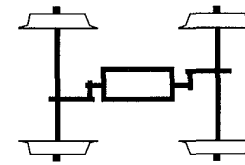
N/A

PRICE DATA

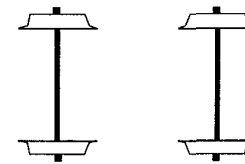
Cost Density: \$50,870 \$DM/m²

Vehicle Cost: N/A

Powered Running Gear



Trailing Running Gear



City/Authority: Nurnberg
(Germany)

Manufacturers: AEG (MAN)
Duewag
Siemens

Vehicle Type: N82

Category: 1

Ordered: 12

Year of Delivery: 1992

CHARACTERISTICS

Car Length: 26.08 m (85.6 ft)

Car Width: 2.3 m (7.5 ft)

Low Floor Area: 9.3%

Floor Height

High: 880 mm (34.6 in)

Low: 284 mm (11.2 in)

Weight: 32.8 tonnes (72,300 lbs)

Specific Weight: 547 kg/m² (113 lb/ft²)

Seats: 51

Standees: 85 @ 4 pass/m²

CONSTRUCTION

Travel Direction: Unidirectional

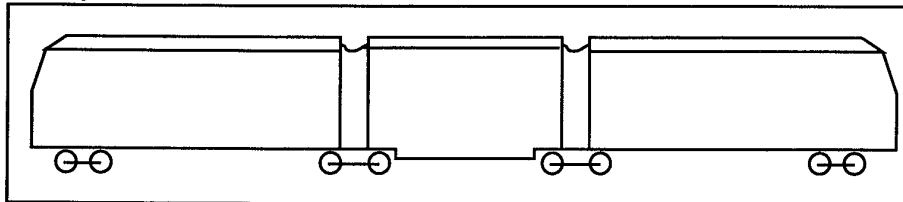
Doors: Four Double

Articulation: Floating

Body Material: Steel

Buff Load: N/A

Concept Schematic



RUNNING GEAR

Axle Arrangement: B'2'2'B'

Power Wheel Diameter: 680 mm (26.8 in)

Power Gear: Conventional monomotor

Trailer Wheel Diameter: 680 mm (26.8 in)

Trailer Gear: Conventional two-axle

Track Gauge: 1435 mm (56.5 in)

Min Curve Radius: 25 m (82 ft)

Max Speed: 70 km/h (44 mph)

PROPULSION

Propulsion Technology: DC

Line Voltage: 600 V

Number of Motors: 2

Total Power: 240 kW (322 hp)

Specific Power: 7.3 kW/tonne (8.9 hp/ton)

BRAKES

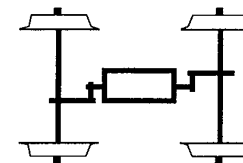
Regenerative

PRICE DATA

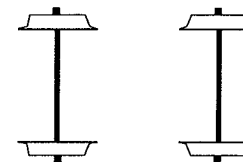
Cost Density: N/A

Vehicle Cost: N/A

Powered Running Gear



Trailing Running Gear



City/Authority: **RBS**
(Switzerland)

Manufacturers: **Schindler (SIG)**
SIG
ABB

Vehicle Type: **ABe4/8**

Category: **1**

Ordered: **23**

Year of Delivery: **1992**

CHARACTERISTICS

Car Length: 39.3 m (128.9 ft)

Car Width: 2.65 m (8.7 ft)

Low Floor Area: 50%

Floor Height

High: 830 mm (32.7 in)

Low: 390 mm (15.4 in)

Weight: 51 tonnes (112,400 lbs)

Specific Weight: 490 kg/m² (100 lb/ft²)

Seats: 120

Standees: 140 @ 4 pass/m²

CONSTRUCTION

Travel Direction: N/A

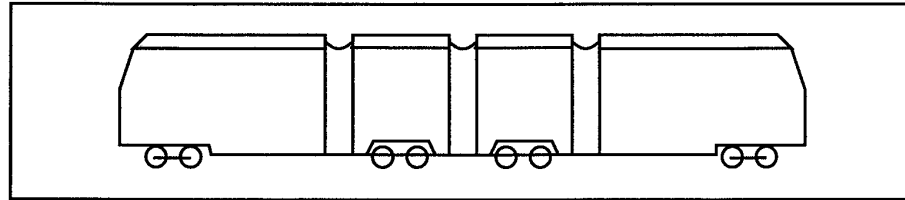
Doors: Four Double

Articulation: Non-Articulat

Body Material: N/A

Buff Load: N/A

Concept Schematic



RUNNING GEAR

Axle Arrangement: Bo'2'2'Bo'

Power Wheel Diameter: 720 mm (28.3 in)

Power Gear: Conventional bi-motor

Trailer Wheel Diameter: 720 mm (28.3 in)

Trailer Gear: Conventional two-axle

Track Gauge: 1000 mm (39.4 in)

Min Curve Radius: N/A

Max Speed: 90 km/h (56 mph)

PROPULSION

Propulsion Technology: AC

Line Voltage: 1200 V

Number of Motors: 4

Total Power: 600 kW (805 hp)

Specific Power: 11.8 kW/tonne (14.3 hp/ton)

BRAKES

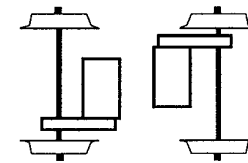
N/A

PRICE DATA

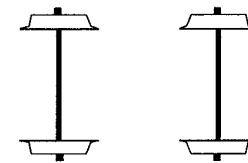
Cost Density: N/A

Vehicle Cost: N/A

Powered Running Gear



Trailing Running Gear



City/Authority: Sheffield/ SYST
(United Kingdom)

Manufacturers: Duewag
Siemens

Vehicle Type: GT 8

Category: 1

Ordered: 25

Year of Delivery: 1993

CHARACTERISTICS

Car Length: 34.75 m (114 ft)

Car Width: 2.65 m (8.7 ft)

Low Floor Area: 34%

Floor Height

High: 880 mm (34.6 in)

Low: 480 mm (18.9 in)

Weight: 46 tonnes (101,400 lbs)

Specific Weight: 500 kg/m² (102 lb/ft²)

Seats: 88

Standees: 150 @ 4 pass/m²

CONSTRUCTION

Travel Direction: Bidirectional

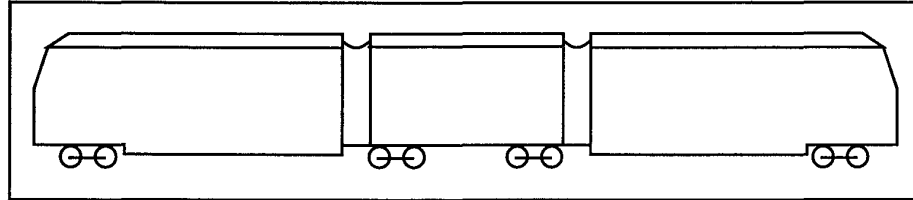
Doors: Four Double, One Single

Articulation: Floating

Body Material: Welded Corten-B Steel

Buff Load: N/A

Concept Schematic



RUNNING GEAR

Axle Arrangement: B'B'B'B'

Power Wheel Diameter: 670 mm (26.4 in)

Power Gear: Conventional monomotor

Trailer Wheel Diameter: N/A

Trailer Gear: N/A

Track Gauge: 1435 mm (56.5 in)

Min Curve Radius: 25 m (82 ft)

Max Speed: 80 km/h (50 mph)

PROPULSION

Propulsion Technology: DC

Line Voltage: 750 V

Number of Motors: 4

Total Power: 1000 kW (1341 hp)

Specific Power: 21.7 kW/tonne (26.4 hp/ton)

BRAKES

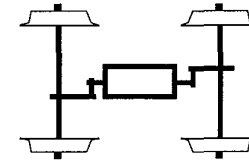
1. Combined Regenerative and Rheostatic
2. Spring-Applied Pneumatic
3. Track

PRICE DATA

Cost Density: \$53000 \$DM/m²

Vehicle Cost: N/A

Powered Running Gear



Trailing Running Gear

City/Authority: Wurzburg
(Germany)

Manufacturers: LHB
Siemens

Vehicle Type: GT 8/8C

Category: 1

Ordered: 14

Year of Delivery: 1989

CHARACTERISTICS

Car Length: 32.6 m (107 ft)

Car Width: 2.4 m (7.9 ft)

Low Floor Area: 9.8%

Floor Height

High: 910 mm (35.8 in)

Low: 310 mm (12.2 in)

Weight: 42.5 tonnes (93,700 lbs)

Specific Weight: 543 kg/m² (111 lb/ft²)

Seats: 78

Standees: 125 @ 4 pass/m²

CONSTRUCTION

Travel Direction: Unidirectional

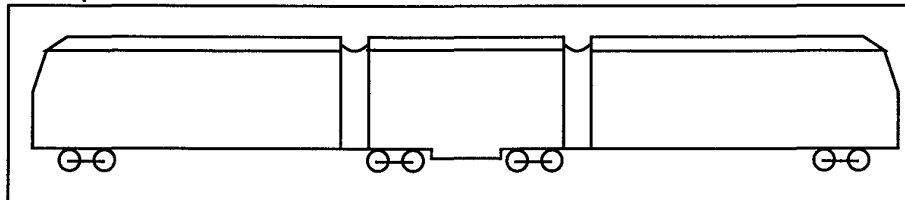
Doors: Five Double

Articulation: Floating

Body Material: N/A

Buff Load: 20 tonnes (44,100 lbs)

Concept Schematic



RUNNING GEAR

Axle Arrangement: B'B'B'B'

Power Wheel Diameter: 690 mm (27.2 in)

Power Gear: Conventional monomotor

Trailer Wheel Diameter: 690 mm (27.2 in)

Trailer Gear: N/A

Track Gauge: 1000 mm (39.4 in)

Min Curve Radius: 25 m (82 ft)

Max Speed: 70 km/h (44 mph)

PROPULSION

Propulsion Technology: DC

Line Voltage: 750 V

Number of Motors: 4

Total Power: 648 kW (869 hp)

Specific Power: 15.2 kW/tonne (18.5 hp/ton)

BRAKES

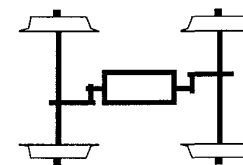
N/A

PRICE DATA

Cost Density: N/A

Vehicle Cost: N/A

Powered Running Gear



Trailing Running Gear

CATEGORY-2 LF-LRVs

City/Authority: Bern/ SVB
(Switzerland)

Manufacturers: ACM Vevey
Duewag
ABB

Vehicle Type: Be4/8

Category: 2

Ordered: 12

Year of Delivery: 1989

CHARACTERISTICS

Car Length: 31 m (101.7 ft)

Car Width: 2.2 m (7.2 ft)

Low Floor Area: 72.8%

Floor Height

High: 710 mm (28 in)

Low: 350 mm (13.8 in)

Weight: 34 tonnes (75,000 lbs)

Specific Weight: 499 kg/m² (102 lb/ft²)

Seats: 68

Standees: 109 @ 4 pass/m²

CONSTRUCTION

Travel Direction: Unidirectional

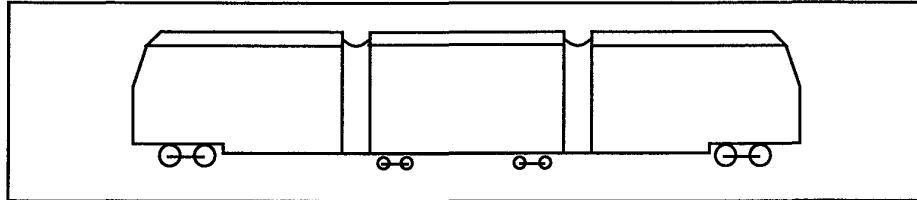
Doors: Six Double

Articulation: Floating

Body Material: Welded Grade 52 Steel

Buff Load: N/A

Concept Schematic



RUNNING GEAR

Axle Arrangement: B'2'2'B'

Power Wheel Diameter: 560 mm (22 in)

Power Gear: Conventional monomotor

Trailer Wheel Diameter: 410 mm (16.1 in)

Trailer Gear: Small wheel trailer truck

Track Gauge: 1000 mm (39.4 in)

Min Curve Radius: 15 m (49.2 ft)

Max Speed: 60 km/h (37 mph)

PROPULSION

Propulsion Technology: DC

Line Voltage: 600 V

Number of Motors: 2

Total Power: 302 kW (405 hp)

Specific Power: 8.9 kW/tonne (10.8 hp/ton)

BRAKES

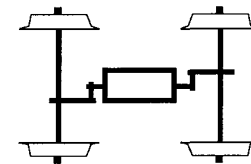
1. Hydraulic Disk
2. Rail Braking System

PRICE DATA

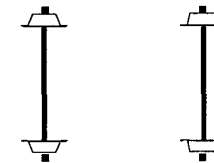
Cost Density: N/A

Vehicle Cost: \$SFr 3,000,000

Powered Running Gear



Trailing Running Gear



City/Authority: Bogestra/ Bochum
(Germany)

Manufacturers: Duewag
Siemens

Vehicle Type: MGT6D

Category: 2

Ordered: 43

Year of Delivery: 1992

CHARACTERISTICS

Car Length: 28.62 m (93.9 ft)

Car Width: 2.3 m (7.5 ft)

Low Floor Area: 65%

Floor Height

High: 560 mm (22 in)

Low: 350 mm (13.8 in)

Weight: 32 tonnes (70,500 lbs)

Specific Weight: 486 kg/m² (100 lb/ft²)

Seats: 72

Standees: 100 @ 4 pass/m²

CONSTRUCTION

Travel Direction: Bidirectional

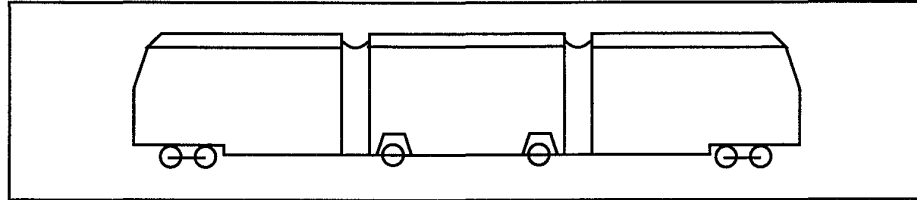
Doors: Three Double

Articulation: Floating

Body Material: Steel

Buff Load: N/A

Concept Schematic



RUNNING GEAR

Axle Arrangement: Bo'1'1'Bo'

Power Wheel Diameter: 575 mm (22.6 in)

Power Gear: Conventional bi-motor

Trailer Wheel Diameter: 575 mm (22.6 in)

Trailer Gear: EEF wheelset

Track Gauge: 1000 mm (39.4 in)

Min Curve Radius: 15 m (49.2 ft)

Max Speed: 70 km/h (44 mph)

PROPULSION

Propulsion Technology: AC

Line Voltage: 600 V

Number of Motors: 4

Total Power: 420 kW (563 hp)

Specific Power: 13.1 kW/tonne (16 hp/ton)

BRAKES

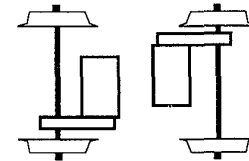
N/A

PRICE DATA

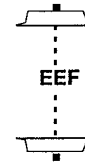
Cost Density: N/A

Vehicle Cost: N/A

Powered Running Gear



Trailing Running Gear



City/Authority: Bonn
(Germany)

Manufacturers: Duewag
Siemens

Vehicle Type: NGT6D

Category: 2

Ordered: 24

Year of Delivery: 1994

CHARACTERISTICS

Car Length: 28.62 m (93.9 ft)

Car Width: 2.3 m (7.5 ft)

Low Floor Area: 65%

Floor Height

High: 560 mm (22 in)

Low: 350 mm (13.8 in)

Weight: 31.5 tonnes (69,400.lbs)

Specific Weight: 479 kg/m² (99 lb/ft²)

Seats: 72

Standeers: 100 @ 4 pass/m²

CONSTRUCTION

Travel Direction: Bidirectional

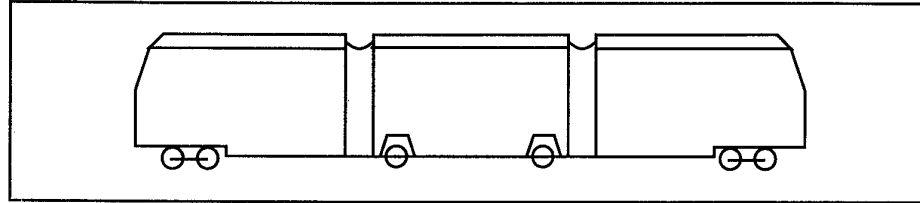
Doors: N/A

Articulation: N/A

Body Material: N/A

Buff Load: N/A

Concept Schematic



RUNNING GEAR

Axle Arrangement: Bo'1'1'Bo'

Power Wheel Diameter: 600 mm (23.6 in)

Power Gear: Conventiqnal bi-motor

Trailer Wheel Diameter: 600 mm (23.6 in)

Trailer Gear: EEF wheelset

Track Gauge: 1435 mm (56.5 in)

Min Curve Radius: 15 m (49.2 ft)

Max Speed: 70 km/h (44 mph)

PROPULSION

Propulsion Technology: AC

Line Voltage: 600 V

Number of Motors: 4

Total Power: 360 kW (483 hp)

Specific Power: 11.4 kW/tonne (13.9 hp/ton)

BRAKES

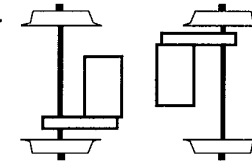
N/A

PRICE DATA

Cost Density: \$57,000 \$DM/m²

Vehicle Cost: N/A

Powered Running Gear



Trailing Running Gear



City/Authority: Brandenburg
(Germany)

Manufacturers: Duewag
Siemens

Vehicle Type: MGT6D

Category: 2

Ordered: 4

Year of Delivery: N/A

CHARACTERISTICS

Car Length: 28.62 m (93.9 ft)

Car Width: 2.3 m (7.5 ft)

Low Floor Area: 65%

Floor Height

High: 560 mm (22 in)

Low: 350 mm (13.8 in)

Weight: 32 tonnes (70,500 lbs)

Specific Weight: 486 kg/m² (100 lb/ft²)

Seats: 72

Standees: 100 @ 4 pass/m²

CONSTRUCTION

Travel Direction: Bidirectional

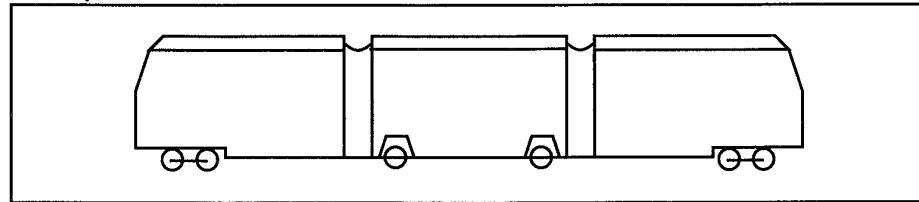
Doors: Three Double

Articulation: Floating

Body Material: Steel

Buff Load: N/A

Concept Schematic



RUNNING GEAR

Axle Arrangement: Bo'1'1'Bo'

Power Wheel Diameter: 575 mm (22.6 in)

Power Gear: Conventional bi-motor

Trailer Wheel Diameter: 575 mm (22.6 in)

Trailer Gear: EEF wheelset

Track Gauge: 1000 mm (39.4 in)

Min Curve Radius: 15 m (49.2 ft)

Max Speed: 70 km/h (44 mph)

PROPULSION

Propulsion Technology: AC

Line Voltage: 600 V

Number of Motors: 4

Total Power: 420 kW (563 hp)

Specific Power: 13.1 kW/tonne (16 hp/ton)

BRAKES

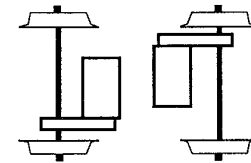
N/A

PRICE DATA

Cost Density: N/A

Vehicle Cost: N/A

Powered Running Gear



Trailing Running Gear



City/Authority: Brno City Transport
(Czech Rep.)

Manufacturers: CKD Tatra

Vehicle Type: RT6-N1

Category: 2

Ordered: 12

Year of Delivery: N/A

CHARACTERISTICS

Car Length: 26.28 m (86.2 ft)

Car Width: 2.44 m (8 ft)

Low Floor Area: 63%

Floor Height

High: 900 mm (35.4 in)

Low: 350 mm (13.8 in)

Weight: 32 tonnes (70,500 lbs)

Specific Weight: 499 kg/m² (102 lb/ft²)

Seats: 45

Standees: 93 @ 4 pass/m²

CONSTRUCTION

Travel Direction: Bidirectional

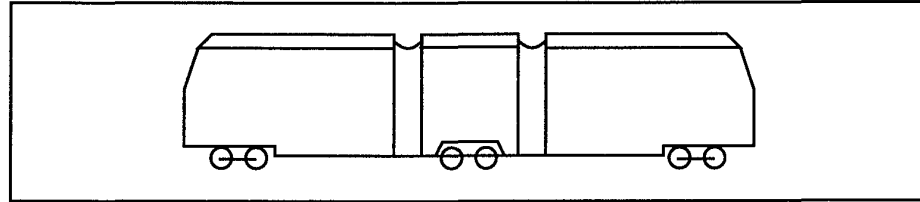
Doors: Four Double, Two Single

Articulation: Floating

Body Material: Welded Steel

Buff Load: N/A

Concept Schematic



RUNNING GEAR

Axle Arrangement: Bo'2Bo'

Power Wheel Diameter: 700 mm (27.6 in)

Power Gear: Conventional bi-motor

Trailer Wheel Diameter: 700 mm (27.6 in)

Trailer Gear: Four independent wheel trailer truck

Track Gauge: 1435 mm (56.5 in)

Min Curve Radius: 25 m (82 ft)

Max Speed: 80 km/h (50 mph)

PROPULSION

Propulsion Technology: DC

Line Voltage: 600 V

Number of Motors: 4

Total Power: 380 kW (510 hp)

Specific Power: 11.9 kW/tonne (14.5 hp/ton)

BRAKES

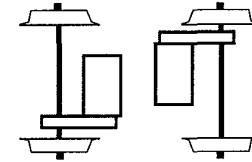
- 1. Regenerative
- 2. Hydraulic Disk
- 3. Rail Brakes

PRICE DATA

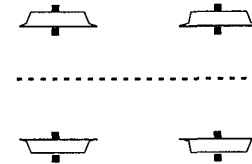
Cost Density: N/A

Vehicle Cost: N/A

Powered Running Gear



Trailing Running Gear



City/Authority: Buenos Aires
(Argentina)

Manufacturers: Duewag
Siemens
GEC Alsthom
CAF

Vehicle Type: N/A

Category: 2

Ordered: 9

Year of Delivery: 1994

CHARACTERISTICS

Car Length: 23.78 m (78 ft)

Car Width: 2.4 m (7.9 ft)

Low Floor Area: 62%

Floor Height

High: 560 mm (22 in)

Low: 350 mm (13.8 in)

Weight: 29.7 tonnes (65,500 lbs)

Specific Weight: 520 kg/m² (106 lb/ft²)

Seats: 65

Standees: 91 @ 4 pass/m²

CONSTRUCTION

Travel Direction: Unidirectional

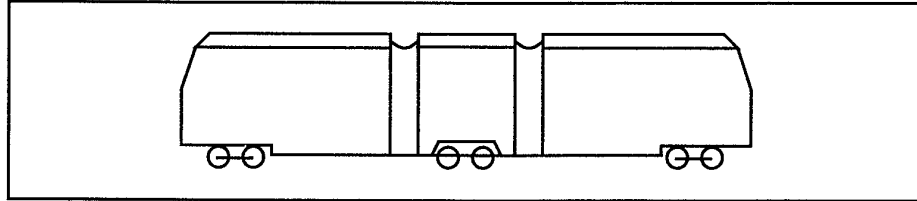
Doors: Four Double

Articulation: Floating

Body Material: N/A

Buff Load: N/A

Concept Schematic



RUNNING GEAR

Axle Arrangement: Bo'2Bo'

Power Wheel Diameter: 590 mm (23.2 in)

Power Gear: Conventional bi-motor

Trailer Wheel Diameter: 590 mm (23.2 in)

Trailer Gear: Four independent wheel trailer truck

Track Gauge: 1000 mm (39.4 in)

Min Curve Radius: 25 m (82 ft)

Max Speed: 70 km/h (44 mph)

PROPULSION

Propulsion Technology: AC

Line Voltage: 750 V

Number of Motors: 4

Total Power: 360 kW (483 hp)

Specific Power: 12.1 kW/tonne (14.8 hp/ton)

BRAKES

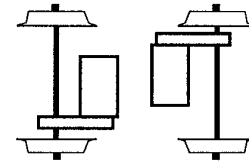
Rheostatic

PRICE DATA

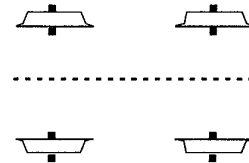
Cost Density: N/A

Vehicle Cost: N/A

Powered Running Gear



Trailing Running Gear



City/Authority: Cologne
(Germany)

Manufacturers: Bombardier (Rotax)
Kiepe
GEC Alsthom

Vehicle Type: T

Category: 2

Ordered: 40

Year of Delivery: N/A

CHARACTERISTICS

Car Length: 26.8 m (87.9 ft)

Car Width: 2.65 m (8.7 ft)

Low Floor Area: 60%

Floor Height

High: 530 mm (20.9 in)

Low: 440 mm (17.3 in)

Weight: 34.7 tonnes (76,500 lbs)

Specific Weight: 489 kg/m² (100 lb/ft²)

Seats: 58

Standees: 136 @ 4 pass/m²

CONSTRUCTION

Travel Direction: Bidirectional

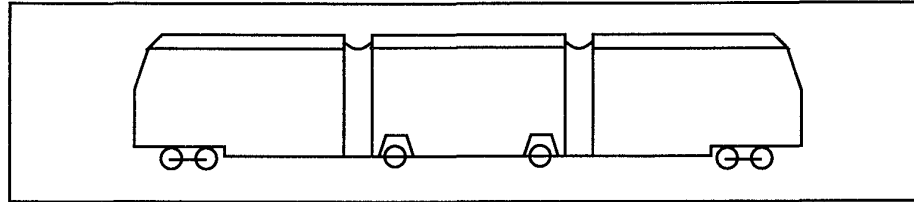
Doors: Three Double, One Single

Articulation: Floating

Body Material: Welded Steel

Buff Load: N/A

Concept Schematic



RUNNING GEAR

Axle Arrangement: Bo'1'1'Bo'

Power Wheel Diameter: 590 mm (23.2 in)

Power Gear: Conventional bi-motor

Trailer Wheel Diameter: 590 mm (23.2 in)

Trailer Gear: Single-axle conventional wheelset
steered by articulation

Track Gauge: 1435 mm (56.5 in)

Min Curve Radius: 20 m (65.6 ft)

Max Speed: 80 km/h (50 mph)

PROPULSION

Propulsion Technology: AC

Line Voltage: 750 V

Number of Motors: 4

Total Power: 400 kW (536 hp)

Specific Power: 11.5 kW/tonne (14 hp/ton)

BRAKES

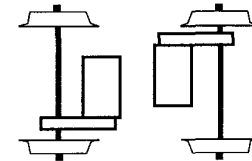
1. Combined Regenerative and Rheostatic
2. Rail Brakes
3. Disc Brakes

PRICE DATA

Cost Density: \$37,860 \$DM/m²

Vehicle Cost: N/A

Powered Running Gear



Trailing Running Gear



City/Authority: Dresden
(Germany)

Manufacturers: Duewag
ABB

Vehicle Type: 6MGT

Category: 2

Ordered: 20

Year of Delivery: N/A

CHARACTERISTICS

Car Length: 40.5 m (132.9 ft)

Car Width: 2.4 m (7.9 ft)

Low Floor Area: 63.5%

Floor Height

High: 600 mm (23.6 in)

Low: 350 mm (13.8 in)

Weight: 42 tonnes (92,600 lbs)

Specific Weight: 432 kg/m² (88 lb/ft²)

Seats: 119

Standees: 150 @ 4 pass/m²

CONSTRUCTION

Travel Direction: Unidirectional

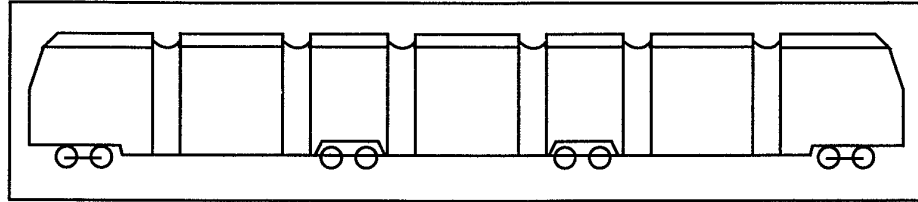
Doors: Four Double, One Single

Articulation: Floating

Body Material: N/A

Buff Load: N/A

Concept Schematic



RUNNING GEAR

Axle Arrangement: Bo'22Bo'

Power Wheel Diameter: 590 mm (23.2 in)

Power Gear: Conventional bi-motor

Trailer Wheel Diameter: 590 mm (23.2 in)

Trailer Gear: Four independent wheel trailer truck

Track Gauge: 1000 mm (39.4 in)

Min Curve Radius: 15 m (49.2 ft)

Max Speed: 70 km/h (44 mph)

PROPULSION

Propulsion Technology: AC

Line Voltage: 600 V

Number of Motors: 4

Total Power: 320 kW (429 hp)

Specific Power: 7.6 kW/tonne (9.3 hp/ton)

BRAKES

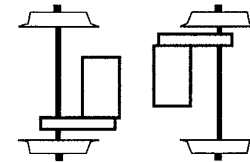
N/A

PRICE DATA

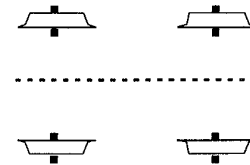
Cost Density: N/A

Vehicle Cost: N/A

Powered Running Gear



Trailing Running Gear



City/Authority: Dusseldorf
(Germany)

Manufacturers: Duewag
Siemens

Vehicle Type: NGT6D

Category: 2

Ordered: 10

Year of Delivery: N/A

CHARACTERISTICS

Car Length: 28.62 m (93.9 ft)

Car Width: 2.3 m (7.5 ft)

Low Floor Area: 65%

Floor Height

High: 560 mm (22 in)

Low: 350 mm (13.8 in)

Weight: 31.5 tonnes (69,400 lbs)

Specific Weight: 479 kg/m² (99 lb/ft²)

Seats: 72

Standees: 100 @ 4 pass/m²

CONSTRUCTION

Travel Direction: Bidirectional

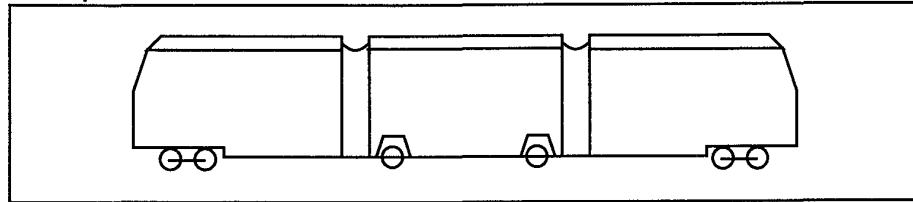
Doors: N/A

Articulation: N/A

Body Material: N/A

Buff Load: N/A

Concept Schematic



RUNNING GEAR

Axle Arrangement: Bo'1'1'Bo'

Power Wheel Diameter: 600 mm (23.6 in)

Power Gear: Conventional bi-motor

Trailer Wheel Diameter: 600 mm (23.6 in)

Trailer Gear: EEF wheelset

Track Gauge: 1435 mm (56.5 in)

Min Curve Radius: 15 m (49.2 ft)

Max Speed: 70 km/h (44 mph)

PROPULSION

Propulsion Technology: AC

Line Voltage: 600 V

Number of Motors: 4

Total Power: 360 kW (483 hp)

Specific Power: 11.4 kW/tonne (13.9 hp/ton)

BRAKES

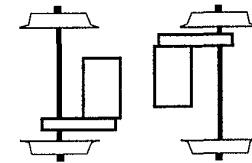
N/A

PRICE DATA

Cost Density: \$40,500 \$DM/m²

Vehicle Cost: N/A

Powered Running Gear



Trailing Running Gear



City/Authority: Erfurt
(Germany)

Manufacturers: Duewag
Siemens

Vehicle Type: MGT6D

Category: 2

Ordered: 4

Year of Delivery: N/A

CHARACTERISTICS

Car Length: 28.62 m (93.9 ft)

Car Width: 2.3 m (7.5 ft)

Low Floor Area: 65%

Floor Height
High: 560 mm (22 in)
Low: 350 mm (13.8 in)

Weight: 32 tonnes (70,500 lbs)

Specific Weight: 486 kg/m² (100 lb/ft²)

Seats: 72

Standees: 100 @ 4 pass/m²

CONSTRUCTION

Travel Direction: Bidirectional

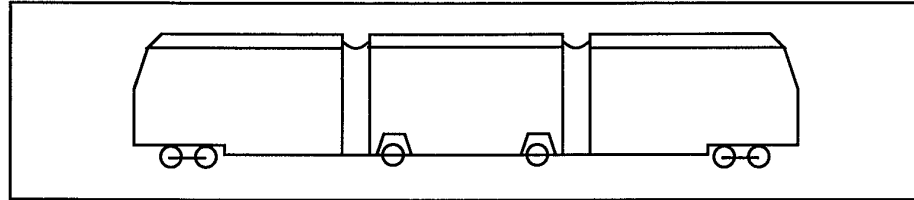
Doors: Three Double

Articulation: Floating

Body Material: Steel

Buff Load: N/A

Concept Schematic



RUNNING GEAR

Axle Arrangement: Bo'1'1'Bo'

Power Wheel Diameter: 575 mm (22.6 in)

Power Gear: Conventional bi-motor

Trailer Wheel Diameter: 575 mm (22.6 in)

Trailer Gear: EEF wheelset

Track Gauge: 1000 mm (39.4 in)

Min Curve Radius: 15 m (49.2 ft)

Max Speed: 70 km/h (44 mph)

PROPULSION

Propulsion Technology: AC

Line Voltage: 600 V

Number of Motors: 4

Total Power: 420 kW (563 hp)

Specific Power: 13.1 kW/tonne (16 hp/ton)

BRAKES

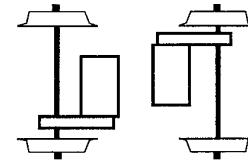
N/A

PRICE DATA

Cost Density: N/A

Vehicle Cost: N/A

Powered Running Gear



Trailing Running Gear



City/Authority: Geneva
(Switzerland)

Manufacturers: ACM Vevey

Vehicle Type: Be4/8 Intermediates

Category: 2

Ordered: 18

Year of Delivery: 1995

CHARACTERISTICS

Car Length: N/A

Car Width: N/A

Low Floor Area: N/A

Floor Height

High: N/A

Low: 350 mm (13.8 in)

Weight: N/A

Specific Weight: N/A

Seats: N/A

Standees: N/A

CONSTRUCTION

Travel Direction: Bidirectional

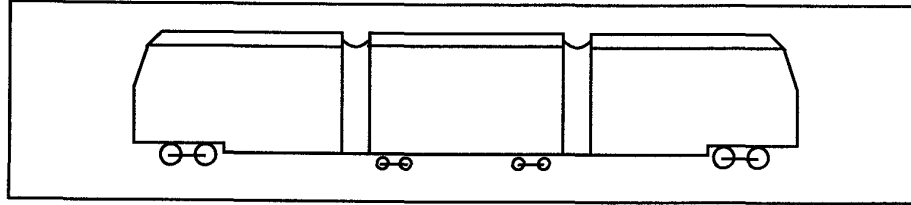
Doors: N/A

Articulation: Floating

Body Material: Welded Grade 52 Steel

Buff Load: N/A

Concept Schematic



RUNNING GEAR

Axle Arrangement: N/A

Power Wheel Diameter: N/A

Power Gear: None

Trailer Wheel Diameter: 410 mm (16.1 in)

Trailer Gear: Small wheel trailer truck

Track Gauge: 1000 mm (39.4 in)

Min Curve Radius: N/A

Max Speed: N/A

PROPULSION

Propulsion Technology: N/A

Line Voltage: N/A V

Number of Motors: N/A

Total Power: N/A

Specific Power: N/A

BRAKES

N/A

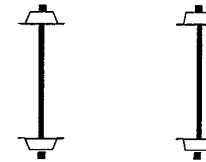
PRICE DATA

Cost Density: N/A

Vehicle Cost: \$SFr1,330,000

Powered Running Gear

Trailing Running Gear



City/Authority: Grenoble/ SEMITAG
(France)

Manufacturers: GEC Alsthom
De Dietrich

Vehicle Type: ZR 2000

Category: 2

Ordered: 38

Year of Delivery: 1997

CHARACTERISTICS

Car Length: 29.4 m (96.5 ft)

Car Width: 2.3 m (7.5 ft)

Low Floor Area: 65%

Floor Height

High: 875 mm (34.4 in)

Low: 345 mm (13.6 in)

Weight: 43.9 tonnes (96,800 lbs)

Specific Weight: 649 kg/m² (134 lb/ft²)

Seats: 54

Standees: 120 @ 4 pass/m²

CONSTRUCTION

Travel Direction: Bidirectional

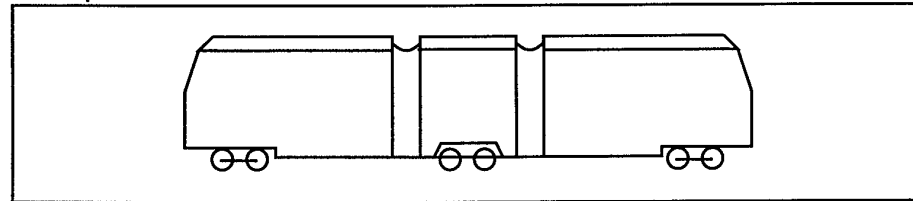
Doors: Four Double, One Single

Articulation: Floating

Body Material: N/A

Buff Load: N/A

Concept Schematic



RUNNING GEAR

Axle Arrangement: B'2'B'

Power Wheel Diameter: 660 mm (26 in)

Power Gear: Conventional monomotor

Trailer Wheel Diameter: 660 mm (26 in)

Trailer Gear: Independent wheels on two cranked axle trailer truck

Track Gauge: 1435 mm (56.5 in)

Min Curve Radius: 25 m (82 ft)

Max Speed: 70 km/h (44 mph)

PROPULSION

Propulsion Technology: DC

Line Voltage: 750 V

Number of Motors: 2

Total Power: 550 kW (738 hp)

Specific Power: 12.5 kW/tonne (15.3 hp/ton)

BRAKES

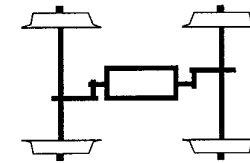
1. Regenerative
2. Hydraulic Disk
3. Magnetic Pads

PRICE DATA

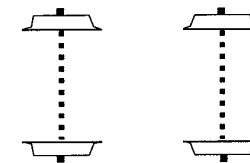
Cost Density: \$56,800 \$DM/m²

Vehicle Cost: N/A

Powered Running Gear



Trailing Running Gear



City/Authority: Geneva/ TPG
(Switzerland)

Manufacturers: ACM Vevey
Duewag
ABB

Vehicle Type: Be4/6

Category: 2

Ordered: 46

Year of Delivery: 1984

CHARACTERISTICS

Car Length: 21 m (68.9 ft)

Car Width: 2.3 m (7.5 ft)

Low Floor Area: 60.4%

Floor Height

High: 870 mm (34.3 in)

Low: 480 mm (18.9 in)

Weight: 27 tonnes (59,500 lbs)

Specific Weight: 559 kg/m² (115 lb/ft²)

Seats: 48

Standees: 88 @ 4 pass/m²

CONSTRUCTION

Travel Direction: Unidirectional

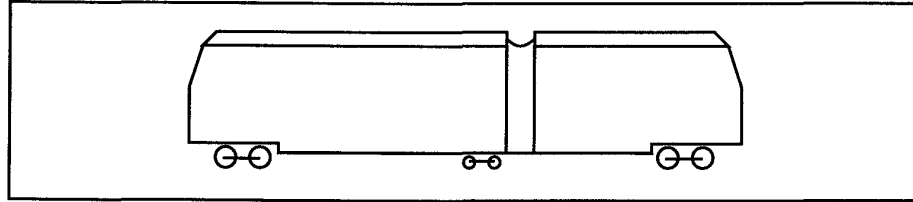
Doors: Four Double

Articulation: Floating

Body Material: Stainless Steel

Buff Load: N/A

Concept Schematic



RUNNING GEAR

Axle Arrangement: B'2'B'

Power Wheel Diameter: 660 mm (26 in)

Power Gear: Conventional monomotor

Trailer Wheel Diameter: 375 mm (14.8 in)

Trailer Gear: Small wheel trailer truck

Track Gauge: 1000 mm (39.4 in)

Min Curve Radius: 17.5 m (57.4 ft)

Max Speed: 60 km/h (37 mph)

PROPULSION

Propulsion Technology: DC

Line Voltage: 600 V

Number of Motors: 2

Total Power: 300 kW (402 hp)

Specific Power: 11.1 kW/tonne (13.5 hp/ton)

BRAKES

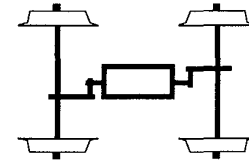
N/A

PRICE DATA

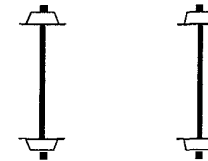
Cost Density: N/A

Vehicle Cost: \$US 2,350,000

Powered Running Gear



Trailing Running Gear



City/Authority: Grenoble/ SEMITAG
(France)

Manufacturers: GEC Alsthom
De Dietrich

Vehicle Type: ZR 2000

Category: 2

Ordered: 7

Year of Delivery: 1995

CHARACTERISTICS

Car Length: 29.4 m (96.5 ft)

Car Width: 2.3 m (7.5 ft)

Low Floor Area: 65%

Floor Height

High: 875 mm (34.4 in)

Low: 345 mm (13.6 in)

Weight: 43.9 tonnes (96,800 lbs)

Specific Weight: 649 kg/m² (134 lb/ft²)

Seats: 54

Standees: 120 @ 4 pass/m²

CONSTRUCTION

Travel Direction: Bidirectional

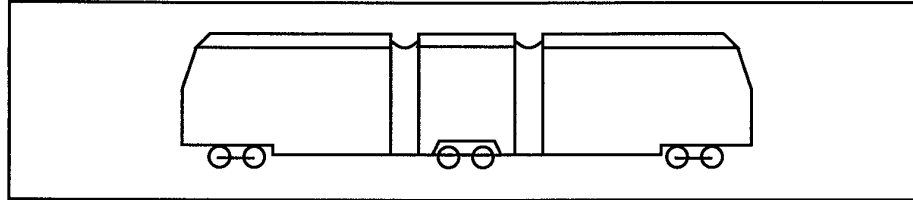
Doors: Four Double, One Single

Articulation: Floating

Body Material: N/A

Buff Load: N/A

Concept Schematic



RUNNING GEAR

Axle Arrangement: B'2'B'

Power Wheel Diameter: 660 mm (26 in)

Power Gear: Conventional bi-motor

Trailer Wheel Diameter: 660 mm (26 in)

Trailer Gear: Independent wheels on two cranked axle trailer truck

Track Gauge: 1435 mm (56.5 in)

Min Curve Radius: 25 m (82 ft)

Max Speed: 70 km/h (44 mph)

PROPULSION

Propulsion Technology: AC

Line Voltage: 750 V

Number of Motors: 4

Total Power: 1000 kW (1341 hp)

Specific Power: 22.8 kW/tonne (27.7 hp/ton)

BRAKES

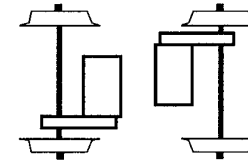
- 1. Regenerative
- 2. Hydraulic Disk
- 3. Magnetic Pads

PRICE DATA

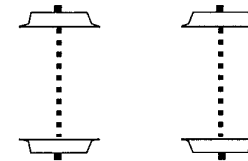
Cost Density: \$56,000 \$DM/m²

Vehicle Cost: \$FFr14,000,000

Powered Running Gear



Trailing Running Gear



City/Authority: Halle
(Germany)

Manufacturers: Duewag
Siemens
AEG

Vehicle Type: MGT6D

Category: 2

Ordered: 14

Year of Delivery: 1992

CHARACTERISTICS

Car Length: 28.62 m (93.9 ft)

Car Width: 2.3 m (7.5 ft)

Low Floor Area: 65%

Floor Height

High: 560 mm (22 in)

Low: 350 mm (13.8 in)

Weight: 32 tonnes (70,500 lbs)

Specific Weight: 486 kg/m² (100 lb/ft²)

Seats: 72

Standees: 100 @ 4 pass/m²

CONSTRUCTION

Travel Direction: Bidirectional

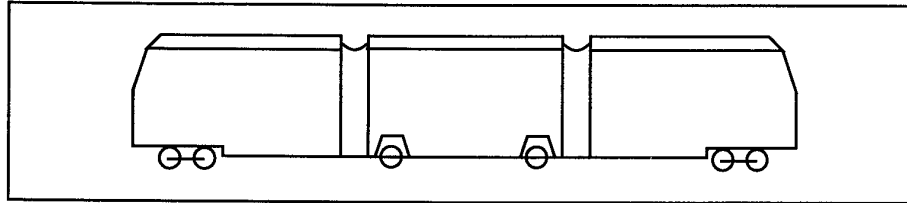
Doors: Three Double

Articulation: Floating

Body Material: Steel

Buff Load: N/A

Concept Schematic



RUNNING GEAR

Axle Arrangement: Bo'1'1'Bo'

Power Wheel Diameter: 575 mm (22.6 in)

Power Gear: Conventional bi-motor

Trailer Wheel Diameter: 575 mm (22.6 in)

Trailer Gear: EEF wheelset

Track Gauge: 1000 mm (39.4 in)

Min Curve Radius: 15 m (49.2 ft)

Max Speed: 70 km/h (44 mph)

PROPULSION

Propulsion Technology: AC

Line Voltage: 600 V

Number of Motors: 4

Total Power: 420 kW (563 hp)

Specific Power: 13.1 kW/tonne (16 hp/ton)

BRAKES

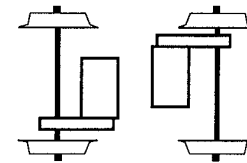
N/A

PRICE DATA

Cost Density: N/A

Vehicle Cost: N/A

Powered Running Gear



Trailing Running Gear



City/Authority: Heidelberg
(Germany)

Manufacturers: Duewag
ABB

Vehicle Type: MGT6D

Category: 2

Ordered: 12

Year of Delivery: 1994

CHARACTERISTICS

Car Length: 28.93 m (94.9 ft)

Car Width: 2.3 m (7.5 ft)

Low Floor Area: 63%

Floor Height

High: 540 mm (21.3 in)

Low: 350 mm (13.8 in)

Weight: 31.5 tonnes (69,400 lbs)

Specific Weight: 473 kg/m² (98 lb/ft²)

Seats: 64

Standees: 108 @ 4 pass/m²

CONSTRUCTION

Travel Direction: Bidirectional

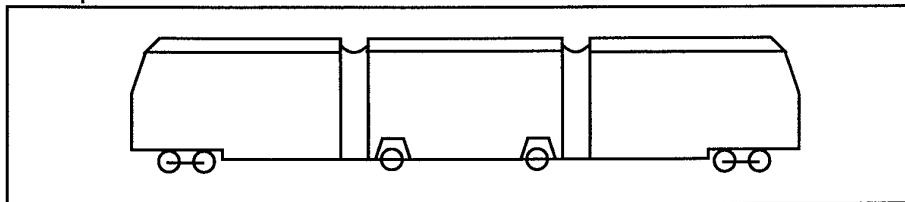
Doors: N/A

Articulation: N/A

Body Material: Steel

Buff Load: N/A

Concept Schematic



RUNNING GEAR

Axle Arrangement: Bo'1'1'Bo'

Power Wheel Diameter: 590 mm (23.2 in)

Power Gear: Conventional bi-motor

Trailer Wheel Diameter: 590 mm (23.2 in)

Trailer Gear: EEF wheelset

Track Gauge: 1000 mm (39.4 in)

Min Curve Radius: 15 m (49.2 ft)

Max Speed: 70 km/h (44 mph)

PROPULSION

Propulsion Technology: AC

Line Voltage: 600 V

Number of Motors: 4

Total Power: 320 kW (429 hp)

Specific Power: 10.2 kW/tonne (12.4 hp/ton)

BRAKES

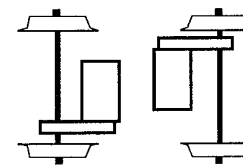
N/A

PRICE DATA

Cost Density: N/A

Vehicle Cost: N/A

Powered Running Gear



Trailing Running Gear



City/Authority: Karlsruhe
(Germany)

Manufacturers: Duewag
ABB

Vehicle Type: 70D/N

Category: 2

Ordered: 20

Year of Delivery: 1994

CHARACTERISTICS

Car Length: 28.82 m (94.6 ft)

Car Width: 2.65 m (8.7 ft)

Low Floor Area: 61%

Floor Height

High: 580 mm (22.8 in)

Low: 390 mm (15.4 in)

Weight: 34.5 tonnes (76,100 lbs)

Specific Weight: 452 kg/m² (92 lb/ft²)

Seats: 91

Standees: 100 @ 4 pass/m²

CONSTRUCTION

Travel Direction: Unidirectional

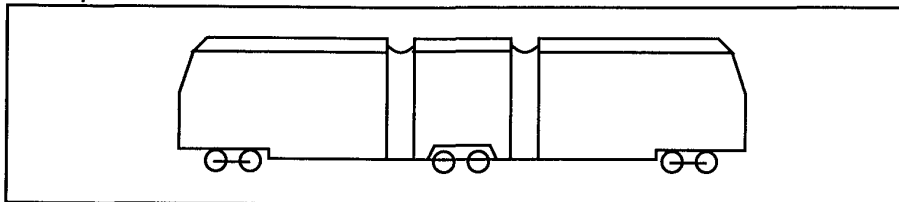
Doors: Four Double, One Single

Articulation: Supported

Body Material: N/A

Buff Load: N/A

Concept Schematic



RUNNING GEAR

Axle Arrangement: Bo'2Bo'

Power Wheel Diameter: 590 mm (23.2 in)

Power Gear: Conventional bi-motor

Trailer Wheel Diameter: 590 mm (23.2 in)

Trailer Gear: Four independent wheel trailer truck

Track Gauge: 1435 mm (56.5 in)

Min Curve Radius: N/A

Max Speed: 80 km/h (50 mph)

PROPULSION

Propulsion Technology: AC

Line Voltage: 750 V

Number of Motors: 4

Total Power: 500 kW (671 hp)

Specific Power: 14.5 kW/tonne (17.6 hp/ton)

BRAKES

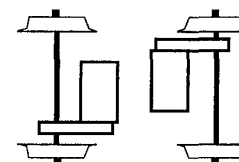
N/A

PRICE DATA

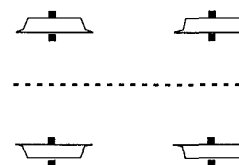
Cost Density: N/A

Vehicle Cost: N/A

Powered Running Gear



Trailing Running Gear



City/Authority: Kassel/ KVG
(Germany)

Manufacturers: Duewag
AEG-Westinghouse
Siemens

Vehicle Type: NGT6C

Category: 2

Ordered: 25

Year of Delivery: 1990

CHARACTERISTICS

Car Length: 28.75 m (94.3 ft)

Car Width: 2.3 m (7.5 ft)

Low Floor Area: 70%

Floor Height

High: 700 mm (27.6 in)

Low: 350 mm (13.8 in)

Weight: 30.2 tonnes (66,600 lbs)

Specific Weight: 457 kg/m² (94 lb/ft²)

Seats: 80

Standees: 105 @ 4 pass/m²

CONSTRUCTION

Travel Direction: Unidirectional

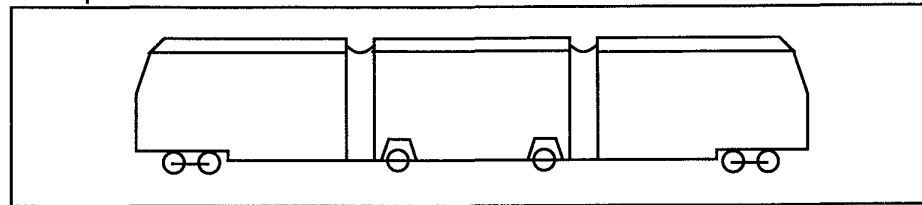
Doors: Four Double, One Single

Articulation: Floating

Body Material: Steel

Buff Load: N/A

Concept Schematic



RUNNING GEAR

Axle Arrangement: B'1'1'B'

Power Wheel Diameter: 560 mm (22 in)

Power Gear: Conventional monomotor

Trailer Wheel Diameter: 560 mm (22 in)

Trailer Gear: EEF wheelset

Track Gauge: 1435 mm (56.5 in)

Min Curve Radius: 15 m (49.2 ft)

Max Speed: 70 km/h (44 mph)

PROPULSION

Propulsion Technology: DC

Line Voltage: 600 V

Number of Motors: 2

Total Power: 360 kW (483 hp)

Specific Power: 11.9 kW/tonne (14.5 hp/ton)

BRAKES

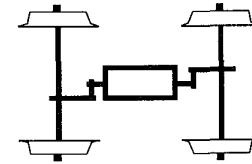
1. Hydraulic

PRICE DATA

Cost Density: \$33,000 \$DM/m²

Vehicle Cost: N/A

Powered Running Gear



Trailing Running Gear



City/Authority: Leipzig
(Germany)

Manufacturers: Duewag
ABB

Vehicle Type: 8NGT

Category: 2

Ordered: 25

Year of Delivery: 1994

CHARACTERISTICS

Car Length: 27.8 m (91.2 ft)

Car Width: 2.2 m (7.2 ft)

Low Floor Area: 61%

Floor Height

High: 560 mm (22 in)

Low: 300 mm (11.8 in)

Weight: 32 tonnes (70,500 lbs)

Specific Weight: 523 kg/m² (107 lb/ft²)

Seats: 77

Standees: 104 @ 4 pass/m²

CONSTRUCTION

Travel Direction: N/A

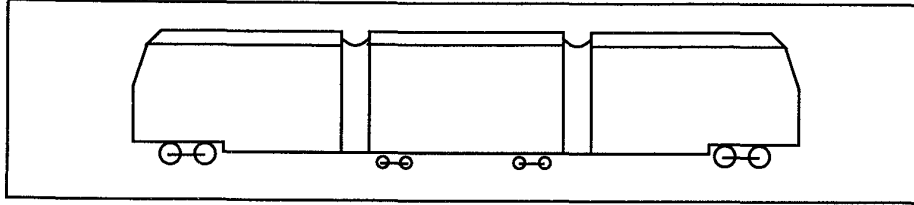
Doors: N/A

Articulation: N/A

Body Material: N/A

Buff Load: N/A

Concept Schematic



RUNNING GEAR

Axle Arrangement: Bo'2'2'Bo'

Power Wheel Diameter: 590 mm (23.2 in)

Power Gear: Conventional bi-motor

Trailer Wheel Diameter: 410 mm (16.1 in)

Trailer Gear: Small wheel trailer truck

Track Gauge: 1458 mm (57.4 in)

Min Curve Radius: N/A

Max Speed: 70 km/h (44 mph)

PROPULSION

Propulsion Technology: AC

Line Voltage: 600 V

Number of Motors: 4

Total Power: 320 kW (429 hp)

Specific Power: 10.0 kW/tonne (12.2 hp/ton)

BRAKES

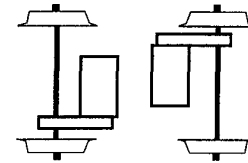
N/A

PRICE DATA

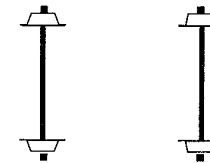
Cost Density: N/A

Vehicle Cost: N/A

Powered Running Gear



Trailing Running Gear



City/Authority: Magdeburg
(Germany)

Manufacturers: LHB
Deutsche Waggonbau AG
ABB

Vehicle Type: NGT 8D

Category: 2

Ordered: 120

Year of Delivery: 1995

CHARACTERISTICS

Car Length: 29.0 m (95.1 ft)

Car Width: 2.3 m (7.5 ft)

Low Floor Area: 60%

Floor Height

High: 570 mm (22.4 in)

Low: 350 mm (13.8 in)

Weight: 34 tonnes (75,000 lbs)

Specific Weight: 510 kg/m² (105 lb/ft²)

Seats: 71

Standees: 96 @ 4 pass/m²

CONSTRUCTION

Travel Direction: Unidirectional

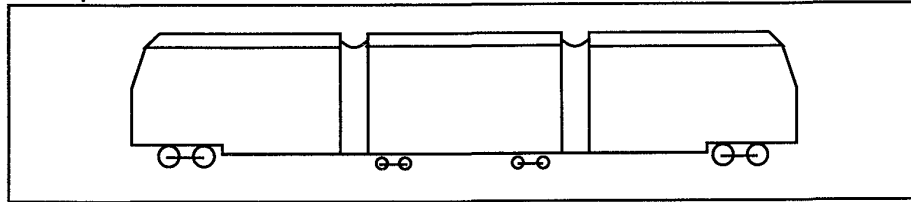
Doors: Three Double, Two Single

Articulation: Floating

Body Material: Steel

Buff Load: N/A

Concept Schematic



RUNNING GEAR

Axle Arrangement: Bo'2'2'Bo'

Power Wheel Diameter: 590 mm (23.2 in)

Power Gear: Conventional bi-motor

Trailer Wheel Diameter: 410 mm (16.1 in)

Trailer Gear: Small wheel trailer truck

Track Gauge: 1435 mm (56.5 in)

Min Curve Radius: N/A

Max Speed: 70 km/h (44 mph)

PROPULSION

Propulsion Technology: AC

Line Voltage: 600 V

Number of Motors: 4

Total Power: 320 kW (429 hp)

Specific Power: 9.4 kW/tonne (11.4 hp/ton)

BRAKES

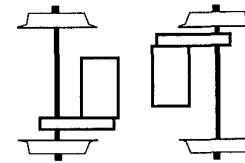
N/A

PRICE DATA

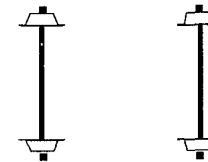
Cost Density: N/A

Vehicle Cost: N/A

Powered Running Gear



Trailing Running Gear



City/Authority: Mannheim
(Germany)

Manufacturers: Duewag
ABB

Vehicle Type: 6MGT

Category: 2

Ordered: 64

Year of Delivery: 1994

CHARACTERISTICS

Car Length: 29.9 m (98.1 ft)

Car Width: 2.4 m (7.9 ft)

Low Floor Area: 63.5%

Floor Height

High: 600 mm (23.6 in)

Low: 350 mm (13.8 in)

Weight: 33 tonnes (72,800 lbs)

Specific Weight: 460 kg/m² (94 lb/ft²)

Seats: 86

Standees: 104 @ 4 pass/m²

CONSTRUCTION

Travel Direction: Unidirectional

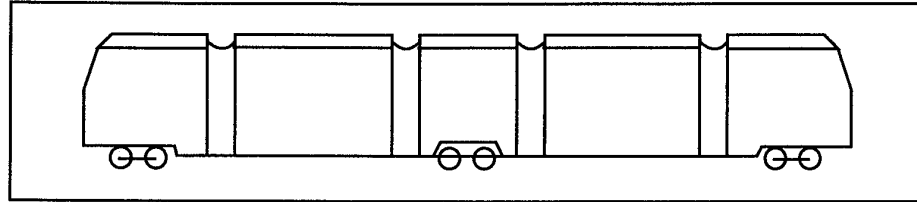
Doors: Four Double, One Single

Articulation: Floating

Body Material: N/A

Buff Load: N/A

Concept Schematic



RUNNING GEAR

Axle Arrangement: Bo'2Bo'

Power Wheel Diameter: 590 mm (23.2 in)

Power Gear: Conventional bi-motor

Trailer Wheel Diameter: 590 mm (23.2 in)

Trailer Gear: Four independent wheel trailer truck

Track Gauge: 1000 mm (39.4 in)

Min Curve Radius: 15 m (49.2 ft)

Max Speed: 70 km/h (44 mph)

PROPULSION

Propulsion Technology: AC

Line Voltage: 600 V

Number of Motors: 4

Total Power: 320 kW (429 hp)

Specific Power: 9.7 kW/tonne (11.8 hp/ton)

BRAKES

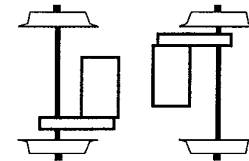
N/A

PRICE DATA

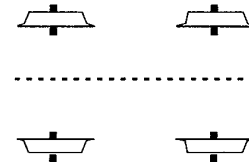
Cost Density: \$48,800 \$DM/m²

Vehicle Cost: N/A

Powered Running Gear



Trailing Running Gear



City/Authority: Mannheim
(Germany)

Manufacturers: Duewag
ABB

Vehicle Type: 6MGT

Category: 2

Ordered: 5

Year of Delivery: 1994

CHARACTERISTICS

Car Length: 40.5 m (132.9 ft)

Car Width: 2.4 m (7.9 ft)

Low Floor Area: 63.5%

Floor Height
High: 600 mm (23.6 in)
Low: 350 mm (13.8 in)

Weight: 42 tonnes (92,600 lbs)

Specific Weight: 432 kg/m² (88 lb/ft²)

Seats: 119

Standees: 150 @ 4 pass/m²

CONSTRUCTION

Travel Direction: Unidirectional

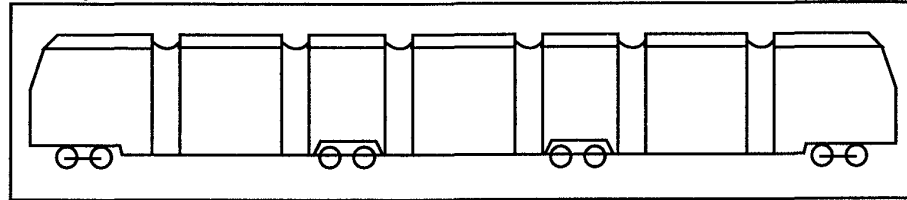
Doors: Four Double, One Single

Articulation: Floating

Body Material: N/A

Buff Load: N/A

Concept Schematic



RUNNING GEAR

Axle Arrangement: Bo'22Bo'

Power Wheel Diameter: 590 mm (23.2 in)

Power Gear: Conventional bi-motor

Trailer Wheel Diameter: 590 mm (23.2 in)

Trailer Gear: Four independent wheel trailer truck

Track Gauge: 1000 mm (39.4 in)

Min Curve Radius: 15 m (49.2 ft)

Max Speed: 70 km/h (44 mph)

PROPULSION

Propulsion Technology: AC

Line Voltage: 600 V

Number of Motors: 4

Total Power: 320 kW (429 hp)

Specific Power: 7.6 kW/tonne (9.3 hp/ton)

BRAKES

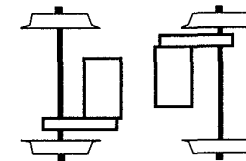
N/A

PRICE DATA

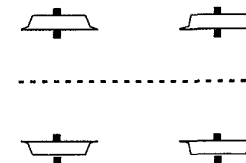
Cost Density: \$44,300 \$DM/m²

Vehicle Cost: N/A

Powered Running Gear



Trailing Running Gear



City/Authority: Mannheim
(Germany)

Manufacturers: ABB Henschel
LHB

Vehicle Type: 6NGT/ Variotram

Category: 2

Ordered: 2

Year of Delivery: 1996

CHARACTERISTICS

Car Length: N/A

Car Width: N/A

Low Floor Area: 70%

Floor Height

High: N/A

Low: 290 mm (11.4 in)

Weight: N/A

Specific Weight: N/A

Seats: N/A

Standees: N/A

CONSTRUCTION

Travel Direction: Unidirectional

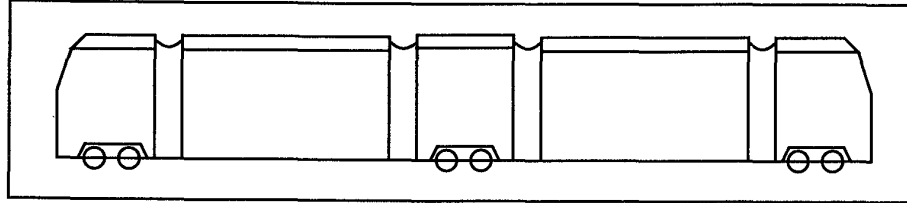
Doors: N/A

Articulation: Floating

Body Material: N/A

Buff Load: N/A

Concept Schematic



RUNNING GEAR

Axle Arrangement: N/A

Power Wheel Diameter: N/A

Power Gear: Conventional bi-motor

Trailer Wheel Diameter: N/A

Trailer Gear: Four independent wheel trailer truck

Track Gauge: 1000 mm (39.4 in)

Min Curve Radius: N/A

Max Speed: N/A

PROPULSION

Propulsion Technology: AC

Line Voltage: N/A

Number of Motors: N/A

Total Power: N/A

Specific Power: N/A

BRAKES

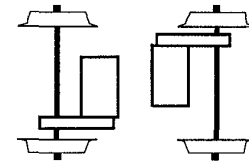
N/A

PRICE DATA

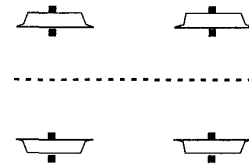
Cost Density: \$42,650 \$DM/m²

Vehicle Cost: N/A

Powered Running Gear



Trailing Running Gear



City/Authority: Mulheim
(Germany)

Manufacturers: Duewag
Siemens

Vehicle Type: MGT6D

Category: 2

Ordered: 4

Year of Delivery: N/A

CHARACTERISTICS

Car Length: 28.62 m (93.9 ft)

Car Width: 2.3 m (7.5 ft)

Low Floor Area: 65%

Floor Height

High: 560 mm (22 in)

Low: 350 mm (13.8 in)

Weight: 32 tonnes (70,500 lbs)

Specific Weight: 486 kg/m² (100 lb/ft²)

Seats: 72

Standeeds: 100 @ 4 pass/m²

CONSTRUCTION

Travel Direction: Bidirectional

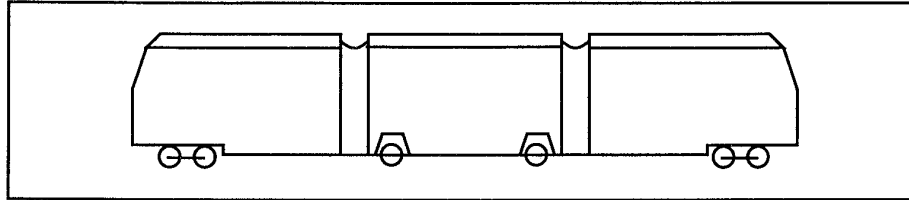
Doors: Three Double

Articulation: Floating

Body Material: Steel

Buff Load: N/A

Concept Schematic



RUNNING GEAR

Axle Arrangement: Bo'1'1'Bo'

Power Wheel Diameter: 575 mm (22.6 in)

Power Gear: Conventional bi-motor

Trailer Wheel Diameter: 575 mm (22.6 in)

Trailer Gear: EEF wheelset

Track Gauge: 1000 mm (39.4 in)

Min Curve Radius: 15 m (49.2 ft)

Max Speed: 70 km/h (44 mph)

PROPULSION

Propulsion Technology: AC

Line Voltage: 600 V

Number of Motors: 4

Total Power: 420 kW (563 hp)

Specific Power: 13.1 kW/tonne (16 hp/ton)

BRAKES

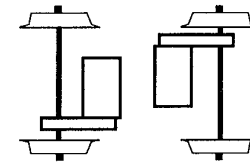
N/A

PRICE DATA

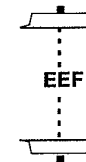
Cost Density: N/A

Vehicle Cost: N/A

Powered Running Gear



Trailing Running Gear



City/Authority: Paris/ SEMITAG
(France)

Manufacturers: GEC Alstom
De Dietrich

Vehicle Type: ZR 2000

Category: 2

Ordered: 17

Year of Delivery: N/A

CHARACTERISTICS

Car Length: 29.4 m (96.5 ft)

Car Width: 2.3 m (7.5 ft)

Low Floor Area: 65%

Floor Height

High: 875 mm (34.4 in)

Low: 345 mm (13.6 in)

Weight: 43.9 tonnes (96,800 lbs)

Specific Weight: 649 kg/m² (134 lb/ft²)

Seats: 54

Standees: 120 @ 4 pass/m²

CONSTRUCTION

Travel Direction: Bidirectional

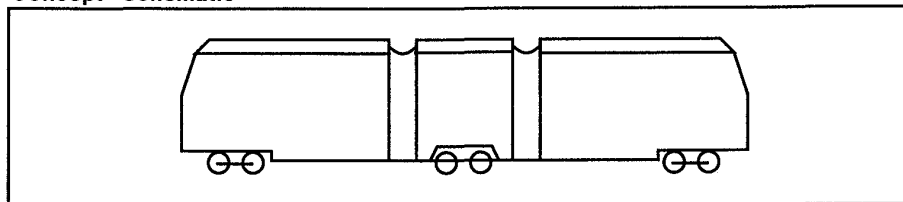
Doors: Four Double, One Single

Articulation: Floating

Body Material: N/A

Buff Load: N/A

Concept Schematic



RUNNING GEAR

Axle Arrangement: B'2'B'

Power Wheel Diameter: 660 mm (26 in)

Power Gear: Conventional monomotor

Trailer Wheel Diameter: 660 mm (26 in)

Trailer Gear: Independent wheels on two cranked axle trailer truck

Track Gauge: 1435 mm (56.5 in)

Min Curve Radius: 25 m (82 ft)

Max Speed: 70 km/h (44 mph)

PROPULSION

Propulsion Technology: DC

Line Voltage: 750 V

Number of Motors: 2

Total Power: 550 kW (738 hp)

Specific Power: 12.5 kW/tonne (15.3 hp/ton)

BRAKES

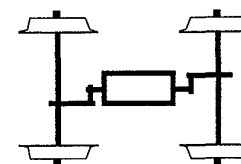
1. Regenerative
2. Hydraulic Disk
3. Magnetic Pads

PRICE DATA

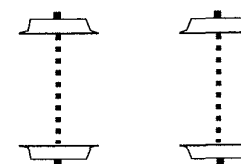
Cost Density: \$56,000 \$DM/m²

Vehicle Cost: \$US 2,400,000

Powered Running Gear



Trailing Running Gear



City/Authority: Portland
(United States)

Manufacturers: Siemens- Duewag
Siemens

Vehicle Type: N/A

Category: 2

Ordered: 46

Year of Delivery: 1995

CHARACTERISTICS

Car Length: 28.04 m (92 ft)

Car Width: 2.654 m (8.7 ft)

Low Floor Area: 66%

Floor Height

High: 980 mm (38.6 in)

Low: 355 mm (14 in)

Weight: 44 tonnes (97,000 lbs)

Specific Weight: 591 kg/m² (121 lb/ft²)

Seats: 72

Standees: 116 @ 4 pass/m²

CONSTRUCTION

Travel Direction: Bidirectional

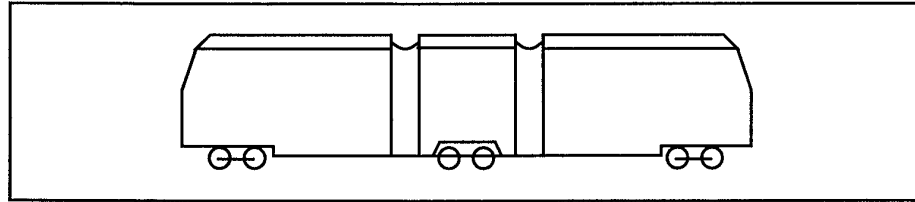
Doors: Four Double

Articulation: Floating

Body Material: Corten Steel

Buff Load: 78 tonnes (171,990 lbs)

Concept Schematic



RUNNING GEAR

Axle Arrangement: Bo'2Bo'

Power Wheel Diameter: 711 mm (28 in)

Power Gear: Conventional bi-motor

Trailer Wheel Diameter: 660 mm (26 in)

Trailer Gear: Independent wheels on two cranked axle trailer truck

Track Gauge: 1435 mm (56.5 in)

Min Curve Radius: 25 m (82 ft)

Max Speed: 88 km/h (55 mph)

PROPULSION

Propulsion Technology: AC

Line Voltage: 750 V

Number of Motors: 4

Total Power: 560 kW (751 hp)

Specific Power: 12.7 kW/tonne (15.5 hp/ton)

BRAKES

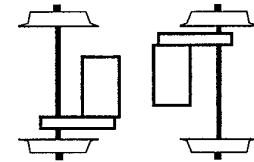
Hydraulic

PRICE DATA

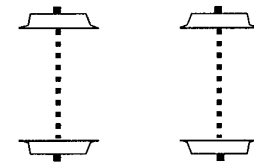
Cost Density: N/A

Vehicle Cost: US\$2,340,000

Powered Running Gear



Trailing Running Gear



City/Authority: Prototype
(Czech Rep.)

Manufacturers: CKD Tatra

Vehicle Type: RT6-N1

Category: 2

Ordered: 1

Year of Delivery: 1993

CHARACTERISTICS

Car Length: 26.28 m (86.2 ft)

Car Width: 2.44 m (8 ft)

Low Floor Area: 63%

Floor Height

High: 900 mm (35.4 in)

Low: 350 mm (13.8 in)

Weight: 32 tonnes (70,500 lbs)

Specific Weight: 499 kg/m² (102 lb/ft²)

Seats: 45

Standees: 93 @ 4 pass/m²

CONSTRUCTION

Travel Direction: Bidirectional

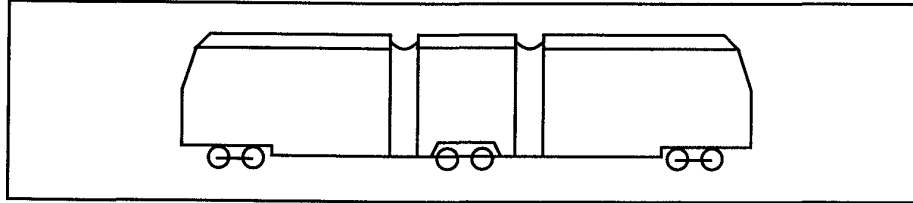
Doors: Four Double, Two Single

Articulation: Floating

Body Material: Welded Steel

Buff Load: N/A

Concept Schematic



RUNNING GEAR

Axle Arrangement: Bo'2Bo'

Power Wheel Diameter: 700 mm (27.6 in)

Power Gear: Conventional bi-motor

Trailer Wheel Diameter: 700 mm (27.6 in)

Trailer Gear: Four independent wheel trailer truck

Track Gauge: 1435 mm (56.5 in)

Min Curve Radius: 25 m (82 ft)

Max Speed: 80 km/h (50 mph)

PROPULSION

Propulsion Technology: DC

Line Voltage: 600 V

Number of Motors: 4

Total Power: 380 kW (510 hp)

Specific Power: 11.9 kW/tonne (14.5 hp/ton)

BRAKES

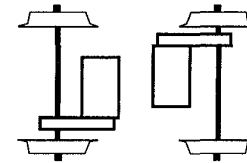
1. Regenerative
2. Hydraulic Disk
3. Rail Brakes

PRICE DATA

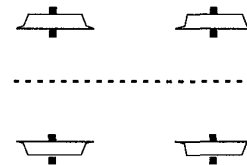
Cost Density: N/A

Vehicle Cost: N/A

Powered Running Gear



Trailing Running Gear



City/Authority: Rome/ ATAC
(Italy)

Manufacturers: Socimi

Vehicle Type: T8000

Category: 2

Ordered: 34

Year of Delivery: 1990

CHARACTERISTICS

Car Length: 21.2 m (69.6 ft)

Car Width: 2.3 m (7.5 ft)

Low Floor Area: 54%

Floor Height

High: 835 mm (32.9 in)

Low: 350 mm (13.8 in)

Weight: 29.7 tonnes (65,500 lbs)

Specific Weight: 609 kg/m² (125 lb/ft²)

Seats: 34

Standees: 101 @ 4 pass/m²

CONSTRUCTION

Travel Direction: Bidirectional

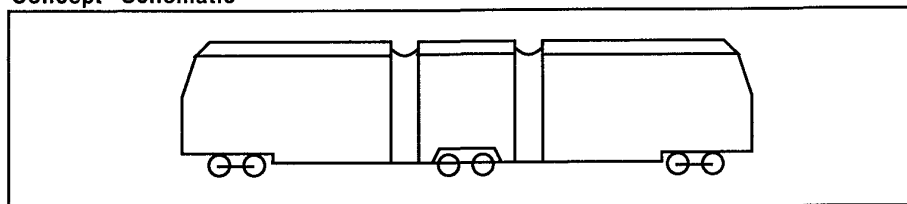
Doors: Four Double, One Single

Articulation: N/A

Body Material: N/A

Buff Load: N/A

Concept Schematic



RUNNING GEAR

Axle Arrangement: Bo'2Bo'

Power Wheel Diameter: 680 mm (26.8 in)

Power Gear: Conventional bi-motor

Trailer Wheel Diameter: 680 mm (26.8 in)

Trailer Gear: Four independent wheel trailer truck

Track Gauge: 1445 mm (56.9 in)

Min Curve Radius: 15 m (49.2 ft)

Max Speed: 70 km/h (44 mph)

PROPULSION

Propulsion Technology: AC

Line Voltage: 600 V

Number of Motors: 4

Total Power: 400 kW (536 hp)

Specific Power: 13.5 kW/tonne (16.4 hp/ton)

BRAKES

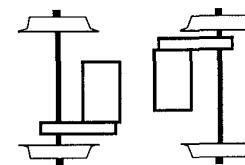
N/A

PRICE DATA

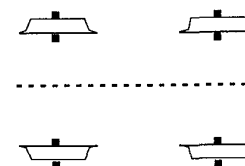
Cost Density: N/A

Vehicle Cost: N/A

Powered Running Gear



Trailing Running Gear



City/Authority: Rostock
(Germany)

Manufacturers: Duewag
ABB
Siemens

Vehicle Type: 6NGTWDE

Category: 2

Ordered: 50

Year of Delivery: 1994

CHARACTERISTICS

Car Length: 30.4 m (99.7 ft)

Car Width: 2.3 m (7.5 ft)

Low Floor Area: 50%

Floor Height

High: 560 mm (22 in)

Low: 350 mm (13.8 in)

Weight: 30.4 tonnes (67,000 lbs)

Specific Weight: 435 kg/m² (90 lb/ft²)

Seats: 91

Standees: 95 @ 4 pass/m²

CONSTRUCTION

Travel Direction: Bidirectional

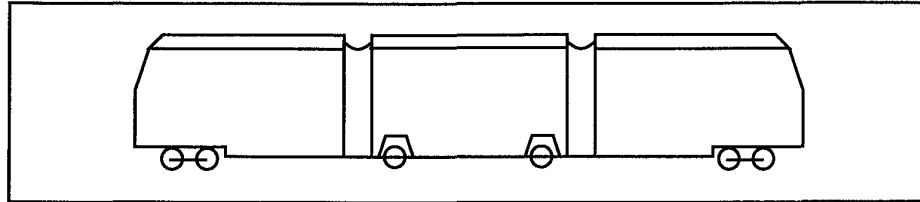
Doors: Three Double, Two Single

Articulation: Floating

Body Material: Steel

Buff Load: N/A

Concept Schematic



RUNNING GEAR

Axle Arrangement: Bo'1'1'Bo'

Power Wheel Diameter: 590 mm (23.2 in)

Power Gear: Conventional bi-motor

Trailer Wheel Diameter: 590 mm (23.2 in)

Trailer Gear: EEF wheelset

Track Gauge: 1435 mm (56.5 in)

Min Curve Radius: 15 m (49.2 ft)

Max Speed: 70 km/h (44 mph)

PROPULSION

Propulsion Technology: AC

Line Voltage: 600 V

Number of Motors: 4

Total Power: 320 kW (429 hp)

Specific Power: 10.5 kW/tonne (12.8 hp/ton)

BRAKES

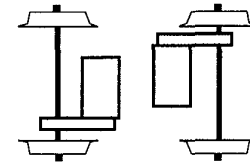
1. Electro-Hydraulic

PRICE DATA

Cost Density: N/A

Vehicle Cost: N/A

Powered Running Gear



Trailing Running Gear



City/Authority: Rouen/ SEMITAG
(France)

Manufacturers: GEC Alsthom
De Dietrich

Vehicle Type: ZR 2000

Category: 2

Ordered: 28

Year of Delivery: 1993

CHARACTERISTICS

Car Length: 29.4 m (96.5 ft)

Car Width: 2.3 m (7.5 ft)

Low Floor Area: 65%

Floor Height

High: 875 mm (34.4 in)

Low: 345 mm (13.6 in)

Weight: 43.9 tonnes (96,800 lbs)

Specific Weight: 649 kg/m² (134 lb/ft²)

Seats: 54

Standees: 120 @ 4 pass/m²

CONSTRUCTION

Travel Direction: Bidirectional

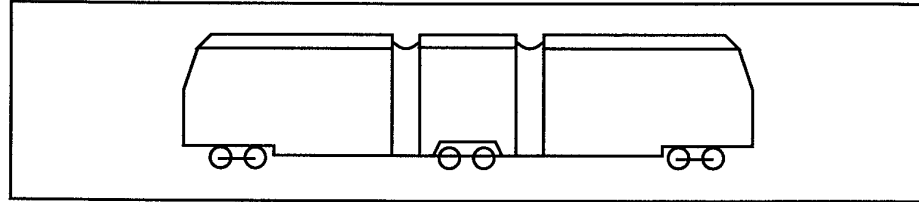
Doors: Four Double, One Single

Articulation: Floating

Body Material: N/A

Buff Load: N/A

Concept Schematic



RUNNING GEAR

Axle Arrangement: B'2'B'

Power Wheel Diameter: 660 mm (26 in)

Power Gear: Conventional monomotor

Trailer Wheel Diameter: 660 mm (26 in)

Trailer Gear: Independent wheels on two cranked
axle trailer truck

Track Gauge: 1435 mm (56.5 in)

Min Curve Radius: 25 m (82 ft)

Max Speed: 70 km/h (44 mph)

PROPULSION

Propulsion Technology: DC

Line Voltage: 750 V

Number of Motors: 2

Total Power: 550 kW (738 hp)

Specific Power: 12.5 kW/tonne (15.3 hp/ton)

BRAKES

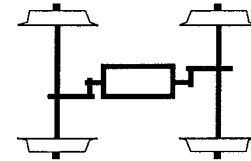
1. Regenerative
2. Hydraulic Disk
3. Magnetic Pads

PRICE DATA

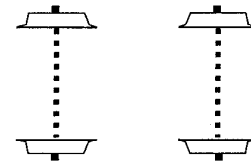
Cost Density: N/A

Vehicle Cost: N/A

Powered Running Gear



Trailing Running Gear



City/Authority: St. Etienne/ STAS
(France)

Manufacturers: GEC Alsthom
ACM Vevey
Duewag

Vehicle Type: Be4/6

Category: 2

Ordered: 25

Year of Delivery: 1991

CHARACTERISTICS

Car Length: 23.24 m (76.2 ft)

Car Width: 2.1 m (6.9 ft)

Low Floor Area: 59%

Floor Height

High: 710 mm (28 in)

Low: 350 mm (13.8 in)

Weight: 27.4 tonnes (60,400 lbs)

Specific Weight: 561 kg/m² (115 lb/ft²)

Seats: 43

Standees: 92 @ 4 pass/m²

CONSTRUCTION

Travel Direction: Unidirectional

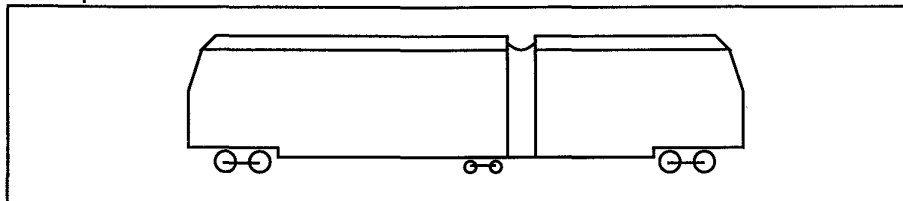
Doors: Four Double

Articulation: Floating

Body Material: Stainless Steel

Buff Load: N/A

Concept Schematic



RUNNING GEAR

Axle Arrangement: B'2'B'

Power Wheel Diameter: 560 mm (22 in)

Power Gear: Conventional monomotor

Trailer Wheel Diameter: 410 mm (16.1 in)

Trailer Gear: Small wheel trailer truck

Track Gauge: 1000 mm (39.4 in)

Min Curve Radius: 18 m (59.1 ft)

Max Speed: 70 km/h (44 mph)

PROPULSION

Propulsion Technology: DC

Line Voltage: 550 V

Number of Motors: 2

Total Power: 280 kW (375 hp)

Specific Power: 10.2 kW/tonne (12.4 hp/ton)

BRAKES

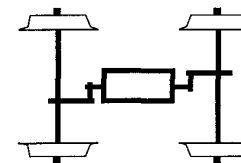
N/A

PRICE DATA

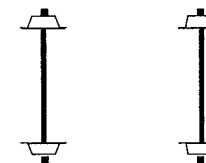
Cost Density: N/A

Vehicle Cost: N/A

Powered Running Gear



Trailing Running Gear



City/Authority: Swiss-Italian Railway/ FART
(Switzerland)

Manufacturers: ACM Vevey
ABB
SIG

Vehicle Type: ABe4/6

Category: 2

Ordered: 12

Year of Delivery: 1992

CHARACTERISTICS

Car Length: 30.3 m (99.4 ft)

Car Width: 2.65 m (8.7 ft)

Low Floor Area: 60%

Floor Height

High: 900 mm (35.4 in)

Low: 530 mm (20.9 in)

Weight: 42.5 tonnes (93,700 lbs)

Specific Weight: 529 kg/m² (108 lb/ft²)

Seats: 82

Standeers: 70 @ 4 pass/m²

CONSTRUCTION

Travel Direction: N/A

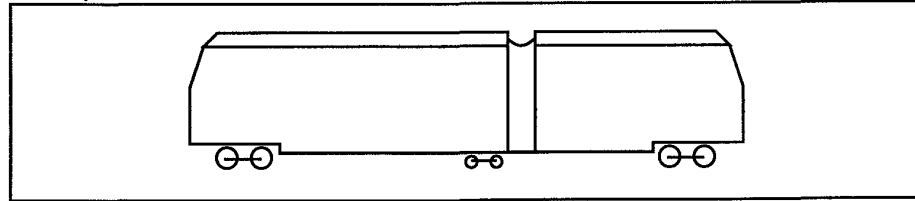
Doors: Two Double

Articulation: Floating

Body Material: N/A

Buff Load: N/A

Concept Schematic



RUNNING GEAR

Axle Arrangement: Bo'2'Bo'

Power Wheel Diameter: 750 mm (29.5 in)

Power Gear: Conventional bi-motor

Trailer Wheel Diameter: 600 mm (23.6 in)

Trailer Gear: Small wheel trailer truck

Track Gauge: 1000 mm (39.4 in)

Min Curve Radius: N/A

Max Speed: 80 km/h (50 mph)

PROPULSION

Propulsion Technology: AC

Line Voltage: 1350 V

Number of Motors: 4

Total Power: 600 kW (805 hp)

Specific Power: 14.1 kW/tonne (17.2 hp/ton)

BRAKES

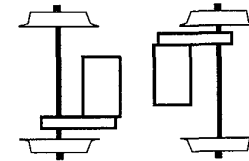
Electro-hydraulic

PRICE DATA

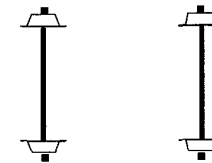
Cost Density: N/A

Vehicle Cost: N/A

Powered Running Gear



Trailing Running Gear



City/Authority: Turin/ ATM
(Italy)

Manufacturers: Fiat (Firema)

Vehicle Type: 5000

Category: 2

Ordered: 54

Year of Delivery: 1989

CHARACTERISTICS

Car Length: 22.2 m (72.8 ft)

Car Width: 2.3 m (7.5 ft)

Low Floor Area: 56%

Floor Height

High: 870 mm (34.3 in)

Low: 350 mm (13.8 in)

Weight: 30 tonnes (66,100 lbs)

Specific Weight: 588 kg/m² (121 lb/ft²)

Seats: 51

Standees: 92 @ 4 pass/m²

CONSTRUCTION

Travel Direction: Unidirectional

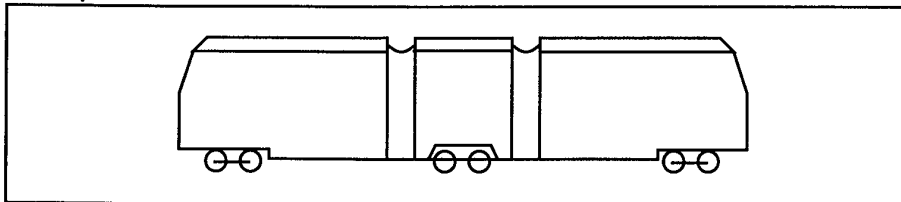
Doors: Four Double

Articulation: Supported

Body Material: N/A

Buff Load: N/A

Concept Schematic



RUNNING GEAR

Axle Arrangement: B'2'B

Power Wheel Diameter: 680 mm (26.8 in)

Power Gear: Conventional monomotor

Trailer Wheel Diameter: 680 mm (26.8 in)

Trailer Gear: Four independent wheel trailer truck

Track Gauge: 1435 mm (56.5 in)

Min Curve Radius: 16 m (52.5 ft)

Max Speed: 60 km/h (37 mph)

PROPULSION

Propulsion Technology: DC

Line Voltage: 600 V

Number of Motors: 2

Total Power: 300 kW (402 hp)

Specific Power: 10.0 kW/tonne (12.2 hp/ton)

BRAKES

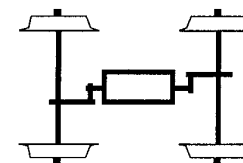
Regenerative

PRICE DATA

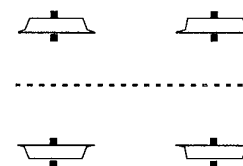
Cost Density: N/A

Vehicle Cost: N/A

Powered Running Gear



Trailing Running Gear



City/Authority: Val de Seine/ SEMITAG
(France)

Manufacturers: GEC Alstom
De Dietrich

Vehicle Type: ZR 2000

Category: 2

Ordered: 17

Year of Delivery: N/A

CHARACTERISTICS

Car Length: 29.4 m (96.5 ft)

Car Width: 2.3 m (7.5 ft)

Low Floor Area: 65%

Floor Height

High: 875 mm (34.4 in)

Low: 345 mm (13.6 in)

Weight: 43.9 tonnes (96,800 lbs)

Specific Weight: 649 kg/m² (134 lb/ft²)

Seats: 54

Standees: 120 @ 4 pass/m²

CONSTRUCTION

Travel Direction: Bidirectional

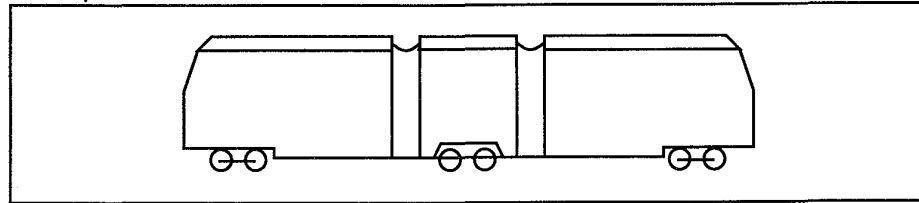
Doors: Four Double, One Single

Articulation: Floating

Body Material: N/A

Buff Load: N/A

Concept Schematic



RUNNING GEAR

Axle Arrangement: B'2'B'

Power Wheel Diameter: 660 mm (26 in)

Power Gear: Conventional monomotor

Trailer Wheel Diameter: 660 mm (26 in)

Trailer Gear: Independent wheels on two cranked axle trailer truck

Track Gauge: 1435 mm (56.5 in)

Min Curve Radius: 25 m (82 ft)

Max Speed: 70 km/h (44 mph)

PROPULSION

Propulsion Technology: DC

Line Voltage: 750 V

Number of Motors: 2

Total Power: 550 kW (738 hp)

Specific Power: 12.5 kW/tonne (15.3 hp/ton)

BRAKES

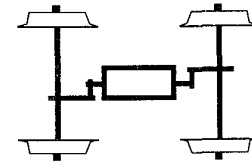
- 1. Regenerative
- 2. Hydraulic Disk
- 3. Magnetic Pads

PRICE DATA

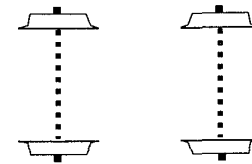
Cost Density: \$56,000 \$DM/m²

Vehicle Cost: N/A

Powered Running Gear



Trailing Running Gear



City/Authority: Valencia
(Spain)

Manufacturers: Duewag
Siemens
GEC Alsthom
CAF

Vehicle Type: N/A

Category: 2

Ordered: 24

Year of Delivery: 1994

CHARACTERISTICS

Car Length: 23.78 m (78 ft)

Car Width: 2.4 m (7.9 ft)

Low Floor Area: 62%

Floor Height

High: 560 mm (22 in)

Low: 350 mm (13.8 in)

Weight: 29.7 tonnes (65,500 lbs)

Specific Weight: 520 kg/m² (106 lb/ft²)

Seats: 65

Standees: 91 @ 4 pass/m²

CONSTRUCTION

Travel Direction: Unidirectional

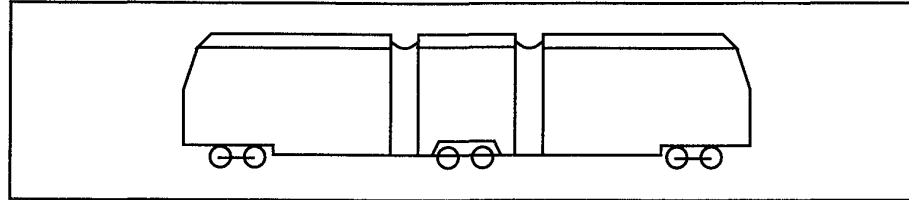
Doors: Four Double

Articulation: Floating

Body Material: Stainless Steel

Buff Load: N/A

Concept Schematic



RUNNING GEAR

Axle Arrangement: Bo'2Bo'

Power Wheel Diameter: 590 mm (23.2 in)

Power Gear: Conventional bi-motor

Trailer Wheel Diameter: 590 mm (23.2 in)

Trailer Gear: Four independent wheel trailer truck

Track Gauge: 1000 mm (39.4 in)

Min Curve Radius: 20 m (65.6 ft)

Max Speed: 65 km/h (40 mph)

PROPULSION

Propulsion Technology: AC

Line Voltage: 750 V

Number of Motors: 4

Total Power: 360 kW (483 hp)

Specific Power: 12.1 kW/tonne (14.8 hp/ton)

BRAKES

Regenerative

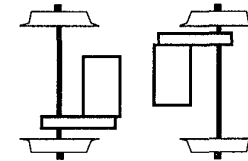
Electro-Hydraulic

PRICE DATA

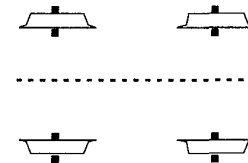
Cost Density: N/A

Vehicle Cost: N/A

Powered Running Gear



Trailing Running Gear



City/Authority: Vienna U-Bahn
(Austria)

Manufacturers: Bombardier (Rotax)
Duewag
Kiepe
Elin

Vehicle Type: T

Category: 2

Ordered: 68

Year of Delivery: 1992

CHARACTERISTICS

Car Length: 26.8 m (87.9 ft)

Car Width: 2.65 m (8.7 ft)

Low Floor Area: 60%

Floor Height

High: 530 mm (20.9 in)

Low: 440 mm (17.3 in)

Weight: 34.7 tonnes (76,500 lbs)

Specific Weight: 489 kg/m² (100 lb/ft²)

Seats: 58

Standees: 136 @ 4 pass/m²

CONSTRUCTION

Travel Direction: Bidirectional

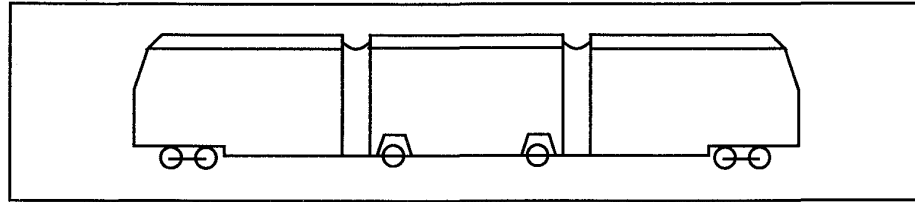
Doors: Three Double, One Single

Articulation: Floating

Body Material: Welded Steel

Buff Load: N/A

Concept Schematic



RUNNING GEAR

Axle Arrangement: Bo'1'1'Bo'

Power Wheel Diameter: 590 mm (23.2 in)

Power Gear: Conventional bi-motor

Trailer Wheel Diameter: 590 mm (23.2 in)

Trailer Gear: Single-axle conventional wheelset
steered by articulation

Track Gauge: 1435 mm (56.5 in)

Min Curve Radius: 20 m (65.6 ft)

Max Speed: 80 km/h (50 mph)

PROPULSION

Propulsion Technology: AC

Line Voltage: 750 V

Number of Motors: 4

Total Power: 400 kW (536 hp)

Specific Power: 11.5 kW/tonne (14 hp/ton)

BRAKES

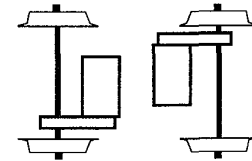
1. Combined Regenerative and Rheostatic
2. Rail Brakes
3. Disc Brakes

PRICE DATA

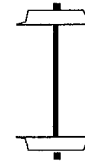
Cost Density: N/A

Vehicle Cost: N/A

Powered Running Gear



Trailing Running Gear



CATEGORY-3 LF-LRVs

City/Authority: Augsburg
(Germany)

Manufacturers: AEG (MAN)
Siemens
AEG

Vehicle Type: GT6M

Category: 3

Ordered: 1

Year of Delivery: 1993

CHARACTERISTICS

Car Length: 26.5 m (86.9 ft)

Car Width: 2.3 m (7.5 ft)

Low Floor Area: 100%

Floor Height

High: 350 mm (13.8 in)

Low: 300 mm (11.8 in)

Weight: 29.6 tonnes (65,300 lbs)

Specific Weight: 486 kg/m² (100 lb/ft²)

Seats: 60

Standees: 103 @ 4 pass/m²

CONSTRUCTION

Travel Direction: Unidirectional

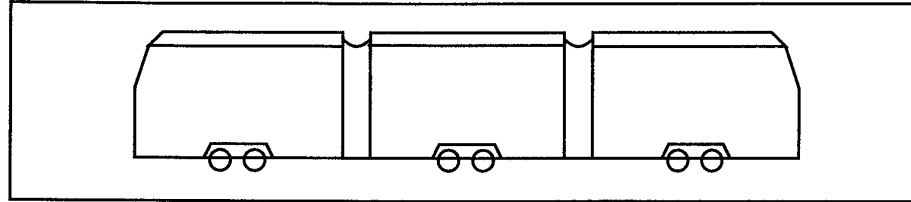
Doors: Four Double

Articulation: Floating

Body Material: Stainless Steel

Buff Load: 20 tonnes (44,100 lbs)

Concept Schematic



RUNNING GEAR

Axle Arrangement: 1A'A1'A1'

Power Wheel Diameter: 680 mm (26.8 in)

Power Gear: Independent wheels, one pair driven,
one pair free-wheeling

Trailer Wheel Diameter: N/A

Trailer Gear: N/A

Track Gauge: 1000 mm (39.4 in)

Min Curve Radius: 15 m (49.2 ft)

Max Speed: 70 km/h (44 mph)

PROPULSION

Propulsion Technology: AC

Line Voltage: 600 V

Number of Motors: 3

Total Power: 252 kW (338 hp)

Specific Power: 8.5 kW/tonne (10.4 hp/ton)

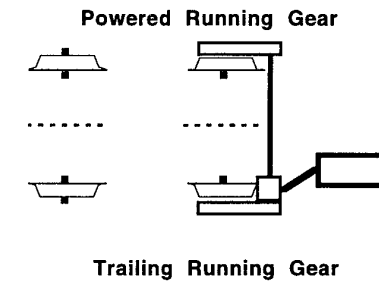
BRAKES

1. Regenerative
2. Spring Loaded Disc

PRICE DATA

Cost Density: N/A

Vehicle Cost: N/A



City/Authority: Berlin
(Germany)

Manufacturers: AEG (MAN)

Vehicle Type: GT6N

Category: 3

Ordered: 120

Year of Delivery: 1994

CHARACTERISTICS

Car Length: 26.5 m (86.9 ft)

Car Width: 2.3 m (7.5 ft)

Low Floor Area: 100%

Floor Height

High: 350 mm (13.8 in)

Low: 300 mm (11.8 in)

Weight: 26.8 tonnes (59,100 lbs)

Specific Weight: 440 kg/m² (91 lb/ft²)

Seats: 60

Standees: 103 @ 4 pass/m²

CONSTRUCTION

Travel Direction: Unidirectional

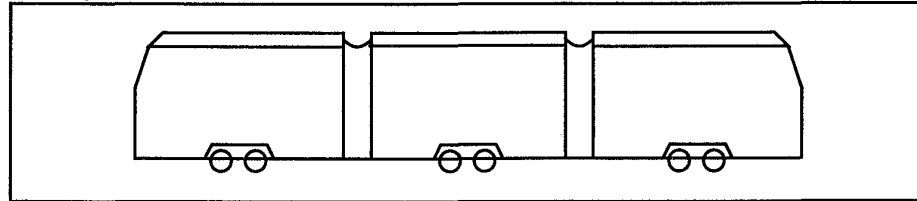
Doors: Four Double

Articulation: Floating

Body Material: Stainless Steel

Buff Load: 20 tonnes (44,100 lbs)

Concept Schematic



RUNNING GEAR

Axle Arrangement: 1A'A1'A1'

Power Wheel Diameter: 680 mm (26.8 in)

Power Gear: Independent wheels, one pair driven,
one pair free-wheeling

Trailer Wheel Diameter: N/A

Trailer Gear: N/A

Track Gauge: 1435 mm (56.5 in)

Min Curve Radius: 15 m (49.2 ft)

Max Speed: 70 km/h (44 mph)

PROPULSION

Propulsion Technology: AC

Line Voltage: 600 V

Number of Motors: 3

Total Power: 252 kW (338 hp)

Specific Power: 9.4 kW/tonne (11.4 hp/ton)

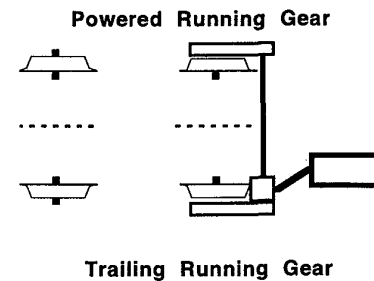
BRAKES

1. Regenerative
2. Spring Loaded Disc

PRICE DATA

Cost Density: N/A

Vehicle Cost: N/A



City/Authority: Bonn/SWB
(Germany)

Manufacturers: German Consortium (VDV)

Vehicle Type: GTW-ZR

Category: 3

Ordered: 1

Year of Delivery: 1991

CHARACTERISTICS

Car Length: 20.19 m (66.2 ft)

Car Width: 2.4 m (7.9 ft)

Low Floor Area: 100%

Floor Height

High: 350 mm (13.8 in)

Low: 290 mm (11.4 in)

Weight: 18.56 tonnes (40,900 lbs)

Specific Weight: 383 kg/m² (78 lb/ft²)

Seats: 51

Standees: 67 @ 4 pass/m²

CONSTRUCTION

Travel Direction: Bidirectional

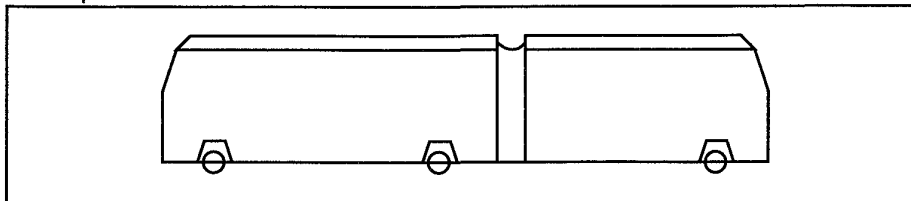
Doors: N/A

Articulation: N/A

Body Material: Aluminum

Buff Load: N/A

Concept Schematic



RUNNING GEAR

Axle Arrangement: A'A'1'

Power Wheel Diameter: 560 mm (22 in)

Power Gear: Motored EEF self-steering wheelset

Trailer Wheel Diameter: 560 mm (22 in)

Trailer Gear: EEF wheelset

Track Gauge: 1435 mm (56.5 in)

Min Curve Radius: 18 m (59.1 ft)

Max Speed: 70 km/h (44 mph)

PROPULSION

Propulsion Technology: AC

Line Voltage: 750 V

Number of Motors: 4

Total Power: 240 kW (322 hp)

Specific Power: 12.9 kW/tonne (15.7 hp/ton)

BRAKES

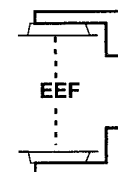
N/A

PRICE DATA

Cost Density: N/A

Vehicle Cost: N/A

Powered Running Gear



Trailing Running Gear



City/Authority: Braunschweig
(Germany)

Manufacturers: AEG (MAN)
LHB

Vehicle Type: GT6N

Category: 3

Ordered: 11

Year of Delivery: N/A

CHARACTERISTICS

Car Length: 26.5 m (86.9 ft)

Car Width: 2.3 m (7.5 ft)

Low Floor Area: 100%

Floor Height

High: 350 mm (13.8 in)

Low: 300 mm (11.8 in)

Weight: 26.8 tonnes (59,100 lbs)

Specific Weight: 440 kg/m² (91 lb/ft²)

Seats: 60

Standees: 103 @ 4 pass/m²

CONSTRUCTION

Travel Direction: Unidirectional

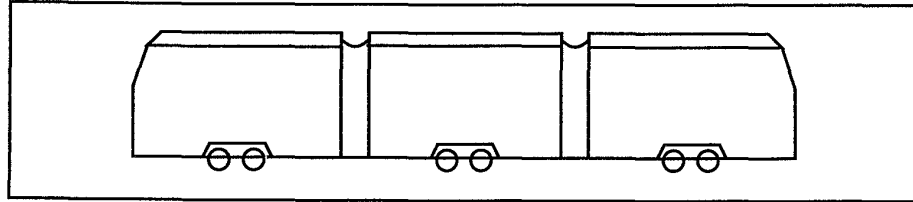
Doors: Four Double

Articulation: Floating

Body Material: Stainless Steel

Buff Load: 20 tonnes (44,100 lbs)

Concept Schematic



RUNNING GEAR

Axle Arrangement: 1A'A1'A1'

Power Wheel Diameter: 680 mm (26.8 in)

Power Gear: Independent wheels, one pair driven,
one pair free-wheeling

Trailer Wheel Diameter: N/A

Trailer Gear: N/A

Track Gauge: 1435 mm (56.5 in)

Min Curve Radius: 15 m (49.2 ft)

Max Speed: 70 km/h (44 mph)

PROPULSION

Propulsion Technology: AC

Line Voltage: 600 V

Number of Motors: 3

Total Power: 252 kW (338 hp)

Specific Power: 9.4 kW/tonne (11.4 hp/ton)

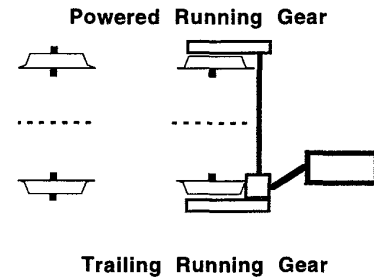
BRAKES

1. Regenerative
2. Spring Loaded Disc

PRICE DATA

Cost Density: N/A

Vehicle Cost: N/A



City/Authority: Bremen
(Germany)

Manufacturers: AEG (MAN)
AEG/Kiepe

Vehicle Type: GT6N

Category: 3

Ordered: 18

Year of Delivery: 1990

CHARACTERISTICS

Car Length: 26.5 m (86.9 ft)

Car Width: 2.3 m (7.5 ft)

Low Floor Area: 100%

Floor Height

High: 350 mm (13.8 in)

Low: 300 mm (11.8 in)

Weight: 26.8 tonnes (59,100 lbs)

Specific Weight: 440 kg/m² (91 lb/ft²)

Seats: 60

Standees: 103 @ 4 pass/m²

CONSTRUCTION

Travel Direction: Unidirectional

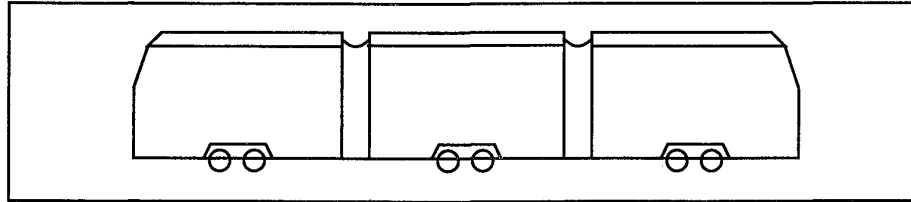
Doors: Four Double

Articulation: Floating

Body Material: Stainless Steel

Buff Load: 20 tonnes (44,100 lbs)

Concept Schematic



RUNNING GEAR

Axle Arrangement: 1A'A1'A1'

Power Wheel Diameter: 680 mm (26.8 in)

Power Gear: Independent wheels, one pair driven,
one pair free-wheeling

Trailer Wheel Diameter: N/A

Trailer Gear: N/A

Track Gauge: 1435 mm (56.5 in)

Min Curve Radius: 15 m (49.2 ft)

Max Speed: 70 km/h (44 mph)

PROPULSION

Propulsion Technology: AC

Line Voltage: 600 V

Number of Motors: 3

Total Power: 252 kW (338 hp)

Specific Power: 9.4 kW/tonne (11.4 hp/ton)

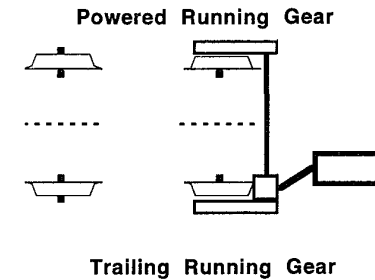
BRAKES

1. Regenerative
2. Spring Loaded Disc

PRICE DATA

Cost Density: N/A

Vehicle Cost: N/A



City/Authority: Bremen
(Germany)

Manufacturers: AEG (MAN)
AEG/Kiepe

Vehicle Type: GT8N

Category: 3

Ordered: 61

Year of Delivery: 1993

CHARACTERISTICS

Car Length: 35 m (114.8 ft)

Car Width: 2.3 m (7.5 ft)

Low Floor Area: 100%

Floor Height

High: 350 mm (13.8 in)

Low: 300 mm (11.8 in)

Weight: 34 tonnes (75,000 lbs)

Specific Weight: 422 kg/m² (87 lb/ft²)

Seats: 89

Standees: 137 @ 4 pass/m²

CONSTRUCTION

Travel Direction: Unidirectional

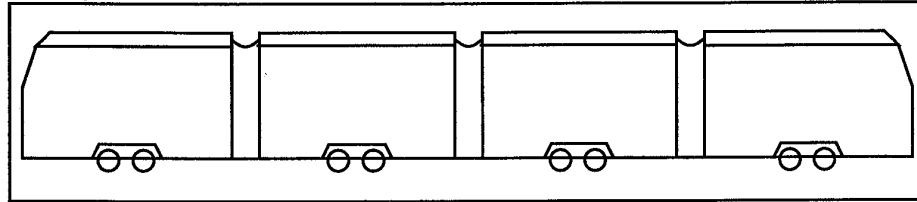
Doors: Five Double

Articulation: Floating

Body Material: Steel

Buff Load: 20 tonnes (44,100 lbs)

Concept Schematic



RUNNING GEAR

Axle Arrangement: 1A'1A'1A'1A'

Power Wheel Diameter: 680 mm (26.8 in)

Power Gear: Independent wheels, one pair driven,
one pair free-wheeling

Trailer Wheel Diameter: 680 mm (26.8 in)

Trailer Gear: N/A

Track Gauge: 1435 mm (56.5 in)

Min Curve Radius: 15 m (49.2 ft)

Max Speed: 70 km/h (44 mph)

PROPULSION

Propulsion Technology: AC

Line Voltage: 600 V

Number of Motors: 4

Total Power: 376 kW (504 hp)

Specific Power: 11.1 kW/tonne (13.4 hp/ton)

BRAKES

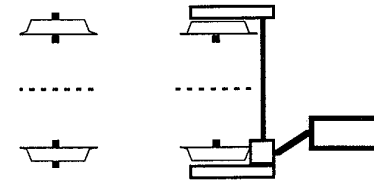
N/A

PRICE DATA

Cost Density: \$51,000 \$DM/m²

Vehicle Cost: N/A

Powered Running Gear



Trailing Running Gear

City/Authority: Brussels (Belgium)

Manufacturers: Bombardier (BN)
GEC Alstom
ACEC Transport

Vehicle Type: TRAM2000

Category: 3

Ordered: 51

Year of Delivery: 1994

CHARACTERISTICS

Car Length: 22.8 m (74.8 ft)

Car Width: 2.3 m (7.5 ft)

Low Floor Area: 100%

Floor Height

High: 350 mm (13.8 in)

Low: 350 mm (13.8 in)

Weight: 31.9 tonnes (70,300 lbs)

Specific Weight: 608 kg/m2 (125 lb/ft2)

Seats: 32

Standees: 95 @ 4 pass/m2

CONSTRUCTION

Travel Direction: Bidirectional

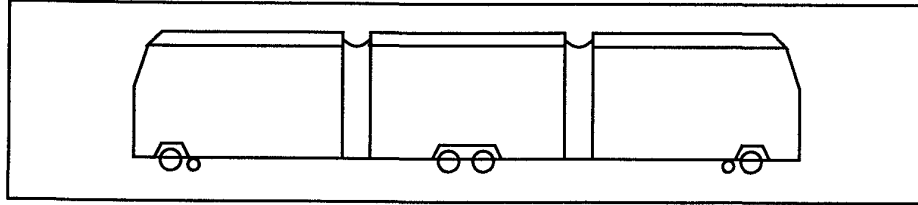
Doors: Two Double, Two Single

Articulation: Floating

Body Material: Bolted Aluminum w/Bonded Polyester

Buff Load: 40 tonnes (88,200 lbs)

Concept Schematic



RUNNING GEAR

Axle Arrangement: A'1'Bo1'A'

Power Wheel Diameter: 640 mm (25.2 in)

Power Gear: Articulated truck frame, two large hub motor-driven wheels, two small guiding wheels

Trailer Wheel Diameter: 375 mm (14.8 in)

Trailer Gear: Middle truck has independent wheels with hub motors

Track Gauge: 1435 mm (56.5 in)

Min Curve Radius: 17.5 m (57.4 ft)

Max Speed: 70 km/h (44 mph)

PROPULSION

Propulsion Technology: AC

Line Voltage: 600 V

Number of Motors: 8

Total Power: 352 kW (472 hp)

Specific Power: 11.0 kW/tonne (13.4 hp/ton)

BRAKES

- 1. Combined Regenerative/Rheostatic
- 2. Disc Brakes
- 3. Electro-Magnetic Track Brakes

PRICE DATA

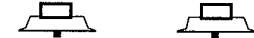
Cost Density: \$58,500 \$DM/m²

Vehicle Cost: \$BF 1,235,000

Powered Running Gear



Trailing Running Gear



City/Authority: Chemnitz
(Germany)

Manufacturers: ABB Henschel
LHB

Vehicle Type: 6NGT/ Variotram

Category: 3

Ordered: 53

Year of Delivery: 1993

CHARACTERISTICS

Car Length: 30.9 m (101.4 ft)

Car Width: 2.65 m (8.7 ft)

Low Floor Area: 100%

Floor Height

High: 350 mm (13.8 in)

Low: 290 mm (11.4 in)

Weight: 28.3 tonnes (62,400 lbs)

Specific Weight: 346 kg/m² (71 lb/ft²)

Seats: 88

Standees: 124 @ 4 pass/m²

CONSTRUCTION

Travel Direction: Unidirectional

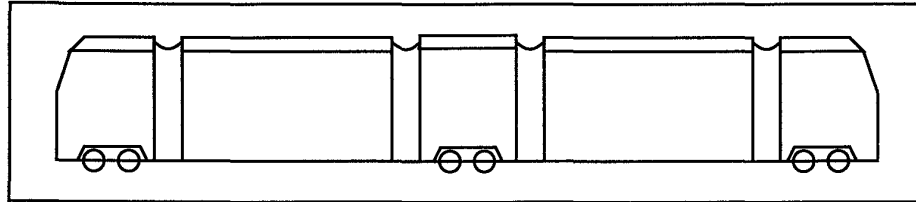
Doors: Six Double

Articulation: Floating

Body Material: N/A

Buff Load: 20 tonnes (44,100 lbs)

Concept Schematic



RUNNING GEAR

Axle Arrangement: Bo'2'Bo'

Power Wheel Diameter: 630 mm (24.8 in)

Power Gear: Four hub motor-driven, independent wheels

Trailer Wheel Diameter: 630 mm (24.8 in)

Trailer Gear: Four independent wheel trailer truck

Track Gauge: 1435 mm (56.5 in)

Min Curve Radius: 18 m (59.1 ft)

Max Speed: 70 km/h (44 mph)

PROPULSION

Propulsion Technology: AC

Line Voltage: 750 V

Number of Motors: 8

Total Power: 360 kW (483 hp)

Specific Power: 12.7 kW/tonne (15.5 hp/ton)

BRAKES

N/A

PRICE DATA

Cost Density: \$42,650 \$DM/m²

Vehicle Cost: \$US 2,060,000

Powered Running Gear



Trailing Running Gear



City/Authority: Dusseldorf/ RBG
(Germany)

Manufacturers: German Consortium (VDV)

Vehicle Type: GTW-ER

Category: 3

Ordered: 1

Year of Delivery: 1991

CHARACTERISTICS

Car Length: 20.19 m (66.2 ft)

Car Width: 2.4 m (7.9 ft)

Low Floor Area: 100%

Floor Height

High: 350 mm (13.8 in)

Low: 290 mm (11.4 in)

Weight: 17.75 tonnes (39,100 lbs)

Specific Weight: 366 kg/m² (75 lb/ft²)

Seats: 55

Standees: 59 @ 4 pass/m²

CONSTRUCTION

Travel Direction: Unidirectional

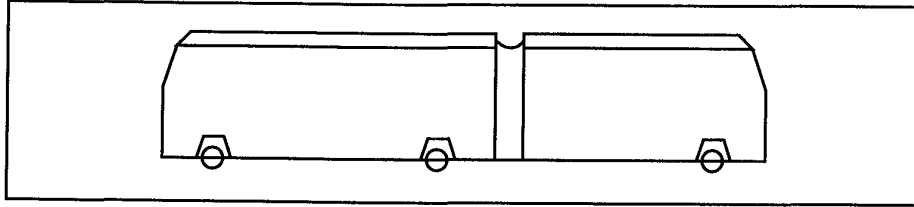
Doors: Two Double, One Single

Articulation: Floating

Body Material: Steel

Buff Load: N/A

Concept Schematic



RUNNING GEAR

Axle Arrangement: A'A'1'

Power Wheel Diameter: 560 mm (22 in)

Power Gear: Motored EEF self-steering wheelset

Trailer Wheel Diameter: 560 mm (22 in)

Trailer Gear: EEF wheelset

Track Gauge: 1435 mm (56.5 in)

Min Curve Radius: 18 m (59.1 ft)

Max Speed: 70 km/h (44 mph)

PROPULSION

Propulsion Technology: AC

Line Voltage: 750 V

Number of Motors: 4

Total Power: 240 kW (322 hp)

Specific Power: 13.5 kW/tonne (16.5 hp/ton)

BRAKES

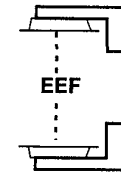
N/A

PRICE DATA

Cost Density: N/A

Vehicle Cost: N/A

Powered Running Gear



Trailing Running Gear



City/Authority: Frankfurt am Main
(Germany)

Manufacturers: Duewag
Siemens

Vehicle Type: R3.1

Category: 3

Ordered: 20

Year of Delivery: 1993

CHARACTERISTICS

Car Length: 27.2 m (89.2 ft)

Car Width: 2.35 m (7.7 ft)

Low Floor Area: 100%

Floor Height

High: 350 mm (13.8 in)

Low: 300 mm (11.8 in)

Weight: 33 tonnes (72,800 lbs)

Specific Weight: 516 kg/m² (106 lb/ft²)

Seats: 61

Standees: 109 @ 4 pass/m²

CONSTRUCTION

Travel Direction: Bidirectional

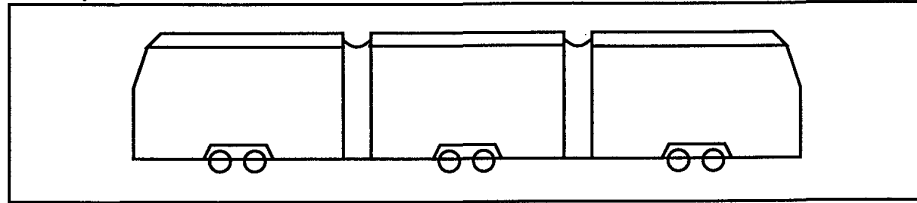
Doors: Four Double

Articulation: Floating

Body Material: Steel

Buff Load: N/A

Concept Schematic



RUNNING GEAR

Axle Arrangement: Bo'2'Bo'

Power Wheel Diameter: 740 mm (29.1 in)

Power Gear: Four hub motor-driven, independent wheels

Trailer Wheel Diameter: 590 mm (23.2 in)

Trailer Gear: Four independent wheel trailer truck

Track Gauge: 1435 mm (56.5 in)

Min Curve Radius: 18 m (59.1 ft)

Max Speed: 70 km/h (44 mph)

PROPULSION

Propulsion Technology: AC

Line Voltage: 600 V

Number of Motors: 8

Total Power: 400 kW (536 hp)

Specific Power: 12.1 kW/tonne (14.7 hp/ton)

BRAKES

1. Combined Regenerative/Rheostatic
2. Hydraulic Disc Brakes
3. Electromagnetic Track Brakes

PRICE DATA

Cost Density: \$60,000 \$DM/m²

Vehicle Cost: N/A

Powered Running Gear



Trailing Running Gear



City/Authority: Frankfurt-an-der-Oder (Germany)

Manufacturers: AEG (MAN)
AEG/Kiepe

Vehicle Type: GT6N

Category: 3

Ordered: 13

Year of Delivery: N/A

CHARACTERISTICS

Car Length: 26.5 m (86.9 ft)

Car Width: 2.3 m (7.5 ft)

Low Floor Area: 100%

Floor Height

High: 350 mm (13.8 in)

Low: 300 mm (11.8 in)

Weight: 26.8 tonnes (59,100 lbs)

Specific Weight: 440 kg/m2 (91 lb/ft2)

Seats: 60

Standees: 103 @ 4 pass/m2

CONSTRUCTION

Travel Direction: Unidirectional

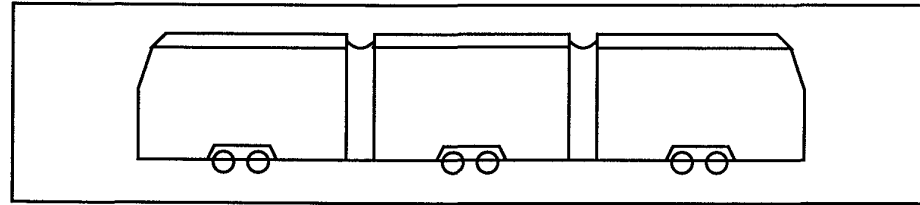
Doors: Four Double

Articulation: Floating

Body Material: Stainless Steel

Buff Load: 20 tonnes (44,100 lbs)

Concept Schematic



RUNNING GEAR

Axle Arrangement: 1A'A1'A1'

Power Wheel Diameter: 680 mm (26.8 in)

Power Gear: Independent wheels, one pair driven, one pair free-wheeling

Trailer Wheel Diameter: N/A

Trailer Gear: N/A

Track Gauge: 1435 mm (56.5 in)

Min Curve Radius: 15 m (49.2 ft)

Max Speed: 70 km/h (44 mph)

PROPULSION

Propulsion Technology: AC

Line Voltage: 600 V

Number of Motors: 3

Total Power: 252 kW (338 hp)

Specific Power: 9.4 kW/tonne (11.4 hp/ton)

BRAKES

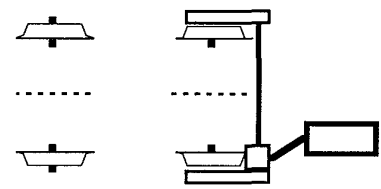
- 1. Regenerative
- 2. Spring Loaded Disc

PRICE DATA

Cost Density: N/A

Vehicle Cost: N/A

Powered Running Gear



Trailing Running Gear

City/Authority: Halle
(Germany)

Manufacturers: AEG (MAN)
AEG/Kiepe

Vehicle Type: GT6N

Category: 3

Ordered: 1

Year of Delivery: N/A

CHARACTERISTICS

Car Length: 26.5 m (86.9 ft)

Car Width: 2.3 m (7.5 ft)

Low Floor Area: 100%

Floor Height

High: 350 mm (13.8 in)

Low: 300 mm (11.8 in)

Weight: 26.8 tonnes (59,100 lbs)

Specific Weight: 440 kg/m² (91 lb/ft²)

Seats: 60

Standees: 103 @ 4 pass/m²

CONSTRUCTION

Travel Direction: Unidirectional

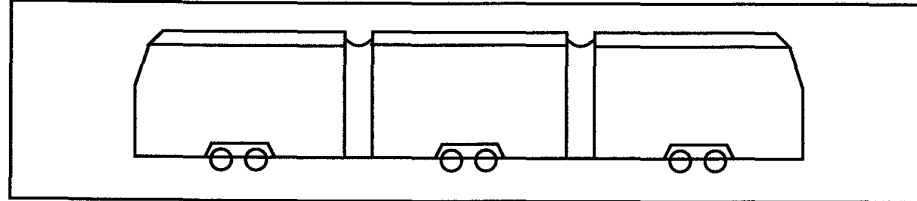
Doors: Four Double

Articulation: Floating

Body Material: Stainless Steel

Buff Load: 20 tonnes (44,100 lbs)

Concept Schematic



RUNNING GEAR

Axle Arrangement: 1A'A1'A1'

Power Wheel Diameter: 680 mm (26.8 in)

Power Gear: Independent wheels, one pair driven,
one pair free-wheeling

Trailer Wheel Diameter: N/A

Trailer Gear: N/A

Track Gauge: 1435 mm (56.5 in)

Min Curve Radius: 15 m (49.2 ft)

Max Speed: 70 km/h (44 mph)

PROPULSION

Propulsion Technology: AC

Line Voltage: 600 V

Number of Motors: 3

Total Power: 252 kW (338 hp)

Specific Power: 9.4 kW/tonne (11.4 hp/ton)

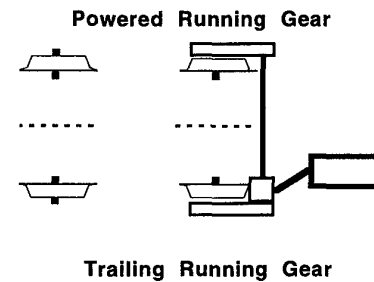
BRAKES

1. Regenerative
2. Spring Loaded Disc

PRICE DATA

Cost Density: N/A

Vehicle Cost: N/A



City/Authority: Jena
(Germany)

Manufacturers: AEG (MAN)
AEG/Kiepe

Vehicle Type: GT8N

Category: 3

Ordered: 10

Year of Delivery: N/A

CHARACTERISTICS

Car Length: 35 m (114.8 ft)

Car Width: 2.3 m (7.5 ft)

Low Floor Area: 100%

Floor Height

High: 350 mm (13.8 in)

Low: 300 mm (11.8 in)

Weight: 34 tonnes (75,000 lbs)

Specific Weight: 422 kg/m² (87 lb/ft²)

Seats: 89

Standees: 137 @ 4 pass/m²

CONSTRUCTION

Travel Direction: Bidirectional

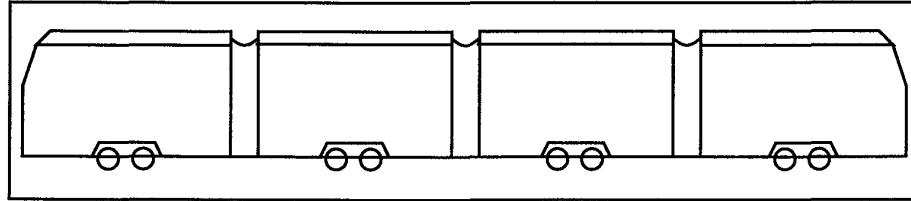
Doors: Five Double

Articulation: Floating

Body Material: Steel

Buff Load: N/A

Concept Schematic



RUNNING GEAR

Axle Arrangement: 1A'1A'1A'1A'

Power Wheel Diameter: 680 mm (26.8 in)

Power Gear: Independent wheels, one pair driven,
one pair free-wheeling

Trailer Wheel Diameter: 680 mm (26.8 in)

Trailer Gear: N/A

Track Gauge: 1435 mm (56.5 in)

Min Curve Radius: 15 m (49.2 ft)

Max Speed: 70 km/h (44 mph)

PROPULSION

Propulsion Technology: AC

Line Voltage: 600 V

Number of Motors: 4

Total Power: 376 kW (504 hp)

Specific Power: 11.1 kW/tonne (13.4 hp/ton)

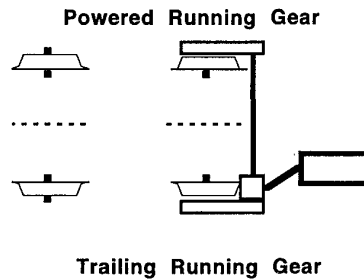
BRAKES

N/A

PRICE DATA

Cost Density: N/A

Vehicle Cost: N/A



City/Authority: Lille
(France)

Manufacturers: Breda
AEG-Westinghouse

Vehicle Type: VLC

Category: 3

Ordered: 24

Year of Delivery: 1993

CHARACTERISTICS

Car Length: 29.9 m (98.1 ft)

Car Width: 2.4 m (7.9 ft)

Low Floor Area: 80%

Floor Height

High: 950 mm (37.4 in)

Low: 350 mm (13.8 in)

Weight: 40 tonnes (88,200 lbs)

Specific Weight: 557 kg/m² (114 lb/ft²)

Seats: 50

Standees: 118 @ 4 pass/m²

CONSTRUCTION

Travel Direction: Bidirectional

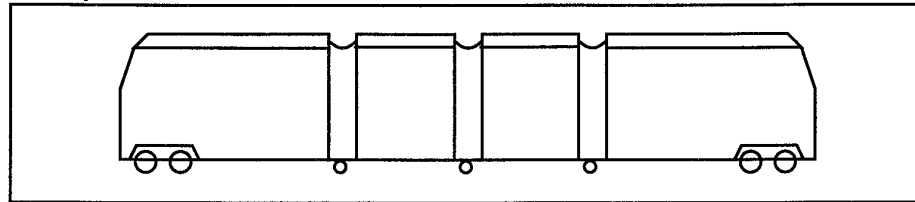
Doors: Four Double

Articulation: Supported

Body Material: Aluminum bolted onto a steel chassis

Buff Load: 50 tonnes (110,250 lbs)

Concept Schematic



RUNNING GEAR

Axle Arrangement: B'1 1 1 B'

Power Wheel Diameter: 680 mm (26.8 in)

Power Gear: Transverse-mounted motor drives both axles through parallel gears and cardan shaft

Trailer Wheel Diameter: 550 mm (21.7 in)

Trailer Gear: Single wheelset with small independent wheels built into articulation

Track Gauge: 1000 mm (39.4 in)

Min Curve Radius: 25 m (82 ft)

Max Speed: 70 km/h (44 mph)

PROPULSION

Propulsion Technology: AC

Line Voltage: 600 V

Number of Motors: 2

Total Power: 410 kW (550 hp)

Specific Power: 10.3 kW/tonne (12.5 hp/ton)

BRAKES

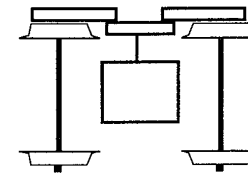
1. Regenerative
2. Electromagnetic Rail
3. Disc Brakes

PRICE DATA

Cost Density: \$42,700 \$DM/m²

Vehicle Cost: N/A

Powered Running Gear



Trailing Running Gear





City/Authority: Mannheim/ MVG
(Germany)

Manufacturers: German Consortium (VDV)

Vehicle Type: dGTW-ER

Category: 3

Ordered: 1

Year of Delivery: 1991

CHARACTERISTICS

Car Length: 26.69 m (87.6 ft)

Car Width: 2.3 m (7.5 ft)

Low Floor Area: 100%

Floor Height

High: 350 mm (13.8 in)

Low: 290 mm (11.4 in)

Weight: 23.98 tonnes (52,900 lbs)

Specific Weight: 391 kg/m² (80 lb/ft²)

Seats: 74

Standees: 79 @ 4 pass/m²

CONSTRUCTION

Travel Direction: Unidirectional

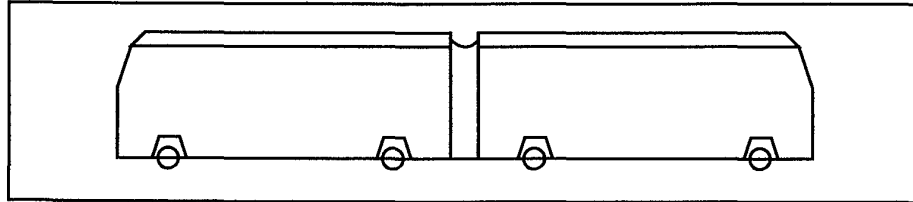
Doors: Three Double, One Single

Articulation: Floating

Body Material: Steel

Buff Load: N/A

Concept Schematic



RUNNING GEAR

Axle Arrangement: A'A'A'1'

Power Wheel Diameter: 560 mm (22 in)

Power Gear: Motored EEF self-steering wheelset

Trailer Wheel Diameter: 560 mm (22 in)

Trailer Gear: EEF wheelset

Track Gauge: 1000 mm (39.4 in)

Min Curve Radius: 15 m (49.2 ft)

Max Speed: 70 km/h (44 mph)

PROPULSION

Propulsion Technology: AC

Line Voltage: 750 V

Number of Motors: 4

Total Power: 240 kW (322 hp)

Specific Power: 10.0 kW/tonne (12.2 hp/ton)

BRAKES

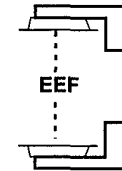
N/A

PRICE DATA

Cost Density: N/A

Vehicle Cost: N/A

Powered Running Gear



Trailing Running Gear



City/Authority: Munich
(Germany)

Manufacturers: AEG (MAN)
Siemens
AEG-Westinghouse

Vehicle Type: GT6N/ R1.1

Category: 3

Ordered: 3

Year of Delivery: 1990

CHARACTERISTICS

Car Length: 26.5 m (86.9 ft)

Car Width: 2.3 m (7.5 ft)

Low Floor Area: 100%

Floor Height

High: 350 mm (13.8 in)

Low: 300 mm (11.8 in)

Weight: 29.5 tonnes (65,000 lbs)

Specific Weight: 484 kg/m² (100 lb/ft²)

Seats: 60

Standees: 103 @ 4 pass/m²

CONSTRUCTION

Travel Direction: Unidirectional

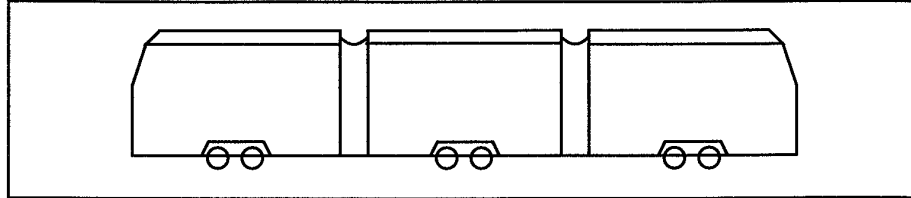
Doors: Four Double

Articulation: Floating

Body Material: Stainless Steel

Buff Load: 20 tonnes (44,100 lbs)

Concept Schematic



RUNNING GEAR

Axle Arrangement: 1A'A1'A1'

Power Wheel Diameter: 680 mm (26.8 in)

Power Gear: Independent wheels, one pair driven,
one pair free-wheeling

Trailer Wheel Diameter: N/A

Trailer Gear: N/A

Track Gauge: 1435 mm (56.5 in)

Min Curve Radius: 15 m (49.2 ft)

Max Speed: 70 km/h (44 mph)

PROPULSION

Propulsion Technology: AC

Line Voltage: 600 V

Number of Motors: 3

Total Power: 252 kW (338 hp)

Specific Power: 8.5 kW/tonne (10.4 hp/ton)

BRAKES

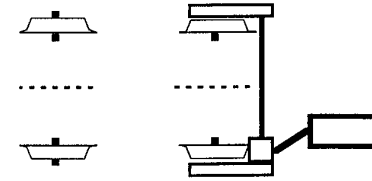
1. Regenerative
2. Spring Loaded Disc

PRICE DATA

Cost Density: N/A

Vehicle Cost: N/A

Powered Running Gear



Trailing Running Gear

City/Authority: Munich
(Germany)

Manufacturers: AEG (MAN)
Siemens
AEG Westinghouse

Vehicle Type: GT6N

Category: 3

Ordered: 70

Year of Delivery: 1994

CHARACTERISTICS

Car Length: 27.3 m (89.6 ft)

Car Width: 2.3 m (7.5 ft)

Low Floor Area: 100%

Floor Height

High: 350 mm (13.8 in)

Low: 300 mm (11.8 in)

Weight: 29.4 tonnes (64,800 lbs)

Specific Weight: 468 kg/m² (96 lb/ft²)

Seats: 61

Standees: 110 @ 4 pass/m²

CONSTRUCTION

Travel Direction: Bidirectional

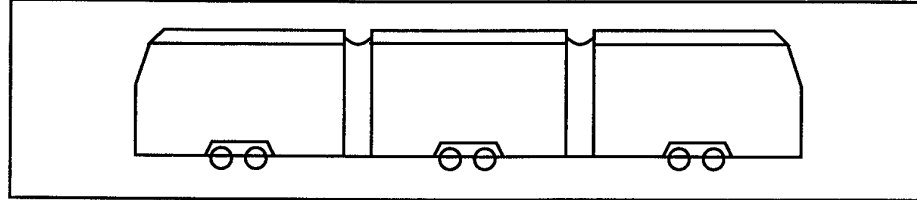
Doors: Four Double

Articulation: Floating

Body Material: Stainless Steel

Buff Load: 20 tonnes (44,100 lbs)

Concept Schematic



RUNNING GEAR

Axle Arrangement: 1A'A1'A1'

Power Wheel Diameter: 680 mm (26.8 in)

Power Gear: Independent wheels, one pair driven,
one pair free-wheeling

Trailer Wheel Diameter: N/A

Trailer Gear: N/A

Track Gauge: 1435 mm (56.5 in)

Min Curve Radius: 15 m (49.2 ft)

Max Speed: 70 km/h (44 mph)

PROPULSION

Propulsion Technology: AC

Line Voltage: 600 V

Number of Motors: 3

Total Power: 255 kW (342 hp)

Specific Power: 8.7 kW/tonne (10.6 hp/ton)

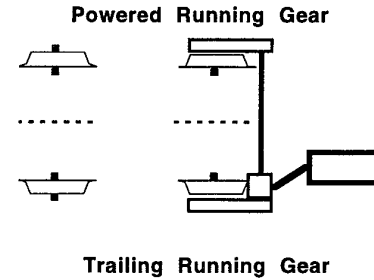
BRAKES

1. Regenerative
2. Spring Loaded Disc

PRICE DATA

Cost Density: N/A

Vehicle Cost: \$DM3,420,000



City/Authority: Prototype

Manufacturers: Bombardier (BN)
Holec

Vehicle Type: LRV2000

Category: 3

Ordered: 1

Year of Delivery: 1990

CHARACTERISTICS

Car Length: 20.2 m (66.3 ft)

Car Width: 2.47 m (8.1 ft)

Low Floor Area: 100%

Floor Height

High: 350 mm (13.8 in)

Low: 350 mm (13.8 in)

Weight: 24 tonnes (52,900 lbs)

Specific Weight: 481 kg/m² (99 lb/ft²)

Seats: 44

Standees: 98 @ 4 pass/m²

CONSTRUCTION

Travel Direction: Unidirectional

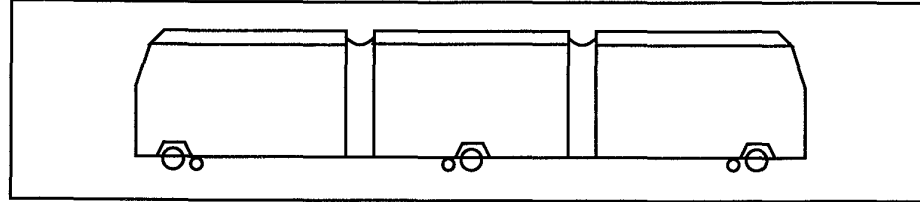
Doors: N/A

Articulation: N/A

Body Material: N/A

Buff Load: N/A

Concept Schematic



RUNNING GEAR

Axle Arrangement: A'1'1'A'1'A'

Power Wheel Diameter: 675 mm (26.6 in)

Power Gear: Articulated truck frame, two large hub motor-driven wheels, two small guiding wheels

Trailer Wheel Diameter: 375 mm (14.8 in)

Trailer Gear: N/A

Track Gauge: 1435 mm (56.5 in)

Min Curve Radius: N/A

Max Speed: 70 km/h (44 mph)

PROPULSION

Propulsion Technology: AC

Line Voltage: 600 V

Number of Motors: 6

Total Power: 228 kW (306 hp)

Specific Power: 9.5 kW/tonne (11.6 hp/ton)

BRAKES

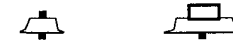
N/A

PRICE DATA

Cost Density: N/A

Vehicle Cost: N/A

Powered Running Gear



Trailing Running Gear

City/Authority: Prototype

Manufacturers: Schindler (SIG)
SIG
ABB

Vehicle Type: Cobra 370

Category: 3

Ordered: 1

Year of Delivery: 1993

CHARACTERISTICS

Car Length: 24.5 m (80.4 ft)

Car Width: 2.3 m (7.5 ft)

Low Floor Area: 100%

Floor Height

High: 370 mm (14.6 in)

Low: 320 mm (12.6 in)

Weight: 25 tonnes (55,100 lbs)

Specific Weight: 444 kg/m² (91 lb/ft²)

Seats: 59

Standees: 87 @ 4 pass/m²

CONSTRUCTION

Travel Direction: Unidirectional

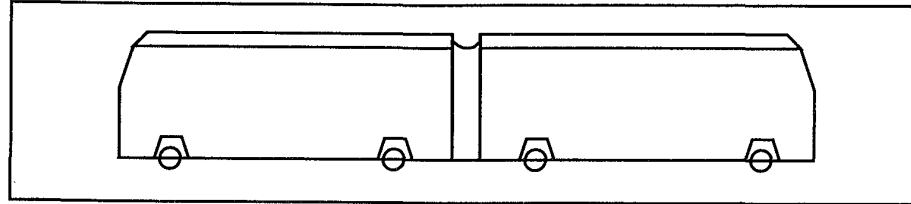
Doors: Four Double

Articulation: Floating

Body Material: Steel Bottom w/Aluminum

Buff Load: N/A

Concept Schematic



RUNNING GEAR

Axle Arrangement: 'A'A'A'A'

Power Wheel Diameter: 560 mm (22 in)

Power Gear: Motor drives wheels on one side via cardan shafts

Trailer Wheel Diameter: 560 mm (22 in)

Trailer Gear: N/A

Track Gauge: 1000 mm (39.4 in)

Min Curve Radius: 11.8 m (38.7 ft)

Max Speed: 65 km/h (40 mph)

PROPULSION

Propulsion Technology: AC

Line Voltage: 600 V

Number of Motors: 4

Total Power: 280 kW (375 hp)

Specific Power: 11.2 kW/tonne (13.6 hp/ton)

BRAKES

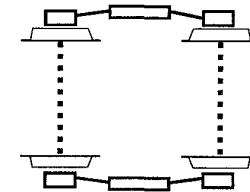
N/A

PRICE DATA

Cost Density: N/A

Vehicle Cost: N/A

Powered Running Gear



Trailing Running Gear

City/Authority: Prototype (Milan)
(Italy)

Manufacturers: Socimi

Vehicle Type: S-350LRV

Category: 3

Ordered: 1

Year of Delivery: 1989

CHARACTERISTICS

Car Length: 14 m (45.9 ft)

Car Width: 2.4 m (7.9 ft)

Low Floor Area: 100%

Floor Height

High: 350 mm (13.8 in)

Low: 350 mm (13.8 in)

Weight: 10.5 tonnes (23,100 lbs)

Specific Weight: 312 kg/m² (64 lb/ft²)

Seats: 33

Standees: 49 @ 4 pass/m²

CONSTRUCTION

Travel Direction: Unidirectional

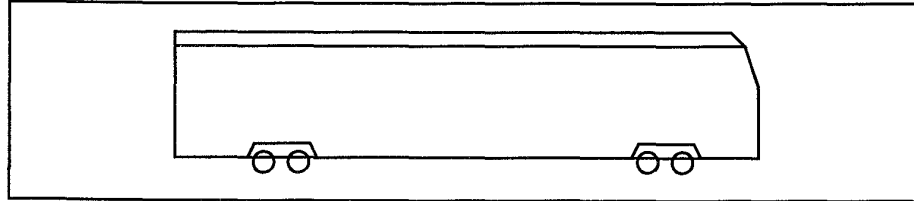
Doors: Three Double, One Single

Articulation: N/A

Body Material: N/A

Buff Load: N/A

Concept Schematic



RUNNING GEAR

Axle Arrangement: Bo'Bo'

Power Wheel Diameter: 550 mm (21.7 in)

Power Gear: Independent wheels mounted on radial-arm axleboxes driven by motor via parallel gears

Trailer Wheel Diameter: N/A

Trailer Gear: N/A

Track Gauge: 1445 mm (56.9 in)

Min Curve Radius: 15 m (49.2 ft)

Max Speed: 70 km/h (44 mph)

PROPULSION

Propulsion Technology: DC

Line Voltage: 600 V

Number of Motors: 8

Total Power: 160 kW (215 hp)

Specific Power: 15.2 kW/tonne (18.6 hp/ton)

BRAKES

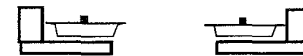
N/A

PRICE DATA

Cost Density: N/A

Vehicle Cost: N/A

Powered Running Gear



Trailing Running Gear

City/Authority: Prototype (Rome)
(Italy)

Manufacturers: Breda
AEG-Westinghouse

Vehicle Type: VLC

Category: 3

Ordered: 1

Year of Delivery: 1990

CHARACTERISTICS

Car Length: 22 m (72.2 ft)

Car Width: 2.5 m (8.2 ft)

Low Floor Area: 75%

Floor Height

High: 950 mm (37.4 in)

Low: 350 mm (13.8 in)

Weight: 22 tonnes (48,500 lbs)

Specific Weight: 400 kg/m² (82 lb/ft²)

Seats: 36

Standees: 94 @ 4 pass/m²

CONSTRUCTION

Travel Direction: Bidirectional

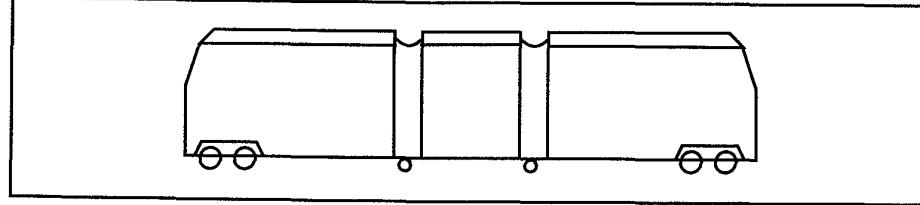
Doors: Three Double

Articulation: Supported

Body Material: Aluminum bolted onto a steel chassis

Buff Load: N/A

Concept Schematic



RUNNING GEAR

Axle Arrangement: B'1 1 B'

Power Wheel Diameter: 680 mm (26.8 in)

Power Gear: Transverse-mounted motor drives both axles through parallel gears and cardan shaft

Trailer Wheel Diameter: 500 mm (19.7 in)

Trailer Gear: Single wheelset with small independent wheels built into articulation

Track Gauge: 1445 mm (56.9 in)

Min Curve Radius: 20 m (65.6 ft)

Max Speed: 70 km/h (44 mph)

PROPULSION

Propulsion Technology: AC

Line Voltage: 600 V

Number of Motors: 2

Total Power: 410 kW (550 hp)

Specific Power: 18.6 kW/tonne (22.7 hp/ton)

BRAKES

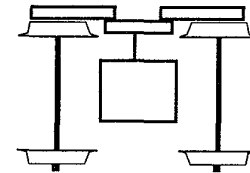
1. Regenerative
2. Electromagnetic Rail
3. Disc Brakes

PRICE DATA

Cost Density: N/A

Vehicle Cost: N/A

Powered Running Gear



Trailing Running Gear



.....



City/Authority: Prototype (Rome)
(Italy)

Manufacturers: Socimi
ABB

Vehicle Type: N/A

Category: 3

Ordered: 1

Year of Delivery: 1992

CHARACTERISTICS

Car Length: 22 m (72.2 ft)

Car Width: 2.4 m (7.9 ft)

Low Floor Area: 100%

Floor Height

High: 350 mm (13.8 in)

Low: 350 mm (13.8 in)

Weight: 25 tonnes (55,100 lbs)

Specific Weight: 473 kg/m² (97 lb/ft²)

Seats: 36

Standees: 91 @ 4 pass/m²

CONSTRUCTION

Travel Direction: Bidirectional

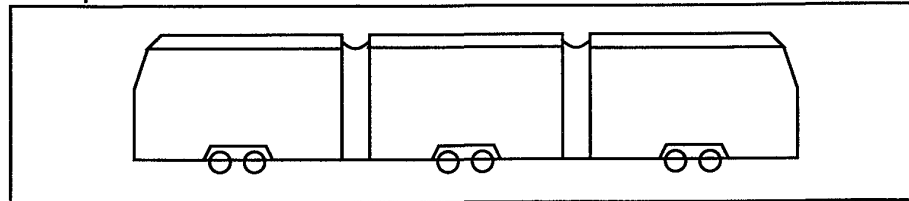
Doors: N/A

Articulation: N/A

Body Material: Welded Aluminum w/ Reinforced Plastic

Buff Load: N/A

Concept Schematic



RUNNING GEAR

Axle Arrangement: BoBoBo

Power Wheel Diameter: 550 mm (21.7 in)

Power Gear: Independent wheels mounted on radial-arm axleboxes driven by motor via parallel gears

Trailer Wheel Diameter: N/A

Trailer Gear: N/A

Track Gauge: 1445 mm (56.9 in)

Min Curve Radius: N/A

Max Speed: 60 km/h (37 mph)

PROPULSION

Propulsion Technology: AC

Line Voltage: 600 V

Number of Motors: 12

Total Power: 294 kW (394 hp)

Specific Power: 11.8 kW/tonne (14.3 hp/ton)

BRAKES

1. Regenerative
2. Hydraulic Disc Brakes
3. Electromagnetic Rail Brakes

PRICE DATA

Cost Density: N/A

Vehicle Cost: N/A

Powered Running Gear



Trailing Running Gear

City/Authority: Prototype (Turin)
(Italy)

Manufacturers: Firema

Vehicle Type: Prototype

Category: 3

Ordered: 1

Year of Delivery: N/A

CHARACTERISTICS

Car Length: 22.2 m (72.8 ft)

Car Width: 2.3 m (7.5 ft)

Low Floor Area: 100%

Floor Height

High: 350 mm (13.8 in)

Low: 350 mm (13.8 in)

Weight: 24 tonnes (52,900 lbs)

Specific Weight: 470 kg/m² (97 lb/ft²)

Seats: 55

Standeers: 88 @ 4 pass/m²

CONSTRUCTION

Travel Direction: N/A

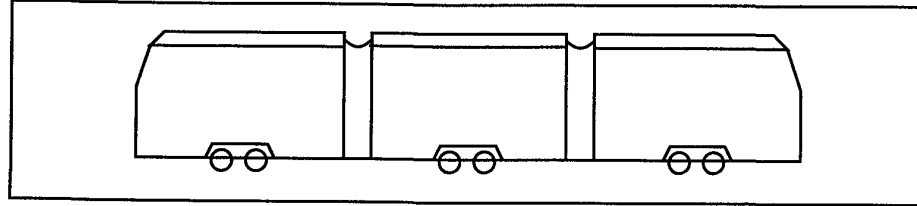
Doors: N/A

Articulation: N/A

Body Material: N/A

Buff Load: N/A

Concept Schematic



RUNNING GEAR

Axle Arrangement: Bo'2'Bo'

Power Wheel Diameter: 680 mm (26.8 in)

Power Gear: Unknown

Trailer Wheel Diameter: 680 mm (26.8 in)

Trailer Gear: Four independent wheel trailer truck

Track Gauge: 1445 mm (56.9 in)

Min Curve Radius: N/A

Max Speed: 90 km/h (56 mph)

PROPULSION

Propulsion Technology: DC

Line Voltage: 600 V

Number of Motors: 8

Total Power: 480 kW (644 hp)

Specific Power: 20.0 kW/tonne (24.3 hp/ton)

BRAKES

N/A

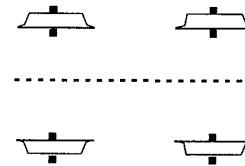
PRICE DATA

Cost Density: N/A

Vehicle Cost: N/A

Powered Running Gear

Trailing Running Gear



City/Authority: Strasbourg
(France)

Manufacturers: ABB (Socimi)

Vehicle Type: Eurotram

Category: 3

Ordered: 26

Year of Delivery: 1994

CHARACTERISTICS

Car Length: 32.5 m (106.6 ft)

Car Width: 2.4 m (7.9 ft)

Low Floor Area: 100%

Floor Height

High: 350 mm (13.8 in)

Low: 350 mm (13.8 in)

Weight: 29 tonnes (63,900 lbs)

Specific Weight: 372 kg/m² (76 lb/ft²)

Seats: 49

Standees: 164 @ 4 pass/m²

CONSTRUCTION

Travel Direction: Bidirectional

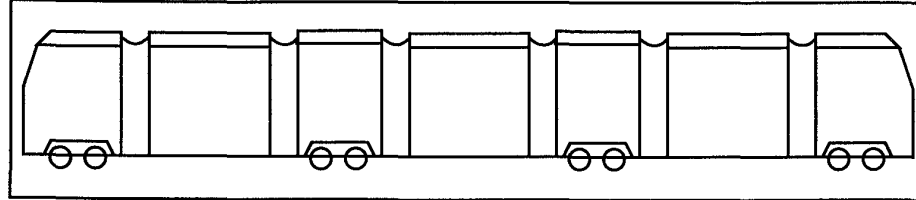
Doors: Six Double

Articulation: Floating

Body Material: Welded Aluminum w/ Reinforced Plastic

Buff Load: N/A

Concept Schematic



RUNNING GEAR

Axle Arrangement: BoBoBo2

Power Wheel Diameter: 550 mm (21.7 in)

Power Gear: Independent wheels mounted on radial-arm axleboxes driven by motor via parallel gears

Trailer Wheel Diameter: 550 mm (21.7 in)

Trailer Gear: Four independent wheel trailer truck

Track Gauge: 1435 mm (56.5 in)

Min Curve Radius: 25 m (82 ft)

Max Speed: 60 km/h (37 mph)

PROPULSION

Propulsion Technology: AC

Line Voltage: 750 V

Number of Motors: 12

Total Power: 408 kW (547 hp)

Specific Power: 14.1 kW/tonne (17.1 hp/ton)

BRAKES

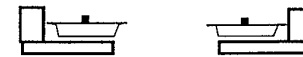
1. Regenerative
2. Hydraulic Disc Brakes
3. Electromagnetic Rail Brakes

PRICE DATA

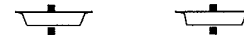
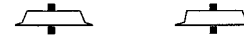
Cost Density: \$58,000 \$DM/m²

Vehicle Cost: N/A

Powered Running Gear



Trailing Running Gear



City/Authority: Vienna "A"
(Austria)

Manufacturers: SGP
Elin

Vehicle Type: ULF197-4

Category: 3

Ordered: 100

Year of Delivery: 1995

CHARACTERISTICS

Car Length: 23.61 m (77.5 ft)

Car Width: 2.4 m (7.9 ft)

Low Floor Area: 100%

Floor Height

High: 197 mm (7.8 in)

Low: 197 mm (7.8 in)

Weight: 23 tonnes (50,700 lbs)

Specific Weight: 406 kg/m² (83 lb/ft²)

Seats: 51

Standeers: 100 @ 4 pass/m²

CONSTRUCTION

Travel Direction: Unidirectional

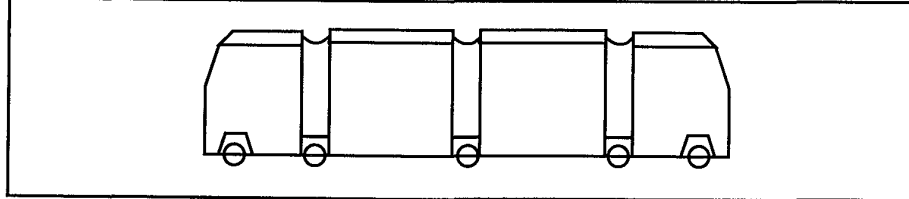
Doors: Four Double @ 152 mm (6")

Articulation: Supported

Body Material: N/A

Buff Load: 20 tonnes (44,100 lbs)

Concept Schematic



RUNNING GEAR

Axle Arrangement: 1A'A'A'1

Power Wheel Diameter: 670 mm (26.4 in)

Power Gear: Vertically mounted motors driving independent wheels built into articulation portal

Trailer Wheel Diameter: 670 mm (26.4 in)

Trailer Gear: Single wheelset steered by the articulation

Track Gauge: 1435 mm (56.5 in)

Min Curve Radius: 18 m (59.1 ft)

Max Speed: 70 km/h (44 mph)

PROPULSION

Propulsion Technology: AC

Line Voltage: 600 V

Number of Motors: 6

Total Power: 360 kW (483 hp)

Specific Power: 15.7 kW/tonne (19.1 hp/ton)

BRAKES

- 1. Dynamic
- 2. Electro-Hydraulic
- 3. Track Brakes

PRICE DATA

Cost Density: N/A

Vehicle Cost: N/A

Powered Running Gear



Trailing Running Gear



City/Authority: Vienna "A" Prototype
(Austria)

Manufacturers: SGP
Elin

Vehicle Type: ULF197-4

Category: 3

Ordered: 1

Year of Delivery: 1994

CHARACTERISTICS

Car Length: 23.61 m (77.5 ft)

Car Width: 2.4 m (7.9 ft)

Low Floor Area: 100%

Floor Height

High: 197 mm (7.8 in)

Low: 197 mm (7.8 in)

Weight: 23 tonnes (50,700 lbs)

Specific Weight: 406 kg/m² (83 lb/ft²)

Seats: 51

Standees: 100 @ 4 pass/m²

CONSTRUCTION

Travel Direction: Unidirectional

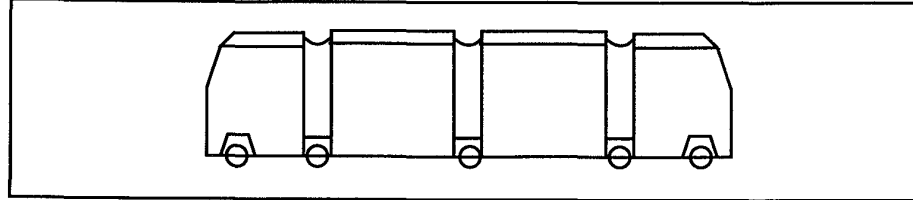
Doors: Four Double @ 152 mm (6")

Articulation: Supported

Body Material: N/A

Buff Load: 20 tonnes (44,100 lbs)

Concept Schematic



RUNNING GEAR

Axle Arrangement: 1'A'A'A'1

Power Wheel Diameter: 670 mm (26.4 in)

Power Gear: Vertically mounted motors driving independent wheels built into articulation portal

Trailer Wheel Diameter: 670 mm (26.4 in)

Trailer Gear: Single wheelset steered by the articulation

Track Gauge: 1435 mm (56.5 in)

Min Curve Radius: 18 m (59.1 ft)

Max Speed: 70 km/h (44 mph)

PROPULSION

Propulsion Technology: AC

Line Voltage: 600 V

Number of Motors: 6

Total Power: 360 kW (483 hp)

Specific Power: 15.7 kW/tonne (19.1 hp/ton)

BRAKES

1. Dynamic
2. Electro-Hydraulic
3. Track Brakes

PRICE DATA

Cost Density: N/A

Vehicle Cost: N/A

Powered Running Gear



Trailing Running Gear



City/Authority: Vienna "B"
(Austria)

Manufacturers: SGP
Elin

Vehicle Type: ULF197-6

Category: 3

Ordered: 50

Year of Delivery: 1995

CHARACTERISTICS

Car Length: 34.87 m (114.4 ft)

Car Width: 2.4 m (7.9 ft)

Low Floor Area: 100%

Floor Height

High: 197 mm (7.8 in)

Low: 197 mm (7.8 in)

Weight: 32.5 tonnes (71,600 lbs)

Specific Weight: 388 kg/m² (79 lb/ft²)

Seats: 79

Standees: 152 @ 4 pass/m²

CONSTRUCTION

Travel Direction: Unidirectional

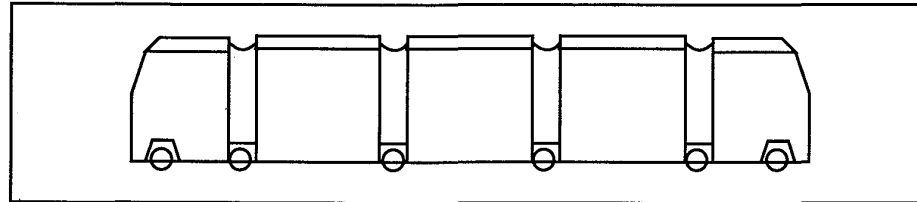
Doors: Seven Double @ 152 mm (6")

Articulation: Supported

Body Material: N/A

Buff Load: 20 tonnes (44,100 lbs)

Concept Schematic



RUNNING GEAR

Axle Arrangement: 1'A'A'A'A'1'

Power Wheel Diameter: 670 mm (26.4 in)

Power Gear: Vertically mounted motors driving independent wheels built into articulation portal

Trailer Wheel Diameter: 670 mm (26.4 in)

Trailer Gear: Single wheelset steered by the articulation

Track Gauge: 1435 mm (56.5 in)

Min Curve Radius: 18 m (59.1 ft)

Max Speed: 70 km/h (44 mph)

PROPULSION

Propulsion Technology: AC

Line Voltage: 600 V

Number of Motors: 8

Total Power: 480 kW (644 hp)

Specific Power: 14.8 kW/tonne (18 hp/ton)

BRAKES

1. Dynamic
2. Electro-Hydraulic
3. Track Brakes

PRICE DATA

Cost Density: N/A

Vehicle Cost: N/A

Powered Running Gear



Trailing Running Gear



City/Authority: Vienna "B" Prototype
(Austria)

Manufacturers: SGP
Elin

Vehicle Type: ULF197-6

Category: 3

Ordered: 1

Year of Delivery: 1994

CHARACTERISTICS

Car Length: 34.87 m (114.4 ft)

Car Width: 2.4 m (7.9 ft)

Low Floor Area: 100%

Floor Height

High: 197 mm (7.8 in)

Low: 197 mm (7.8 in)

Weight: 32.5 tonnes (71,600 lbs)

Specific Weight: 388 kg/m² (79 lb/ft²)

Seats: 79

Standees: 152 @ 4 pass/m²

CONSTRUCTION

Travel Direction: Unidirectional

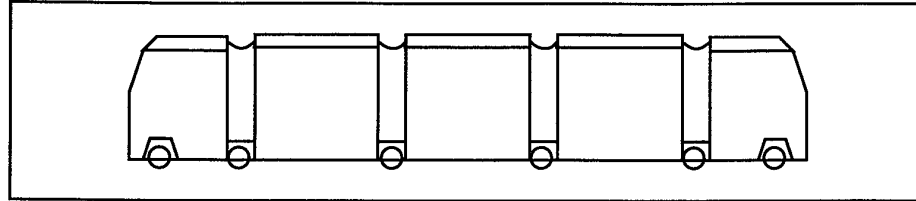
Doors: Seven Double @ 152 mm (6")

Articulation: Supported

Body Material: N/A

Buff Load: 20 tonnes (44,100 lbs)

Concept Schematic



RUNNING GEAR

Axle Arrangement: 1'A'A'A'A'1

Power Wheel Diameter: 670 mm (26.4 in)

Power Gear: Vertically mounted motors driving independent wheels built into articulation portal

Trailer Wheel Diameter: 670 mm (26.4 in)

Trailer Gear: Single wheelset steered by the articulation

Track Gauge: 1435 mm (56.5 in)

Min Curve Radius: 18 m (59.1 ft)

Max Speed: 70 km/h (44 mph)

PROPULSION

Propulsion Technology: AC

Line Voltage: 600 V

Number of Motors: 8

Total Power: 480 kW (644 hp)

Specific Power: 14.8 kW/tonne (18 hp/ton)

BRAKES

1. Dynamic
2. Electro-Hydraulic
3. Track Brakes

PRICE DATA

Cost Density: N/A

Vehicle Cost: N/A

Powered Running Gear



Trailing Running Gear



City/Authority: Wurzburg
(Germany)

Manufacturers: LHB
Siemens

Vehicle Type: GTW

Category: 3

Ordered: 20

Year of Delivery: N/A

CHARACTERISTICS

Car Length: 29.1 m (95.5 ft)

Car Width: 2.4 m (7.9 ft)

Low Floor Area: 100%

Floor Height

High: 350 mm (13.8 in)

Low: 300 mm (11.8 in)

Weight: 35 tonnes (77,200 lbs)

Specific Weight: 501 kg/m² (102 lb/ft²)

Seats: 80

Standees: 100 @ 4 pass/m²

CONSTRUCTION

Travel Direction: N/A

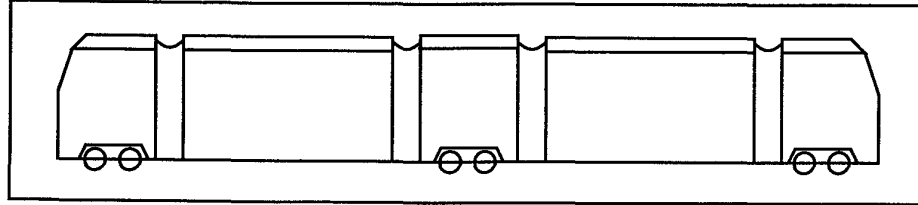
Doors: N/A

Articulation: Floating

Body Material: N/A

Buff Load: 20 tonnes (44,100 lbs)

Concept Schematic



RUNNING GEAR

Axle Arrangement: Bo'Bo'Bo'

Power Wheel Diameter: 690 mm (27.2 in)

Power Gear: Four hub motor-driven, independent wheels

Trailer Wheel Diameter: N/A

Trailer Gear: N/A

Track Gauge: 1000 mm (39.4 in)

Min Curve Radius: N/A

Max Speed: 80 km/h (50 mph)

PROPULSION

Propulsion Technology: AC

Line Voltage: 600 V

Number of Motors: 12

Total Power: 600 kW (805 hp)

Specific Power: 17.1 kW/tonne (20.9 hp/ton)

BRAKES

N/A

PRICE DATA

Cost Density: N/A

Vehicle Cost: N/A

Powered Running Gear



Trailing Running Gear

City/Authority: Zwickau
(Germany)

Manufacturers: AEG (MAN)
AEG/Kiepe

Vehicle Type: GT6N

Category: 3

Ordered: 12

Year of Delivery: N/A

CHARACTERISTICS

Car Length: 26.5 m (86.9 ft)

Car Width: 2.3 m (7.5 ft)

Low Floor Area: 100%

Floor Height

High: 350 mm (13.8 in)

Low: 300 mm (11.8 in)

Weight: 26.8 tonnes (59,100 lbs)

Specific Weight: 440 kg/m² (91 lb/ft²)

Seats: 60

Standees: 103 @ 4 pass/m²

CONSTRUCTION

Travel Direction: Unidirectional

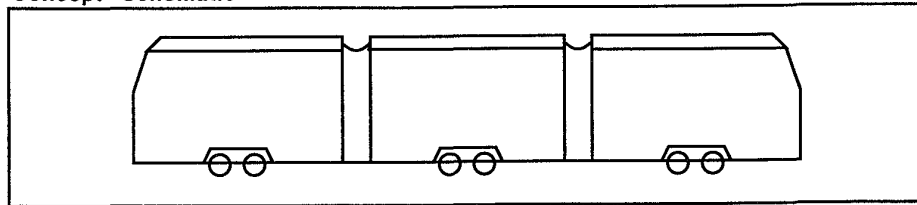
Doors: Four Double

Articulation: Floating

Body Material: Stainless Steel

Buff Load: 20 tonnes (44,100 lbs)

Concept Schematic



RUNNING GEAR

Axle Arrangement: 1A'A1'A1'

Power Wheel Diameter: 680 mm (26.8 in)

Power Gear: Independent wheels, one pair driven,
one pair free-wheeling

Trailer Wheel Diameter: N/A

Trailer Gear: N/A

Track Gauge: 1435 mm (56.5 in)

Min Curve Radius: 15 m (49.2 ft)

Max Speed: 70 km/h (44 mph)

PROPULSION

Propulsion Technology: AC

Line Voltage: 600 V

Number of Motors: 3

Total Power: 252 kW (338 hp)

Specific Power: 9.4 kW/tonne (11.4 hp/ton)

BRAKES

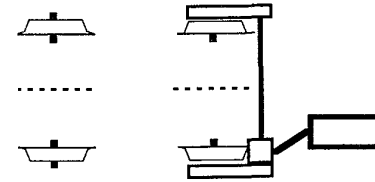
1. Regenerative
2. Spring Loaded Disc

PRICE DATA

Cost Density: N/A

Vehicle Cost: N/A

Powered Running Gear



Trailing Running Gear

APPENDIX B

NORTH AMERICAN LRT SYSTEMS DATABASE

North American LRT Systems

LRT System Platform	Baltimore	Boston (Green Line)	Boston (Mattapan)	Chicago (Circulator)	Cleveland	Newark	Philadelphia (City Transit)
	Low	Low	Low	Low	Low	Low	Low
I. Platform							
ADA Features	WSR/FDP	N	N	BF	N	N	N
Passenger Stations and Car Stops	21	70	8	32	29	11	187
Platform Height above TOR, mm (inches)	102 (4.0)	0	0	356 (14.0)	203 (8.0)	203 (8.0)	0
II. Right of Way							
One-Way Line, km (miles)	41.8 (26.0)	40.1 (24.9)	4.3 (2.7)	16.4 (10.2)	21.1 (13.1)	6.9 (4.3)	35.9 (22.3)
Right of Way Reserved	95%	89%	100%	100%	100%	100%	16%
Average Station Spacing, km (miles)	2.0 (1.2)	0.6 (0.4)	0.5 (0.3)	0.5 (0.3)	0.7 (0.5)	0.6 (0.4)	0.2 (0.1)
Double Track, km (miles)	22.5 (14.0)	40.1 (24.9)	4.3 (2.7)	12.1 (7.5)	21.1 (13.1)	6.9 (4.3)	35.9 (22.3)
Minimum Track Curve Radius, m (ft)	25 (82)	13 (42)	10 (33)	18 (60)	23 (76)	10 (33)	22 (73)
Maximum Grade	9%	8%	6%	6%	4%	6%	5%
Track Gauge, mm (inches)	1435 (56.5)	1435 (56.5)	1435 (56.5)	1435 (56.5)	1435 (56.5)	1435 (56.5)	1581 (62.25)
Subway/Tunnel, km (miles)		7.2 (4.5)				2.1 (1.3)	4.0 (2.5)
Exclusive, km (miles)		17.1 (10.6)	4.3 (2.7)	0.6 (0.4)	11.3 (7.0)	4.8 (3.0)	
Private Right of Way, km (miles)	39.4 (24.5)			1.0 (0.6)			
Street/Highway Median, km (miles)		11.4 (7.1)		5.8 (3.6)	9.8 (6.1)		1.6 (1.0)
Street Lanes/Malls, km (miles)				9.0 (5.6)			
Mixed Traffic, km (miles)	2.4 (1.5)	4.3 (2.7)					30.3 (18.8)
Total, km (miles)	41.8 (26.0)	40.1 (24.9)	4.3 (2.7)	16.4 (10.2)	21.1 (13.1)	6.9 (4.3)	35.9 (22.3)
III. Systems							
Fare Collection System	Proof of Payment	Gates/Farebox	Gates/Farebox	Proof of Payment	Gates/Farebox	Proof of Payment	Farebox
Traction Power (VDC)	750	600	600	600	600	600	600
Substations: No.	16	11	1	8	6	3	28
Substations: Rating (mW)	1	3.0 - 6.0	6	5-10	1.5 & 3.0	1.175	
Type of Overhead (Cat. or Trolley)	Catenary	Catenary	Trolley	Catenary	Catenary	Trolley	Trolley
Signals: Block (% of line)	95%	61%	100%	--	60%	100%	11%
Signals: Traffic (% of line)	5%	39%	--	100%	47%	<1%	89%

ADA FEATURES: CL = Carborne Life; FDP = Fold Down Platform; WSL = Wayside Lift; WSRr = Wayside Ramp;
BF = Barrier Free; N = None

North American LRT Systems

LRT System Platform	Baltimore	Boston (Green Line)	Boston (Mattapan)	Chicago (Circulator)	Cleveland	Newark	Philadelphia (City Transit)
	Low	Low	Low	Low	Low	Low	Low
IV. Operations							
System Average Speed, km/h (mph)	24.1 (15.0)	20.9 (13.0)	19.3 (12.0)	16.1 (10.0)	29.0 (18.0)	29.0 (18.0)	17.7 (11.0)
Through Routes	1	4	1	4	2	1	5
Fleet	35	173	6	45	48	24	112
Cars/Train	3	3	1	2	3	1	1
Single/Double Ended	Double	Double	Single	Double	Double	Single	Single
Total Number Seats	84	50	52	50	84	54	51
Capacity (4 passengers/sq. m)	200	130	83	186	144	83	90
Maximum Speed, km/h (mph)	89 (55)	80 (50) [84 (52)]	72 (45)	56 (35)	97 (60)	72 (45)	80 (50)
Acceleration, m/s ² (mph/sec)	1.3 (3.0)	1.23 (2.8) [1.32 (3.0)]	1.8 (4.0)	1.3 (3.0)	1.3 (3.0)	2.1 (4.8)	1.3 (3.0)
V. Vehicle							
Car Type	6-Axle LRV	6-Axle LRV	4-Axle St. Car	6-Axle LRV	6-Axle LRV	4-Axle St. Car	4-Axle St. Car
Access/No. of Steps	Low/3	Low/3	Low/3	Low	Low/3	Low/2	Low/3
Manufacturer	ABB	Kinki [Boeing]	Various	Not yet chosen	Breda	St. Louis	Kawaski
Length, m (ft)	29.0 (95.0)	21.9 (72.0)	14.0 (46.0)	27.4 (90.0)	24.4 (80.0)	14.0 (46.0)	15.2 (50.0)
Width, m (ft)	2.9 (9.5)	2.7 (8.9)	2.5 (8.3)	2.7 (9.0)	2.8 (9.3)	2.7 (8.8)	2.6 (8.5)
Height, m (ft)	3.8 (12.5)	3.6 (11.7)	3.1 (10.3)	3.4 (11.2)	3.5 (11.3)	3.3 (10.9)	3.4 (11.0)
Floor Height above TOR, mm (inches)	1016 (40.0)	889 (35.0)	838 (33.0)	356 (14.0)	1016 (40.0)	838 (33.0)	914 (36.0)
Weight, tonnes (tons)	44.4 (49.0)	38.1 (42.0) [29.9 (33.0)]	17.2 (19.0)	37.0 (40.8)	40.8 (45.0)	17.2 (19.0)	26.3 (29.0)
Air Conditioning	Yes	Yes	No	Yes	Yes	No	Yes
ATS (separation)/ATO (operation)	No	No	No	No	ATS	No	No
Propulsion	AC	CC	DCCC	AC	DC	CC	DC
Brakes	D F T R	D F T	D F T	D F	D F T	D F T	D F T
Communications	P R	R I P V	R	P I R	P I	R	P

PROPULSION: CC=Cam Control; DC=DC Chopper; DDCC=Dual DC Chopper;
AC=AC Inverter; W=Westinghouse Accelerator (Rheostatic)

BRAKES: D=Dynamic; R=Regenerative; F=Friction; A=Air; T=Track

COMMUNICATIONS: P=PA; A=Announce; I=Intercom; R=Radio; V=AVI

North American LRT Systems

LRT System Platform	Philadelphia (Media, Sharon Hill)	Pittsburgh	Portland	Sacramento	San Diego	Santa Clara
	Low	Low	Low	Low	Low	Low
I. Platform						
ADA Features	N	N	WSL	WSR/FDP	CL	WSL
Passenger Stations and Car Stops	38	15	30	28	30	33
Platform Height above TOR, mm (inches)	0	178 (7.0)	254 (10.0)	0	152 (6.0)	140 (5.5)
II. Right of Way						
One-Way Line, km (miles)	53.5 (33.3)	6.4 (4.0)	24.3 (15.1)	29.4 (18.3)	54.6 (33.9)	32.2 (20.0)
Right of Way Reserved	87%	100%	99%	84%	100%	100%
Average Station Spacing, km (miles)	1.4 (0.9)	0.4 (0.3)	0.8 (0.5)	1.1 (0.7)	1.8 (1.1)	1.0 (0.6)
Double Track, km (miles)	13.7 (8.5)	4.2 (2.6)	21.6 (13.4)	28.5 (17.7)	32.7 (32.7)	30.9 (19.2)
Minimum Track Curve Radius, m (ft)	25 (82)	25 (82)	25 (82)	25 (82)	27 (90)	25 (82)
Maximum Grade		9%	7%	7%	3%	7%
Track Gauge, mm (inches)	1581 (62.25)	1600 (63.0)	1435 (56.5)	1435 (56.5)	1435 (56.5)	1435 (56.5)
Subway/Tunnel, km (miles)						
Exclusive, km (miles)			8.7 (5.4)	9.5 (5.9)		15.8 (9.8)
Private Right of Way, km (miles)		6.4 (4.0)	3.7 (2.3)	12.4 (7.7)	51.0 (31.7)	1.8 (1.1)
Street/Highway Median, km (miles)			8.4 (5.2)	1.0 (0.6)	1.6 (1.0)	13.5 (8.4)
Street Lanes/Malls, km (miles)			3.4 (2.1)	1.8 (1.1)	1.9 (1.2)	1.1 (0.7)
Mixed Traffic, km (miles)			0.2 (0.1)	4.8 (3.0)		
Total, km (miles)	53.5 (33.3)	6.4 (4.0)	24.3 (15.1)	29.4 (18.3)	54.6 (33.9)	32.2 (20.0)
III. Systems						
Fare Collection System	Farebox	Gates/Farebox	Proof of Payment	Proof of Payment	Proof of Payment	Proof of Payment
Traction Power (VDC)	635	640	750	750	600	750
Substations: No.	4	6	14	14	20	15
Substations: Rating (mW)		6	0.75	1	0.5 & 1.0	1.5
Type of Overhead (Cat. or Trolley)	Trolley	Catenary	Both	Both	Both	Both
Signals: Block (% of line)	50%	100%	52%	77%	91%	58%
Signals: Traffic (% of line)	25%	---	48%	23%	9%	42%

ADA FEATURES: CL = Carborne Life; FDP = Fold Down Platform; WSL = Wayside Lift; WSRr = Wayside Ramp;
BF = Barrier Free; N = None

North American LRT Systems

LRT System Platform	Philadelphia (Media, Sharon Hill)	Pittsburgh	Portland	Sacramento	San Diego	Santa Clara
	Low	Low	Low	Low	Low	Low
IV. Operations						
System Average Speed, km/h (mph)	25.7 (16.0)	25.7 (16.0)	30.6 (19.0)	33.8 (21.0)	29.0 (18.0)	32.2 (20.0)
Through Routes	2	1	1	1	2	2
Fleet	29	16	30	35	150	55
Cars/Train	2	1	2	4	1 to 4	2
Single/Double Ended	Double	Single	Double	Double	Double	Double
Total Number Seats	50	50	76	60	64	75
Capacity (4 passengers/sq. m)	95	83	160	144	150	160
Maximum Speed, km/h (mph)	100 (62)	72 (45)	89 (55)	80 (50)	80 (50)	89 (55)
Acceleration, m/s ² (mph/sec)	1.3 (3.0)	1.8 (4.0)	1.3 (3.0)	1.1 (2.5)	1.0 (2.2)	1.3 (3.0)
V. Vehicle						
Car Type	4-Axle St. Car	4-Axle St. Car	6-Axle LRV	6-Axle LRV	6-Axle LRV	6-Axle LRV
Access/No. of Steps	Low/3	Low/3	Low/3	Low/3	Low/3	Low/3
Manufacturer	Kawaski	St. Louis	Bombardier	Siemens	Siemens/Duewag	UTDC
Length, m (ft)	16.2 (53.0)	14.0 (46.0)	27.1 (89.0)	24.4 (80.0)	24.4 (80.0)	27.1 (89.0)
Width, m (ft)	2.6 (8.5)	2.7 (8.8)	2.6 (8.7)	2.7 (8.8)	2.6 (8.7)	2.6 (8.7)
Height, m (ft)	3.4 (11.0)	3.1 (10.3)	3.4 (11.2)	3.3 (10.9)	3.3 (10.9)	3.4 (11.2)
Floor Height above TOR, mm (inches)	914 (36.0)	838 (33.0)	991 (39.0)	991 (39.0)	991 (39.0)	991 (39.0)
Weight, tonnes (tons)	27.2 (30.0)	17.2 (19.0)	41.7 (46.0)	27.2 (30.0)	32.7 (36.0)	44.4 (49.0)
Air Conditioning	Yes	No	No	Yes	Yes	Yes
ATS (separation)/ATO (operation)	No	No	ATS	No	No	No
Propulsion	DC	CC	CC	CC	CC	CC
Brakes	DFT	DFT	DFT	DFT	DFT	DFT
Communications	P	PR	PI	P	PA	PI

PROPULSION: CC=Cam Control; DC=DC Chopper; DDCC=Dual DC Chopper;
AC=AC Inverter; W=Westinghouse Accelerator (Rheostatic)

BRAKES: D=Dynamic; R=Regenerative; F=Friction; A=Air; T=Track

COMMUNICATIONS: P=PA; A=Announce; I=Intercom; R=Radio; V=AVI

North American LRT Systems

LRT System Platform	Toronto	Toronto	Toronto	Buffalo	Pittsburgh	San Francisco	San Francisco
	Low	Low	Low	Low/High	Low/High	Low/High	Low/High
I. Platform							
ADA Features	N	N	N	WSR	BF	BF, WSR, N	BF, WSR, N
Passenger Stations and Car Stops	624	<--see	<--see	14	68	204	<--see
Platform Height above TOR, mm (inches)	0	<--see	<--see	0	949 (37.4)	152 (6.0)	<--see
II. Right of Way							
One-Way Line, km (miles)	79.5 (49.4)	<--see	<--see	10.0 (6.2)	38.0 (23.6)	35.6 (22.1)	<--see
Right of Way Reserved	10%	<--see	<--see	100%	85%	40%	<--see
Average Station Spacing, km (miles)	0.1 (0.1)	<--see	<--see	0.7 (0.4)	0.6 (0.3)	0.2 (0.1)	<--see
Double Track, km (miles)	78.0 (48.5)	<--see	<--see	10.0 (6.2)	38.0 (23.6)	35.6 (22.1)	<--see
Minimum Track Curve Radius, m (ft)	11 (36)	<--see	<--see	23 (75)	25 (82)	13 (42)	14 (45)
Maximum Grade	8%	<--see	<--see	6%	9%	9%	<--see
Track Gauge, mm (inches)	1495 (58.875)	<--see	<--see	1435 (56.5)	1600 (63.0)	1435 (56.5)	<--see
Subway/Tunnel, km (miles)	1.1 (0.7)	<--see	<--see	8.4 (5.2)	1.0 (0.6)	10.3 (6.4)	<--see
Exclusive, km (miles)							
Private Right of Way, km (miles)	6.4 (4.0)	<--see	<--see		31.4 (19.5)	1.3 (0.8)	<--see
Street/Highway Median, km (miles)	4.0 (2.5)	<--see	<--see			2.6 (1.6)	<--see
Street Lanes/Malls, km (miles)				1.6 (1.0)			
Mixed Traffic, km (miles)	67.9 (42.2)	<--see	<--see		5.6 (3.5)	21.4 (13.3)	<--see
Total, km (miles)	79.5 (49.4)	<--see	<--see	10.0 (6.2)	38.0 (23.6)	35.6 (22.1)	<--see
III. Systems							
Fare Collection System	Farebox	Farebox	Farebox	Proof of Payment	Gates/Farebox	Gates/Farebox	Gates/Farebox
Traction Power (VDC)	580	<--see	<--see	650	640	600	<--see
Substations: No.	1	<--see	<--see	5	6	12	<--see
Substations: Rating (mW)	6	<--see	<--see	2	6	2-8	<--see
Type of Overhead (Cat. or Trolley)	Trolley	<--see	<--see	Catenary	Catenary	Trolley	
Signals: Block (% of line)	---	---	---	81%	85%	19%	<--see
Signals: Traffic (% of line)	100%	<--see	<--see	19%	15%	81%	<--see

ADA FEATURES: CL = Carborne Life; FDP = Fold Down Platform; WSL = Wayside Lift; WSRr = Wayside Ramp;
BF = Barrier Free; N = None

North American LRT Systems

LRT System Platform	Toronto	Toronto	Toronto	Buffalo	Pittsburgh	San Francisco	San Francisco
	Low	Low	Low	Low/High	Low/High	Low/High	Low/High
IV. Operations							
System Average Speed, km/h (mph)	14.2 (8.8)	<--see	<--see	27.4 (17.0)	22.5 (14.0)	17.7 (11.0)	<--see
Through Routes	10	<--see	<--see	12	4	5	<--see
Fleet	52	196	19	27	55	128	
Cars/Train	1	1	1	3	2	3	3
Single/Double Ended	Single	Single	Single	Double	Double	Double	Double
Total Number Seats	61	46	45	51	62	68	60
Capacity (4 passengers/sq. m)	205	132	134	121	151	130	130
Maximum Speed, km/h (mph)	80 (50)	80 (50)	68 (42)	80 (50)	80 (50)	84 (52)	80 (50)
Acceleration, m/s ² (mph/sec)	1.2 (2.7)	1.5 (3.3)	1.6 (3.6)	1.3 (3.0)	1.3 (3.0)	1.3 (3.0)	1.3 (3.0)
V. Vehicle							
Car Type	6-Axle LRV	4-Axle LRV	4-Axle St. Car	4-Axle St. Car	6-Axle LRV	6-Axle SLRV	6-Axle LRV
Access/No. of Steps	Low/3	Low/3	Low/2	High/Low	High/Low	High/Low	High/Low
Manufacturer	UTDC	UTDC	C.C. & F. Co.	Tokyu	Siemens	Boeing	Breda
Length, m (ft)	23.2 (76.0)	15.5 (51.0)	14.0 (46.0)	20.4 (67.0)	25.6 (84.0)	21.9 (72.0)	22.9 (75.0)
Width, m (ft)	2.6 (8.5)	2.6 (8.5)	2.5 (8.3)	2.6 (8.6)	2.7 (8.8)	2.7 (8.8)	2.7 (9.0)
Height, m (ft)	3.4 (11.0)	3.4 (11.0)	3.0 (10.0)	3.4 (11.2)	3.3 (10.9)	3.5 (11.3)	3.5 (11.5)
Floor Height above TOR, mm (inches)	940 (37.0)	940 (37.0)	838 (33.0)	940 (37.0)	1016 (40.0)	864 (34.0)	864 (34.0)
Weight, tonnes (tons)	36.3 (40.0)	22.7 (25.0)	17.2 (19.0)	29.9 (33.0)	36.3 (40.0)	29.9 (33.0)	32.2 (35.5)
Air Conditioning	No	No	No	Yes	Yes	No	Yes
ATS (separation)/ATO (operation)	No	No	No	ATS	ATS	ATS	Cab Signal
Propulsion	DC	DC	W	DC	DC	DC	AC
Brakes	R A T	R A T	D F T	D F T	D F T	D F T	D F T
Communications	P	P	P	P I A	P R	P I	P I

PROPULSION: CC=Cam Control; DC=DC Chopper; DDCC=Dual DC Chopper;
AC=AC Inverter; W=Westinghouse Accelerator (Rheostatic)

BRAKES: D=Dynamic; R=Regenerative; F=Friction; A=Air; T=Track

COMMUNICATIONS: P=PA; A=Announce; I=Intercom; R=Radio; V=AVI

North American LRT Systems

LRT System Platform	Calgary	Edmonton	Los Angeles (Blue Line)	Philadelphia (Norristown)	St. Louis
	High	High	High	High	High
I. Platform					
ADA Features	BF	BF	BF	BF	BF
Passenger Stations and Car Stops	31	11	22	22	19
Platform Height above TOR, mm (inches)	914 (36.0)	965 (38.0)	991 (39.0)	1067 (42.0)	1016 (40.0)
II. Right of Way					
One-Way Line, km (miles)	29.3 (18.2)	12.4 (7.7)	35.4 (22.0)	21.4 (13.3)	28.2 (17.5)
Right of Way Reserved	100%	100%	100%	100%	100%
Average Station Spacing, km (miles)	0.9 (0.6)	1.1 (0.7)	1.6 (1.0)	1.0 (0.6)	1.5 (0.9)
Double Track, km (miles)	29.3 (18.2)	12.4 (7.7)	35.4 (22.0)	21.4 (13.3)	26.4 (16.4)
Minimum Track Curve Radius, m (ft)	21 (69)	25 (82)	27 (90)		25 (82)
Maximum Grade	6%	6%	6%	3%	6%
Track Gauge, mm (inches)	1435 (56.5)	1435 (56.5)	1435 (56.5)	1435 (56.5)	1435 (56.5)
Subway/Tunnel, km (miles)	1.9 (1.2)	4.2 (2.6)	0.8 (0.5)		1.8 (1.1)
Exclusive, km (miles)	1.3 (0.8)				
Private Right of Way, km (miles)	13.2 (8.2)	8.2 (5.1)	29.8 (18.5)	21.4 (13.3)	26.4 (16.4)
Street/Highway Median, km (miles)	10.5 (6.5)		3.2 (2.0)		
Street Lanes/Malls, km (miles)	2.4 (1.5)		1.6 (1.0)		
Mixed Traffic, km (miles)					
Total, km (miles)	29.3 (18.2)	12.4 (7.7)	35.4 (22.0)	21.4 (13.3)	28.2 (17.5)
III. Systems					
Fare Collection System	Proof of Payment	Proof of Payment	Proof of Payment	Farebox	Farebox
Traction Power (VDC)	600	600	750	600	750
Substations: No.	17	9	21	4	12
Substations: Rating (mW)	2	1.5 & 3.0	1.5 & 3.0	3	
Type of Overhead (Cat. or Trolley)	Catenary	Catenary	Both	3rd Rail	Catenary
Signals: Block (% of line)	92%	100%	86%	100%	Cab Signal
Signals: Traffic (% of line)	8%	--	14%	--	

ADA FEATURES: CL = Carborne Life; FDP = Fold Down Platform; WSL = Wayside Lift; WSRr = Wayside Ramp;
BF = Barrier Free; N = None

North American LRT Systems

LRT System Platform	Calgary	Edmonton	Los Angeles (Blue Line)	Philadelphia (Norristown)	St. Louis
	High	High	High	High	High
IV. Operations					
System Average Speed, km/h (mph)	29.0 (18.0)	30.6 (19.0)	33.8 (21.0)	54.7 (34.0)	37.0 (23.0)
Through Routes	3	1	1	1	1
Fleet	85	37	54	26	31
Cars/Train	3	3	3	1	3
Single/Double Ended	Double	Double	Double	Double	Double
Total Number Seats	64	64	76	60	72
Capacity (4 passengers/sq. m)	162	162	160		200
Maximum Speed, km/h (mph)	80 (50)	80 (50)	89 (55)	113 (70)	89 (55)
Acceleration, m/s ² (mph/sec)	1.0 (2.2)	1.0 (2.2)	1.3 (3.0)	1.3 (3.0)	1.3 (3.0)
V. Vehicle					
Car Type	6-Axle LRV	6-Axle LRV	6-Axle LRV	4-Axle St. Car	6-Axle LRV
Access/No. of Steps	High	High	High	High	High
Manufacturer	Siemens	Siemens	Nippon-Sharyo	ABB/MK	Siemens
Length, m (ft)	24.4 (80.0)	24.4 (80.0)	27.1 (89.0)	19.8 (65.0)	27.4 (89.8)
Width, m (ft)	2.6 (8.6)	2.6 (8.7)	2.7 (8.8)	3.0 (9.8)	2.6 (8.7)
Height, m (ft)	3.4 (11.2)	3.3 (10.9)	3.5 (11.5)	4.3 (14.0)	3.6 (11.8)
Floor Height above TOR, mm (inches)	965 (38.0)	965 (38.0)	991 (39.0)	1067 (42.0)	1016 (40.0)
Weight, tonnes (tons)	31.7 (35.0)	40.8 (45.0)	42.6 (47.0)	35.6 (39.3)	40.8 (45.0)
Air Conditioning	No	No	Yes	Yes	Yes
ATS (separation)/ATO (operation)	ATS	ATS	ATS	ATS	No
Propulsion	CC	CC	DC	AC	DC
Brakes	DFT	DFT	DFT	DFR	DFTR
Communications	PIA	PA	PI	PR	PIR

PROPULSION: CC=Cam Control; DC=DC Chopper; DDCC=Dual DC Chopper;
AC=AC Inverter; W=Westinghouse Accelerator (Rheostatic)

BRAKES: D=Dynamic; R=Regenerative; F=Friction; A=Air; T=Track

COMMUNICATIONS: P=PA; A=Announce; I=Intercom; R=Radio; V=AVI

APPENDIX C

GLOSSARY

ADA	Americans With Disabilities Act—refers to legislation passed in 1991 regarding access to transit by persons with disabilities	CTA	Chicago Transit Authority; Chicago, Illinois
Axle Arrangements	<p>B Monomotor, four wheel truck</p> <p>Bo Bimotor, four wheel truck</p> <p>A Motored, two wheel truck</p> <p>2 Four wheel trailer truck</p> <p>1 Two wheel trailer truck</p>	ET	Edmonton Transit; Edmonton, Alberta, Canada
CBD	Central Business District	DART	Dallas Area Rapid Transit; Dallas, Texas
EEF	Einzelrad-Einzel-Fahrwerk wheelsets, self steering and independently rotating wheel	GCRTA	Greater Cleveland Regional Transit Authority; Cleveland, Ohio
HVAC	Heating, ventilating and air conditioning	LACMTA	Los Angeles County Metropolitan Transportation Authority; Los Angeles, California
LF-LRV	Low-floor light rail vehicle	MBTA	Massachusetts Bay Transportation Authority; Boston, Massachusetts
LRT	Light rail transit—refers to an operator or system using light rail vehicles	MTA	Maryland Mass Transit Administration; Baltimore, Maryland
LRV	Light rail vehicle	MTDB	San Diego Metropolitan Transit Development Board; San Diego, California
POP	Proof-of-payment fare collection system	MUNI	San Francisco Municipal Railway; San Francisco, California
Specific Mass (kg/m^2)	$= \frac{\text{Mass (kg)}}{\text{Car Length (m)} \times \text{Car Width (m)}}$	NFTA	Niagara Frontier Transportation Authority; Buffalo, New York
Specific Weight (lb/ft^2)	$= \frac{\text{Weight (lbs)}}{\text{Car Length (ft)} \times \text{Car Width (ft)}}$	NJT	New Jersey Transit; Newark, New Jersey
T1-T8/ M1-M10	Classification system for wheelsets and drive arrangements for both conventional LRVs and the three categories of LF-LRVs	PAT	Port Authority of Allegheny County; Pittsburgh, Pennsylvania
Ton	Unit of Weight, 1 Ton equals 2000 lbs	RT	Sacramento Regional Transit District; Sacramento, California
Tonne	Metric Ton, Unit of Mass, 1 Tonne equals 1000 kg	SCCTA	Santa Clara County Transportation Agency; San Jose, California
TOR	Top of (the running) rail—an industry standard used for vertical measurement	SEPTA	Southeastern Pennsylvania Transportation Authority; Philadelphia, Pennsylvania
		TRI-MET	Tri-County Metropolitan Transportation District; Portland, Oregon
		TTC	Toronto Transit Commission; Toronto, Ontario, Canada
LIST OF TRANSIT AUTHORITIES		VDV	German Association of Public Transport Operators
CT	Calgary Transit; Calgary, Alberta, Canada		

APPENDIX D

BIBLIOGRAPHY

I ARTICLES FROM URBAN TRANSPORTATION JOURNALS

1. De Steur. Der Straßenbahnwagen ZGT-6 der RET. In *Der Nahverkehr*, April 1983.
2. Grosz, Meschede. Geräuschminderung durch Radsatzsteuerung im Gleisbogen. In *Der Nahverkehr*, January 1988.
3. Koffman, Losradlaufwerke. In *Der Stadtverkehr*, March 1984.
4. Koffman. Das Kleine Rad der Genfer Straßenbahnwagen. In *Der Stadtverkehr*, August 1984.
5. Ebnother. Straßenbahn-Eigelenk-Triebwagen Be 4/6 in Niederflurbauweise des TPG mit Gleichstromsteller für 600 V. In *BBC-Mitteilungen*, December 1984.
6. P. Tappy. Die Genfer Niederflur-Strassenbahn. In *UITP Revue*, Vol. 33, 1984.
7. J. D. Latona. Buffalo Joins the Light Rail League. In *Railway Gazette International*, January 1985.
8. G. Vianello. Low-Floor Carrying Bogie for Light Rail Vehicles. In *Ingegneria Ferroviaria*, March 1985.
9. Frederich. Spurführung in engen Gleisbögen. In *Der Nahverkehr*, February 1985.
10. L. Boschetto. Die Strassenbahn-Baureihe Turin. In *Stadtverkehr*, Vol. 11-12, 1986.
11. Anonymous. Fiat Shows Turin Tram. In *International Railway Journal*, February 1986.
12. F. Frederich. Bau and Erprobung eines Einzelrad-Eiselfahrwerks. In *Nahverkehrsforschung Bonn*, 1987.
13. G. Püttner. VÖV-Niederflur-Stadtbahn, Entwurf von Prototypfahrzeugen. In *Nahverkehrsforschung Bonn*, 1987.
14. Karch. Der Düsseldorfer Stadtbahnwagen B80D in Alu-Bauweise. In *Stadtverkehr*, February 1987.
15. Ahlbrecht, Müller-Hellman. Renaissance der Niederflur-Fahrzeuge bei Straßen- und Stadtbahnen. In *Der Nahverkehr*, May 1987.
16. Frederich. Experiment zur Spurführung. In *Glaser's Annalen*, June 1987.
17. D. Catling. Higher Standards and Lower Floors in the Light Rail Car Market. In *Railway Gazette International*, September 1987.
18. J. Blancher, J. M. Kuntzer and R. Ruget. Grenoble Brings Back the Tram. In *Railway Gazette International*, September 1987.
19. BLT, Vogt. Gelenktriebwagen Be 4/8 mit Niederflur-Mittelteil in Betrieb. In *Stadtverkehr*, October 1987.
20. Espagno. Le TAG, une realisation exemplaire. In *Chemins de Fer*, January 1988.
21. Bergner. Reduzierung des Bogenverschleißes durch Zwangssteuerungen. In *Der Nahverkehr*, January 1988.
22. A. Mueller-Hermann and R. Alfter. Low Floors and No Axles. In *Railway Gazette International*, March 1988.
23. G. Hutschenreuther and L. Uebel. Der Niederflur-Wagen GT 6 N der Bremer Strassenbahn AG. In *Der Nahverkehr*, Vol. 3, 1988.
24. P. Lehmann. Das Würzberger Konzept für Strassenbahn-Niederflurwagen. In *Der Nahverkehr*, Vol. 4, 1988.
25. Anonymous. Gemeinsames Beschaffungsprogramm von vier Privatbahnen. In *Schweizer Eisenbahn-Revue*, April 1988.
26. G. Muller. TAG Revitalises Grenoble Area. In *International Railway Journal*, May 1988.
27. Anonymous. Low-Floor Tram Designs Multiply. In *International Railway Journal*, May 1988.
28. Berger. Niederflur-Doppelgelenk-Trams für die Verkehrsbetriebe Bern. In *Der Nahverkehr*, May 1988.
29. P. Goldsack, ed. European Light Rail Review. In *Mass Transit*, June 1988.
30. Anonymous. Entwicklergemeinschaft VÖV-Biederflur-Stadtbahn. In Veröffentlichung der SNV/LTRC/VÖV, June 1988.
31. Neugebauer. Ein neuartiges Umrickerkonzept für Nahverkehrsfahrzeuge mit Gleichstromspeisung. In *Der Nahverkehr*, June 1988.
32. Siegloch/Bader. Straßenbahn in Kassel hat Zukunft. In *Stadtverkehr*, August 1988.
33. I. Yearsley. Mind the Gap! How Greater Manchester's Tony Young is Tackling the LRT Platform Height Problem. In *Urban Transport International*, July/August 1988.
34. D. F. Frederich. A Bogie Concept for the 1990s. In *Railway Gazette International*, September 1988.
35. R. Alfter, et al. VOeV Low-Floor Light Rail Transit Car. In *Zeitschrift fuer Eisenbahnwesen und Verkehrstechnik*, November 1988.
36. Berger, Carrying bogie undergoing trials in Berne tram. In *VeVeY Technical Bulletin*, 1989.
37. Hondius, ÖPNV-Niederflurfahrzeuge im Kommen. In *Stadtverkehr*, February 1989.
38. L. Uebel, E. Weeger, and L. Mauer. Das Fahrwerk des Niederflur-Gelenktriebwagens GT 6 N. In *Der Nahverkehr*, Vol 2, 1989.
39. W. D. Middleton. Light Rail: The Affordable Alternative. In *Railway Age*, February 1989.
40. C. Stucki, M. Dunand, and E. Grasset. Die Genfer Niederflur-Strassbahn. In *Der Nahverkehr*, Vol. 3, 1989.
41. Anonymous. From Low-Floor Tram to Low-Floor Train. In *Railway Gazette International*, May 1989.
42. Bader. Niederflur-Straßenbahnen für Kassel. In *Der Nahverkehr*, May 1989.
43. H. Heinz and R. Zettner. Würzburgs Niederflur-Stadtbahnwagen. In *Der Nahverkehr*, Vol. 6, 1989.
44. Anonymous. Low-Floor Tram Innovations. In *International Railway Journal*, July 1989.

45. Hondius. Niederflurfahrzeugentwicklungen von VeVeY. In *Stadtverkehr*, September 1989.
46. H. Hondius. Freiburg beschafft 11 Stadtbahnwagen mit Niederflur-Mittelteil. In *Stadtverkehr*, Vol. 9, 1989.
47. Hondius. Die erste Niederflurversion für Überlandbahnen - Zehn Fahrzeuge für die Centovallibahn. In *Stadtverkehr*, September 1989.
48. Hondius. Niederflurbusse auf der IAA '89 in Frankfurt. Eine aktuelle Übersicht über den Stand der Entwicklung. In *Stadtverkehr*, October 1989.
49. F. Dalliard. New Double-Articulated Low-Floor Tram for the Berne Public Transport Authority. In *Technical Bulletin Vevey*, 1990.
50. R. Bradley. Travelling Light. In *Engineering*, 1990.
51. Anonymous. Melbourne Builds and Integrated Network. In *Developing Metros 1990*, 1990.
52. C. Descours. Grenoble Trams Breed Success. In *Developing Metros 1990*, 1990.
53. J. F. Tjon a Ten. Amsterdam to Inaugurate Light Rail to Amstelveen. In *Developing Metros 1990*, 1990.
54. I. Yearsley. Much Change and Mixed Fortunes. In *Transport*, 1990.
55. Anonymous. Low-Floor LRVs Gain in Popularity. In *International Railway Journal*, January 1990.
56. Anonymous. Low-Floor LRVs Arrive. In *International Railway Journal*, January 1990.
57. Anonymous. Low-Floor LRV's. In *International Railway Journal*, January 1990.
58. Anonymous. Die Neuen Gelenktriebwagen für Amsterdam. In *Stadtverkehr*, Vol. 1-2, 1990.
59. Ahlbrecht. Ein leichter Stadtbahnwagen. In *Der Nahverkehr*, February 1990.
60. Bauer. Straßenbahn in der DDR. In *Der Nahverkehr*, February 1990.
61. F. Daillard. Laefwerke von Vevey für Niederflur-Stadtbahnwagen. In *Der Nahverkehr*, Vol. 3, 1990.
62. H. Hondius. Europe Refines the Low-Floor Tram. In *Railway Gazette International*, March 1990.
63. Hondius. Eine Niederflur-Entwicklung der belgischen Bombardier-BN-Werke. In *Der Nahverkehr*, April 1990.
64. Jarne. Die elektrische Ausrüstung der neuen Tramwagen für die SVB etc. In *Schweizer Eisenbahn-Revue*, April 1990.
65. Wiebelhaus and A. Brinkmann. Von Komponenten zu Systemen. In *Der Nahverkehr*, May 1990.
66. Stanke. Antriebssteuerung und -regelung der EEF-Antriebe. In *Der Nahverkehr*, May 1990.
67. Hondius. ÖPNV-Niederflur-Fahrzeuge im Kommen (2). In *Stadtverkehr*, May 1990.
68. Brinkmann and Wiebelhaus. Von Komponenten zu Systemen. Innovative Lösungen der Antriebs-, Fahrwerks-, Brems- und Kupplungstechnik für Schienenfahrzeuge des Nahverkehrs. In *Der Nahverkehr*, May 1990.
69. H. Hondius. BN Boards Low-Floor Bandwagon. In *Railway Gazette International*, June 1990.
70. Anonymous. Italy. In *International Railway Journal*, July 1990.
71. Kunow and Freiburg. Neue Stadtbahn-Wagen mit Niederflur-Mittelteil. In *Stadtverkehr*, July 1990.
72. Anonymous. Disabilities Act Could Strain Transit Budgets. In *Railway Age*, September 1990.
73. Anonymous. Les essais du LTV 2000 à Bruxelles. In *TRAM 2000*, October 1990.
74. Höltge and S. Höltge. Großraum-, Gelenk-, Stadtbahn- und Nf-Wagen. For *Stadtverkehr*, November-December 1990.
75. M. Taplin. Low-Floor LRV Progress. In *Light Rail Review*, 1991.
76. Lehotzky. Niederflur-U-Bahn-Wagen für Wien. In *Der Nahverkehr*, 24/91.
77. G. Hutschenreuther and L. Uebel. Niederflur-Strassenbahn Prototyp für München. In *Stadtverkehr*, Vol. 1, 1991.
78. Kunow. In Kassel vorgestellt: neue Niederflur-Straßenbahn. In *Stadtverkehr*, January 1991.
79. H. Hondius. Stadtbahn 2000 to Roll in the Spring. In *Railway Gazette International*, January 1991.
80. Hondius. VÖV-Niederflur-Stadtbahn-Wagen 2000. In *Stadtverkehr*, January 1991.
81. G. Püttner. Prototypes of the VoeV Lightweight Low-Floor Stadtbahn Vehicle. In *Zeitschrift fuer Eisenbahnwesen und Verkehrstechnik*, January/February 1991.
82. Anonymous. Duewag to Assemble Sheffield Trams. In *Railway Gazette International*, March 1991.
83. A. Müller-Hellmann. Präsentation von Prototypen der VÖV-Niederflur-Stadtbahn. In *Der Nahverkehr*, March 1991.
84. H. Fiedler. Münchens neue Straßenbahn. In *Der Nahverkehr*, March 1991.
85. P. Lehotzky. Niederflur-U-Gabn-Wagen für Wien. In *Der Nahverkehr*, March 1991.
86. F. Frederich. Niederflur-Strassenbahnwagen der Zukunft. In *Nahverkehrspraxis*, Vol. 4, 1991.
87. Brinkmann and Geers. Niederflurwagen Kassel: DUEWAG-BSI Einzelrad-Einzelfahrwerk. In *Stadtverkehr*, May-June 1991.
88. Bader and Maurer. Kasseler Niederflur-Fahrzeuge im Linieneinsatz. Betriebliche Anforderungen und erste Erfahrungen. In *Stadtverkehr*, May-June 1991.
89. Hondius. Präsentation der VDV-Stadtbahn-Wagen. In *Stadtverkehr*, May-June 1991.
90. Kohler. Niederflur-Fahrzeuge für Frankfurt am Main. In *Stadtverkehr*, May-June 1991.
91. A. Hellawell. Aluminium Invades Europe's Main Line Coach Market. In *Railway Gazette International*, June 1991.

92. Anonymous. VDV Prototypes Reach the Testing Stage. In *Railway Gazette International*, June 1991.
93. Bayer and Kleim. Nerb: Eine neue Straßenbahngeneration für München - Prototypfahrzeuge der Baureihe R 1.1 Siemens Sonderdruck 119100-V500-B390. In *Elektrische Bahnen*, June 1991.
94. Anonymous. Congress Launches Innovative Designs. In *Railway Gazette International*, July 1991.
95. Hondius. GVBA, Entwicklung des Wagenparks der Straßenbahn nach 1945. In *Stadtverkehr*, August 1991.
96. Van 't Hoogerhuijs. Start der Stadtbahn in Sheffield. In *Stadtverkehr*, August 1991.
97. Anonymous. Transports, l'an 2001 en Ile-de-France. In *La Vie du Rail*, August 1991.
98. Hondius. UITP-Kongreß und Ausstellung in Stockholm. In *Stadtverkehr*, September 1991.
99. J. Schöber and H. Weidelt. The Prototype VOV Low-Floor Light Rail Vehicle. In *Verkehr und Technik*, September 1991.
100. Anonymous. Bruxelles: que sera le nouveau tramway? La STIB achète des trams ... 2000! In *TRAM 2000*, September and November 1991.
101. H. Kuchwalek. Tiefstlur-Tram für Wien. In *Stadtverkehr*, Vol. 10, 1991.
102. H. Hondius. Low-Floor Development Out of Control. In *Railway Gazette International*, November 1991.
103. Anonymous. Low-Floor Centre Sections: Easy Access at Low Cost. In *Urban Transport International*, November/December 1991.
104. L. O'Connor. Light Rail Vehicles: The Trolley's Time Has Come - Again. In *Mechanical Engineering*, December 1991.
105. Prevost. Straßenbahnwagen in Alu-Profilbauweise für Nantes. In *Aluminium Schienenfahrzeuge*, Hestra Verlag, 1992.
106. Anonymous. Low-Floor LRV Designs Abound. Edited extracts of *Through The Cities-The Revolution in Light Rail* by M. Barry. In *International Railway Journal*, January 1992.
107. Anonymous. Turin Tests Firema LRV. In *International Railway Journal*, January 1992.
108. Anonymous. Ultra Low-Floor LRV. In *International Railway Journal*, January 1992.
109. Anonymous. Curve-Friendly LRV. In *International Railway Journal*, January 1992.
110. Anonymous. BWS Develops New Concept. In *International Railway Journal*, January 1992.
111. Anonymous. Low-Floor LRV Orders. In *International Railway Journal*, January 1992.
112. Muller. Le tramway de Strasbourg. Description sommaire du matériel roulant. In *Chemins de Fer*, February 1992.
113. Kratz. Modulare elektrische Ausrüstungen für AEG-Niederflurfahrzeuge. In *Der Nahverkehr*, April 1992.
114. Hondius. ÖPNV-Nf-Fahrzeuge im Kommen (3), Teil II. In *Stadtverkehr*, April 1992.
115. Ihle et al. Eine "Supertram" für Sheffield. In *Der Nahverkehr*, April 1992.
116. Geers. Entwicklung der Drehgestelltechnik für Niederflurfahrzeuge im Nahverkehr. In *Der Nahverkehr*, May 1992.
117. Wood. Low floors or eastern promis. Fleet modernisation in Oslo. In *Light Rail and Modern Tramway*, July 1992.
118. Gabatguler, Welte and Havenith. Neue Nf-Pendelzüge für den Regionalverkehr. Technische Aspekte aus der Sicht des Herstellers des mechanischen Teils. In *Schweizer Eisenbahn-Revue*, July-August 1992.
119. Lenk and F. Proksch. Neue Fahrwerke zur Niveauabsenkung des Fahrgastfußbodens des schienengeführten Stadtverkehrsmittels. In *Glaser's Annalen*, August/September 1992.
120. H. Hondius. Axles Abandoned to Accommodate Low Floors. In *Railway Gazette International*, September 1992.
121. Anonymous. Nantes inaugure la seconde ligne du tramway. L'effect reseau. In *Transport Public*, September 1992.
122. H. Hondius. Low Floor Car Orders Continue to Climb. In *Railway Gazette International*, October 1992.
123. Bendien et al. Konsolidierung der Drehstromantiebstechnik für Schienenfahrzeuge. In *Elektrische Bahnen*, November 1992.
124. Anonymous. The North American Overview: Robust Growth Continues (Urban Light Rail Systems). In *Railway Age*, February 1993.
125. W. D. Middleton. The New Age of Light Rail Vehicles. In *Railway Age*, February 1993.
126. Anonymous. Revised Passenger Car Market At-a-Glance. In *Railway Age*, April 1993.
127. Anonymous. Light-Rail Firm Close to Big Deal. In *Sacramento Bee*, April 15, 1993.
128. Anonymous. Portland Opts for Siemens Light Rail Vehicles. In *Progressive Railroading*, May 1993.
129. Anonymous. Portland (Tri-Met). In *Railway Age*, May 1993.
130. Anonymous. Amtrak to Test High-Speed Rail Technology from Germany. In *Journal of Commerce*, May 10, 1993.
131. Anonymous. Ultra Low LRT Just Six Inches Off the Ground. In *Public Innovation Abroad*, June 1993.
132. W. C. Vantuono. Tri-Met Goes Low-Floor. In *Railway Age*, July 1993.
133. Anonymous. State Grants Under Threat. In *International Railway Journal*, July 1993.
134. Anonymous. Marseille Plans for the Future. In *International Railway Journal*, July 1993.
135. Anonymous. SNCF Supports Light Rail. In *International Railway Journal*, July 1993.
136. Anonymous. New LRVs Improve Image. In *International Railway Journal*, July 1993.
137. Anonymous. First US Low-Floor LRVs. In *International Railway Journal*, July 1993.

138. Anonymous. Sister System in Sheffield. In *Mass Transit*, July/August 1993.
139. M. Taplin, Low-Floor Light Rail Vehicles. In *Light Rail Review*, No. 1.
140. M. Taplin, Low-Floor Light Rail Vehicles. In *Light Rail Review*, No. 2.

II. SPECIAL REPORTS AND PAPERS

141. J. Schumann. Evaluations of Operating Light Rail Transit and Streetcar Systems in the United States. In *Special Report 182: Light Rail Transit: Planning and Technology*, TRB, National Research Council, Washington, D.C., 1978.
142. Anonymous. What is Light Rail Transit? In *This is LRT*, TRB, National Research Council, Washington, D.C., 1989.
143. J. Schumann. What's New in North American Light Rail Projects? In *Special Report 221: Light Rail Transit: New System Successes at Affordable Prices*, TRB, National Research Council, Washington, D.C., 1989.
144. M. T. Burns. Wheelchair Accessibility on the MBTA's Light Rail System - Is It Feasible? Presented at the APTA 1990 Rapid Transit Conference, Vancouver, B.C., June 1990.
145. F. Giorgetti and F. Pontanari. VLC - Very Light Rail Vehicle. Presented at the APTA Rapid Transit Conference, Vancouver, B.C., June 1990.
146. J. W. Schumann. Low-Floor LRV's: Wave of the Future or Flash in the Pan? Presented at the APTA Rapid Transit Conference, Vancouver, B.C., June 1990.
147. *ETG-Fachbericht 31: Niederflur-Stadtbahnwagen*. Proceedings of a conference held in Kassel, Germany, March 1990.
148. J. W. Schumann. Status of North American LRT Systems: 1992 Update. In *Transportation Research Record 1361*, TRB, National Research Council, Washington, D.C., 1992.
149. J. von Rohr. Low-Floor Light Rail Vehicle Development in Europe. In *Transportation Research Record 1361*, TRB, National Research Council, Washington, D.C., 1992.
150. T. J. Potter. Stockholm's Plans for LRT in the Suburbs. In *Transportation Research Record 1361*, TRB, National Research Council, Washington, D.C., 1992.
151. S. Pont and J. G. Boak. South Yorkshire Supertram. In *Transportation Research Record 1361*, TRB, National Research Council, Washington, D.C., 1992.
152. H. H. Geissenheimer. Paris New Light Rail System: Operation Strategy. In *Transportation Research Record 1361*, TRB, National Research Council, Washington, D.C., 1992.
153. Breda Costruzioni Ferroviarie S.p.A. VLC - Very Light Rail Car.
154. Siemens AG. Low-Floor Tramcar, Type R, with Water-cooled Wheel Hub Drives and Transistorized Converters. For Stadtwerke Frankfurt/Main.
155. Siemens AG. Würzburgs Niederflur-Stadtbahnwagen: Der GT8/8C - Ein Fharzeug für Steilstreckenbetrieb.
156. Siemens AG. Low-Floor Tramcar, Type NGT6C. For Kassel.
157. Siemens AG. Low Floor 8-Axle Light Rail Vehicle. For South Yorkshire Supertram Ltd.
158. Siemens AG. Eight-Axle Articulated Light Rail Vehicle with all Axles Powered. For the Würzburger Straßenbahn GmbH.
159. Siemens AG. Niederflur-Straßenbahnwagen Typ NF6D der Bochum-Gelsenkirchener Straßenbahnen AG.
160. MAN GHH. Low-Floor-Level Light-Rail Vehicle. For Munich.
161. Ateliers de Constructions Mécaniques de Vevey S.A. Articulated Low-Floor Rail Car BE 4/6.
162. Ateliers de Constructions Mécaniques de Vevey S.A. Articulated Low-Floor Rail Car BE 4/8.
163. BN division of Bombardier Eurorail. LRV 2000.
164. Alsthom. Metro Ligero de Grenoble.
165. Firema Consortium Engineering. T61/T62 Low-Floor Articulated LRV for Milan.
166. FIAT Ferroviaria Savigliano. Low-Floor Streetcar. For Turin.
167. FIAT Ferroviaria. Lowfloor trams.
168. ABB Transportation Ltd., Eurotram 100 % Low Floor for CTS Strasbourg.
169. Siemens/Duewag low floor Type MGT 6 D for Halle.
170. SGP/Siemens/Elin/Porche ULF (ultra low floor) for Vienna.
171. Socimi. S-350 LRV, Tramway and subway low floor vehicles.
172. Schindler Waggon, SIG. low floor meter gauge, type COBRA Be 2/3, Be 4/4, Be 4/6.
173. LHB / WBD / ABB Henschel, 8 axles articulated LF-LRV NGT 8 D, for Magdeburg MVB.
174. Duewag / Siemens LF-LRV for Valencia.
175. ABB/Henschel/Wagon Union GmbH-The VARIOTRAM.

IV. LOW FLOOR LRVs TECHNICAL SPECIFICATIONS

176. Request for Proposal for LOW FLOOR LIGHT RAIL VEHICLES Type 2, Westside Light Rail, Contract No. 92-0139R/WC0301, TRI-COUNTY Metropolitan District of Oregon. Conformed May 1993.
177. Draft Specification RVE-001 , NO. 8 GREEN LINE LOW FLOOR CARS, Massachusetts Bay Transportation Authority, December 5, 1991.
178. DESCRIPTION DU VEHICULE V L C POUR LILLE, Annexes au Cahier des Charges Techniques Particulieres (C.C.T.P.), BREDA COSTRUZIONI FERROVIARE.

THE TRANSPORTATION RESEARCH BOARD is a unit of the National Research Council, which serves the National Academy of Sciences and the National Academy of Engineering. It evolved in 1974 from the Highway Research Board which was established in 1920. The TRB incorporates all former HRB activities and also performs additional functions under a broader scope involving all modes of transportation and the interactions of transportation with society. The Board's purpose is to stimulate research concerning the nature and performance of transportation systems, to disseminate information that the research produces, and to encourage the application of appropriate research findings. The Board's program is carried out by more than 270 committees, task forces, and panels composed of more than 3,300 administrators, engineers, social scientists, attorneys, educators, and others concerned with transportation; they serve without compensation. The program is supported by state transportation and highway departments, the modal administrations of the U.S. Department of Transportation, the Association of American Railroads, the National Highway Traffic Safety Administration, and other organizations and individuals interested in the development of transportation.

The National Academy of Sciences is a private, nonprofit, self-perpetuating society of distinguished scholars engaged in scientific and engineering research, dedicated to the furtherance of science and technology and to their use for the general welfare. Upon the authority of the charter granted to it by the Congress in 1863, the Academy has a mandate that requires it to advise the federal government on scientific and technical matters. Dr. Bruce M. Alberts is president of the National Academy of Sciences.

The National Academy of Engineering was established in 1964, under the charter of the National Academy of Sciences, as a parallel organization of outstanding engineers. It is autonomous in its administration and in the selection of its members, sharing with the National Academy of Sciences the responsibility for advising the federal government. The National Academy of Engineering also sponsors engineering programs aimed at meeting national needs, encourages education and research and recognizes the superior achievements of engineers. Dr. Robert M. White is president of the National Academy of Engineering.

The Institute of Medicine was established in 1970 by the National Academy of Sciences to secure the services of eminent members of appropriate professions in the examination of policy matters pertaining to the health of the public. The Institute acts under the responsibility given to the National Academy of Sciences by its congressional charter to be an adviser to the federal government and, upon its own initiative, to identify issues of medical care, research, and education. Dr. Kenneth I. Shine is president of the Institute of Medicine.

The National Research Council was organized by the National Academy of Sciences in 1916 to associate the broad community of science and technology with the Academy's purpose of furthering knowledge and advising the federal government. Functioning in accordance with general policies determined by the Academy, the Council has become the principal operating agency of both the National Academy of Sciences and the National Academy of Engineering in providing services to the government, the public, and the scientific and engineering communities. The Council is administered jointly by both Academies and the Institute of Medicine. Dr. Bruce M. Alberts and Dr. Robert M. White are chairman and vice chairman, respectively, of the National Research Council.