



**The Abdus Salam
International Centre for Theoretical Physics**



2291-30

**Joint ICTP-IAEA Course on Science and Technology of Supercritical
Water Cooled Reactors**

27 June - 1 July, 2011

SUPER LWR and SUPER FR R&D

Yoshiaki Oka

*Waseda University Faculty of Science and Engineering
Department of Nuclear Energy Nishi-Waseda campus
Building 51 11F, 09B, 3-4-1 Ohkubo, Shinjuku-k
Tokyo 169-8555
JAPAN*

Special lecture

Super LWR and Super FR R&D

Yoshiaki Oka

Professor, Joint Department of Nuclear Energy, Waseda University
Emeritus Professor, University of Tokyo

Presentation includes the results of "Research and Development of the Super Fast Reactor" entrusted to Waseda University and University of Tokyo by the Ministry of Education, Culture, Sports, Science at Technology of Japan (MEXT).

Generation IV Reactor Concepts

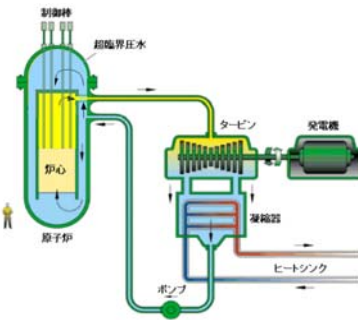

SCWR

(Super LWR / Super FR)

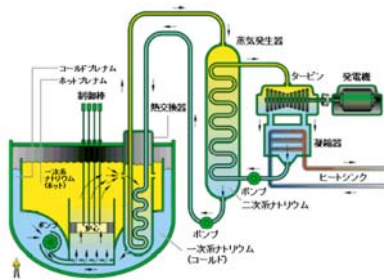

SFR

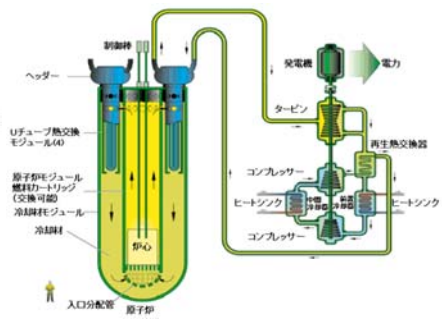

LFR

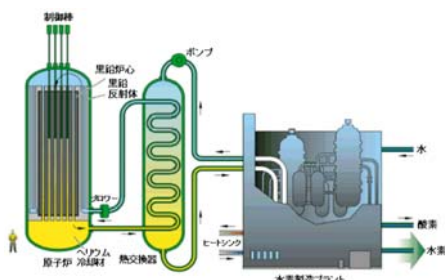

VHTR

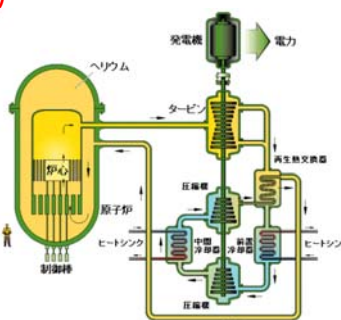

GFR

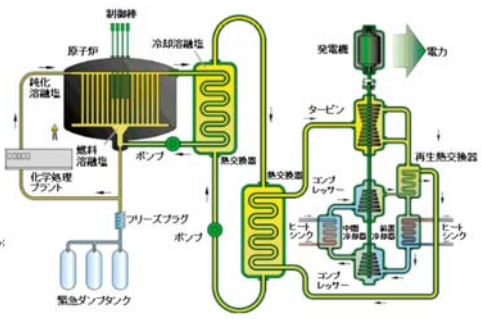

MSR

History of SCWR R&D

- 1989: started study at University of Tokyo, R&D funded by MEXT and METI.
- 1996: Advantage of SCWR reported at Pacific Basin Nuclear Conference in Kobe.
- 1995-96: TEPCO study with Toshiba and Hitachi
- 2000: International symposium of SCR started, (5th in Vancouver in March 2011)
- 2000: 1st phase of HPLWR project started in Europe (3rd Phase now)
- 2000: R&D started in Canada
- 2002: SCWR selected as a Generation 4 reactor
- 2007: R&D started in China
- 2008: IAEA CRP started
- 2010: “ Super LWR & Super FR” book published.

Outline

Super LWR and Super FR study

1. Introduction
2. Fuel and core design
3. Safety
4. Fast reactor
5. R&D

Introduction

What is supercritical water?

- No boiling phenomenon above supercritical pressure
- Continuous density change
- High specific enthalpy

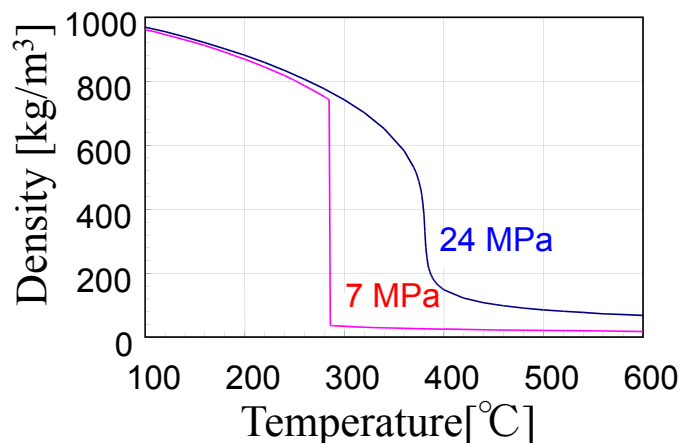
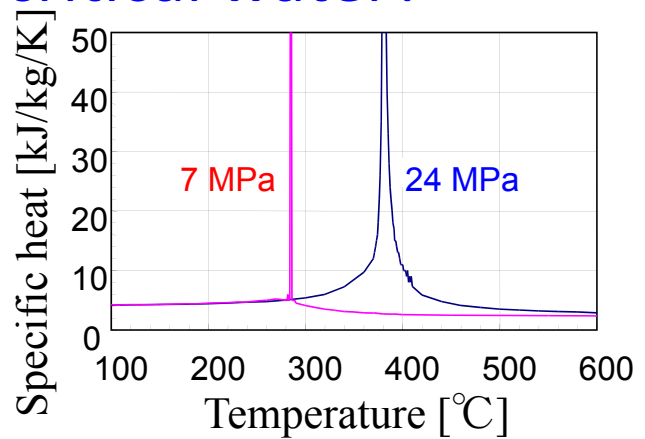
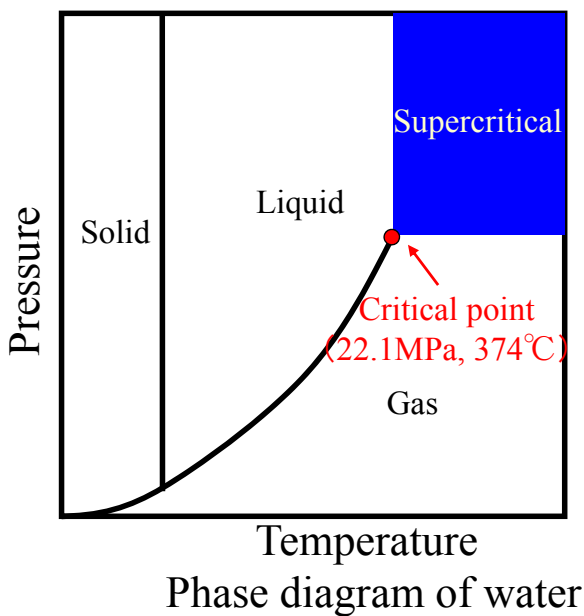

Super LWR and Super FR

- Super LWR: Supercritical-pressure light water cooled and moderated reactor developed at Univ. of Tokyo and Waseda university
- Super FR: Fast reactor version of Super LWR (MOX fuel)
- Once-through direct cycle thermal reactor

- Pressure: 25 MPa
- Inlet: 280°C
- Outlet (average): 500°C
- Flow rate: 1/8 of BWR

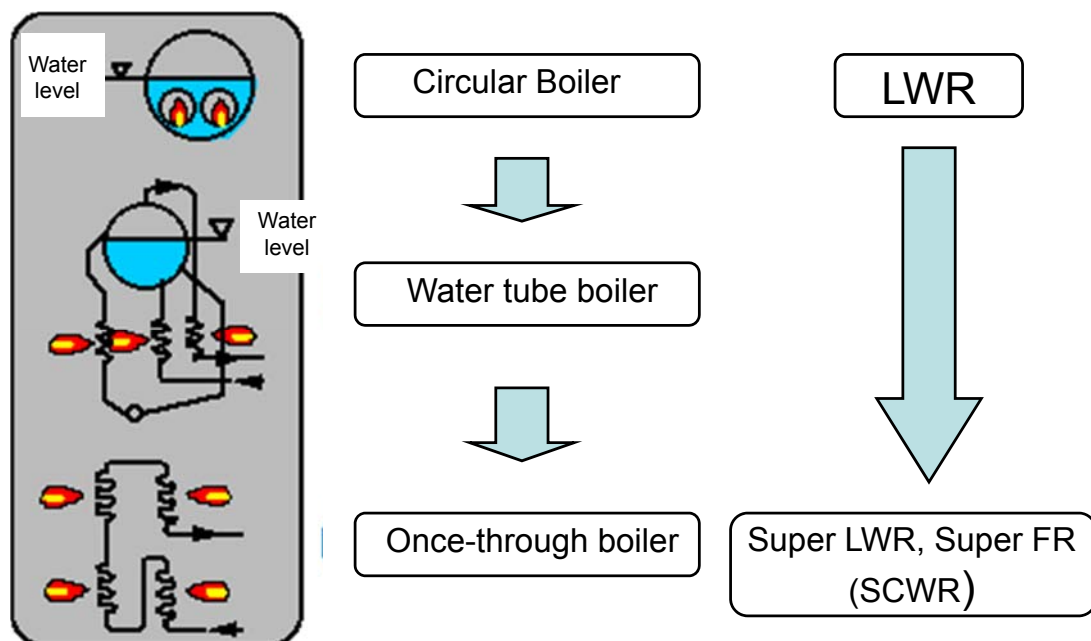
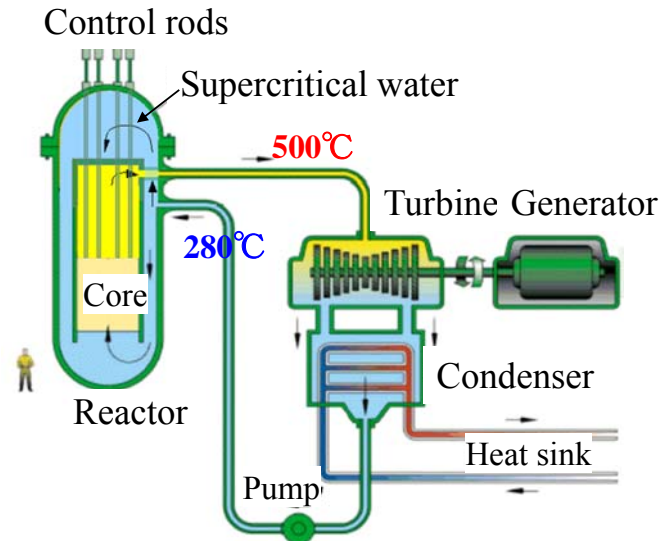

Evolution of boilers

Supercritical fossil-fired power plants

Once-through boilers

Number of units are larger than that of LWRs.

Proven technologies; turbines, pumps, piping etc.

USA; developed in 1950's, Largest unit is 1300MWe.

Japan; deployed in 1960's and constantly improved.

Many plants in Russia and Europe.

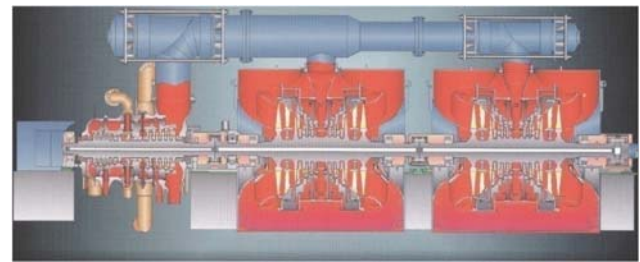

Compact SC turbine (700MWe, 31.0MPa, 566°C)

Purposes of R&D

1. Innovation of light water cooled reactors

Meeting challenges of de-regulated electricity market; Reduce capital investment

Pursuing economic attractiveness of fast reactor over LWR utilizing inherent high power density of fast reactors over LWR without moderators

2. Raising human resources and transferring experience of LWR design and analysis

Conceptual design study of core, fuel, plant control, start-up, stability, safety, heat balance etc. in an integrated manner

Pursue ideas of improvement /optimum design of supercritical water cooled reactors.

Quantify and improve the ideas by computer simulation

Need to do everything by ourselves in considering designs and methods of LWR and fast reactors

Good subject for raising human resources.

Need to pursue innovation of nuclear power plants

- Combined cycle gas turbine (CCGT) power plants are popular due to small capital investment. It is an innovation in power generation utilizing jet engine technology
- Shale gas and shale oil, unconventional resources became competitive. It is abundant domestic resource in USA and will solve energy security problem of CCGT. (Global warming problem remains).
- Large capital cost of NPP does not meet well with the deregulated electricity market.
- Purpose of Super LWR & Super FR design study is to pursue innovation of NPP for capital cost reduction.

Question:

What are the guidelines of concept development of supercritical-pressure light water cooled reactor?

Guidelines of the development

1. Utilize supercritical fossil-fired power plant and LWR technology
2. Minimize large scale-developments of major components
(Keep the temperatures below the experience)
3. Pursue *simplicity* in design

- Pressure: 25 MPa
- Inlet: 280°C
- Outlet (average): 500°C
- Flow rate: 1/8 of BWR Why?

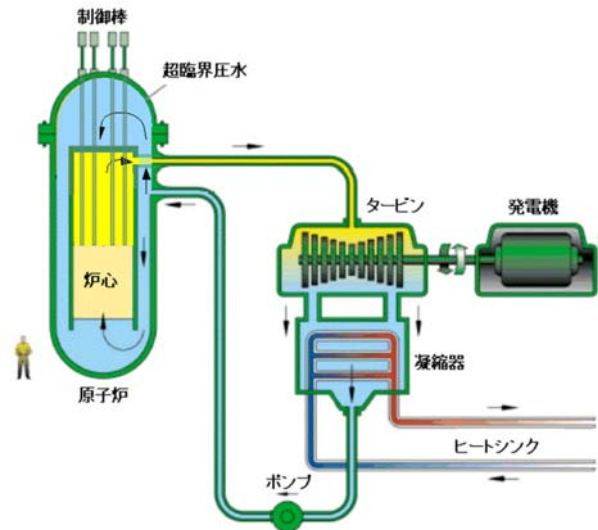

Principle of reactor conceptual design

SCWR is a new reactor not constructed before.

Purpose of the reactor design: To find optimum reactor design of supercritical water cooling.

“Pursuing simplicity” is the principle of guiding the design study. When the simplest design does not meet performance goals, slightly complicated design is pursued by computer simulation.

New method of reactor development by numerical simulation

- Pursue optimum/simple design by numerical calculation
- Priorities of R&D items are determined based on the quantitative results.
- This is a new way of reactor R&D and cost effective.

Features of Super LWR/Super FR

- Compact & simple plant systems; Capital cost reduction
 - No steam/water separation and no SGs: Coolant enthalpy inside CV is small.
 - High specific enthalpy & low flow rate: Compact components
- High temperature & thermal efficiency (500C, ~44%)
- Utilize LWR and Supercritical FPP technologies:
 - Temperatures of major components below the experiences
- Same plant system between thermal and fast reactor

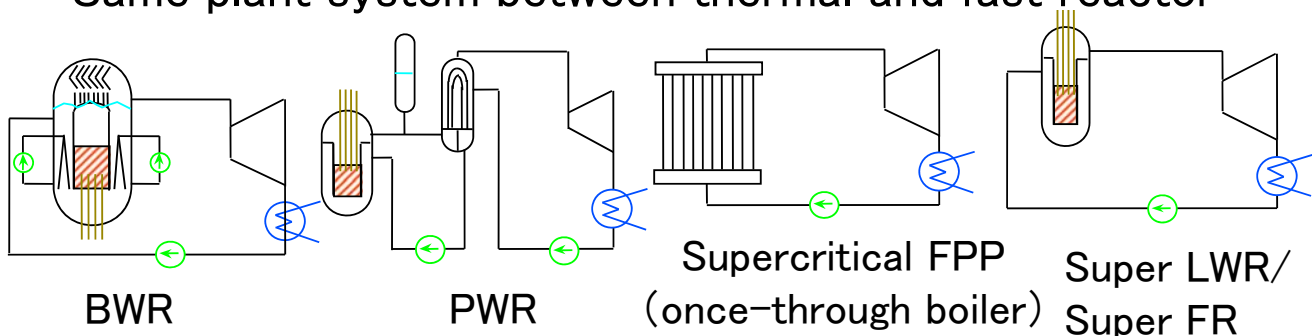

Fuel and core design

At supercritical-pressure:

No boiling phenomena

No boiling transition / dryout / burn out

No critical heat flux

Q1: What limits the design?

Large axial density change:

Q2: How to moderate?

A1: (Cladding) temperature

A2: Water rods, solid moderator like $ZrH_{1.7}$

Fuel assembly design

Design requirements	Solution
Low flow rate per unit power (< 1/8 of LWR) due to large ΔT of once-through system	Narrow gap between fuel rods to keep high mass flux
Thermal spectrum core	Many/Large water rods
Moderator temperature below pseudo-critical	Insulation of water rod wall
Reduction of thermal stress in water rod wall	
Uniform moderation	Uniform fuel rod arrangement

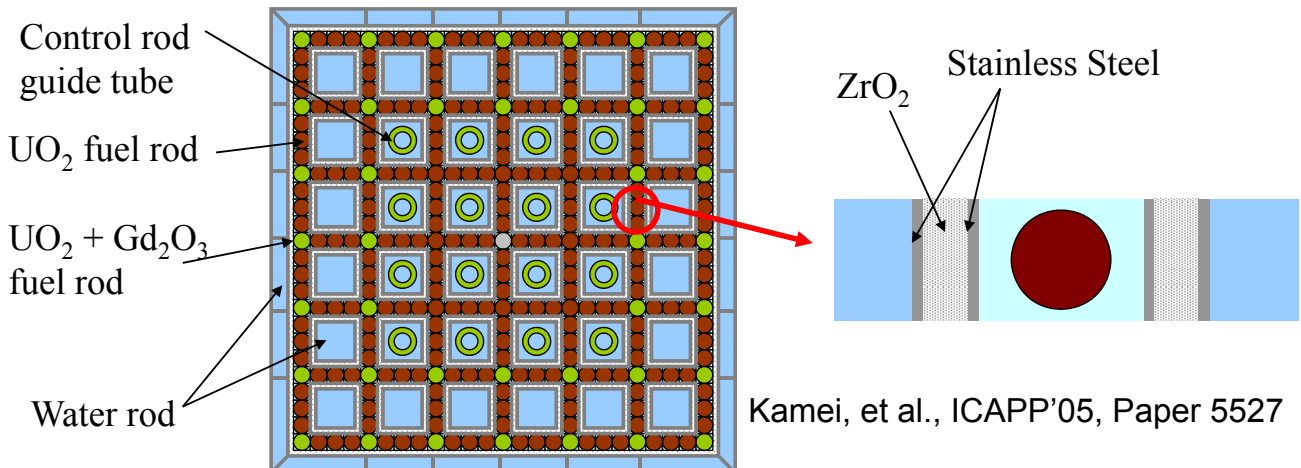

Core design criteria

Thermal design criteria

- Maximum linear heat generation rate (MLHGR) at rated power $\leq 39\text{kW/m}$ What value for LWR? Why 39kW/m for super LWR?
- Maximum cladding surface temperature at rated power $\leq 650\text{C}$ for Stainless Steel cladding
- Moderator temperature in water rods $\leq 384\text{C}$ (pseudo critical temperature at 25MPa) Why?

Neutronic design criteria

- Positive water density reactivity coefficient (negative void reactivity coefficient)
- Core shutdown margin $\geq 1.0\%\Delta k/k$ LWR?

How to estimate maximum cladding temperature?

3-D N-T Coupled Core Calculation

- T-H calculation based on single channel model
- Neutronic calculation; SRAC

Core consists of homogenized fuel elements

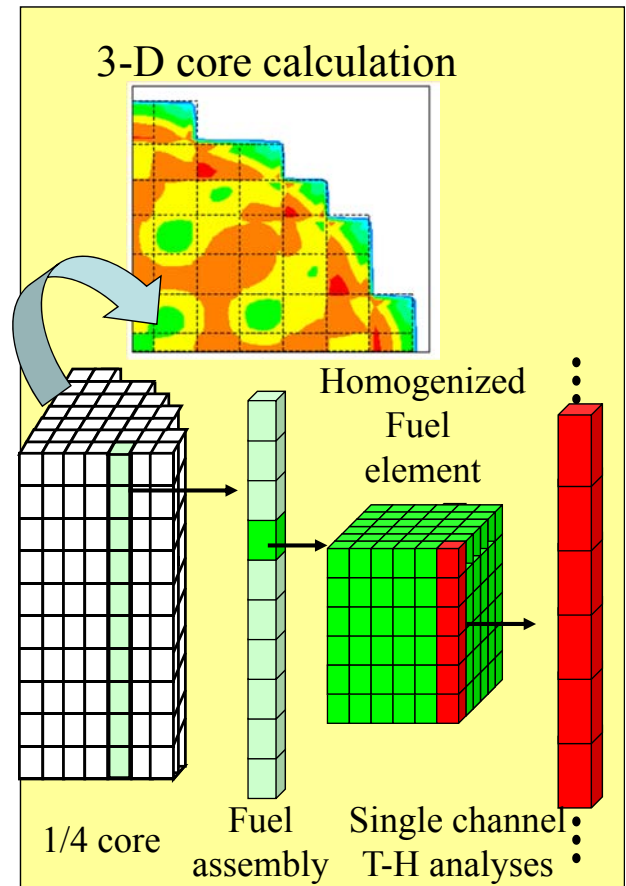
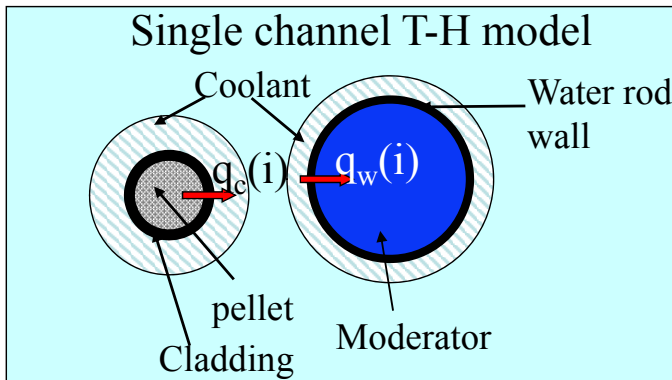

Coolant flow scheme

Flow directions

	Coolant	Moderator
Inner FA	Upward	Downward
Outer FA	Downward	Downward

To keep high average coolant outlet temperature

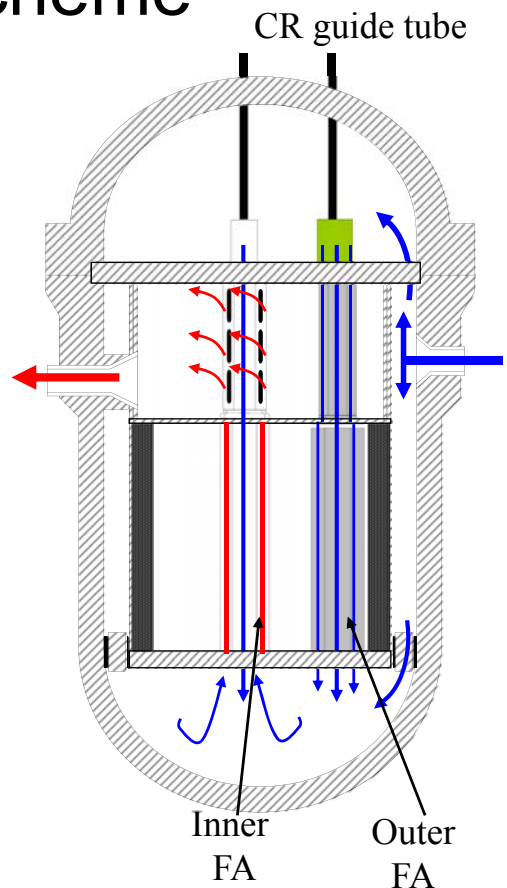
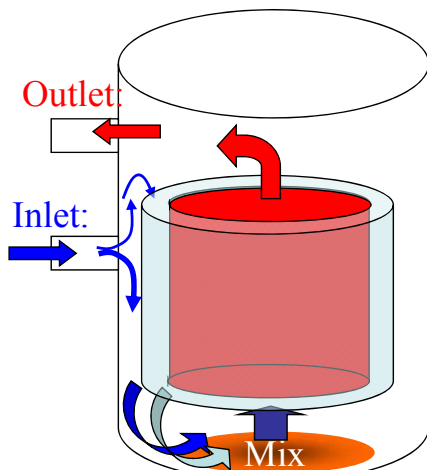

Coolant flow rate distribution

- Flow rate to each FA is adjusted by an inlet orifice
- 48 out of 121FAs are cooled with descending flow

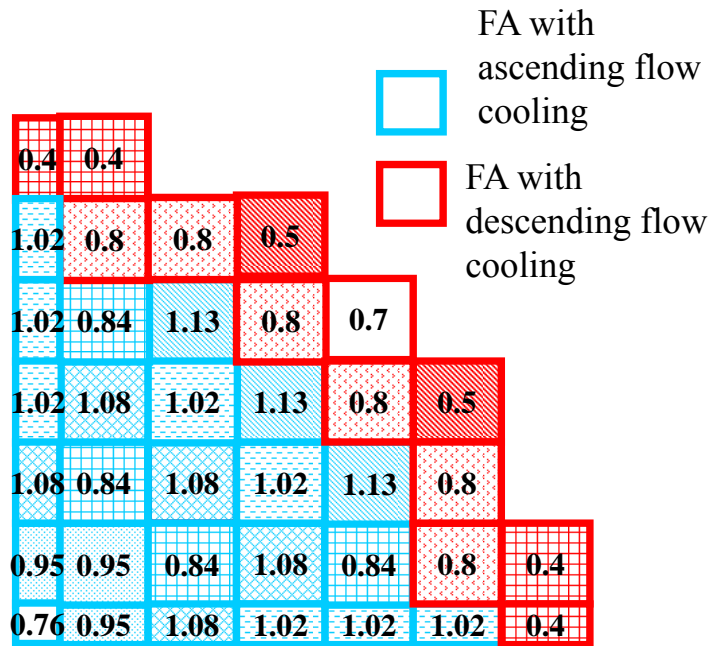

Relative coolant flow distribution (1/4 core)

Fuel load and reload pattern

- 120 FAs of 1st, 2nd and 3rd cycle fuels and one 4th cycle FA
- 3rd cycle FAs which have lowest reactivity are loaded at the peripheral region of the core to reduce the neutron leakage
- This low leakage core is possible by downward flow cooling in peripheral FAs

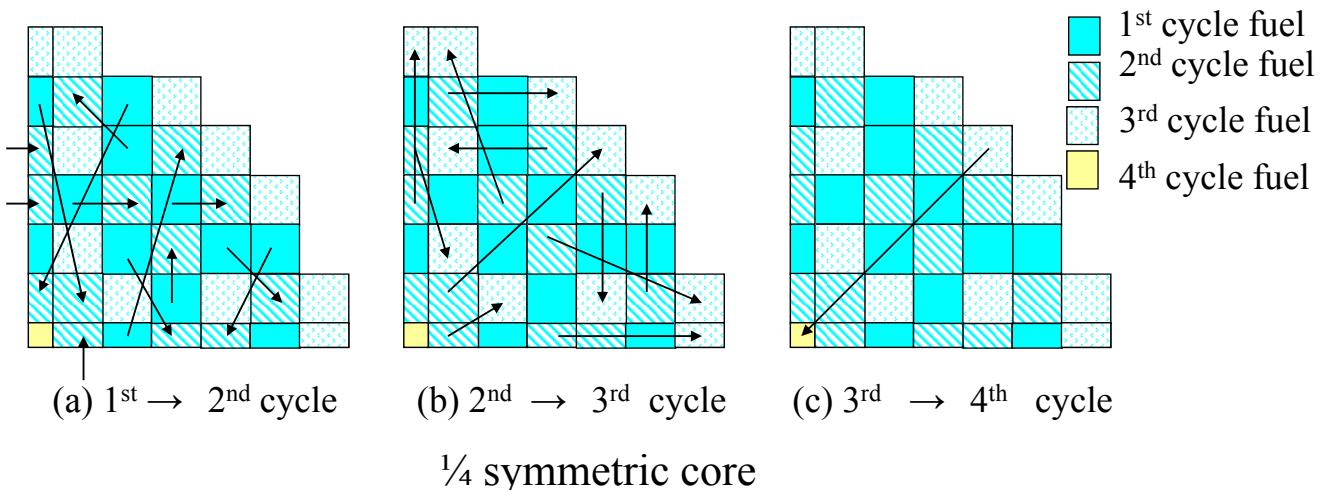

Control rod patterns

- X : withdrawn rate (X/40) Blank box : complete withdrawal (X=40)
- At the EOC, some CRs are slightly inserted to prevent a high axial power peak near the top of the core → Prevent a high MCST

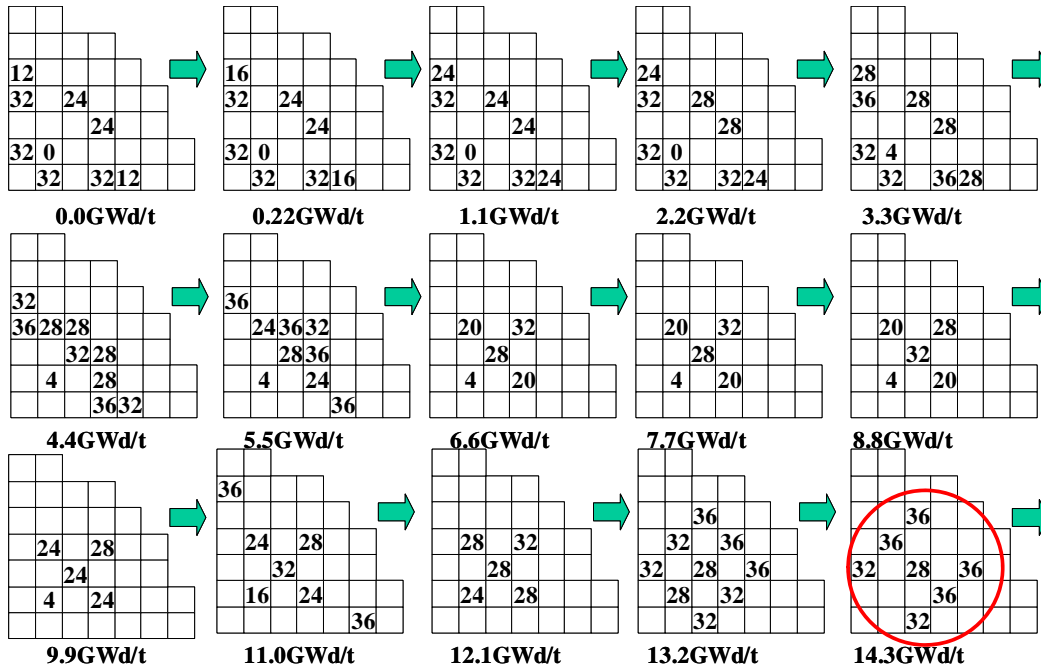

Coolant core outlet temperature and Maximum cladding surface temperature distribution

- Coolant temperature of inner FA is 420-570C (average 500C)
- Coolant temperature of peripheral FA is 350-530C

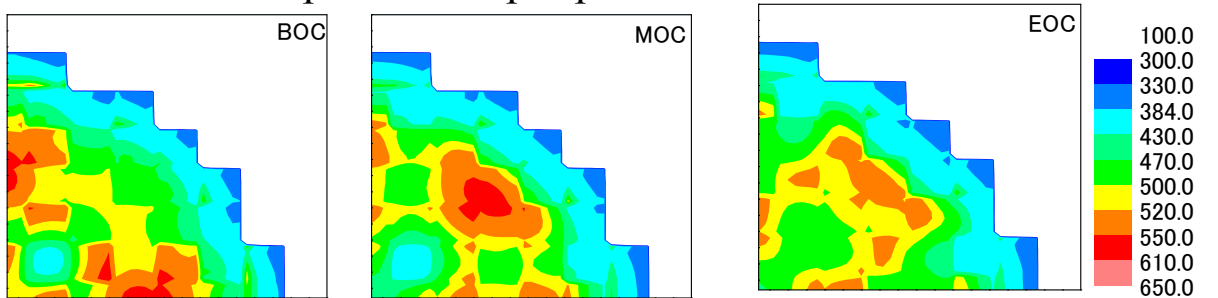

(a) Coolant outlet temperature distribution (1/4 core)

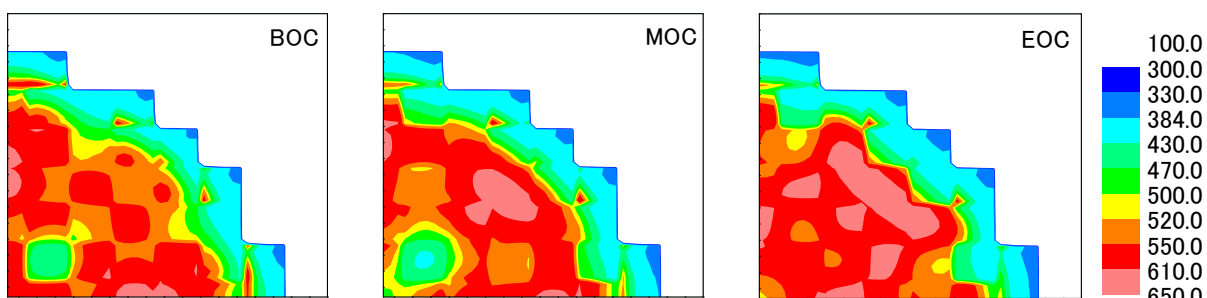

(b) Maximum cladding surface temperature distribution (1/4 core)

MLHGR and MCST

MLHGR and MCST are kept below 39kW/m and 650C throughout a cycle respectively

➡ Thermal design criteria are satisfied

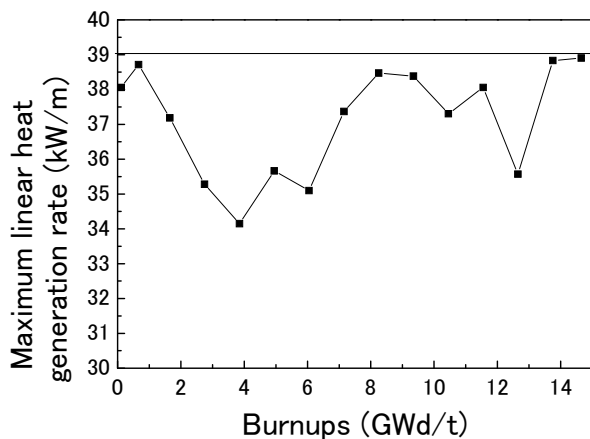

(a) MLHGR

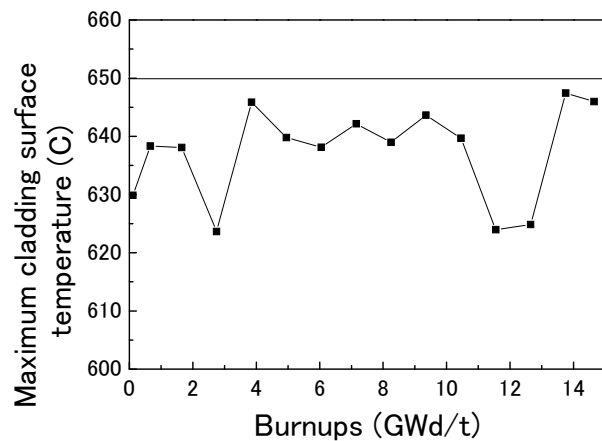

(b) MCST

Water density reactivity coefficient and Shutdown margin

■ Water density reactivity coefficient is **positive** (negative void reactivity coefficient)

■ Shutdown margin is **1.27 %dk/k**

- All CR clusters are inserted except the maximum worth cluster
- Fuel and coolant temperature are 30C
- No Xe or other FP in the core

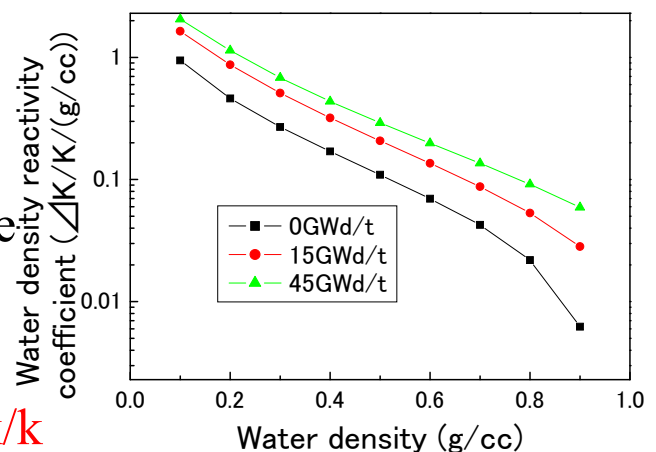

➡ Neutronic design criteria are satisfied

Super LWR characteristics summary

Core	Super LWR
Core pressure [MPa]	25
Core thermal/electrical power [MW]	2744/1200
Coolant inlet/outlet temperature [C]	280/500
Thermal efficiency [%]	43.8
Core flow rate [kg/s]	1418
Number of all FA/FA with descending flow cooling	121/48
Fuel enrichment bottom/top/average [wt%]	6.2/5.9/6.11
Active height/equivalent diameter [m]	4.2/3.73
FA average discharged burnup [GWd/t]	45
MLHGR/ALHGR [kW/m]	38.9/18.0
Average power density [kW/l]	59.9
Fuel rod diameter/Cladding thickness (material) [mm]	10.2/0.63 (Stainless Steel)
Thermal insulation thickness (material) [mm]	2.0 (ZrO ₂)

Principle for Preventing Cladding Failures

- Super LWR: no boiling, limit cladding temperature

	BWR, PWR	Super LWR
Normal operation	Sufficient margin to BT	No creep rupture¹⁾ (Design limit temperature for normal operation)
Abnormal transient	No BT	No plastic strain & no buckling collapse²⁾ (Design limit temperature for abnormal transient)

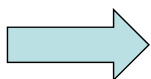

Accurate evaluation of the peak cladding temperature is essential

- 1) A. Yamaji, Y. Oka, J. Yang, et al., "Design and Integrity Analyses of the Super LWR Fuel Rod.," *Proc. Global2005, Tsukuba, Japan (2005)*
- 2) A. Yamaji, Y. Oka, Y. Ishiwatari, et al., "Rationalization of the Fuel Integrity and Transient Criteria for Super LWR," *Proc. ICAPP'05, Seoul, Korea (2005)*

Does the cladding temperature of 3D core calculation show the maximum temperature among fuel rods?

No!

Q3: How to evaluate peak cladding temperature of a fuel rod in a fuel assembly?

A3. Sub-channel analysis coupled with
3 D core calculation

Reconstruction of pin power distributions

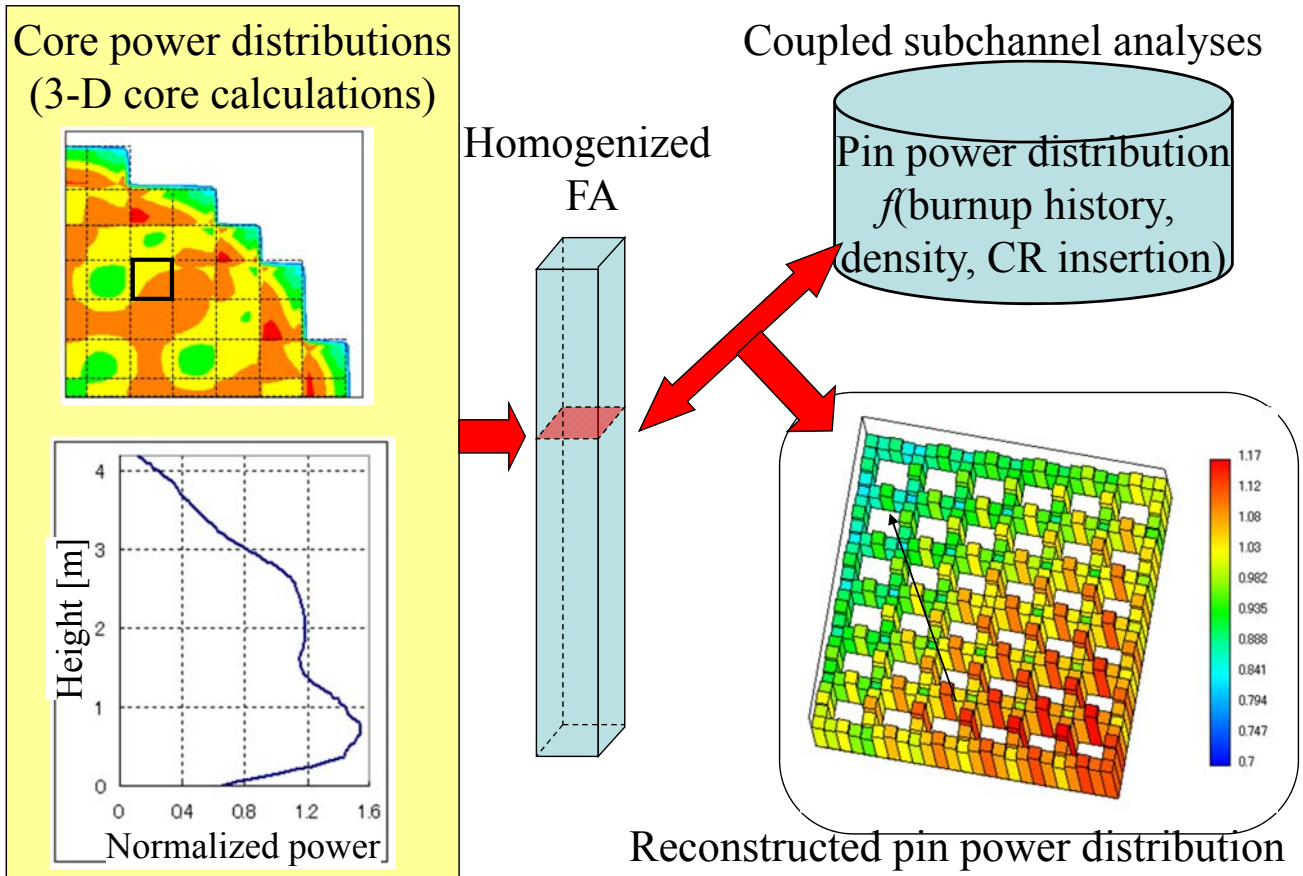

Mass Flux and MCST Distributions

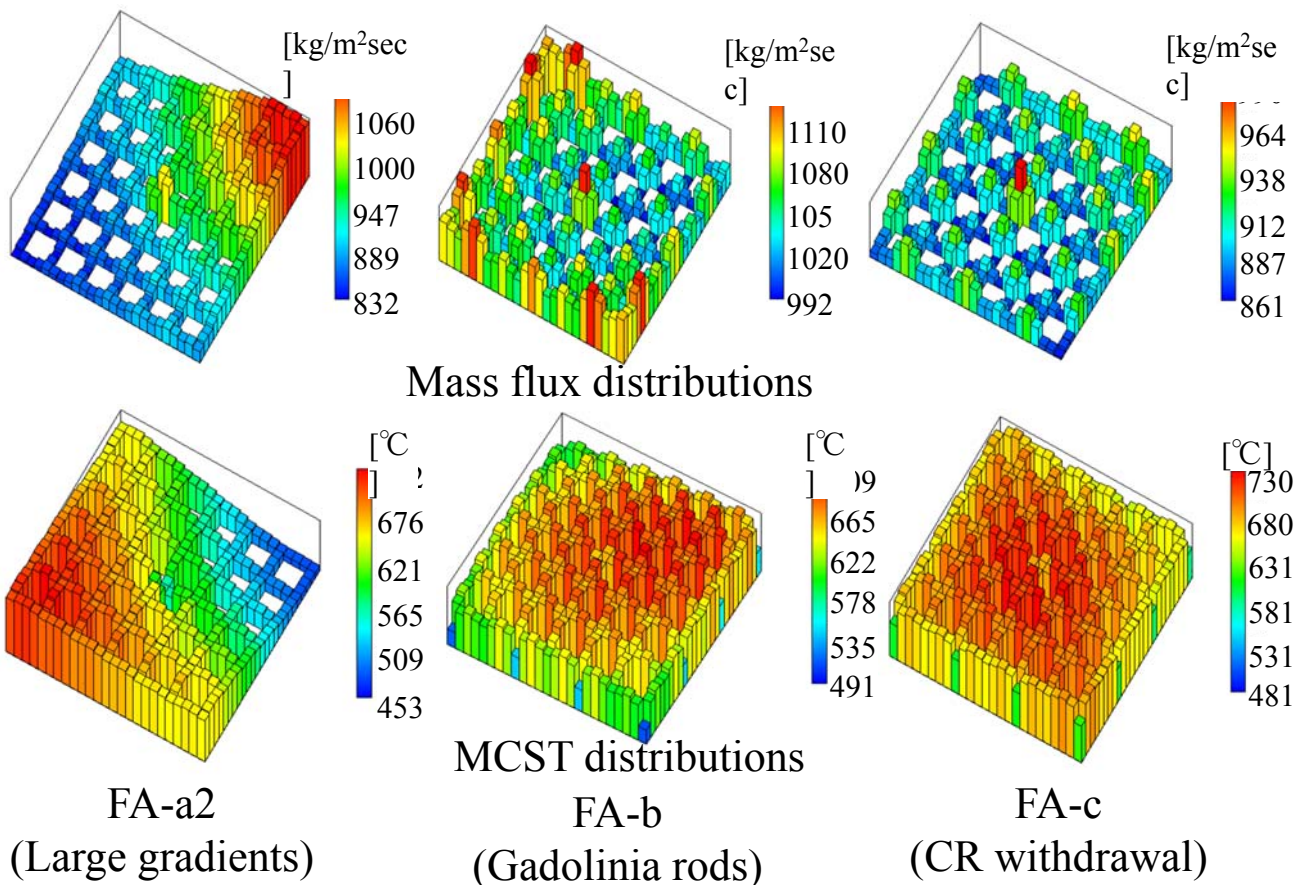

Q4: What is the effect of design uncertainty and engineering uncertainty on the peak cladding temperature?

A4 : Statistical thermal design

- Taking uncertainties into evaluation of peak cladding temperature

Methods to evaluate the engineering uncertainty

➤ Classification:

(1) The direct method:

All uncertainties are set at their worst values and occur at the same location and at the same time.

Traditional and conservative.

(2) The traditional way by using hot spot and hot channel factors:

(a) The deterministic method by using factors.

(b) The statistical method by using factors.

(c) The semi-statistical method:

Two groups of uncertainties: direct and statistical factors.

The factors are evaluated separately and combined statistically.

(3) The statistical thermal design method:

System parameters uncertainties are combined statistically.

Uncertainties of nuclear hot factors are considered statistically.

Engineering hot spot factors are used in a statistical way.

Statistical characteristics of MCST distributions

Case 1: system parameters are sampled as normal distributions

Case 2: system parameters are sampled as uniform distributions

MCST (°C)		Case 1	Case 2
BOC	Mean value	651.64	651.63
	Standard deviation	14.91	17.81
	Maximum value	702.88	710.38
MOC	Mean value	649.65	650.51
	Standard deviation	15.54	18.32
	Maximum value	696.43	708.70
EOC	Mean value	649.73	650.91
	Standard deviation	12.01	14.51
	Maximum value	700.96	693.26
Maximum standard deviation		15.54	18.32
σ_{PF}		18.32	

Thermal margin for engineering uncertainty

Standard deviation of system parameter uncertainty
and hot factor uncertainty

$$\sigma_{PF} = 18.32^{\circ}\text{C}$$

Standard deviation of correlation uncertainty

$$\sigma_C = 6.33^{\circ}\text{C}$$

Engineering uncertainty:

$$1.645\sqrt{\sigma_{PF}^2 + \sigma_C^2} = 31.88^{\circ}\text{C}$$

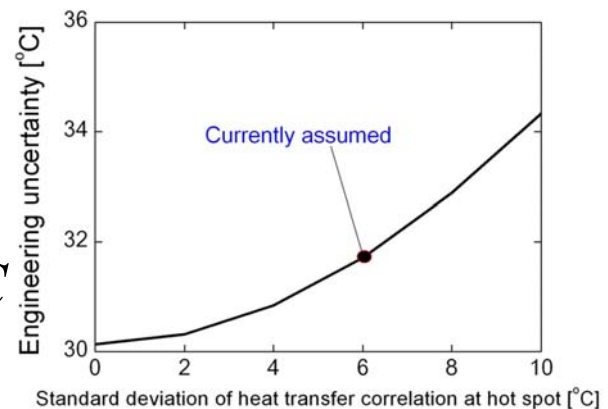

Peak Cladding Surface Temperature

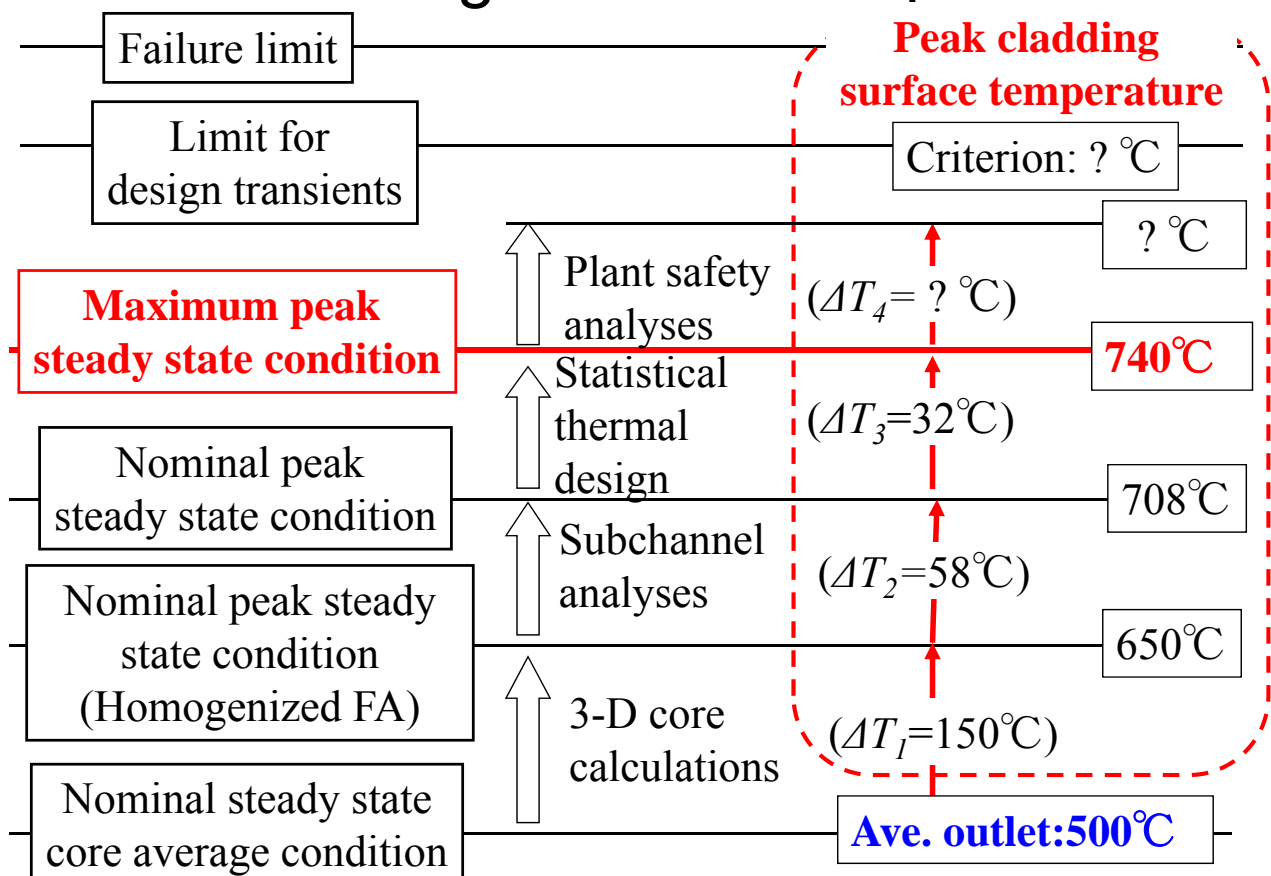

Plant control

Plant start-up

Stability

Safety

Q10: What is the fundamental safety requirement / monitoring parameter for safety of LWR

A10: Keep coolant inventory / water level

No water level at supercritical-pressure

Q11: What is the fundamental safety requirement / monitoring parameter of super LWR (SCWR)

A11: Keep core flow rate / monitor coolant flow rate

Safety principle of Super LWR

- Keeping coolant inventory is not suitable due to no water level and large density change.
- Coolant inventory is not important due to no circulation.
- No natural circulation

Safety principle is keeping **core coolant flow rate**.

Coolant supply (main coolant flow rate)

Coolant outlet (pressure)

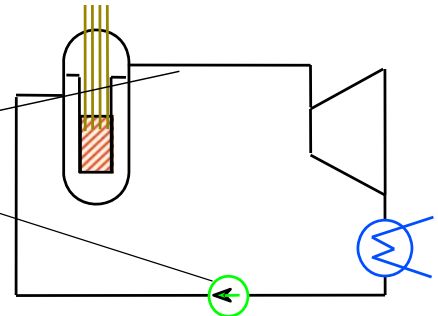

	BWR	PWR	Super LWR
Requirement	RPV inventory	PCS inventory	Core flow rate
Monitoring	RPV water level	Pressurizer water level	Main coolant flow rate, Pressure

Plant and safety system

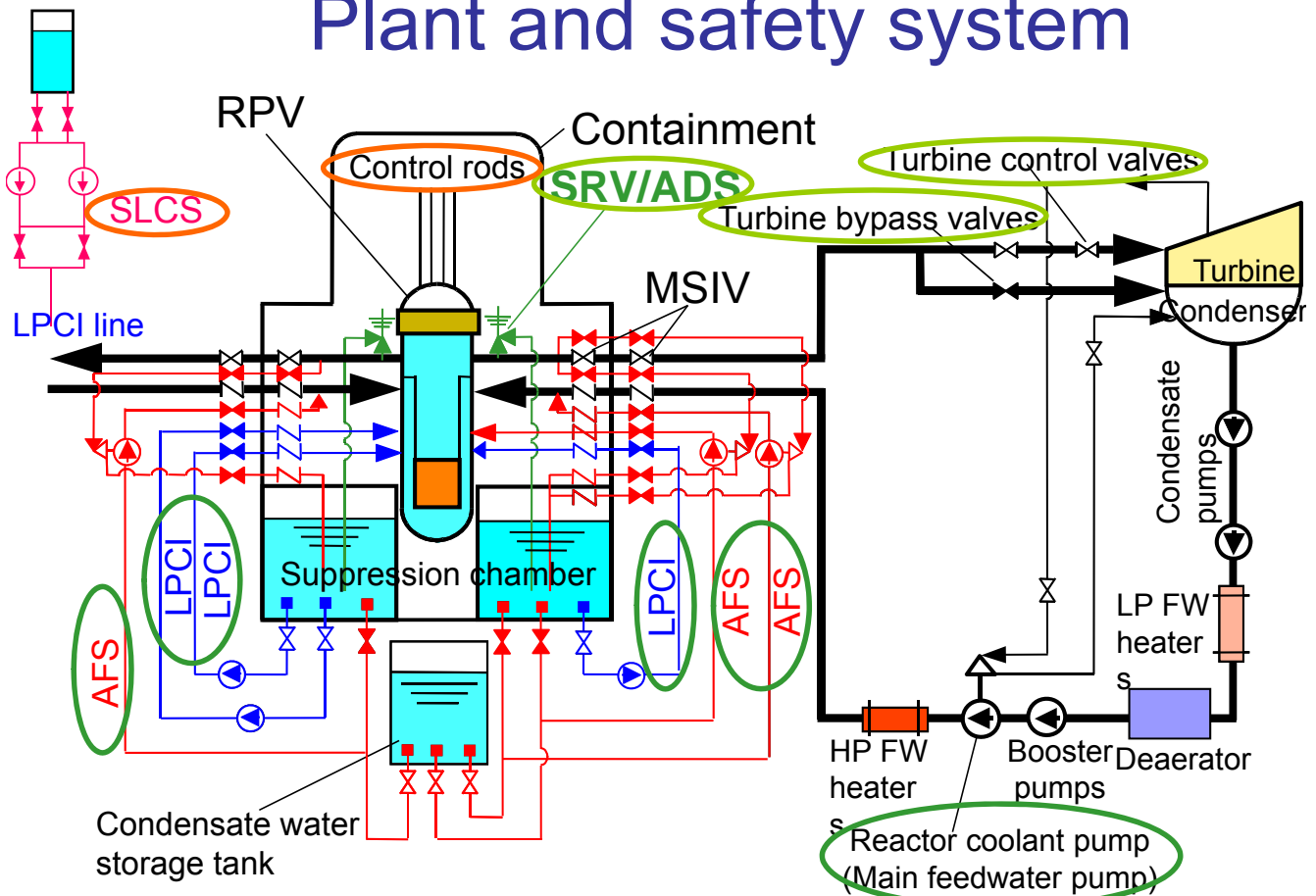

Abnormal levels and actuations

Flow rate low (\Leftrightarrow Coolant flow from cold-leg)

Level 1 (90%)* Reactor scram

Level 2 (20%)* AFS

Level 3 (6%)* ADS/LPCI

Pressure high (\Leftrightarrow Coolant outlet at hot-leg)

Level 1 (26.0 MPa) Reactor scram

Level 2 (26.2 MPa) SRV

Pressure low (\Leftrightarrow Valve opening, LOCA)

Level 1 (24.0 MPa) Reactor scram

Level 2 (23.5 MPa) ADS/LPCI

*100% corresponds rated flow rate

Q12 : How to determine the LPCI capacity?

A12: Period of filling reactor pressure vessel and LOCA heat up analysis

Safety system design

Capacity:

AFS

TD 3 units: 50kg/s/unit (4%)* at 25MPa

LPCI/RHR

MD 3 units: 300kg/s/unit (25%)* at 1MPa

SRV/ADS

8 units: 240kg/s/unit (20%)* at 25MPa

Configuration:

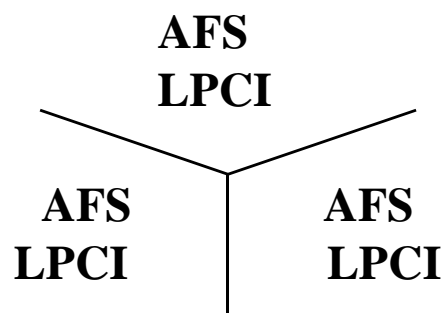

*100% corresponds to rated flow rate

Principle for fuel rod integrity

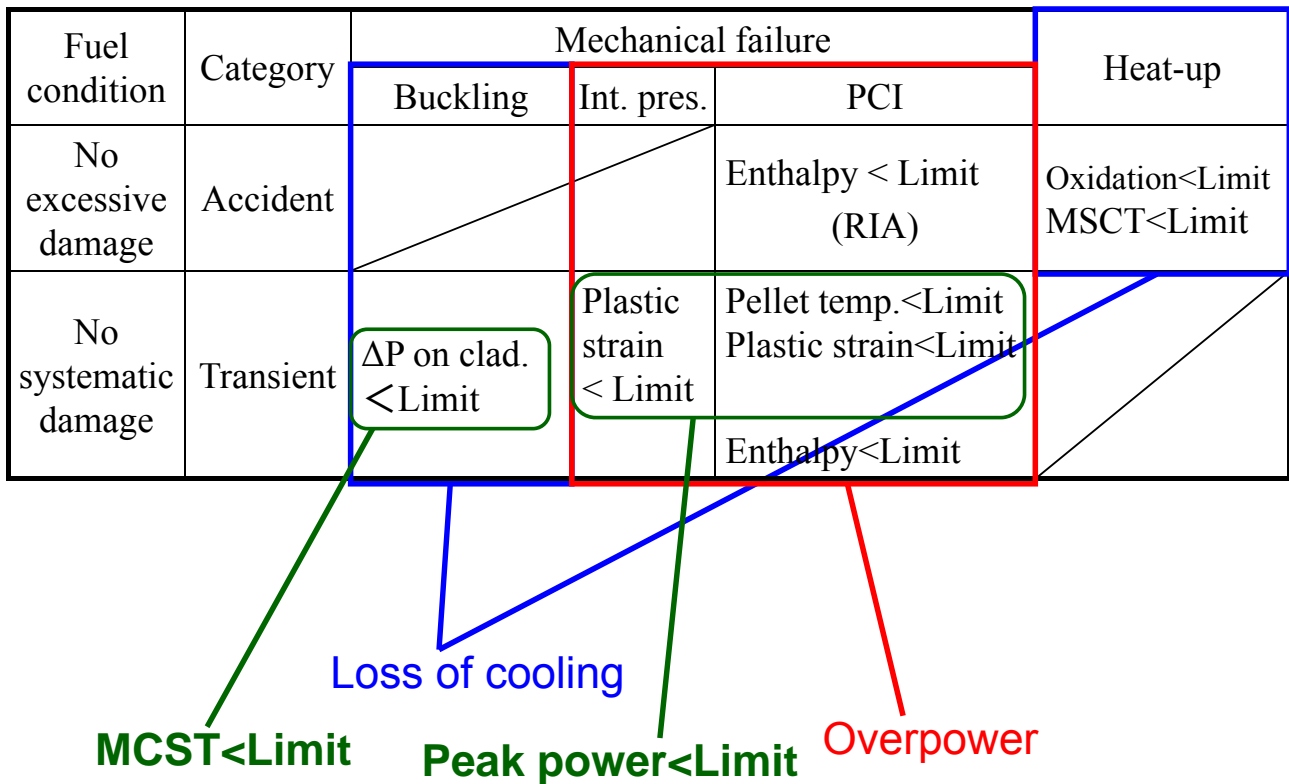

Initial condition and criteria for MCST

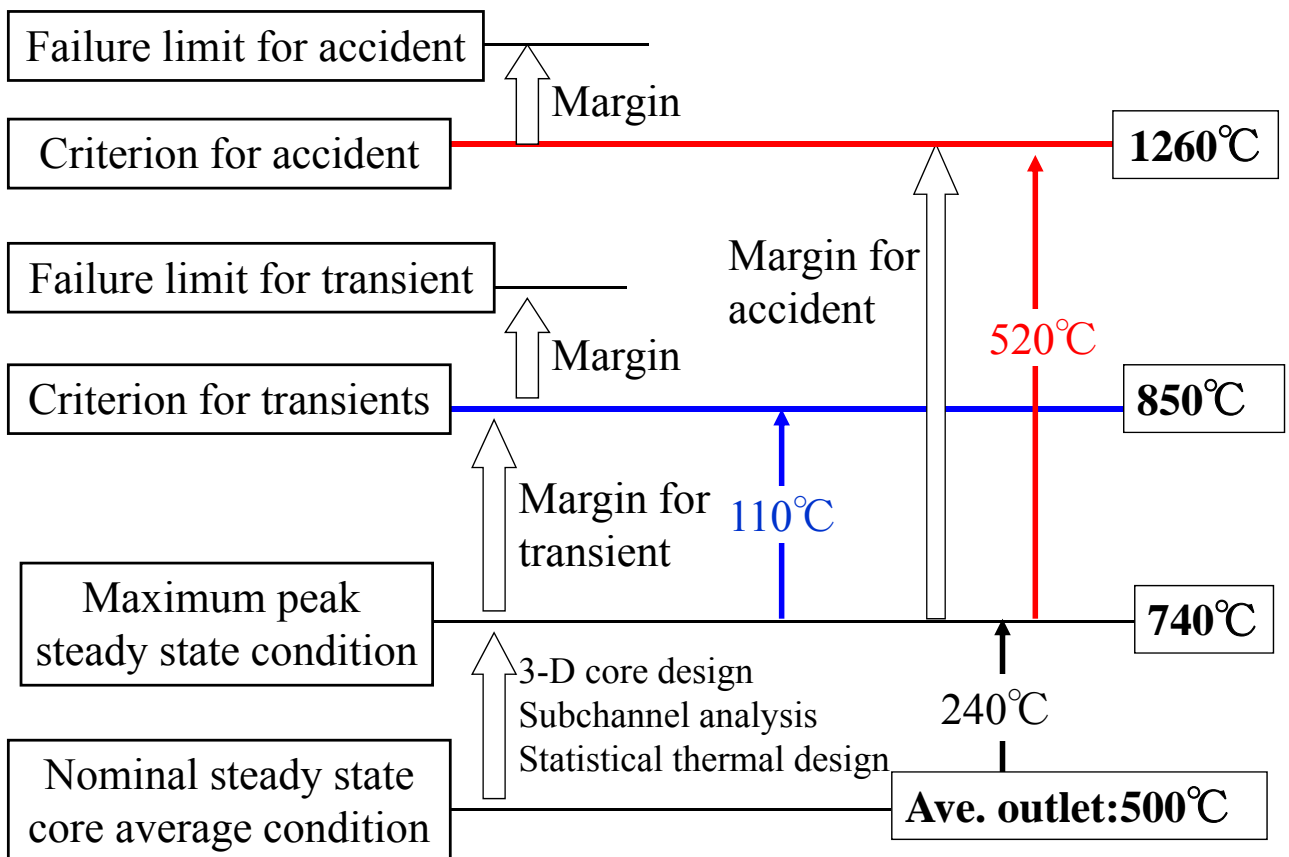

Initiating events for safety analyses

Type of abnormality	Transients
Decrease in core coolant flow rate	1. Partial loss of reactor coolant flow 2. Loss of offsite power
Abnormality in reactor pressure	3. Loss of turbine load 4. Isolation of main steam line 5. Pressure control system failure
Abnormality in reactivity	6. Loss of feedwater heating 7. Inadvertent startup of AFS 8. Reactor coolant flow control system failure 9. Uncontrolled CR withdrawal at normal operation 10. Uncontrolled CR withdrawal at startup
Type of abnormality	Accidents
Decrease in core coolant flow rate	1. Total loss of reactor coolant flow 2. Reactor coolant pump seizure
Abnormality in reactivity	3. CR ejection at full power 4. CR ejection at hot standby
LOCA	5. Large LOCA 6. Small LOCA

Analysis code for supercritical-pressure

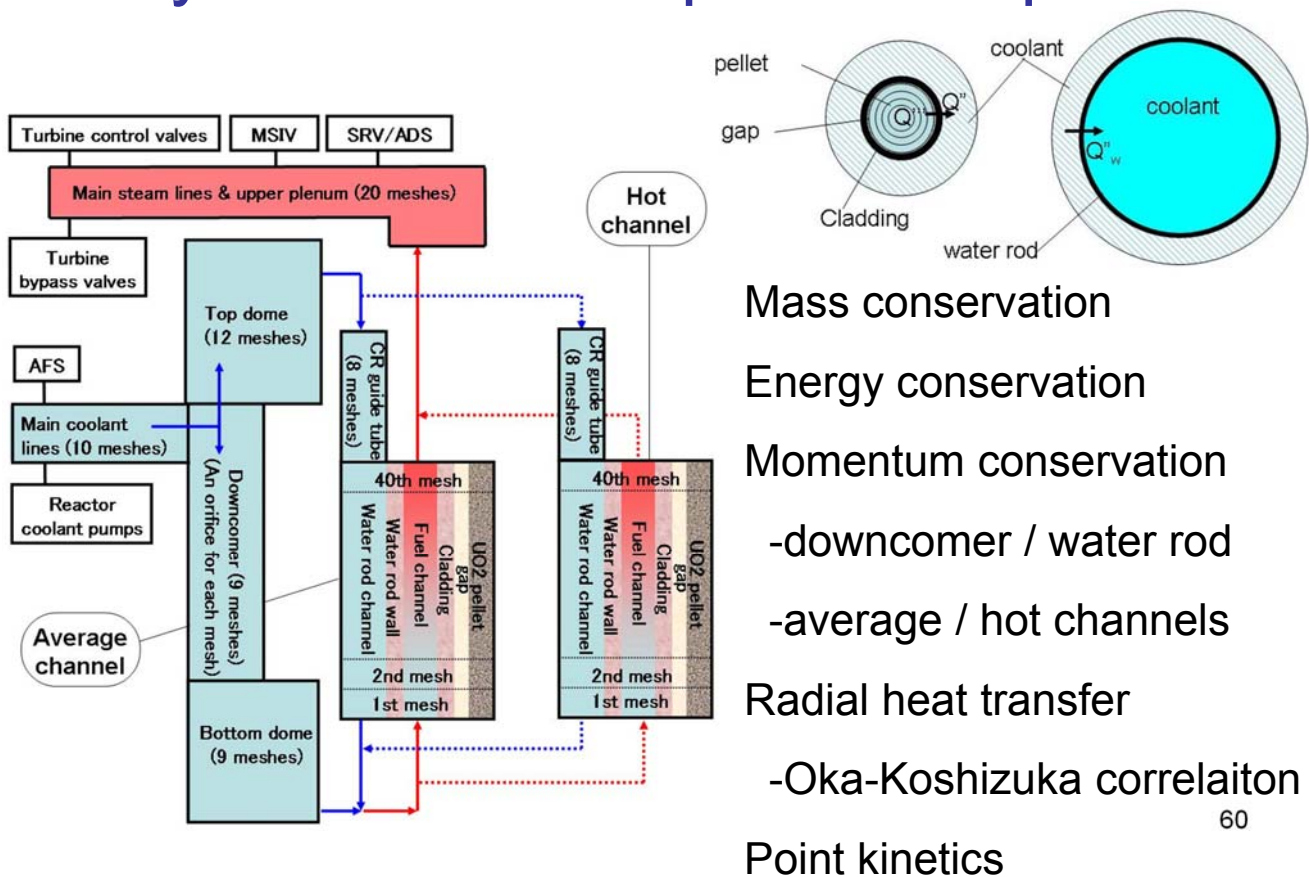

Depressurization induces core coolant flow of the once-through cycle reactor

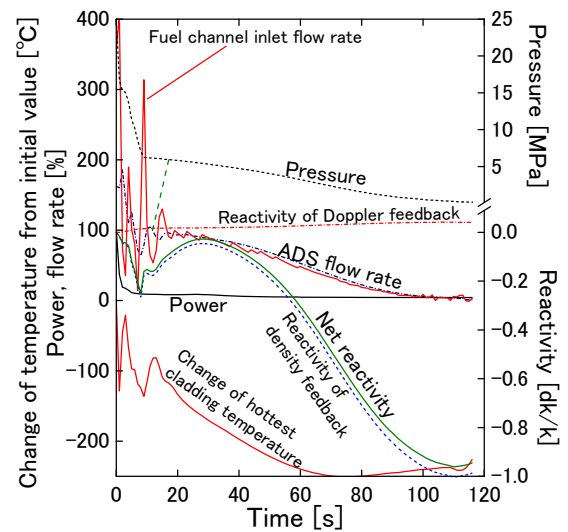
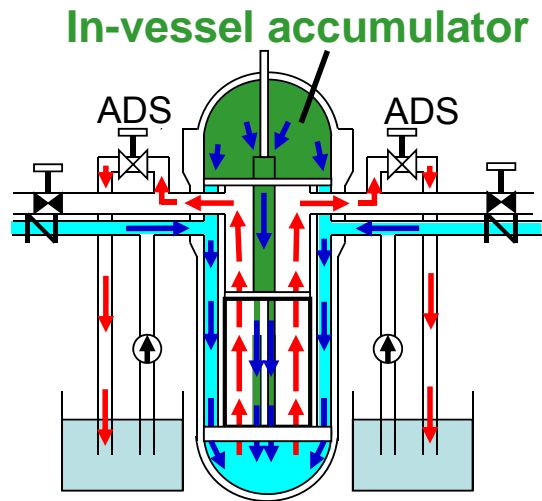

Once-through system \Rightarrow Coolant flow induced in the core
 Large water inventory of Top dome \Rightarrow **In-vessel accumulator**
 Negative void reactivity \Rightarrow Power decreasing

Water rods mitigate loss-of-flow events.

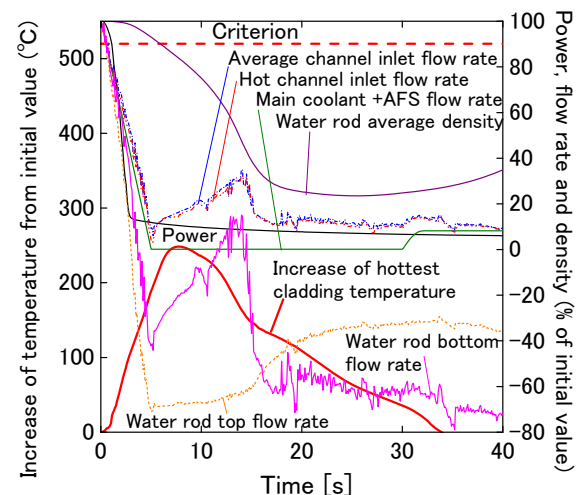
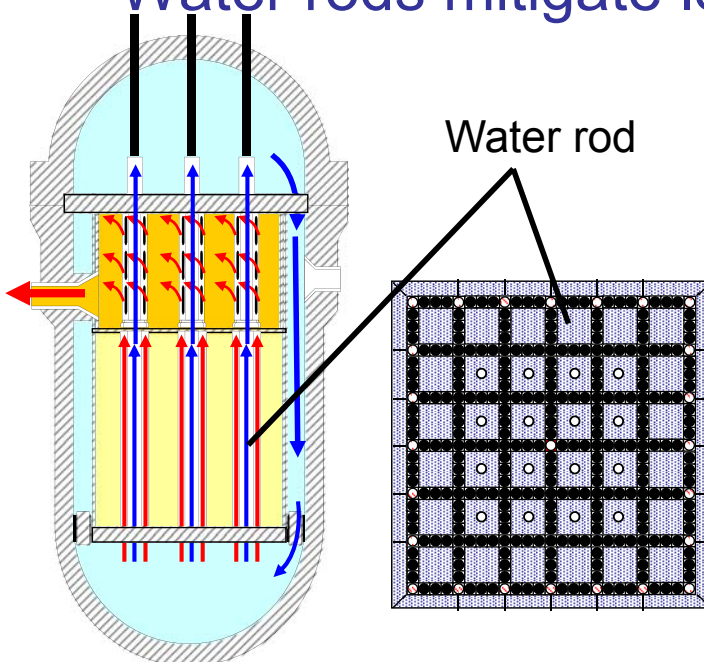

Total loss of reactor coolant flow

$$\Delta MCST \approx 250^\circ\text{C}$$

Under loss-of-flow condition:

Heat conduction to water rods increases. \rightarrow **“Heat sink”** effect

Water rods supply their inventory to fuel channels due to thermal expansion. \rightarrow **“Water source”** effect

Alternative action is not necessary under ATWS conditions (Super LWR)

Analysis results for ATWS events without an alternative action

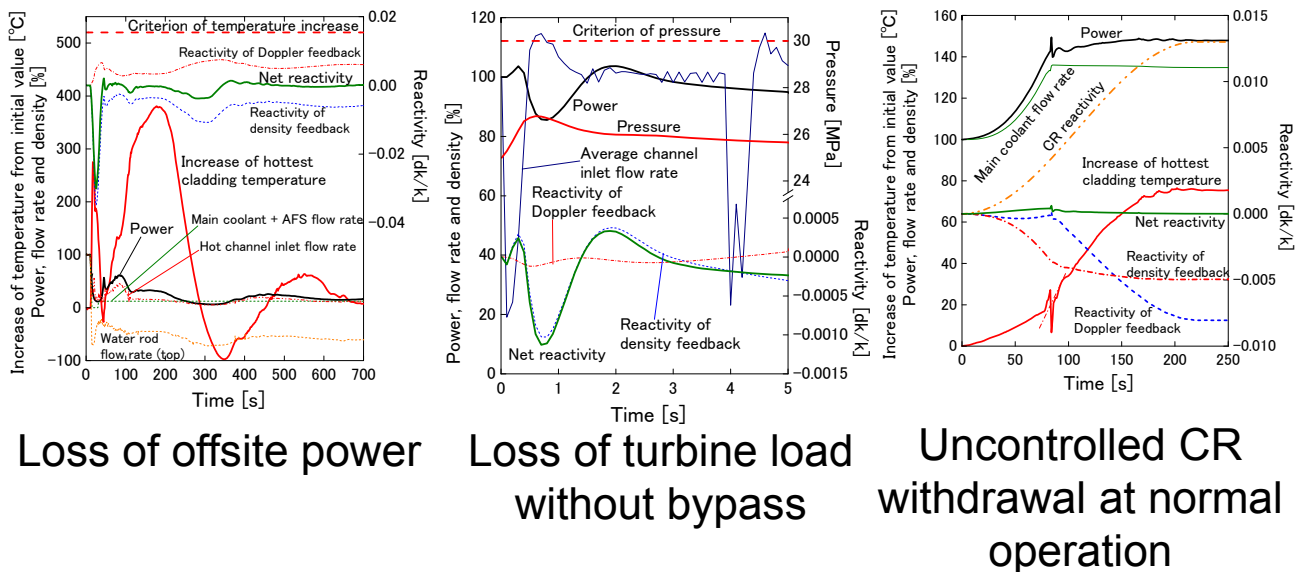

Good inherent safety characteristics of Super LWR

Why ATWS is mild?

1. **Small** power increase by valve closure.
 - **flow stagnation** mitigates density increase
 - **no void collapse**
 2. Power decreases with core flow rate due to density feedback.
- Good ATWS behavior without alternative action inserting negative reactivity

Summary of safety analysis results

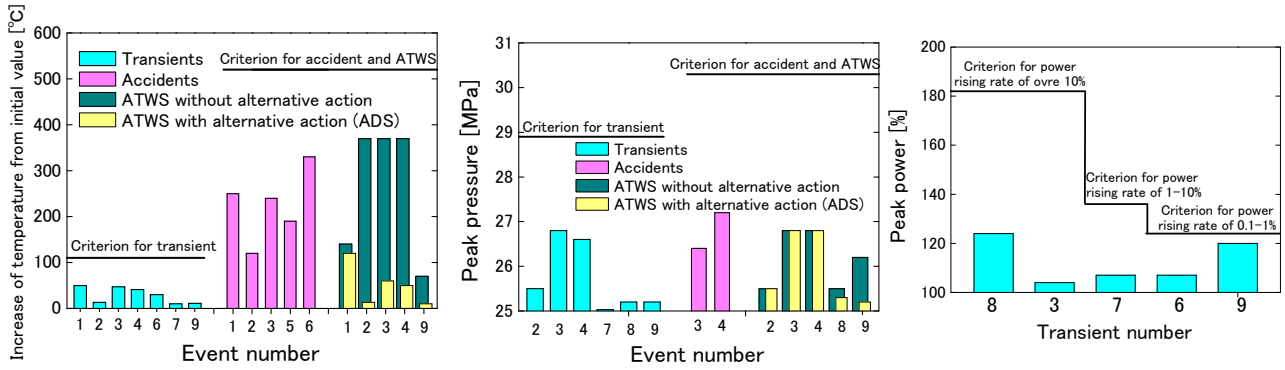

Transients	Accidents
<ol style="list-style-type: none"> 1. Partial loss of reactor coolant flow 2. Loss of offsite power 3. Loss of turbine load 4. Isolation of main steam line 5. Pressure control system failure 6. Loss of feedwater heating 7. Inadvertent startup of AFS 8. Reactor coolant flow control system failure 9. Uncontrolled CR withdrawal at normal operation 10. Uncontrolled CR withdrawal at startup 	<ol style="list-style-type: none"> 1. Total loss of reactor coolant flow 2. Reactor coolant pump seizure 3. CR ejection at full power 4. CR ejection at hot standby 5. Large LOCA 6. Small LOCA

Δ MSCT for abnormal events

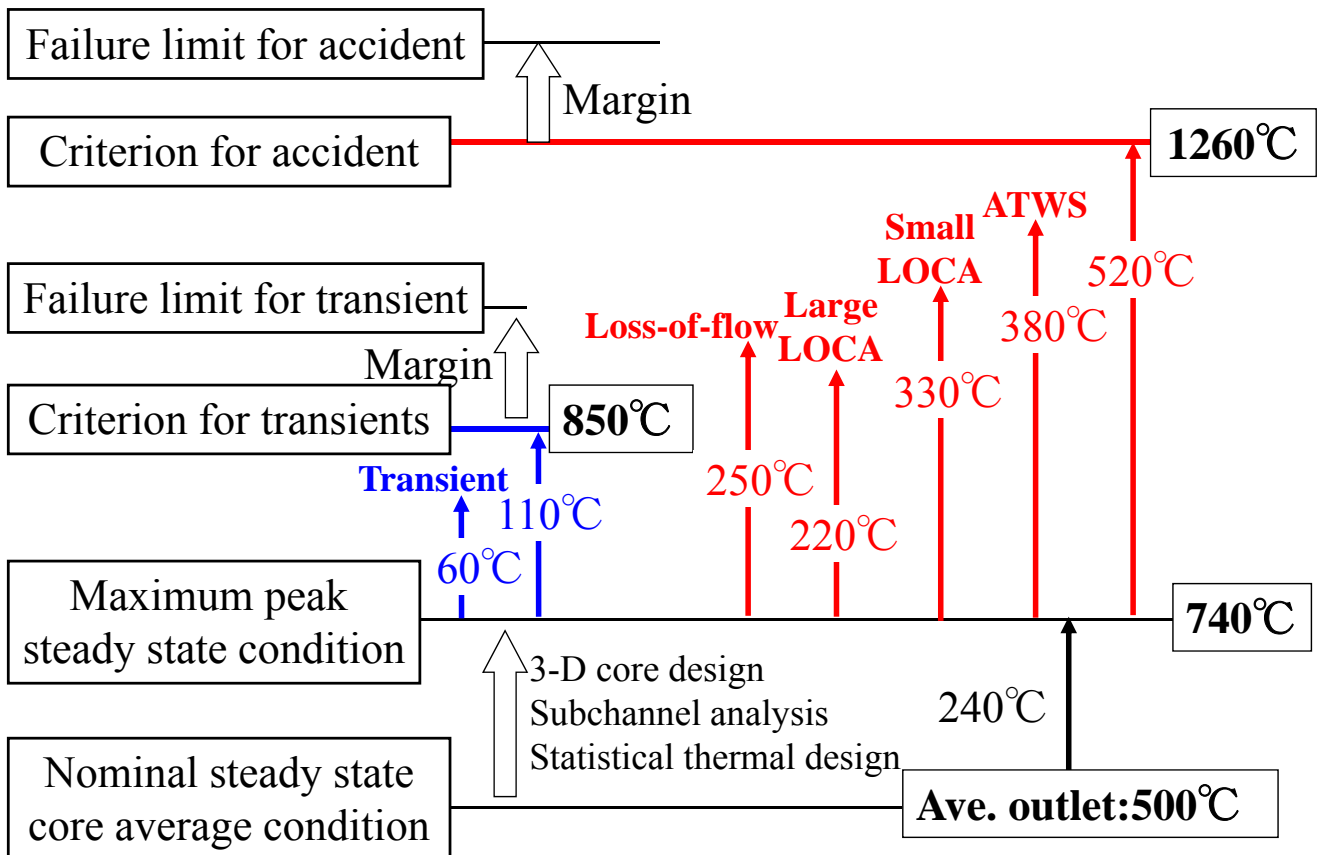

Summary of safety characteristics of Super LWR

67

- Core cooling by depressurization
- Top dome and water rods serve as an “in-vessel accumulator”
- Loss of flow mitigated by water rods
- Short period of high cladding temperature at transients
- Mild behavior at transients, accidents and ATWS
- Simple safety principle (keeping flow rate) due to once-through cooling cycle

68

Q13 : How to determine containment vessel (CV) volume?

A13 : Coolant enthalpy inside and design pressure of CV

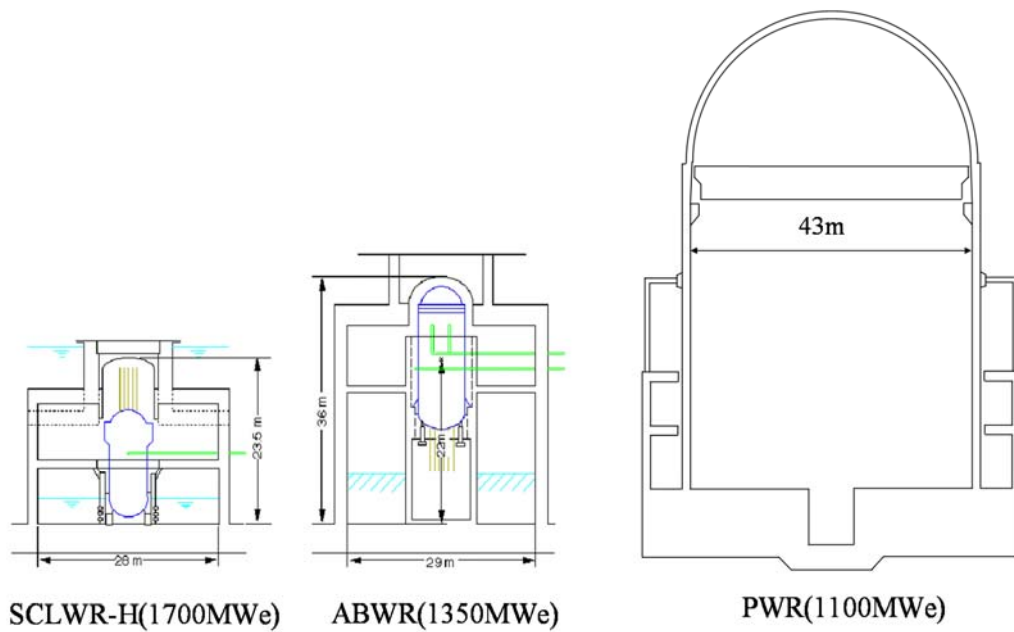

Comparison of containments

Economic potential

Improvement of 1700MWe Super LWR from 1350MWe ABWR

	SCLWR-H	ABWR	improvement in %
Thermal efficiency, %	44.0	34.5	28%
RPV weight, t	750	910	18%
CV volume, m3	7900	17000	54%
Steam line number	2	4	50%
Turbine speed, rpm	3000*	1500*	50%
Condenser	2	3	33%

*3600rpm and 1800rpm in the western Japan

Advantages

1. Experience in LWR and fossil fuel power plant technologies.
2. Major components are within the temperature experience
3. Single phase flow ; easy to analyze.
4. Compatible with tight lattice fast reactor core
5. Good subject for reactor knowledge transfer to young generation: LWR design, analysis and safety

Scope of studies and Computer codes

1. Fuel and core

Single channel thermal hydraulics (SPROD), 3D coupled core neutronic/thermal-hydraulic (SRAC-SPROD), Coupled sub-channel analysis, Statistical thermal design method, Fuel rod behavior (FEMAXI-6), Data base of heat transfer coefficients of supercritical water

2. Plant system; Plant heat balance and thermal efficiency
3. Plant control
4. Safety; Transient and accident analysis at supercritical- and subcritical pressure, ATWS analysis, LOCA analysis (SCRELA)
5. Start-up (sliding-pressure and constant-pressure)
6. Stability (TH and core stabilities at supercritical and subcritical-pressure)
7. Probabilistic safety assessment

Super Fast Reactor

Purpose of R&D

1. Development of Super FR concept
2. Experiments for developing fundamental database for Super FR as well as Super LWR:
 - Thermal hydraulics
 - Materials (SS cladding and Ytria stabilized zirconia)
 - Corrosion products behaviors

Super fast reactor

Tight fuel lattice

Supercritical-pressure light water cooled fast reactor

Same plant system as Super LWR

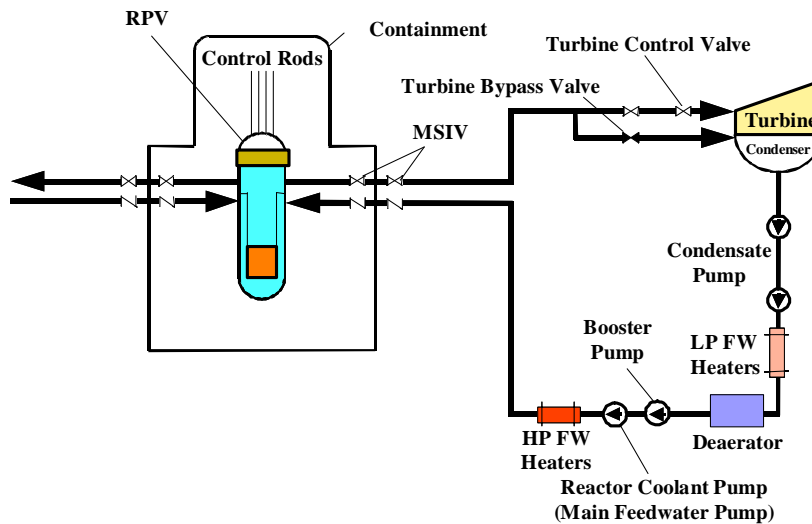

Plant system of Super LWR and Super FR

Advantages of Super Fast Reactor

Low reactor coolant flow rate due to high enthalpy rise

High head pumps of the once-through direct cycle plant

- Compatible with tight fuel lattice core of Super FR, a light water cooled fast reactor
- No pumping power increase and instability problems of high conversion LWR

Same plant system as Super LWR, the thermal reactor

Fast reactors have higher power densities than thermal reactors due to no moderator necessary.

- Making capital cost of Super FR lower than LWRs
(Capital cost; Super FR < Super LWR < LWRs)

Super Fast Reactor R&D (1st Phase) ⁷⁹

Dec. 2005-March 2010

University of Tokyo, JAEA, Kyusyu Univ. and TEPCO
entrusted by MEXT

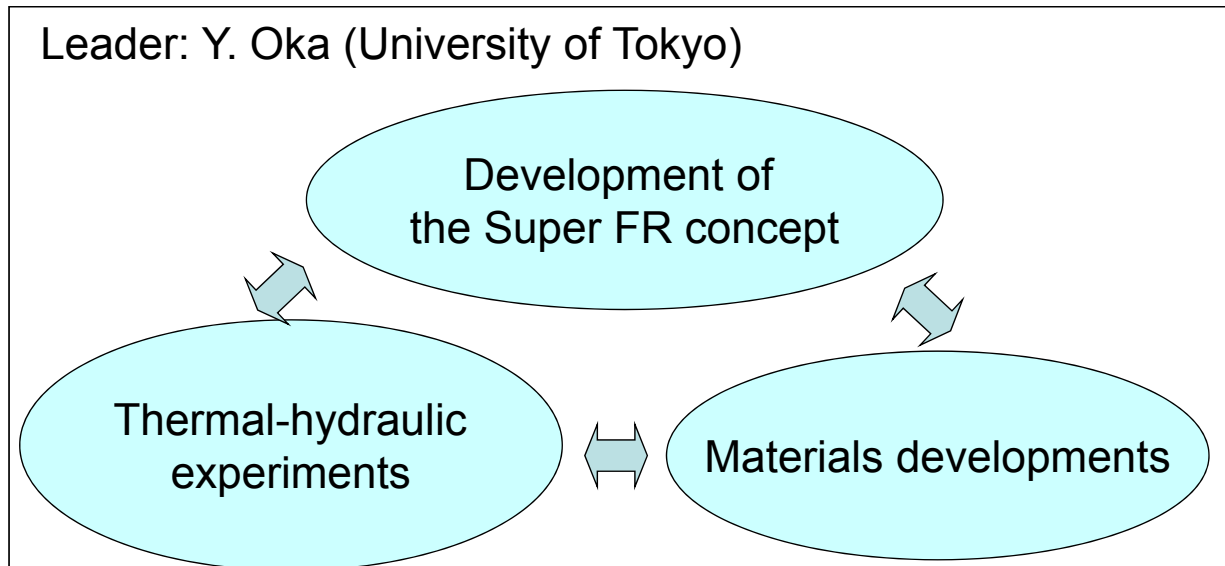

Development of Super FR concept ⁸⁰

first phase project in 2005-March 2010

1. Core design

2. Safety analysis

3. High temperature structural design

4. CFD analysis of tight fuel bundle

5. ACE-3D code development

6. Stability

7. Transmutation analysis from back end risk

8. Computational methods development

Evaluation of accuracy of the transmutation calculation

MPS method for the analysis of condensation of a steam bubble

Fuel and Core (example)

- MOX fuel with SS cladding (Fuel rod analysis)
- Core design: 3-D N-TH coupled core burn-up calculation, subchannel analysis

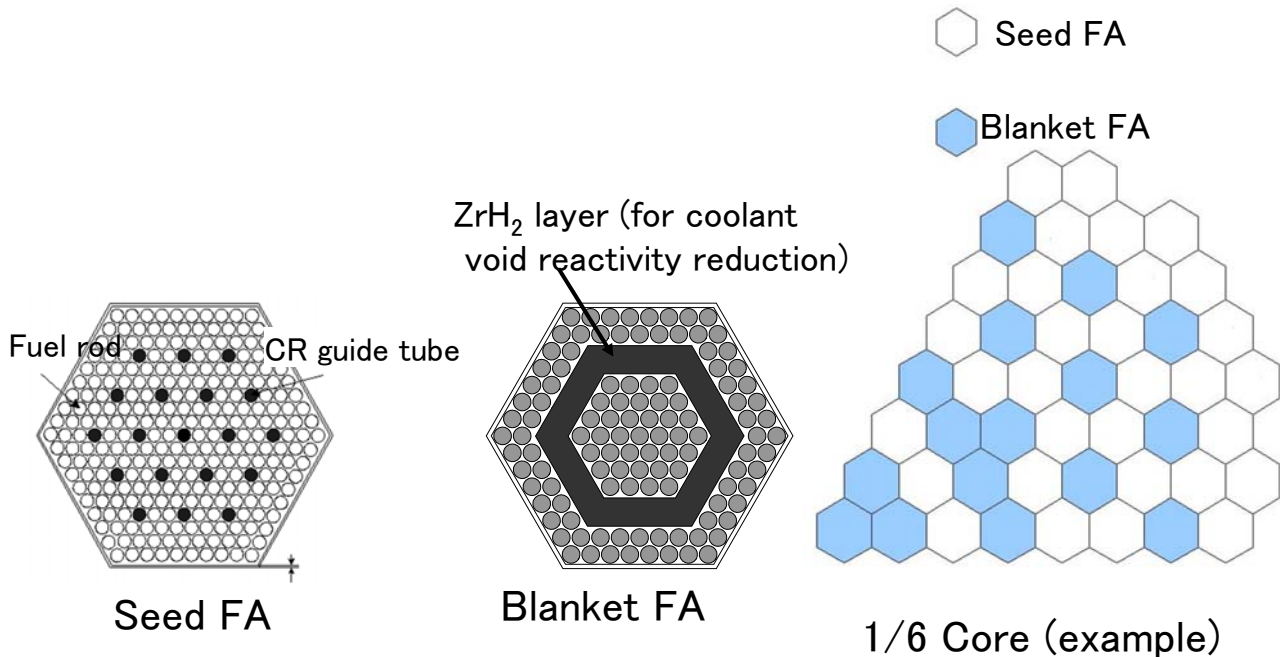

Core Structure and Plant Control and Safety

Core characteristics (700MWe)

	Core1	Core 2
Fuel		
Fuel (Seed/Blanket)	MOX/dep.UO ₂	
Fuel pellet density	95%TD	
Rod OD[mm]	7.0	5.5
Pitch/ OD	1.16	1.19
Cladding Material	SUS304	
Thickness [mm]	0.43	0.4
Effective heating length [cm]	300	200
Core		
No. of seed fuel assemblies	126	162
No. of blanket fuel assemblies	73	
Pitch of FA	14.2	11.6

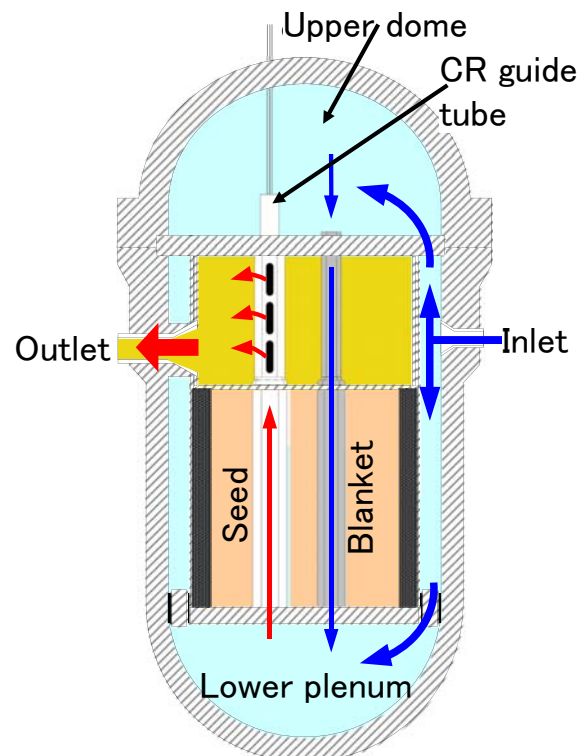

RPV and the coolant flow

Core Design of Super FR

Comparison of characteristics with BWR and PWR

	Super FR	ABWR	PWR
Reactor coolant system	Once-through cycle	Direct cycle with recirculation flow	Indirect cycle
Electrical output [MWe]	700	1,356	890
Thermal efficiency [%]	44	34.5	33.4
Core pressure [MPa]	25	7.2	15.4
Average power density [W/cm ³]	295	50.6	約100
Inlet/Outlet coolant temperature [°C]	280/508	216/287	284/321
Flow rate [t/s]	0.821	14.5	12.7
Flow rate per electrical output [kg/s/MWe]	1.17	10.7	14.3

Comparison of containment vessel of Super FR and PWR

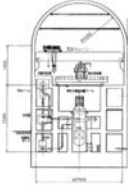
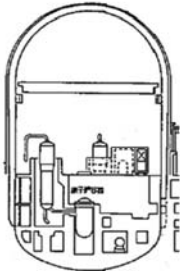
	Super FR (700 MWe)	2 Loop PWR
Cross section		
I. D.	27m	40m
Height	49m	77m
Volume	22,500m ³	67,900m ³
Footprint* 1	4,300m ²	11,300m ²
Components in PCV	<ul style="list-style-type: none"> ▪ RPV and relevant comp. ▪ Startup system ▪ SRV condensation tank 	<ul style="list-style-type: none"> ▪ RPV and relevant comp. ▪ SG ▪ Pressurizer, condensation tank

* 1 Footprint: Nuclear reactor area + turbine area

Safety analysis of Super FR

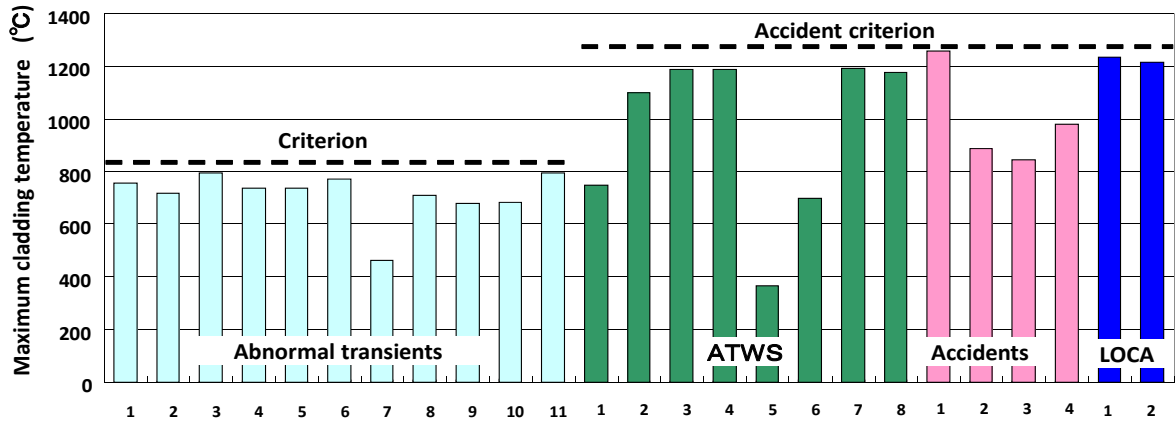

Abnormal transients	
1	Loss of feed water heating
2	Inadvertent startup of auxiliary feed water system
3	Partial Loss of reactor coolant flow
4	Loss of offsite power
5	Loss of turbine load with opening turbine bypass valve
6	Loss of turbine load without opening turbine bypass valve
7	Uncontrolled Control Rod withdrawal at Startup
8	Uncontrolled Control Rod withdrawal at normal operation
9	Reactor coolant flow control system failure
10	Reactor pressure control system failure
11	Isolation of Main steam line

ATWS	
1	Loss of feed water heating
2	Partial loss of reactor coolant flow
3	Loss of offsite power
4	Loss of turbine load without opening TBV
5	Uncontrolled CR withdrawal at Startup
6	Uncontrolled CR withdrawal at normal operation
7	Reactor coolant flow control system failure
8	Isolation of Main steam line

Accidents	
1	Total loss of reactor coolant flow
2	Reactor coolant pump seizure
3	CR ejection at full power
4	CR ejection at hot standby

LOCA	
1	Cold Leg Break LOCA
2	Hot Leg Break LOCA

High temperature structural design Reactor pressure vessel

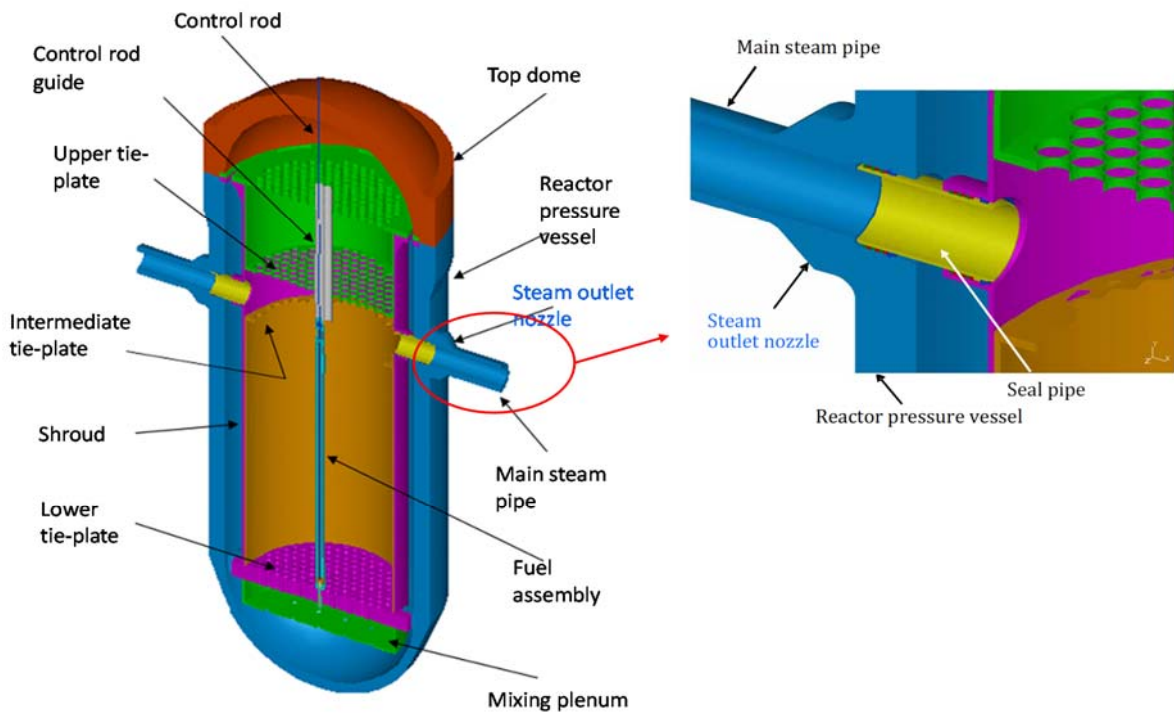

Thermal hydraulic experiments

Freon at Kyushu University

1. Single tube experiments
2. 7- rod bundle experiment
3. Critical heat flux experiment at subcritical-pressure
4. Critical flow measurement
5. Condensation experiment

Supercritical water at JAEA

1. Single rod experiments
2. 7- rod bundle experiment

Thermal hydraulic experiments

Kyusyu University ;HCFC22 (Freon)



- (1) single tube and 7-rod bundle
- (2) critical heat flux near critical pressure
- (3) critical flow and condensation

JAEA Naka-lab; Supercritical Water

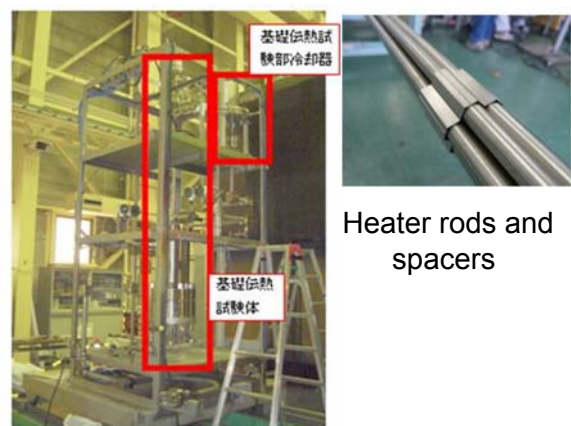

Heater rods and spacers

Single rod and 7-rod bundle

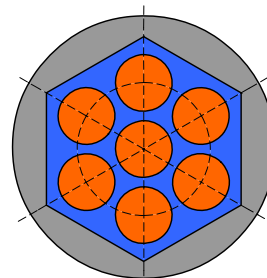

Grid spacer effect on heat transfer coefficients and critical heat flux

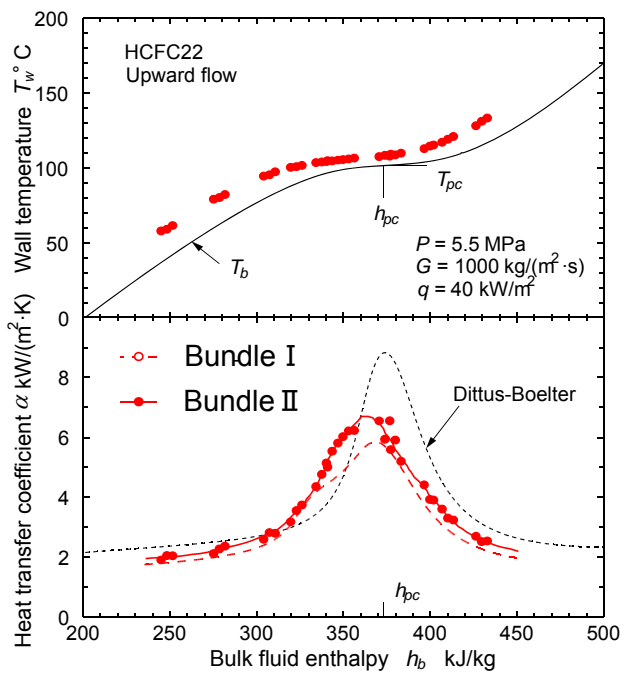

Wall temperature and heat transfer coefficient of 7-rod bundle test

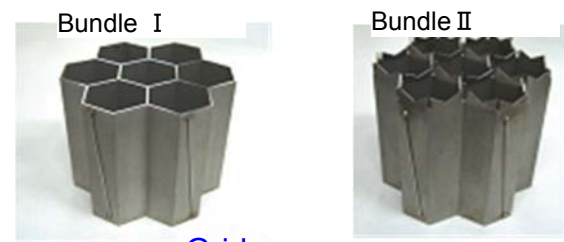

Grid spacers

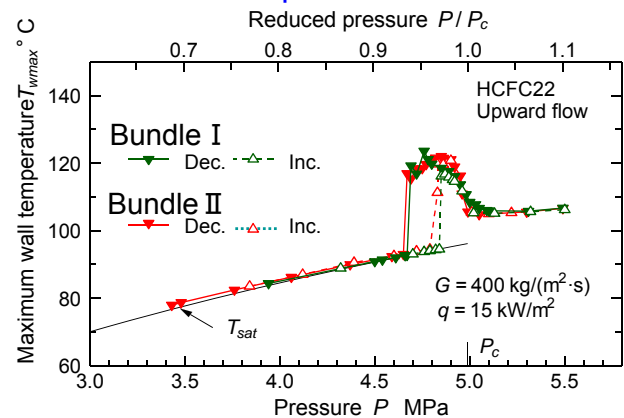

Maximum wall temperature at critical heat flux

Materials development

1. SS cladding for supercritical water cooling
2. Thermal insulation material, YSZ (Yttria stabilized zirconia)
3. Elusion of corrosion products in supercritical water

Need for Developing High Creep Strength Clad

- **Max. stress on clad at peak T (700–750°C): 70–100MPa**
 - Exceed creep strength of SS for LWR (SUS316L)
 - Advanced SS for LMFBR (PNC1520) almost satisfies the requirement but SCC susceptibility, corrosion and neutron absorption properties need to be improved



- **High creep strength clad needs to be developed for Super FR**

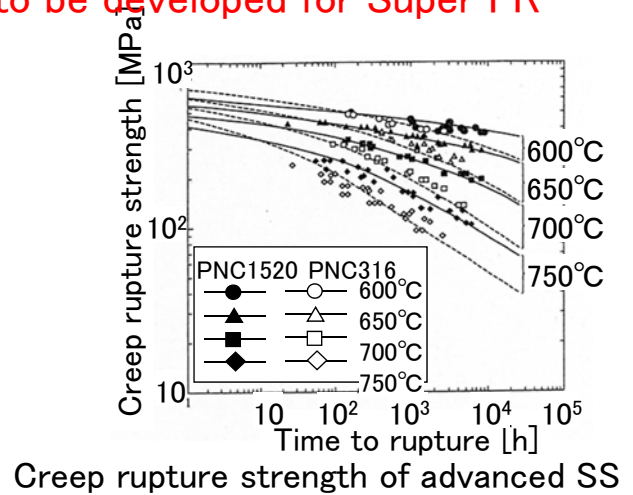
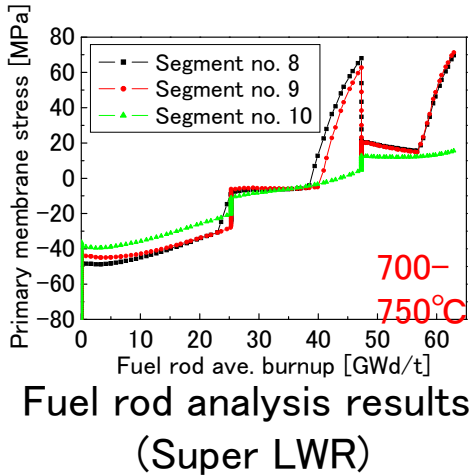

Weight gain and loss of the plate materials before and after the removal of oxidation layer at supercritical water condition (600°C, 25MPa)

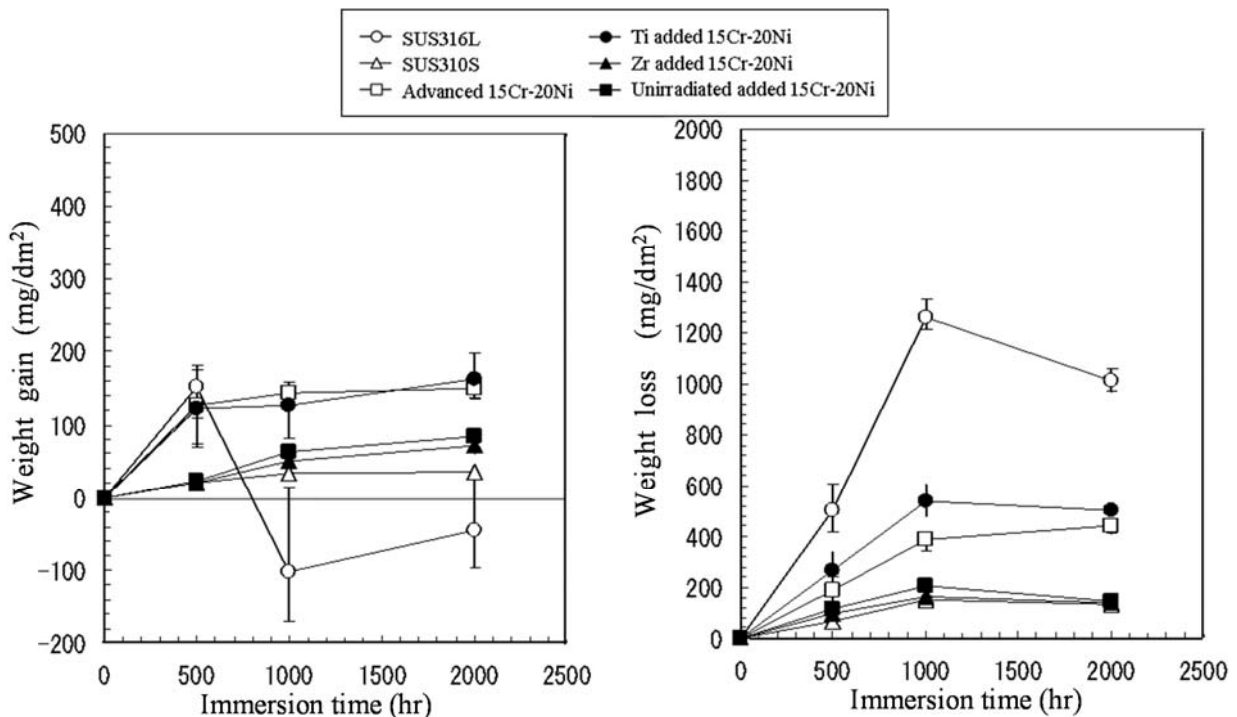

Developed Good Thermal Insulator Yttria stabilized zirconia (YSZ)

- Large ΔT ($\sim 250^\circ\text{C}$)
- Thermal insulator is required for:
 - reduction of thermal stress
 - maintaining coolant temperature

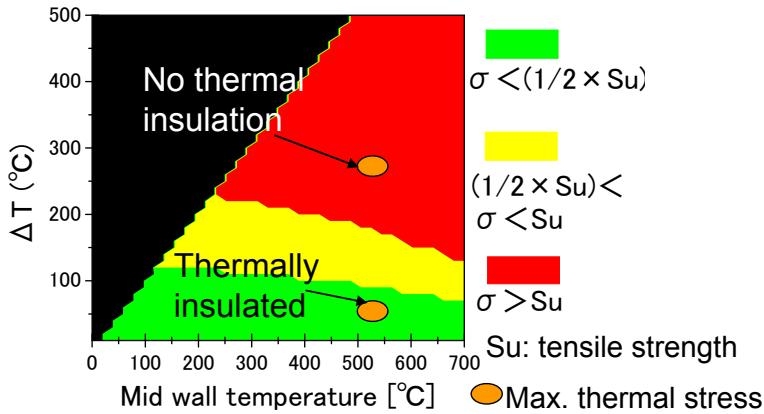
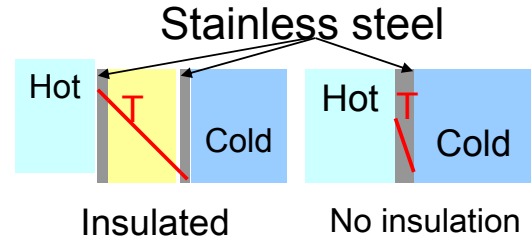

Thermal stress on the wall

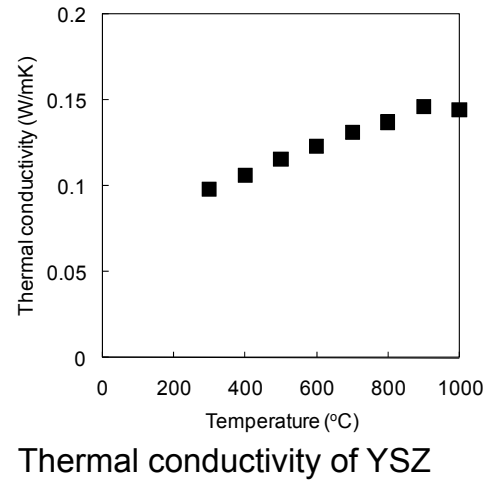

Thermal conductivity of YSZ

Change of thermal conductivity of 8YSZ with the density

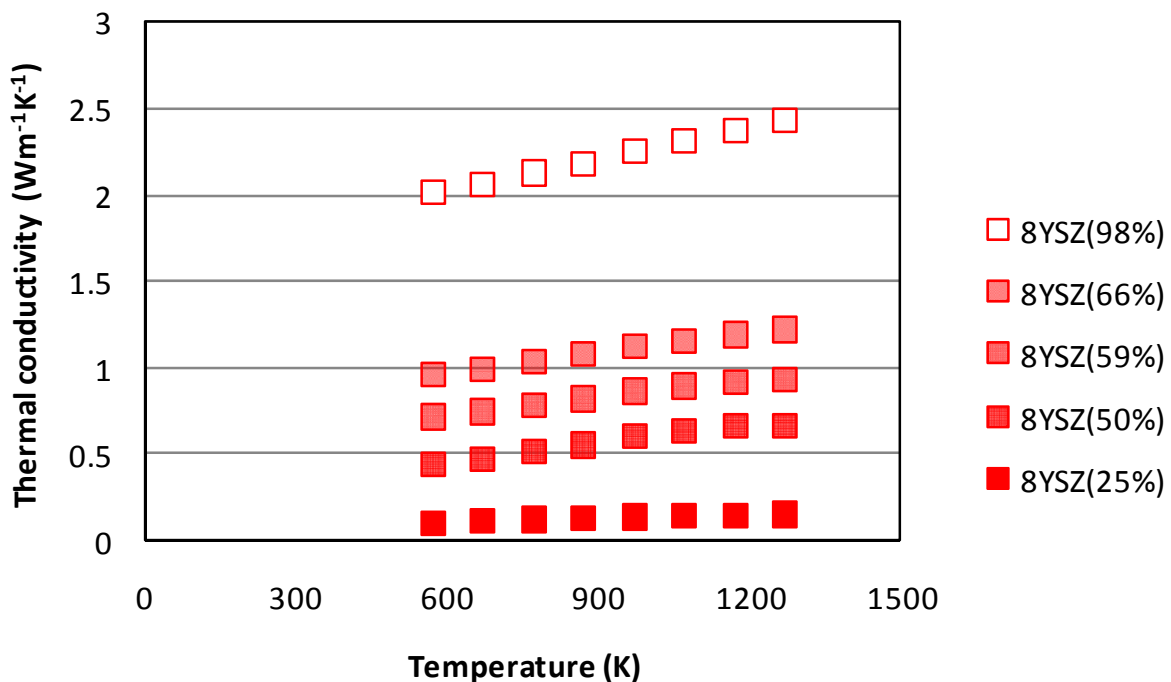

Compressive strength of 8YSZ

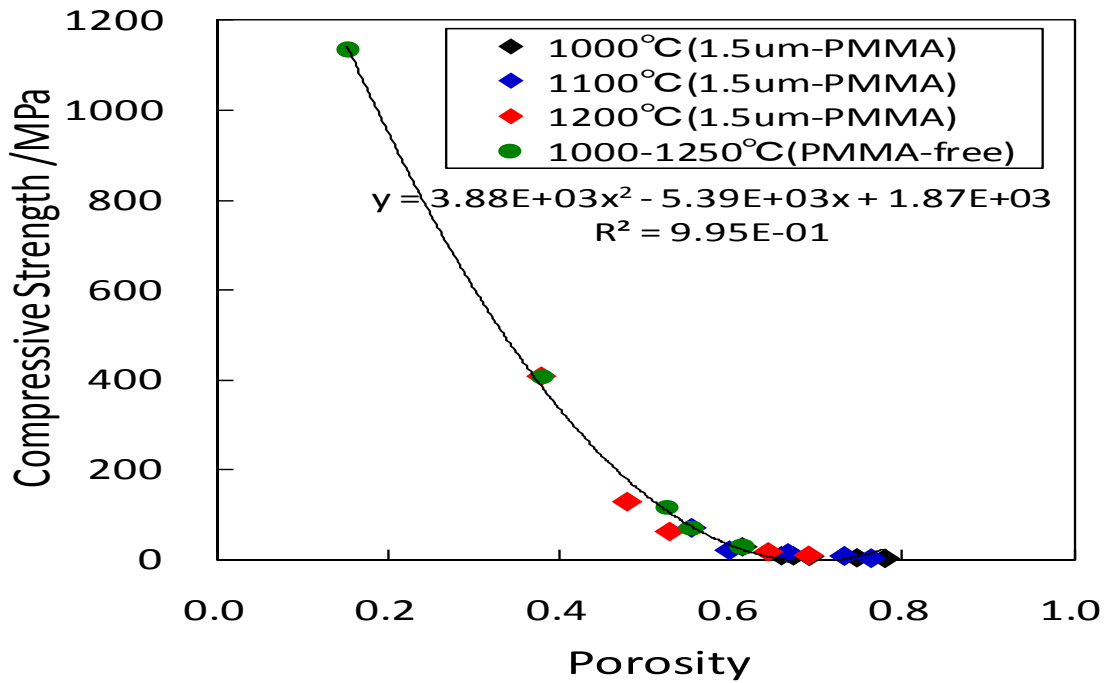

Elution of structural material in SC water



Elution decreases with temperature (at 25 MPa)

	Absolute value (g / m ²)		Relative value (Normalized at 300 °C)	
	Deaerated	200 ppb O ₂	Deaerated	200 ppb O ₂
300 °C	0.203	0.102	1.0	1.0
400 °C	0.0098	0.0085	0.048	0.083
450 °C	0.0045	0.0045	0.022	0.045
550 °C	< 0.002	0.0062	< 0.01	0.060

Elution depends on O₂

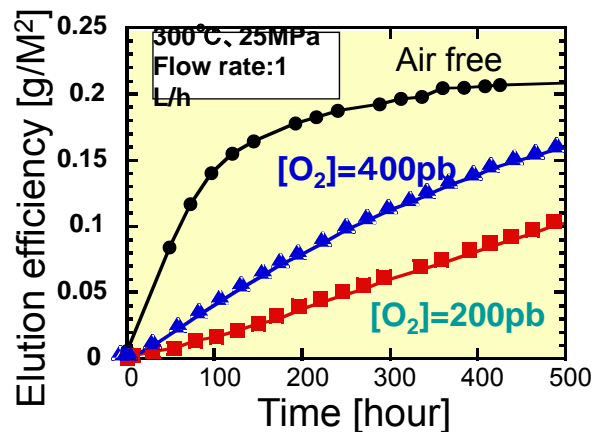

Experimental devices

Change of elution for different oxide layer thickness

97

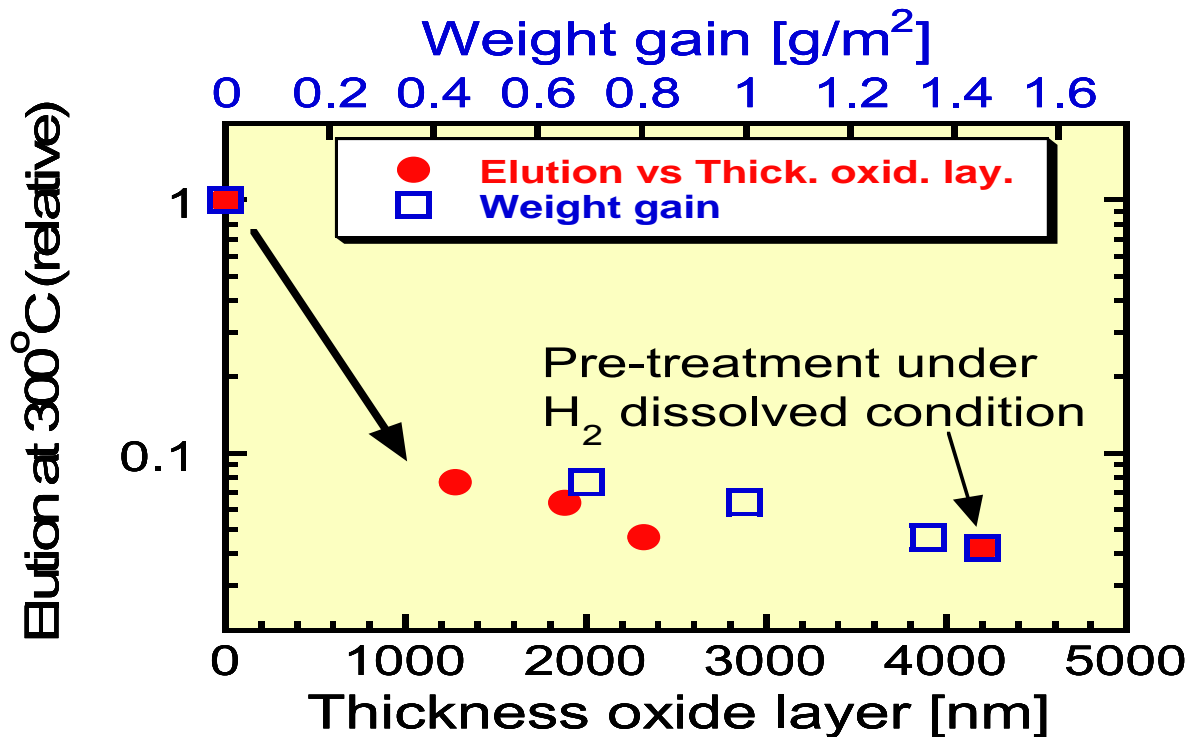

98

Super fast reactor R&D project (2nd phase, July 2010–March 2013) Waseda University

1. Development of the plant concept:

Core design, Safety analyses, Experiment on the reactivity effects of a zirconium hydride layer

2. Thermal-hydraulics:

Freon experiments, Water experiments, CFD simulations

3. Material-coolant interactions:

Experiment on corrosion product transport

Experiment on high temperature oxidation in steam

Super LWR design study started in 1989.

The results (until 2009) are summarized in the monograph.

Also a textbook of reactor design and analysis: Core & fuel design, plant control, start-up, plant heat balance, stability, safety design and analysis of Super LWR and Super FR as well as the computational methods

Published in July 2010 from Springer

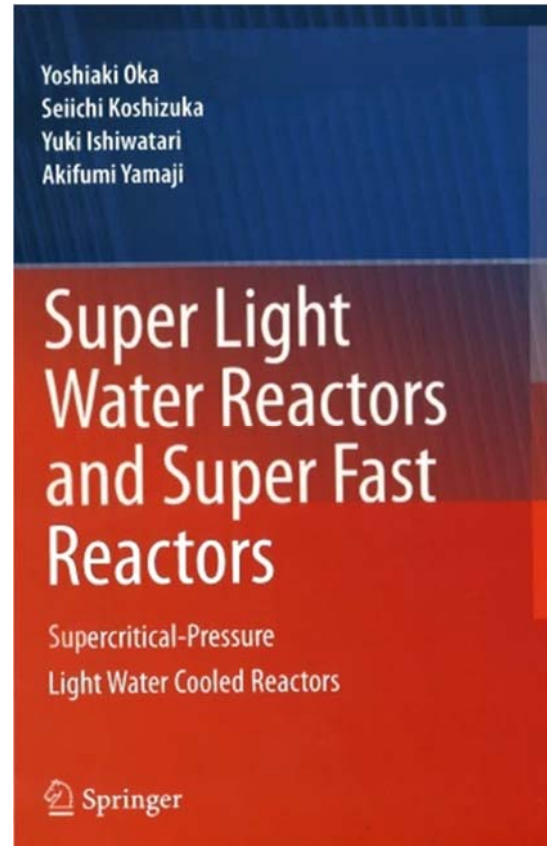

Thank you