

# FLASH.

The Free-Electron Laser  
in Hamburg



New technologies for new science: Soon X-ray free-electron lasers will enable us to probe ultrafast physical, chemical and biochemical processes at atomic resolution, opening new frontiers for science and technology. At long last we may see, and not just model, how molecular machines really work.

Accelerators | [Photon Science](#) | Particle Physics

Deutsches Elektronen-Synchrotron  
Member of the Helmholtz Association





# CONTENTS.

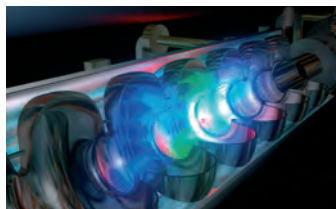

<b>Preface</b>	<b>2</b>	We would like to introduce to you a new research facility of unprecedented features – FLASH, the Free-Electron Laser in Hamburg.
<b>FLASH and XFEL</b>	<b>4</b>	<b>Time to explore the femtosecond dynamics of nature</b> Soon X-ray free-electron lasers will enable us to probe ultra-fast physical, chemical and biochemical processes at atomic resolution, opening new frontiers for science and technology. At long last we may see, and not just model, how molecular machines really work.
<b>How it works</b>	<b>8</b>	<b>The free-electron laser principle and the FLASH accelerator</b> FLASH, the Free-Electron Laser in Hamburg, is the first free-electron laser worldwide to produce femtosecond pulses of soft X-rays. In 2013, the planned European XFEL facility will deliver hard X-ray pulses far shorter than those from any other X-ray source, and their peak brilliance will be six to eight orders of magnitude higher. The unprecedented shortness and intensity of the X-ray pulses as well as their coherence open entirely new fields of research.
<b>The user facility</b>	<b>22</b>	<b>From the source towards the experiments</b> The FLASH experimental hall starts 30 meters behind the last dipole magnet that separates the electron bunches and the photon beam emerging from the long undulator in the accelerator tunnel. The photon beam transport system in the hall delivers the FEL pulses – as short as 10 femtoseconds – to the experimental stations.
<b>Research and science</b>	<b>32</b>	<b>First results and experimental possibilities at FLASH</b> Both the FLASH facility itself and the user experiments have made tremendous progress during the first two years. Many experiments took promising data and demonstrated the feasibility of new concepts.
<b>FLASH and its perspectives</b>	<b>44</b>	<b>Improvements for the users, self-seeding, faster beam switching and more</b> The main goal at FLASH in the next few years is to extend the possibilities for frontline research that may lead to scientific breakthroughs. Thus, several technological developments are being considered in order to improve the performance of the FEL.
<b>Further reading</b>	<b>48</b>	Status: April 2007



Björn H. Wiik (1937 - 1999)

1992 - 1999 Chairman of the DESY Directorate

---

## How FLASH grew up

- In 1991, the international TESLA collaboration of 55 institutes in 12 countries embarked on a major enterprise to push the performance of superconducting cavities to ultimate gradients while at the same time significantly reducing their cost. The aim was to demonstrate the feasibility of a superconducting linear electron-positron collider for elementary particle physics in an energy range inaccessible to existing accelerators. It was decided to build the TESLA Test Facility (TTF) at DESY, with major components contributed by the members of the collaboration in Europe and the USA. The goal was to prove that one can build superconducting accelerator structures of high performance and at competitive costs compared to conventional copper structures.
  - In parallel, in 1992 at SLAC in Stanford, California, a workshop on fourth-generation light sources focused on linear-accelerator-driven X-ray lasers, while the scientific applications of such coherent X-rays were discussed at SLAC in February 1994. In March 1994, a working group at DESY started to investigate the possibilities of using TTF and later the TESLA linear collider not only for accelerator and particle physics, but also as new light sources. This had immediate consequences: It was decided to add to TTF a powerful source of electrons, a so-called bunch compressor to produce short pulses, and a set of undulators to generate laser light.
  - Furthermore, two steps were envisaged: The first step would aim at a demonstration of the feasibility of an ultraviolet free-electron laser and would be financed by the TESLA collaboration. This would be followed as a second step by an upgrade of the accelerator to 1 GeV, thereby extending the wavelength range into the soft X-ray regime, and by the addition of a user facility. A key milestone in the development of TTF was reached when the first beam was accelerated to 80 MeV in June 1997. In February 2000, first lasing was observed at a wavelength of 100 nm. Shortly afterwards, very exciting pioneering experiments were performed.
  - With the proof of principle in hand, TTF was upgraded as planned to become a user facility. This upgrade entailed a more than doubling of the length of the accelerator and the addition of a new experimental hall. When the former German Chancellor Gerhard Schröder inaugurated the official user operation in August 2005, the name of the facility was changed, following the desire of the users: What had started as TTF became FLASH, the Free-Electron Laser in Hamburg.
-

# PREFACE.

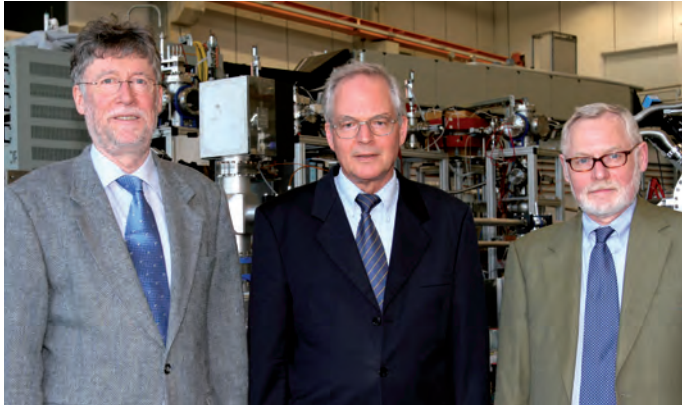

We would like to introduce to you a new research facility of unprecedented features – FLASH, the Free-Electron Laser in Hamburg.

From left to right:  
Albrecht Wagner, Chairman of the DESY Directorate  
Jochen R. Schneider, Director for Photon Science  
Dieter Trines, Director for Accelerators

FLASH produces laser light of short wavelengths from the extreme ultraviolet down to soft X-rays. Its peak brilliance is one billion times more intense than that of the best light sources today. The light comes in pulses, as in an electronic flashlight, but the pulses are a 100 billion times shorter. At free-electron lasers (FELs), one obtains in light flashes of only 10 femtoseconds duration as many photons as what can be obtained per second from the best X-ray sources today.

In this brochure, the novel technologies and the free-electron laser principle are explained on a level which should be useful to graduate students if they want to understand things beyond pure excitement, but also to scientists who may become interested in using this new tool for their own research. The brochure therefore describes the properties of the radiation, the diagnostic tools and the layout of the experimental hall of FLASH, followed by first scientific results which have already attracted worldwide attention. In line with the fact that the development of free-electron lasers and their usage is only just beginning and new ideas come up all the time, the brochure finishes with a chapter on the perspectives for further upgrades and new possibilities for the FLASH users. In addition, the relevant papers on work at FLASH are listed at the end of the brochure and compiled in the attached CD.

FLASH grew out of an international effort, the TESLA collaboration, to develop the technology for a superconducting

linear collider for particle physics. The success of FLASH is an important step on the way to X-ray FELs. It considerably raised the international attention and interest in this new tool. Several FELs for hard X-rays are under construction, one at SLAC in California, one in Japan, followed by the European XFEL in Hamburg. More are likely to follow.

Today, in 2007, and for the next few years FLASH fulfils the task of the first explorer in many aspects in science, technology, and data collection. At the same time FLASH teaches us a lot about how to build the European XFEL. FLASH also remains an essential test bed for the technology of superconducting accelerators and thus for the International Linear Collider (ILC), which will apply the same technology.

FLASH owes enormously to the vision of Björn Wiik (1937 - 1999), both in his role as spokesman of the TESLA collaboration and chairman of the DESY directorate. He liked to quote the philosopher Lichtenberg: "To see something new requires doing something new." – FLASH is doing just that.

Facilities like FLASH are opening windows into unknown territories, thus attracting particularly the next generation of scientists. We hope the brochure will illuminate you and will tell you about the excitement which is shared by all those who are contributing to this success and whom we would like to thank on this occasion.

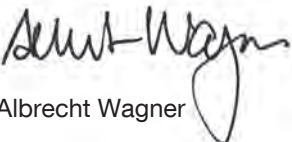
  
Albrecht Wagner

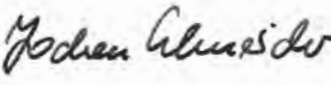
  
Jochen R. Schneider

  
Dieter Trines

# FLASH AND XFEL.

Time to explore the  
femtosecond dynamics of nature

Soon X-ray free-electron lasers will enable us to probe ultrafast physical, chemical and biochemical processes at atomic resolution, opening new frontiers for science and technology. At long last we may see, and not just model, how molecular machines really work.

During the 20th century science made some of its greatest breakthroughs by focusing on *structure*; from Niels Bohr's model of the electronic structure of the atom to the determination of the three-dimensional atomic structure of large biomolecules such as the ribosome, the protein factory of all living creatures, built from half a million atoms. Structure is paramount to the function of any molecule, solid, polymer, catalyst, chemical, protein, drug or living cell, but nevertheless structure is only the starting point to explore how molecular machines perform their countless tasks for real.

It is like a game of chess. Structure determines if a piece is a queen or a pawn, and that is mandatory to know. But the game unfolds by setting the pieces into motion. This applies just as well to molecules participating in physical, chemical or biochemical processes. To fully understand we need to learn how these molecules move atom by atom during their incredibly fast interactions. Therefore *dynamics* will be the key word for science in this new century.

The quest has already begun. With femtosecond lasers researchers have recorded chemical reactions as fast as they come. But so far the wavelengths of lasers have been too long to see individual atoms in molecules. Only hard X-rays

have the power to do this, but the picosecond time scale that can be reached at 3rd generation synchrotron light sources is a thousand times too slow to catch all the steps in such reactions. To probe the dynamics of nature at the atomic level we need pulsed femtosecond X-ray free-electron lasers, and over the next decade scientists in Europe, Japan and the USA are going to get them.

## World record at FLASH

Right now researchers at the Deutsches Elektronen-Synchrotron (DESY) laboratory in Hamburg are on the international frontline developing the methods for recording femtosecond dynamics at atomic resolution. A femtosecond is a millionth of a billionth of a second; in a second light travels from the Earth to the Moon, in 50 femtoseconds it just crosses a human hair.

Their tool is the 260-meter-long pilot facility FLASH, which in 2006 set a world record by producing the most brilliant femtosecond pulses ever of extreme-ultraviolet radiation with wavelengths down to 13.1 nanometers. These pulses can be as short as 10 femtoseconds. An upgrade in 2007 will push the wavelength down to 6.5 nanometers and further

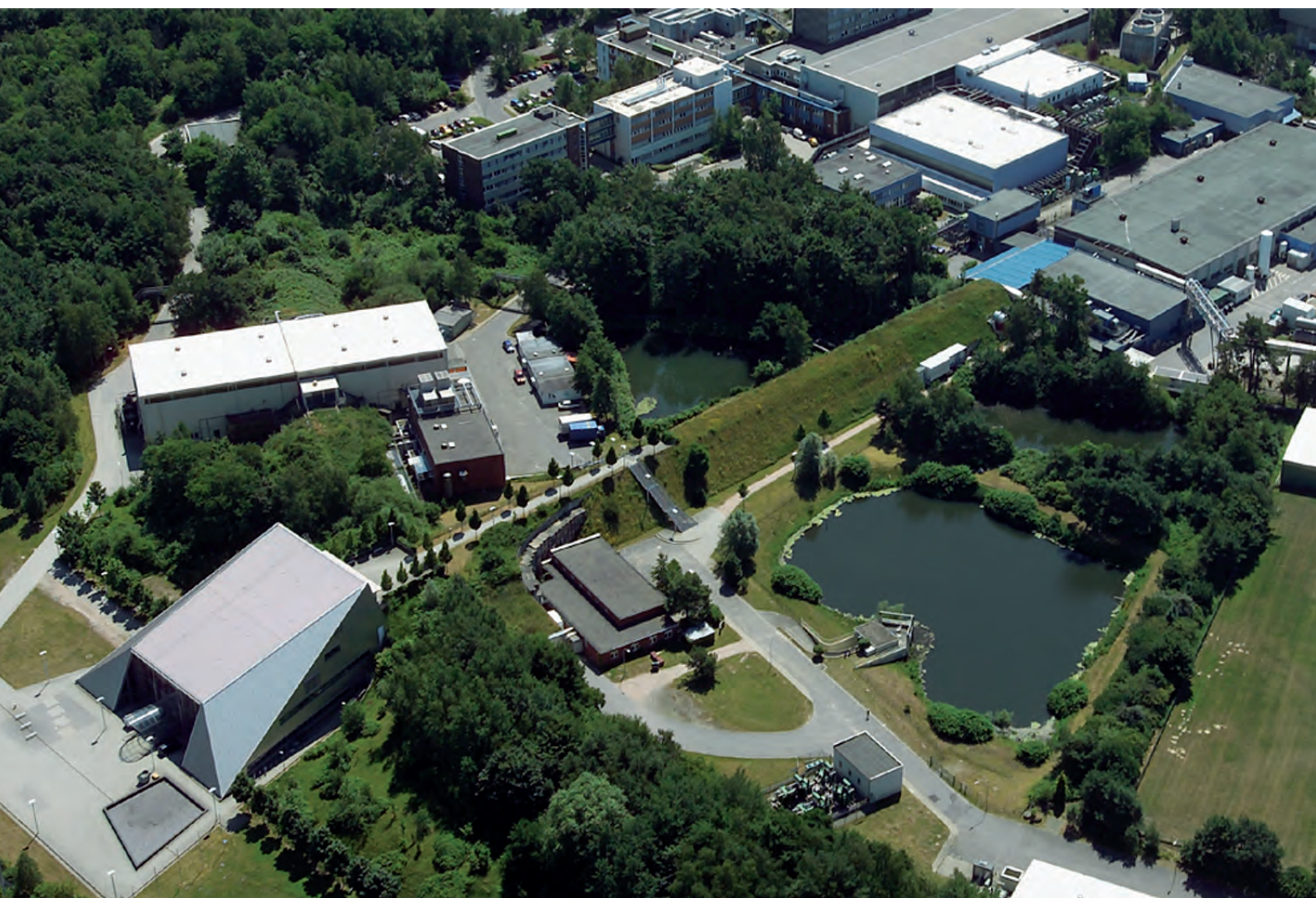

into the soft X-ray regime. “The first model experiments strongly support that it will be possible to probe molecular interactions at the atomic level, when the 3.4-kilometer-long European X-ray Free-Electron Laser (XFEL) comes into operation in 2013,” says Josef Feldhaus, who coordinates the experiments at FLASH. DESY and its international partners recently published the Technical Design Report for this dream machine. The XFEL will produce femtosecond pulses of hard X-rays with wavelengths down to 0.1 nanometers able to resolve atomic structures, and it will deliver these extremely brilliant pulses as coherent laser light ideal for imaging. “So far X-rays have shown us ground state structures of molecules. The XFEL will record chemical and biochemical reactions at atomic resolution. Only then will we know how molecular machines really work,” says DESY Research Director Jochen Schneider.

### Single-shot imaging

X-ray free-electron lasers are single-shot machines, and the spatially focused X-ray pulses can be so intense that they blow the sample apart. However, the ultrashort pulses should enable researchers to record a full diffraction pattern or an image of the sample before it explodes. A group led by Janos

Hajdu from the University of Uppsala in Sweden and Henry Chapman from the Lawrence Livermore National Laboratory in California performed a model experiment at FLASH that supports the view. The experiment was a test of the methods to be applied at the XFEL to resolve the structure of large biomolecules in a single flash. “In the future we may no longer need crystals of biomolecules to obtain their structures. If we ever shall be able to study living cells at atomic resolution, this is the route,” says Janos Hajdu.

Today there is no escape. To solve the structures of large biomolecules such as proteins or viruses, researchers first have to grow crystals containing millions of aligned molecules to get a sufficiently strong signal using the X-ray beams from synchrotron storage rings. “But real life is not crystallized,” says Janos Hajdu. Apart from this fundamental limitation, many important biomolecules resist being crystallized. An example are human cell membrane proteins which are the most important drug targets. If their structures can be resolved from a few or even individual proteins with single shots from X-ray free-electron lasers, the importance for pharmaceutical research can hardly be overestimated. Drugs could then be tailor-made to fit into exactly the right receptors, but no others, like a hand that slides into a glove. ➤

## Molecular action movies

An important effort at FLASH is to develop methods for making molecular movies with atomic resolution in the femto-second regime. Such time-resolved studies aim at recording fast chemical or biochemical reactions by pump-and-probe experiments. A reaction can be started with an optical laser pulse and then probed by the femtosecond X-ray pulse, or the X-ray pulse can be split in two to act as both pump and probe. Each shot of probing X-rays destroys the sample, and to record molecular dynamics several probe pulses must be applied to reproducible samples at different time intervals after the reaction has been initiated by the pump pulse. The research at FLASH has boosted the confidence that this is indeed possible. An experiment studying the photoionization of rare gases has demonstrated for the first time that femto-second time-resolved experiments can be performed at X-ray free-electron lasers by synchronizing a femtosecond optical pump pulse with the femtosecond probe pulse from FLASH.

## From atom to solid

X-ray free-electron lasers will open new avenues for materials science and nanotechnology. An example is the investigation of the structure of nanocrystals and atomic clusters consisting of a few thousand atoms. While both single atoms and solids are well characterized, the intermediate states of atomic clusters are not, and physicists do not know how many atoms are needed before a cluster turns into a solid, or how this transition occurs.

The first model experiments on clusters have been carried out at FLASH. “A system has been set up for producing metal clusters of various sizes in order to investigate their electronic states. When the XFEL comes into operation it may be possible to map the entire spectrum from a single atom to a solid,” says Josef Feldhaus. The size of clusters controls their electronic and magnetic properties as well as their chemical reactivity, and from a technological point of view a thorough understanding of these properties holds great promise for e.g. nanoelectronics.

## Astrophysics in the lab

At FLASH a large research group is developing methods to study plasma dynamics at atomic resolution when the XFEL comes into operation. This effort may open a new field of experimental astrophysics. Plasmas form the bulk of stars and can be created in the laboratory by hitting a sample with an X-ray pump pulse. Then a femtosecond X-ray probe pulse records the behavior of the plasma with atomic resolution before it decays. “This approach may enable us to study for the first time how plasmas form, behave and decay,” says DESY scientist Thomas Tschentscher.

A prime goal is to determine the opacity of stars which cannot be deduced from astronomic observations. The fusion power plant in the stellar core emits a lot of radiation, but how much of this radiation and what wavelengths are absorbed by plasmas deep within the star? How representative is the light that reaches the surface to be detected by the astronomers?

The experiments at the XFEL may answer such questions, providing important input to stellar models. Plasmas of different temperatures and densities can be created – mimicking the conditions inside a star – and the opacity of these plasmas to radiation of different wavelengths can be mapped out. Another important target for experimental astrophysics are highly charged ions – almost stripped down to the bare nuclei – that constitute the bulk of the visible matter in stars, supernovae, near-stellar clouds, and shocks and jets from active galaxies.

At FLASH highly charged ions like iron  $\text{Fe}^{23+}$  have been produced in an ion trap, and the interactions between light and the remaining three electrons has been measured using femtosecond pulses from the free-electron laser. Such studies may not only provide important input to stellar models; they may also test with an unprecedented accuracy the theory of quantum electrodynamics (QED) which describes electromagnetism.

---

## Faster and more brilliant than ever

FLASH is based on the same technology that will be applied at the XFEL, and the pilot facility is indispensable for the construction and operation of the large European facility. “Without FLASH no one would dare to build the big one,” says Jochen Schneider. To produce femtosecond X-ray pulses, electrons are accelerated to high energies in a superconducting linear accelerator, and

at the end of the linac the electrons bunches pass through a magnetic configuration called an undulator. Electrons emit radiation when their path is curved, and this is exactly what happens as the electrons are forced onto a slalom course by the magnetic field of the undulator. Undulators have been in operation for years at synchrotron storage rings where the electrons emit spontaneous radiation with different phases. The technological revolution of X-ray free-electron lasers lies in the fact

that their extremely long undulators produce coherent X-rays, where the light waves are in phase as in a laser beam. Furthermore, the ultrashort femtosecond pulses are extremely brilliant and tunable in wavelength.

## The SASE principle

The key to this amazing feat is the SASE principle (Self-Amplified Spontaneous Emission). At the beginning the electrons flying on their slalom





The undulator section in the FLASH tunnel

## New samples for new science

“At FLASH and XFEL we are going to look at completely new types of samples. It may be membrane proteins in their natural environment, the lipid cell membrane. It may be viruses in a stream of gas, or it may be gases containing tiny amounts of highly charged ions that are present in jets from quasars on the brink of the visible universe. We may investigate promising new materials trapped inside nanodroplets and we may study stick–slip friction in lubricating thin films at the atomic level. Such experiments will open entirely new windows for science and technology, and it is hard to predict what we will find eventually,” says Jochen Schneider. ●

*By Rolf Haugaard Nielsen, Science journalist*

TDR: [http://xfel.desy.de/tdr/index\\_eng.html](http://xfel.desy.de/tdr/index_eng.html)  
XFEL portal: [www.xfel.net](http://www.xfel.net)

## Fields of opportunity

- Ever seen the machinery of a living cell at work at atomic resolution?
- Observed how molecules change shape in femtoseconds during chemical or biochemical reactions?
- Watched a drug molecule enter a protein receptor in real time?
- Measured the opacity of plasmas to determine the quality and quantity of the radiation that makes it from the core of a star out to the surface?
- Examined the highly charged ions abundant in stars, supernovae, near-stellar clouds and jets from active galactic nuclei?
- Seen ion channels at work in the cell membrane? Watched atomic clusters turn into a solid? Observed stick–slip friction atom by atom?

Until now such studies in the femtosecond regime have been beyond the reach of science. But over the next few years a new type of light sources, X-ray free-electron lasers, will become available and they may, finally, help us to tear down the curtain and open the window to the ultrafast dynamics of nature at the atomic level.

course through the undulator emit X-ray photons spontaneously, and soon the photons traveling in a straight line at the speed of light overtake the electron bunches. The photons form an electromagnetic field and this field interacts with the electrons on their slalom path. Electrons that are in phase with the transverse pulsating field get decelerated as it passes by, while out-of-phase electrons are accelerated. Gradually this process packs the electrons into microbunches that are overtaken by

exactly one photon wavelength for each of their wiggles. When this happens all the electrons of the microbunches radiate in sync, producing an extremely short, coherent and intense pulse of X-rays.

## Getting ready for the XFEL

In 2006, a European project team headed by Massimo Altarelli and located at DESY published the Technical Design Report (TDR) for the XFEL. The 600-

pages report spells out in detail how to construct and operate the 3.4-kilometer-long European X-ray Free-Electron Laser. As described in the TDR, its construction cost will amount to around 1 billion euros in year 2005 prices. Commissioning of the first three beamlines and six experimental stations will start in 2013. The foundation of the XFEL Limited Liability Company, which will be composed of the involved countries, is envisaged for the end of 2007.

# HOW IT WORKS.

## The free-electron laser principle and the FLASH accelerator

FLASH, the Free-Electron Laser in Hamburg, is the first free-electron laser worldwide to produce femtosecond pulses of soft X-rays. In 2013, the planned European XFEL facility will deliver hard X-ray pulses far shorter than those from any other X-ray source, and their peak brilliance will be six to eight orders of magnitude higher. The unprecedented shortness and intensity of the X-ray pulses as well as their coherence open entirely new fields of research.

The Free-Electron Laser (FEL) principle has been known since the early 1970s, but it became clear only in recent years that these devices have the potential of becoming exceedingly powerful light sources in the X-ray regime.

### Electron synchrotrons as short-wavelength light sources

So far the most brilliant X-rays have been produced in circular electron accelerators called synchrotrons. In early synchrotrons the radiation was produced in the bending magnets of the storage rings. Here the relativistic high-energy electrons are accelerated towards the centre of the ring and emit synchrotron radiation tangentially to their circular orbit. The frequency spectrum is continuous and extends from the microwave region into the optical and X-ray regime, depending on the electron energy.

In modern synchrotron light sources the radiation is produced in undulator magnets. These are periodic arrangements of many short dipole magnets of alternating polarity. The electrons move on a wavelike curve through the undulator, but the overall deflection of the beam is zero. Undulator radiation is far more useful for research

than radiation from bending magnets because it is almost monochromatic.

To understand the properties of undulator radiation we need the theory of special relativity. One important consequence of relativity is that the mass of a particle grows when it is accelerated to very high energies. An electron that has traversed a voltage of 500 million volts – the energy is then 500 MeV – has a moving mass which is a thousand times larger than the rest mass. A second important result is relativistic length contraction; a moving bar appears to be shortened. Thirdly, the radiation emitted by a source moving with high speed towards an observer is strongly blue-shifted by the relativistic Doppler effect. This phenomenon is similar to the well-known acoustical Doppler effect; the sound of a motorcycle driving towards you with high speed is shifted to higher frequency, but when the motorcycle moves away from you, the sound is shifted to lower frequency.

Now we put ourselves into a wagon moving through the undulator with the average speed of the electrons, which is very close to the speed of light. As the undulator moves towards us its period appears length-contracted, and the

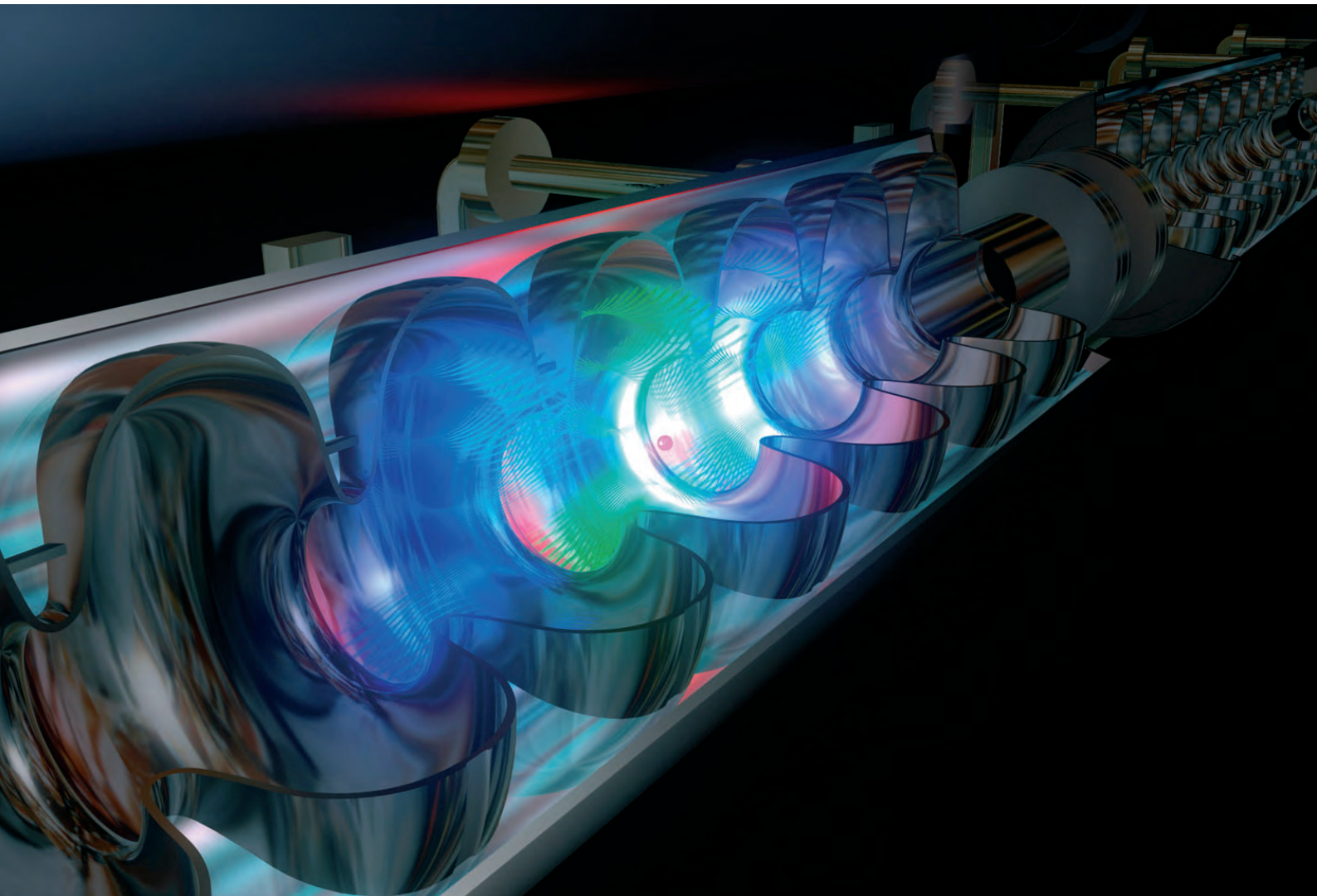

electrons in the wagon oscillate at a high frequency and emit their radiation. The observer in the laboratory sees a source that approaches him with high speed, and the relativistic Doppler effect boosts the frequency more than thousandfold. As a consequence of the length contraction and the Doppler effect, the wavelength of undulator radiation is about a million times shorter than the undulator period. The intensity is concentrated in a narrow spectral range. Different electrons radiate independently, hence the total energy produced by a bunch of  $N$  electrons is just  $N$  times the radiation energy of one electron.

### Free-electron lasers and conventional lasers

The next big improvement in the performance of accelerator-based light sources is given by the free-electron laser. The main components of an FEL are an accelerator providing a bunched relativistic electron beam and an undulator magnet. In an FEL many electrons radiate coherently. The radiation power then grows quadratically with the number of these particles. For a typical number of  $10^6$  electrons in a coherence region, the FEL will yield a million times higher light output than an undulator in a synchrotron.

The word LASER is an acronym for Light Amplification by Stimulated Emission of Radiation. A conventional quantum laser consists of three basic components: a laser medium with at least three energy levels, an energy pump, and an optical resonator. Stimulated emission takes place between an excited state  $E_2$  and the ground state  $E_1$ . A higher level  $E_3$  is needed to achieve a population inversion by pumping many electrons from  $E_1$  to  $E_3$  from where they make a fast transition to  $E_2$ . The axis of the optical cavity defines the direction of the photon beam. In a mono-mode laser exactly one optical eigenmode of the cavity is excited. The photons in this mode are all in the same quantum state, and the probability for stimulated emission from  $E_2$  to  $E_1$  is proportional to the number of photons present in this state.

In a free-electron laser the role of the active laser medium and the energy pump are both taken over by the relativistic electron beam. The electrons are not bound to atomic, molecular or solid-state levels but are moving freely in vacuum. The pump source is the large kinetic energy of the electrons. Stimulated emission takes place from higher to lower kinetic energies under the action of an already existing light wave, e.g. from an optical laser. ➤

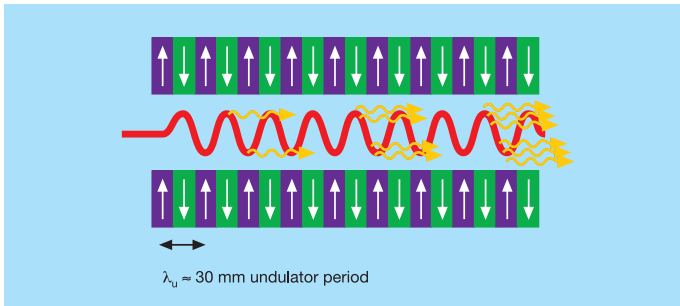

Schematic representation of undulator radiation. To simplify the picture the wavelike electron trajectory is drawn in the plane of the drawing while in reality it is perpendicular to this plane. The amplitude of the wavelike curve is exaggerated, it amounts to only a few micrometers.

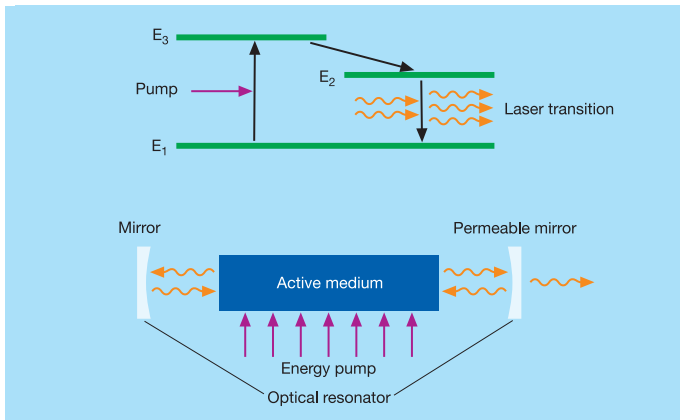

Principle of a conventional quantum laser where the electrons are bound to atomic, molecular or solid-state energy levels ("bound-electron laser").

## Special relativity and undulator radiation

As the electrons are accelerated to high energies and relativistic speeds, the ratio between their moving and rest mass (resp. the ratio between total energy  $W$  and rest energy  $W_0$ ) is called the Lorentz factor:

$$\gamma = \frac{m}{m_0} = \frac{W}{W_0}$$

The relativistic length contraction of the undulator is determined by the factor  $1/\gamma$ . The radiation that is emitted by electrons moving with high speed towards an observer is blue-shifted by a factor of about  $1/(2\gamma)$  by the relativistic Doppler effect. We can then estimate the wavelength of undulator radiation by applying special relativity twice. We call  $\lambda_u$  the period of the magnet arrangement, which is the distance between two identical poles. A typical value is  $\lambda_u = 30 \text{ mm}$ . As the electrons move straight through the undulator with an average speed close to the speed of light its period appears length-contracted to  $\lambda^* = \lambda_u/\gamma = 30 \mu\text{m}$  for  $\gamma = 1000$ . The electrons oscillate at a high frequency and emit radiation with the wavelength  $\lambda^*$ . The observer in the laboratory sees a source that approaches him with high speed. The relativistic Doppler effect then reduces the light wavelength to  $\lambda_e \approx \lambda^*/(2\gamma) = \lambda_u/(2\gamma^2) = 15 \text{ nm}$ .

The motion of the electrons on their slalom path produces a velocity component along the transverse electric field of the light wave, resulting in an energy exchange between the electrons and the light wave. Specifically, the coupling between the electron and the light wave is proportional to the electric field strength of the wave, and the FEL gain is proportional to the number of photons in the light wave. Hence one is well justified to speak of light amplification by stimulated emission of radiation when talking about a free-electron laser. Moreover, the light emerging from an FEL has the same properties as conventional laser light in that a huge number of coherent photons are contained in a single optical mode.

An FEL operating at infrared and optical wavelengths can be equipped with an optical resonator, but this is no longer possible if the wavelength is decreased below 100 nm, because here the reflectivity of metals and other mirror coatings drops quickly to zero at normal incidence. In the extreme-ultraviolet and X-ray regime a large laser gain has to be achieved in a single passage of a very long undulator magnet. The principle of Self-Amplified Spontaneous Emission (SASE) allows the realization of high-gain FELs at these short wavelengths.

## Low-gain FEL with an optical cavity

The main components of low-gain FELs operating at infrared and optical wavelengths are an electron storage ring or a recirculating linear accelerator in which a train of relativistic electron bunches makes many revolutions, a short undulator magnet, and an optical cavity.

We assume the presence of an initial light wave which may be provided either by an external source such as an optical laser, or by the spontaneously emitted undulator radiation which is captured into an optical eigenmode of the cavity. The bunches take many turns through the undulator. Upon each turn the light intensity grows by only a few percent, which is the reason why such a device is called a low-gain FEL. The small gain per undulator passage, however, does not prevent the FEL from reaching very high output powers in the order of Gigawatts, if the electron beam makes a sufficiently large number of turns.

## Energy transfer from electron beam to light wave

An electron beam moving on a straight line cannot transfer energy to a light wave. The reason why is the transverse polarization of electromagnetic waves: The electric field is perpendicular to the direction of motion, and the force between electron and light wave is orthogonal to the electron velocity, which implies that no work is done on the electron. In order to facilitate energy exchange, the electrons must be given a velocity component in the transverse direction. This is what happens in the undulator.

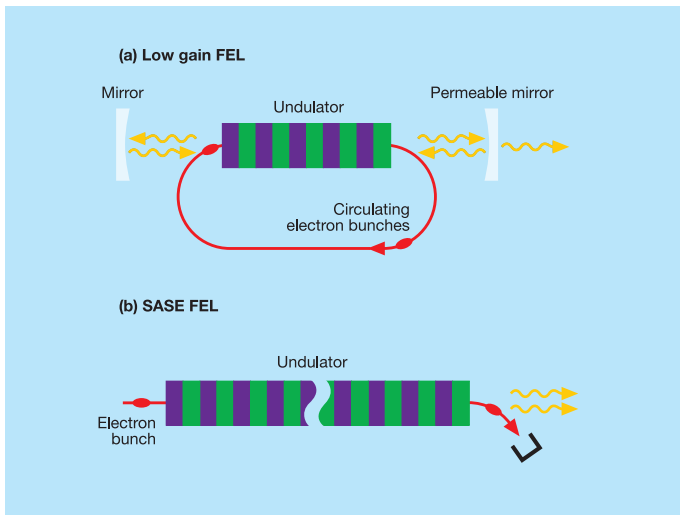

Principle of a free-electron laser: (a) For visible or infrared light an optical resonator can be used. A gain of a few percent for each passage of a short undulator magnet is sufficient to achieve laser saturation within many round trips through the undulator. (b) In the ultraviolet and X-ray region one can apply the mechanism of self-amplified spontaneous emission where the laser gain is achieved in a single passage of a very long undulator.

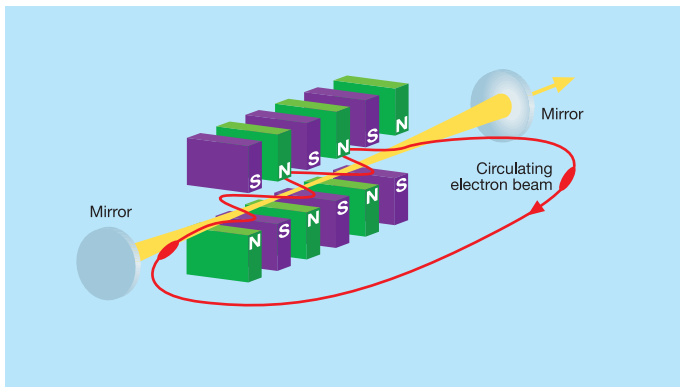

Principle of a low-gain FEL with an optical resonator

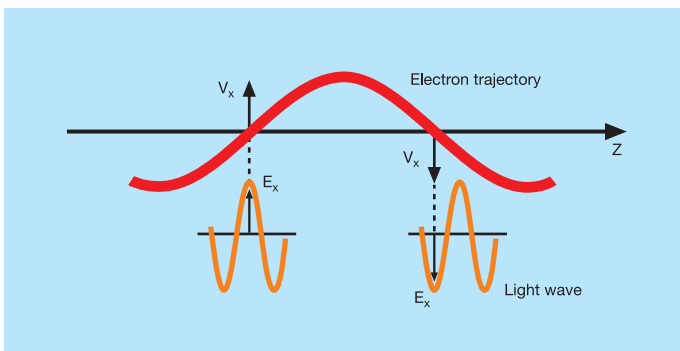

Condition for sustained energy transfer from electron to light wave in an undulator: The light wave has to slip forward by  $\lambda_e / 2$  per half-period of the electron trajectory.

The transverse component of the electron velocity and the electric vector of the light wave must point in the same direction to get an energy transfer from the electron to the light wave. Now a problem arises. The light wave, traveling with the speed of light, will obviously slip forward with respect to the electrons; firstly, because the electrons are massive particles and thus slower than light, and secondly, because they travel on a slalom orbit which is longer than the straight path of the photons. The question is then: How is it possible at all to achieve a steady energy transfer from the electron beam to the light wave along the entire undulator? The answer is that the light wave has to slip by the right amount, and this proper slippage is only possible for a certain wavelength. The transverse velocity and the electromagnetic field of the light wave remain parallel if the light wave slips by half an optical wavelength in a half-period of the electron trajectory.

This condition allows us to compute the proper light wavelength (see “The physics of free-electron lasers” on page 20):

$$\lambda_e = \frac{\lambda_u}{2\gamma^2} \left( 1 + \frac{K^2}{2} \right)$$

The calculation shows that the proper light wavelength is identical with the wavelength of undulator radiation in the forward direction. This equality is the physical basis of the self-amplified spontaneous emission mechanism: Spontaneous undulator radiation can serve as seed radiation for a high-gain FEL. The formula displays one of the great advantages of the FEL; in contrast to conventional lasers the wavelength of an FEL can be varied at will, simply by changing the electron energy.

Now the second problem arises: The electron bunch is far longer than the light wavelength. Generally the electrons will be distributed uniformly along the bunch axis, and although there are many electrons fulfilling the condition that their transverse velocity is almost parallel to the pulsating electromagnetic field and which thus transfer energy to the light wave, there will be equally many anti-parallel electrons and they will withdraw energy from the light wave. How can one then achieve an overall amplification of the light wave? The net energy exchange between electron bunch and light wave is in fact zero if the electron energy is equal to the resonance energy, where the electrons emit undulator radiation of exactly the incident wavelength. However, there will be light amplification if the electron energy is above the resonance energy, but light attenuation if the energy is below that value. >

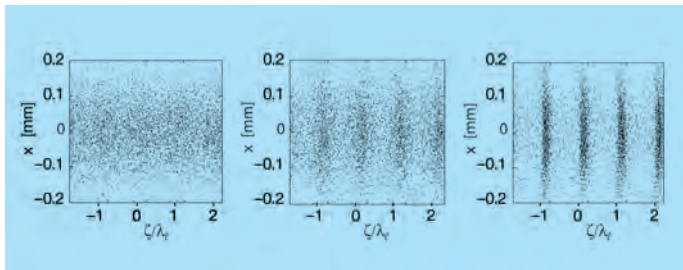

Numerical simulation of microbunching

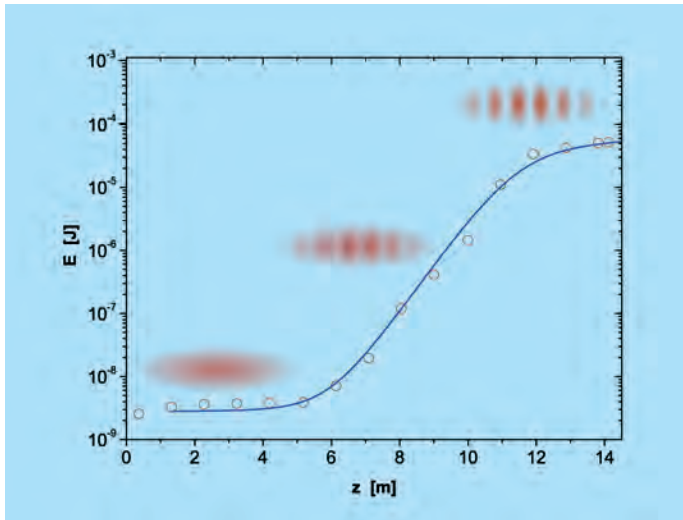

The exponential growth of the FEL pulse energy  $E$  as a function of the length  $z$  traveled in the undulator. The data (open red circles) were obtained at the first stage of the SASE FEL at DESY, the electron energy was 245 MeV. The solid curve shows the theoretical prediction. The progress of microbunching is indicated schematically. Laser saturation sets in for  $z \geq 12$  m. Here the microbunches are fully developed and no further increase in laser power can be expected.

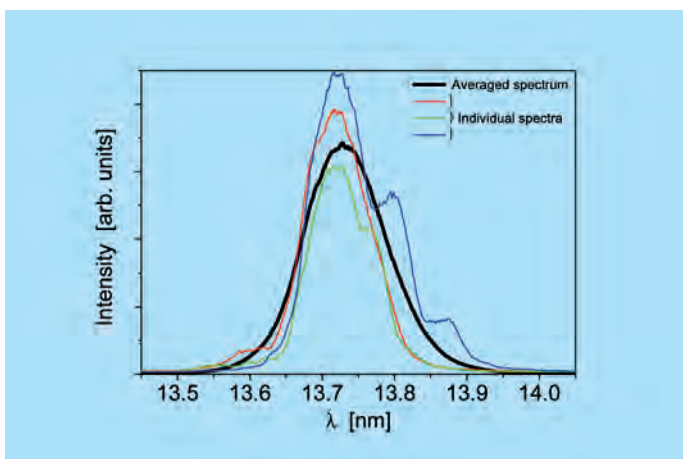

The measured spectra of individual SASE FEL pulses at an average wavelength of 13.73 nm. The single-shot spectra show two to three peaks which fluctuate in size, position and height from shot to shot. The average spectrum of 100 FEL pulses is wider than the individual spikes. Its shape is in agreement with theoretical predictions.

## High-gain FEL by microbunching

The essential advantage of FEL radiation as compared to undulator radiation is its much higher intensity because a large number of electrons radiate coherently. If it were possible to concentrate all electrons of a bunch into a region far smaller than the light wavelength, then all these particles would radiate like a “point macroparticle”. The problem is, however, that the concentration of some  $10^9$  electrons into such a tiny volume is totally unfeasible, even the shortest particle bunches are much longer than the wavelength of an X-ray FEL.

The way out of this dilemma is given by the process of microbunching, which is based on the following principle: Electrons losing energy to the light wave travel on a wave-like trajectory of larger amplitude than electrons gaining energy from the light wave. The result is a modulation of the longitudinal velocity which eventually leads to a concentration of the electrons in slices that are shorter than the wavelength. These microbunches are close to the positions where maximum energy transfer to the light wave can happen, and the particles within a microbunch radiate like a single particle of high charge. This increase in the radiation field enhances the microbunching even further and leads to an exponential growth of the energy of the radiation pulse as a function of the length of the undulator.

The FEL power is almost constant in the first section of the undulator, an exponential growth starts only after a certain distance. The exponential regime ends when the microbunches are fully developed and no more electrons are available for increasing the periodic density modulation. Then the FEL power levels off. In this saturation regime it may even happen that energy is pumped back from the light wave into the electron beam.

A key quantity for the technical realization of a high-gain FEL is the gain length, that is the length in which the FEL power grows by a factor  $e = 2.718$ . At FLASH the gain length is about 1 meter. The gain length depends critically on the electron beam parameters. To obtain a short gain length, the peak current in the bunch must be very high, in the order of several 1000 A, and the electron beam diameter must be less than 100  $\mu\text{m}$  throughout a long undulator magnet. With increasing electron energy, and correspondingly decreasing FEL wavelength, the gain length grows, and longer undulators are needed. At FLASH the undulator is 27m long, but FELs operating in the hard X-ray regime will be technically even more demanding. In order to achieve laser saturation at a sub-nanometer wavelength the undulator must be more than 100 m long.

Another key quantity is the FEL parameter, which is in the order of a few permille at FLASH. This parameter characterizes two important properties of the FEL: The bandwidth in the saturation regime is equal to the FEL parameter, and the laser power at saturation is the FEL parameter times the

power of the electron beam. Unfortunately the FEL parameter drops by an order of magnitude when going into the X-ray region.

## Self-Amplified Spontaneous Emission (SASE)

For wavelengths in the ultraviolet and X-ray regime the start-up of the FEL process by seed radiation is difficult due to the lack of suitable lasers. In principle it can be done by choosing a high harmonic of optical laser radiation. The process of Self-Amplified Spontaneous Emission (SASE) permits the start-up at arbitrary wavelengths without the need for external seed radiation. The most intuitive explanation of SASE is that the electrons produce spontaneous undulator radiation in the first section of a long undulator magnet which then serves as seed radiation in the main part of the undulator.

The emission of spontaneous undulator radiation is a stochastic process, and thus the SASE process is characterized by fluctuations in wavelength and FEL pulse energy. In the exponential gain regime the pulse energy fluctuations are quite large, in the order of 70 percent in a recent FLASH measurement at a wavelength of 13.7 nm. When  $\rightarrow$

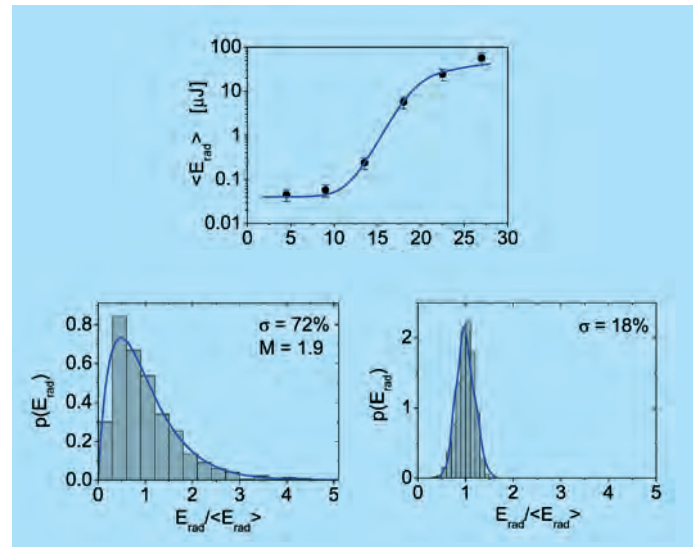

Top: the measured average FEL pulse energy as a function of the position  $z$  in the undulator, showing exponential growth and saturation. The wavelength is 13.7 nm. Bottom left: probability distribution of the FEL pulse energy in the exponential regime. The average pulse energy is 1  $\mu\text{J}$ . Bottom right: probability distribution of the FEL pulse energy in the saturation regime. The average pulse energy is 40  $\mu\text{J}$ .

## Higher harmonics open the water window

An important feature of FEL radiation is the existence of odd higher harmonics. Not only the fundamental wavelength  $\lambda_1 \equiv \lambda_e$  but also the wavelengths  $\lambda_3 = \lambda_1/3$  and  $\lambda_5 = \lambda_1/5$  are found in the spectrum, whereas the even harmonics  $\lambda_2 = \lambda_1/2$  and  $\lambda_4 = \lambda_1/4$  are forbidden by symmetry and occur only for misaligned beams.

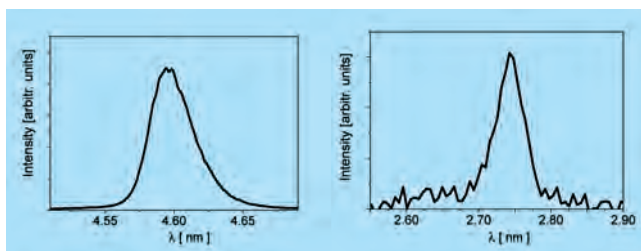

Spectra of the third (left) and the fifth harmonic (right) at a fundamental wavelength of 13.7 nm measured at FLASH.

The third harmonic of the 13.7 nm radiation has a wavelength of 4.6 nm, while the fifth harmonic has a wavelength of 2.7 nm, enabling FLASH to reach deep into the water window. This is a wavelength range that is crucially important for the investigation of biological samples because the radiation is able to "see" through water.

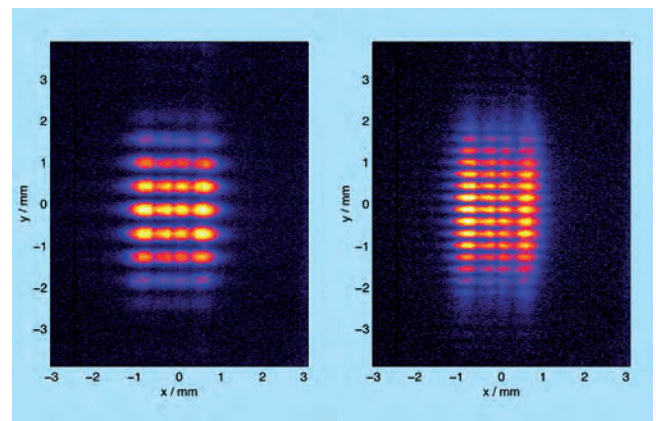

The FEL radiation has full transverse coherence, which has been demonstrated by double-slit diffraction experiments. The pictures show a double-slit diffraction pattern at a fundamental wavelength of 100 nm measured at FLASH. The slit separation is 0.5 mm in the left picture and 1 mm in the right picture.

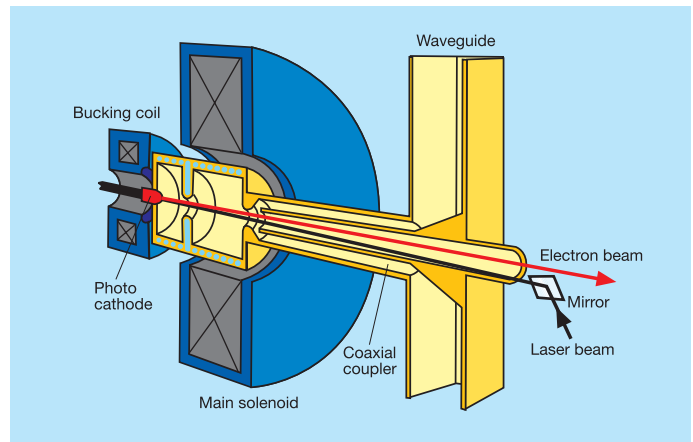

Cut through the electron source of FLASH. The Cs<sub>2</sub>Te photocathode is mounted at the backplane of a 1.3-GHz 1.5-cell copper cavity. The electric field assumes its maximum value at the cathode. The radio-frequency power of about 3 MW is guided to the cavity through a waveguide and a coaxial coupler. The UV laser beam is deflected onto the cathode by a small mirror outside the electron beam axis. A solenoid coil produces longitudinal field lines around which the electrons travel on helical trajectories. A second solenoid, called “bucking coil”, compensates the magnetic field in the cathode region where the photo-emitted electrons have very low energy.

saturation is reached the fluctuations drop to less than 20 percent. The origin of these fluctuations is easy to understand. The section in which the spontaneous radiation is produced may comprise typically 100 undulator periods corresponding to a bandwidth of 1 percent. If several electrons radiate independently the wavelength may therefore fluctuate by up to  $\pm 1$  percent. Moreover, the longitudinal position at which an electron emits its radiation will vary from particle to particle. The radiation which is emitted first profits most from the exponential amplification, while radiation starting at a later position will be lower on the gain curve. In the end, only a few of the initial radiation modes will survive because they absorb the lion’s share of the energy extracted from the relativistic electron bunch. Deep in the saturation region all excited modes will reach a plateau, and thus the FEL pulse energy variations will be much reduced.

### Requirements on electron beam quality

We have already addressed the importance of a high peak current for reducing the gain length. In practice this means that the bunches must be longitudinally compressed. An additional bonus of the bunch compression is the possibility to generate extremely short FEL pulses with durations in the 10-femtosecond regime.

The second requirement is a small beam cross section. A measure for the beam diameter is the emittance which is, loosely speaking, the product of radial beam size and

divergence. A low emittance means that it is possible to maintain a small beam diameter over a very long distance; this is exceedingly important in the undulators of an X-ray FEL which may be more than 100 m long. During acceleration the emittance shrinks inversely proportionally to particle energy, because the longitudinal momentum component of a particle is increased in the cavities, whereas the transverse component remains invariant. There are, however, perturbing effects (such as “wake fields”) that tend to enlarge the emittance. The amplification process in the high-gain FEL depends critically on a good transverse overlap between the electron and the photon beam. Ideally both beams should have the same cross section to ensure that the energy transfer is optimized all along the undulator axis.

The third requirement is a very low energy spread within the beam. In order to achieve laser saturation the energy spread must be less than half the FEL parameter. The achievement of an extremely low energy spread in the order of 0.01 percent is a serious technical challenge for FELs operating at sub-nanometer wavelengths.

The three requirements on the drive beam of an X-ray FEL – high peak current, very low emittance and very small energy spread – are so demanding that none of them can be fulfilled by an electron storage ring. Only linear accelerators (linacs) are suited to produce the drive beam. In particular, the extremely short electron bunches that are needed to generate femto-second X-ray pulses can only be produced in linacs equipped



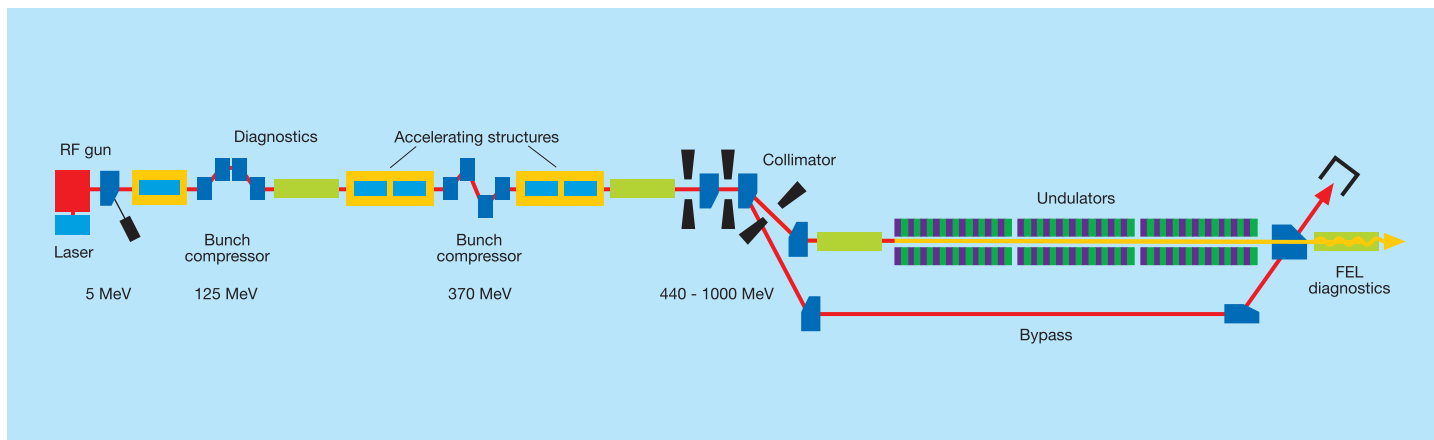

Schematic view of the FLASH facility. The beam is accelerated to a maximum energy of 1 GeV in six accelerator modules, each containing eight superconducting cavities. Two magnetic chicanes are installed for longitudinal bunch compression. A collimator removes the beam halo which might cause radiation damage in the permanent magnets of the undulator.

with magnetic bunch compressors. It would be impossible to recirculate these ultrashort electron bunches through a storage ring without disrupting the charge distribution.

## The free-electron laser FLASH

The free-electron laser FLASH at DESY has produced ultrashort 10-femtosecond pulses of extreme-ultraviolet radiation with wavelengths down to 13 nm, and after an upgrade in 2007 the wavelength will be pushed down to 6.5 nm and into the soft X-ray regime.

In FLASH the electron bunches are produced in a laser-driven photoinjector and accelerated to energies between 440 and 700 MeV by a superconducting linac, and after the upgrade the energy will be raised to 1 GeV. The bunch charge is 0.5 to 1 nC. At intermediate energies of typically 125 MeV and 370 MeV the electron bunches are longitudinally compressed, thereby increasing the peak current from initially 50 A to several 1000 A as required for the FEL operation. The radiation is produced in a 27-m-long undulator. Finally, a dipole magnet deflects the electron beam into a dump, while the FEL radiation propagates to the experimental hall.

## The electron source

The high charge density in the bunches that is needed in a SASE FEL can be accomplished with photocathodes illuminated with short ultraviolet laser pulses. The injector

at FLASH consists of a laser-driven photocathode mounted inside a Radio-Frequency (RF) cavity. The cathode is made of molybdenum and coated with a thin Cs<sub>2</sub>Te layer to achieve a quantum efficiency for photoelectron emission of typically 5 percent.

The UV laser pulses are generated in a mode-locked solid-state laser system (Nd:YLF) built by the Max Born Institute, Berlin. A difference to conventional cathodes is the rapid acceleration to relativistic energies which can only be achieved with radio-frequency fields and not with a dc electric field. The accelerating field at the cathode is in the order of 40 MV/m. A magnetic solenoid field is superimposed to force the particles on helical trajectories around the magnetic field lines in order to preserve a small beam cross section. The pulsed UV laser is synchronized to the 1.3-GHz RF of the linac with a precision of better than 100 femtoseconds.

It is impossible to generate the high peak current immediately in the gun because then huge space charge forces would arise and immediately disrupt the bunch due to the fact that the negatively charged electrons repel each other. Therefore modestly long laser pulses of 10 picoseconds duration are used, leading to a peak current of typically 50 A, but even in this case the particles must be accelerated as quickly as ever possible to relativistic energies. In the relativistic regime the repulsive electric forces between the equal charges are largely cancelled by the attractive magnetic forces between the parallel currents. >

## The quality factor of a cavity

The quality factor of a cavity is defined as the ratio of the resonance frequency to the width of the resonance curve:  $Q_0 = f_0 / \Delta f$ . It is inversely proportional to the surface resistance and amounts to  $Q_0 > 10^{10}$  for niobium cavities at 2 K. In principle the quality factor should stay constant when the field in the cavity is raised from zero to an upper limit which is reached when the radio-frequency magnetic field approaches the critical magnetic field of the superconductor. For niobium at 2 K the critical field is  $B_c \approx 200 \text{ mT}$ , corresponding to a maximum accelerating field  $E_{acc} \approx 45 \text{ MV/m}$ . In practice, however, the excitation curve  $Q_0 = Q_0(E_{acc})$  usually ends at a lower field due to "dirt effects" such as contamination of the inner cavity surface or field emission of electrons. By applying the cleanroom techniques of the semiconductor industry during the assembly and preparation of the cavities one can almost achieve the physical limit of the superconducting material.

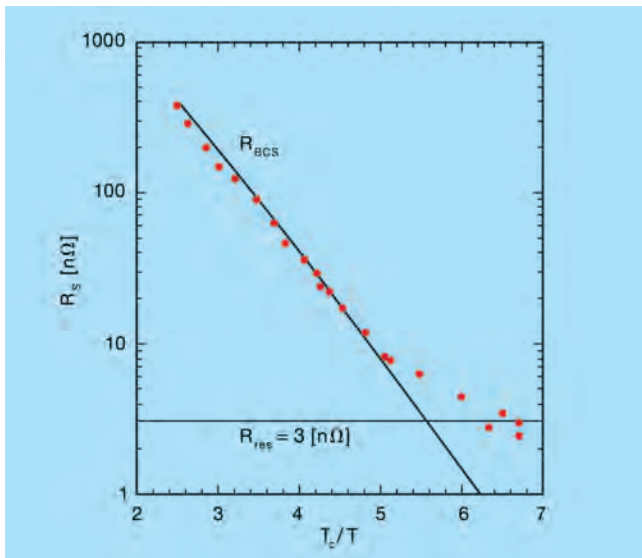

The measured niobium surface resistance in a nine-cell superconducting cavity plotted as a function of  $T_c / T$ . Here  $T$  is the temperature of the helium bath and  $T_c = 9.2 \text{ K}$  the critical temperature of niobium. The residual resistance of  $3 \text{ n}\Omega$  corresponds to a quality factor  $Q_0 = 10^{11}$ .

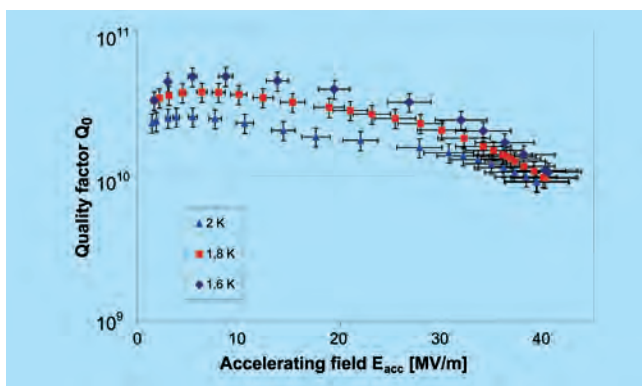

The quality factor of the best cavity as a function of the accelerating field  $E_{acc}$ . The data were taken at helium temperatures between 1.6 and 2.0 K. In the linac of FLASH the cavities are operated at about 15 - 20 MV/m, far below their limit.

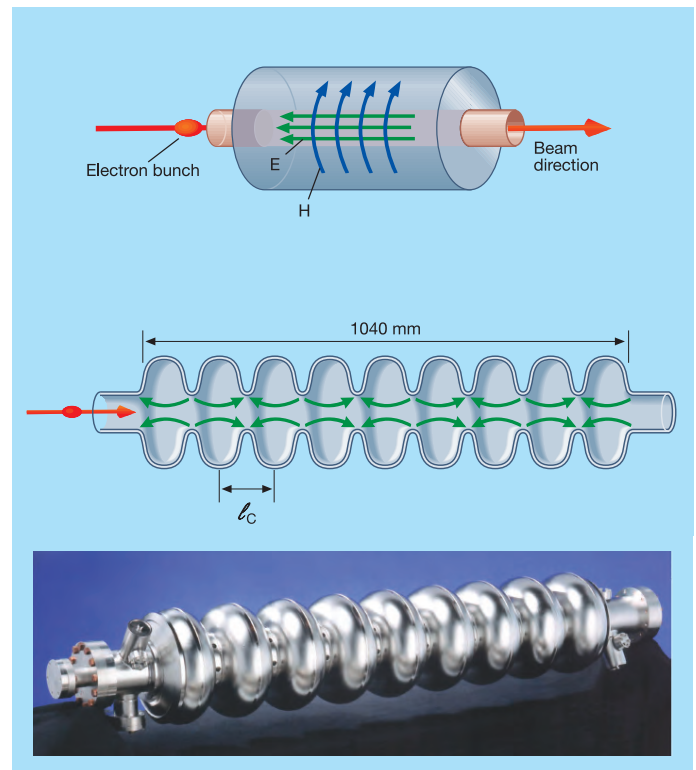

Top: a cylindrical cavity with longitudinal electric field for particle acceleration. The magnetic field lines are concentric circles around the axis. Bottom: longitudinal cut and photo of the nine-cell superconducting cavity, which is made from pure niobium and cooled by superfluid helium of 2 K. The resonance frequency is  $f_0 = 1.3 \text{ GHz}$ . The electric field lines are shown at the instant when an electron bunch has just entered the first cell. The length  $l_c$  of a cell is chosen such that the field direction has inverted when the relativistic bunch has moved to the next cell. This is fulfilled for a cell length equal to half the radio-frequency wavelength,  $l_c = c / (2f_0)$ . Thereby it is ensured that the particles receive the same energy gain in each cell.



Preparation of the superconducting cavities in the DESY cleanroom: A string of eight cavities, each welded into its own liquid-helium tank, is being assembled and prepared for installation in an acceleration module. On the right: a single nine-cell cavity equipped with vacuum flanges and a radio-frequency input coupler for the performance test in a liquid-helium bath cryostat.

## The superconducting linear accelerator

The electron injector section is followed by five 12-meter-long accelerator modules containing eight superconducting cavities each. The cavities are made from pure niobium and consist of nine cells. An important property of superconductors is that their resistance does not vanish in alternating electromagnetic fields, in contrast to the direct current case. In a microwave cavity the oscillating magnetic field of the RF wave penetrates into the superconductor to a depth of about 50 nm and induces forced oscillations of those electrons which are not bound in superconducting pairs. The microwave surface resistance is many orders of magnitude smaller than in normal copper cavities but is nevertheless responsible for non-negligible Ohmic heat generation at the inner cavity surface. The heat must be guided through

the cavity wall into the liquid-helium bath. It constitutes a significant heat load on the helium refrigerator.

The exponential dependence of the resistance on temperature, predicted by the Bardeen-Cooper-Schrieffer (BCS) theory, is observed over a wide temperature range. Below 2 K one observes a residual resistance of a few n $\Omega$  caused by surface impurities. In the XFEL an accelerating field of more than 15 MV/m is needed to reach an FEL wavelength below 0.1 nm. Although the quality factor exceeds the excellent value of  $10^{10}$ , the RF energy dissipation in the cavity walls would be far too large for the liquid-helium plant if the cavities were operated in continuous mode. The necessary reduction of the cryogenic load by about a factor of 100 is the only – and unfortunate – reason to operate the cavities in pulsed mode with a duty cycle of 0.01. >



Photo of a FLASH undulator magnet. The gap height is 12 mm, the period is  $\lambda_u = 27$  mm and the peak magnetic field is  $B_0 = 0.47$  T.

## Bunch compression

High peak currents of several 1000 A are needed in extreme-ultraviolet and X-ray free-electron lasers. These cannot be produced directly in the electron gun. Therefore moderately long bunches with a peak current of about 50 A are created in the source, quickly accelerated to higher energy and then compressed in length by two orders of magnitude.

The electrons in the linac have speeds very close to the speed of light, and the velocity differences are far too small for a trailing electron to catch up with a leading electron if the particles move on a straight line. This possibility is opened if the particles are passed through a magnetic chicane. Longitudinal bunch compression is achieved in two steps. First an energy slope is imprinted on the bunch by acceleration on the falling slope of the RF wave. Consequently the particles at the head of the bunch receive a smaller energy gain than those at the tail. Afterwards the particles pass through two magnetic chicanes where the trailing electrons of larger energy travel a shorter distance than the leading ones of smaller energy and thus are enabled to catch up.

To realize the energy slope, the RF phase in the first accelerator module is adjusted in such a way that the particles are accelerated on the slope of the RF wave. Due to the cosine shape of the RF wave, adding a nonlinear term to the position–energy relationship inside the bunch, and due to coherent synchrotron radiation effects in the magnetic chicanes, the final bunches do not possess the ideal narrow shape but consist of a leading spike with a width of less than 100 femtoseconds and a tail extending over several picoseconds. The leading spike contains 10 to 20 percent of the total bunch charge and reaches a peak current in excess of 1000 A which is needed in the high-gain FEL process. In the long tail, the local current is too small to expect any significant FEL gain. Work is in progress to supplement the 1.3-GHz cavities with a 3.9-GHz cavity that will linearize the RF wave. With this third-harmonic cavity in operation it should be possible to squeeze almost the entire bunch charge into a narrow pulse.

## The undulator magnet

The undulator is a long periodic arrangement of short dipole magnets with alternating polarity. The undulators at FLASH are made from iron pole shoes with NdFeB permanent magnets in between. To achieve FEL saturation in a single pass the undulator must be more than 20 m long for wavelengths in the 10-nanometer regime. The FLASH undulator system consists of six magnets of 4.5 m length each.

In the 60-cm space between the segments, quadrupole lenses are installed for beam focusing alongside beam diagnostics tools. An excellent field quality has been achieved in the undulator, the deviation of the electrons from the ideal orbit is less than 10  $\mu\text{m}$ . This ensures a good overlap between the electron beam and the light wave, which is a prerequisite for achieving a high gain in the lasing process. >

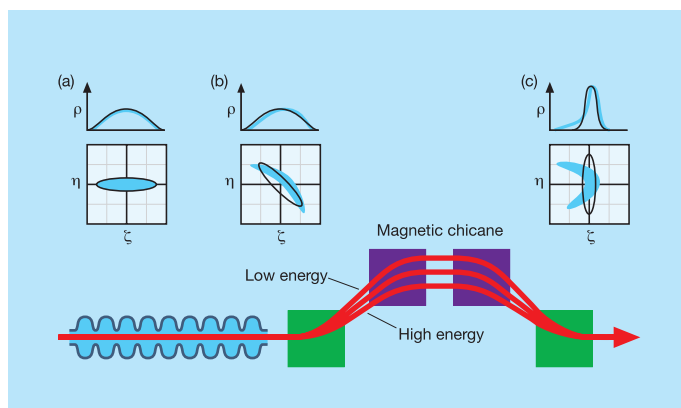

Principle of longitudinal electron bunch compression. The bottom row shows an accelerating cavity and the four dipole magnets of the magnetic chicane. The top figures show the bunch shape at various stages and the correlation between the internal position  $\zeta$  of an electron inside the bunch (and the charge density  $\rho$ , respectively) and its relative energy deviation  $\eta = (W - W_r)/W_r$ , where  $W_r$  is the energy of a reference particle at the centre of the bunch: (a) before the cavity, (b) behind the cavity, (c) behind the magnetic chicane. In the RF cavity the particles are accelerated on the falling slope of the RF wave. Thereby the trailing electrons receive a larger energy gain than the leading ones. In the magnetic chicane the electrons at the tail move on a shorter orbit than those at the head and catch up. The ideal linear energy–position correlation (chirp) is indicated by the black curves, the real nonlinear chirp results in the blue curves and the blue-shaded areas.

# The physics of free-electron lasers

## Wavelength of undulator radiation

The electron moves with a speed  $v < c$  on a wavelike orbit through the undulator. The velocity component  $v_z$  along the  $z$  axis is smaller than  $v$ :

$$v_z = c \left( 1 - \frac{2 + K^2}{4\gamma^2} \right)$$

If one computes the relativistic Doppler shift with this reduced velocity one finds the important formula for the wavelength of undulator radiation in the forward direction:

$$\lambda_\ell = \frac{\lambda_u}{2\gamma^2} \left( 1 + \frac{K^2}{2} \right)$$

The quantity  $K$  is called the undulator parameter

$$K = \frac{eB_0\lambda_u}{2\pi m_0 c} \approx 1$$

It depends on the peak magnetic field  $B_0$  in the undulator and on the undulator period  $\lambda_u$ .

## Low-gain and high-gain FEL

In the low-gain FEL the light wave co-propagating with the relativistic electron beam is described by a plane electromagnetic wave

$$E_x(z, t) = E_0 \cos(k_\ell z - \omega_\ell t) \text{ with } k_\ell = \omega_\ell / c = 2\pi / \lambda_\ell$$

The time derivative of the electron energy  $W = \gamma m_0 c^2$  is

$$\frac{dW}{dt} = \vec{v} \cdot \vec{F} = -e v_x(t) E_x(t)$$

One can show that the condition for sustained transfer from electron to light wave leads to exactly the same wavelength as in undulator radiation:

$$\lambda_\ell = \frac{\lambda_u}{2\gamma^2} \left( 1 + \frac{K^2}{2} \right)$$

To achieve light amplification in a low-gain FEL, the electron energy must exceed the resonance energy

$$W > W_r \equiv \gamma_r m_0 c^2$$

where the resonant Lorentz factor is defined by

$$\gamma_r = \sqrt{\frac{\lambda_u}{2\lambda_\ell} \left( 1 + \frac{K^2}{2} \right)}$$

This means that electrons with this Lorentz factor would emit undulator radiation of exactly the incident wavelength  $\lambda_\ell$ .

The power gain length depends on peak current, electron beam emittance  $\varepsilon$  and beta function  $\beta$  in the form

$$L_g = C \left( \frac{\gamma \varepsilon \beta}{I_{peak}} \right)^{1/3} \text{ with } C = \frac{1}{\sqrt{3}} \left( \frac{2m_0 c \lambda_u}{\mu_0 e K^2} \right)^{1/3}$$

If the FEL is seeded by an incident light wave of field amplitude  $E_0$  and power  $P_0$  the FEL power grows as

$$P(z) = \frac{P_0}{9} \exp(z / L_g) \text{ for } z \geq 2L_g$$

This is theoretically well understood and due to the fact that the field of the light wave obeys a third-order differential equation which has three independent eigenfunctions: the first one is exponentially growing, the second one is exponentially decaying, and the third one is oscillating along the undulator axis. At the entrance to the undulator the field amplitude of the light wave can be expressed as a linear superposition of the three eigenfunctions with equal coefficients. After two gain lengths the first eigensolution starts to dominate and determines the exponential rise.

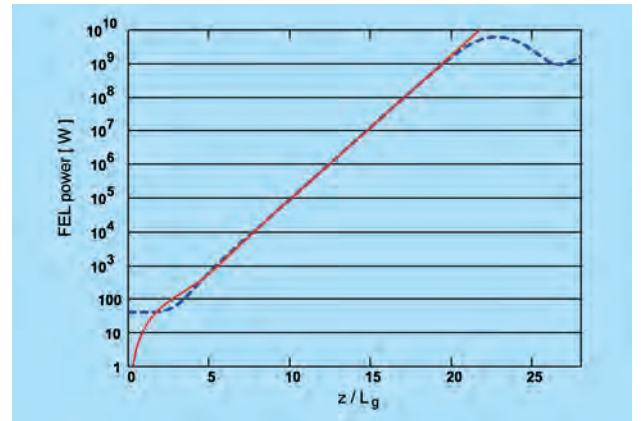

Computed light power as a function of  $z/L_g$  in a SASE FEL (continuous red curve), in comparison with the power rise in a seeded FEL (dashed blue curve).

## BCS surface resistance

According to the Bardeen-Cooper-Schrieffer (BCS) theory of superconductivity the microwave surface resistance depends exponentially on temperature

$$R_{BCS} = A \frac{f_0^2}{T} \exp\left(-\frac{\Delta}{k_B T}\right)$$

Here  $\Delta = 1.76 k_B T_C$  is the energy gap,  $k_B$  the Boltzmann constant,  $T_C$  the critical temperature,  $f_0$  the microwave frequency, and  $A$  a coefficient that depends on the London penetration depth and other material properties. The exponential temperature dependence is the reason why the high-field cavities are cooled with superfluid helium at 2K ( $R_{BCS} \approx 10 n\Omega = 10^{-8} \Omega$ ) instead of using pressurized normal liquid helium at 4.4 K ( $R_{BCS} \approx 1000 n\Omega$ ).

The BCS surface resistance scales quadratically with the radio frequency  $f_0$ , hence it is advantageous to build superconducting cavities with low resonance frequency. The value of 1.3 GHz is a good compromise between low surface resistance and manageable size of the cavities.

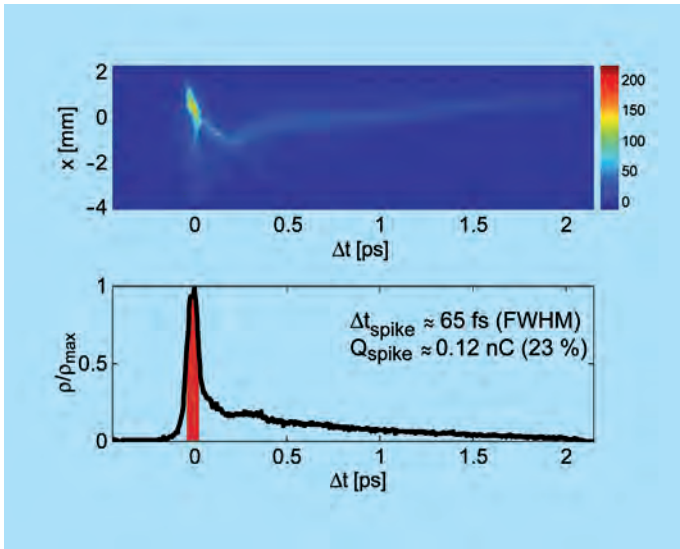

Top: two-dimensional CCD image of a single electron bunch whose time profile is translated into a horizontal coordinate on an observation screen. The head of the bunch is at the left side. Bottom: a computed temporal charge profile as function of time. One observes a sharp peak at the head with a full width at half maximum of 65 femtoseconds, followed by a long tail. The sharp peak contains about 20 percent of the bunch charge; only here the local charge density is high enough to obtain a large gain in the SASE process.

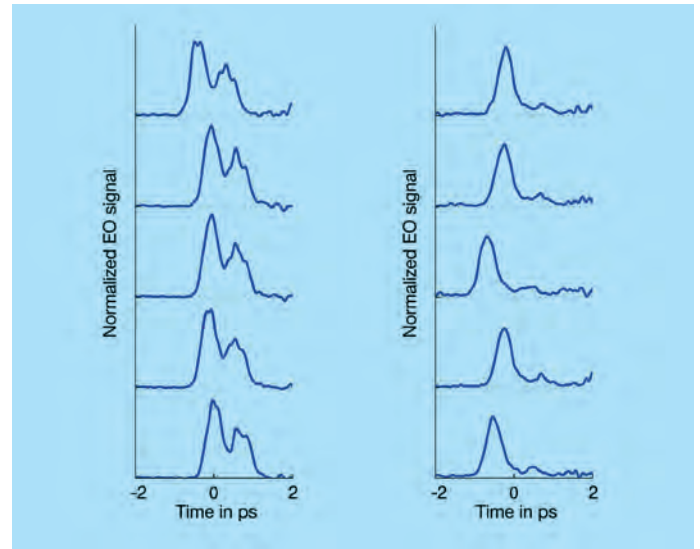

Pulse shape of single electron bunches measured with the spectral decoding method. Left column: wrong RF phase in the first accelerator module. The bunches develop a double peak structure. Right column: correct RF phase, leading to optimum compression of the bunch.

## Electron beam diagnostics

The requirements on electron beam quality are very demanding and in some cases at the limit of present-day technology. High-resolution diagnostic instruments are essential for a detailed understanding of the physical principles of emittance preservation, bunch compression and lasing in the SASE mode. We restrict ourselves here to a description of two techniques permitting single-shot direct visualization of longitudinal electron bunch profiles: Transverse Deflecting Structures (TDS) and Electro-Optic (EO) detection systems.

In the TDS the temporal profile of the electron bunch is transferred to a spatial profile on a view screen by a rapidly varying electromagnetic field, analogous to the sawtooth voltage in conventional oscilloscope tubes. The TDS at FLASH is a 3.6-m-long traveling-wave structure operating at 2.856 GHz, in which a combination of electric and magnetic fields produces a transverse kick for the electron bunches. The bunches pass the TDS near zero crossing of the RF field and receive no net deflection but are streaked in the transverse direction. A single bunch out of a train can be streaked. With a fast kicker magnet, this bunch is deflected towards a view screen that is photographed by a CCD camera. The other electron bunches are not affected.

The electro-optic effect offers the possibility to measure the longitudinal charge distribution in the electron bunches with

50- to 100-femtosecond resolution. The principle is as follows: The electric field of the relativistic bunch induces an optical birefringence in a crystal such as gallium-phosphide, which is then probed with femtosecond titanium-sapphire laser pulses. One EO experiment is installed in the FLASH linac between the last accelerator module and the undulator. The linearly polarized laser pulse acquires an elliptical polarization in the crystal which is converted into an intensity modulation. Single-shot measurements of individual bunches are possible by spectral, temporal or spatial decoding methods. These data are very useful for accelerator diagnostics. For instance, wrong parameters in the bunch compression scheme are immediately visible from the reconstructed bunch shape.

The EO experiment has a lower time resolution than the TDS but has the advantage of being non-destructive: The same bunch which has been analyzed with the EO system can be used to generate FEL radiation downstream. Moreover, the EO signals can be utilized as arrival time signals of the FEL pulses in pump-and-probe experiments.

Detailed information on how the precise timing of femtosecond pump-and-probe pulses is achieved at FLASH is presented in the next chapter which describes the user facility in the experimental hall, while the then following chapter on the first experimental results includes an elegant experiment showing that the two extremely short pulses do in fact overlap in space and time. ●

# THE USER FACILITY.

From the source  
towards the experiments

The FLASH experimental hall starts 30 meters behind the last dipole magnet that separates the electron bunches and the photon beam emerging from the long undulator in the accelerator tunnel. The photon beam transport system in the hall delivers the FEL pulses – as short as 10 femto-seconds – to the experimental stations.

FLASH is a unique source of extremely bright, coherent, and ultrashort pulses of extreme-ultraviolet radiation and soft X-rays enabling researchers to explore the temporal evolution of physical, chemical, and biochemical processes happening in femtoseconds or picoseconds.

## The photon beam transport system

The femtosecond FEL pulses emerge from the undulator in the accelerator tunnel and can be delivered to five experimental stations by the photon beam transport system operating under high vacuum conditions. In order to make efficient use of the FEL radiation, it can be steered to different experimental stations just by switching one or two plane mirrors by remote control. However, presently only one experimental station can be served at a time.

The FEL pulses are switched between the beamlines by 0.5-m-long plane mirrors reflecting the beam at grazing incidence angles of two and three degrees. The FEL optics system has been designed to avoid the risk of damage due to the immense peak powers and to minimize deformation of the mirrors at long bunch trains, i.e. high average power. The mirrors consist of cooled silicon substrates with high-density

carbon coatings, which are superior to other materials in the spectral range of FLASH. These coatings are characterized by a high reflectivity between 94 and 96 percent for energies below 200 eV, and a low surface roughness of less than 0.5 nm over the full mirror length.

## The five beamlines

The experimental stations at the beamlines BL1, BL2 and BL3 utilize the direct FEL pulses. When entering the experimental hall, the FEL beam has a width of about 3 - 5 mm. To focus the beam, BL1 is equipped with a toroidal mirror, while ellipsoidal mirrors are used at BL2 and BL3.

Most users need highly focused and extremely bright FEL pulses, e.g. for experiments in plasma physics, cluster science, and materials research. The mirrors at BL1 and BL2 focus the beam down to spots of approximately 100  $\mu\text{m}$  and 20  $\mu\text{m}$ , respectively. At BL3 the beam can be focused down to a spot of 20  $\mu\text{m}$  as well. However, this beam can also be used unfocused for experiments that do not require a high photon density, or by research groups who prefer to install their own focusing optics. In the latter case a spot size in the range of 1 - 2  $\mu\text{m}$  is reachable with back-reflecting multilayer mirrors.



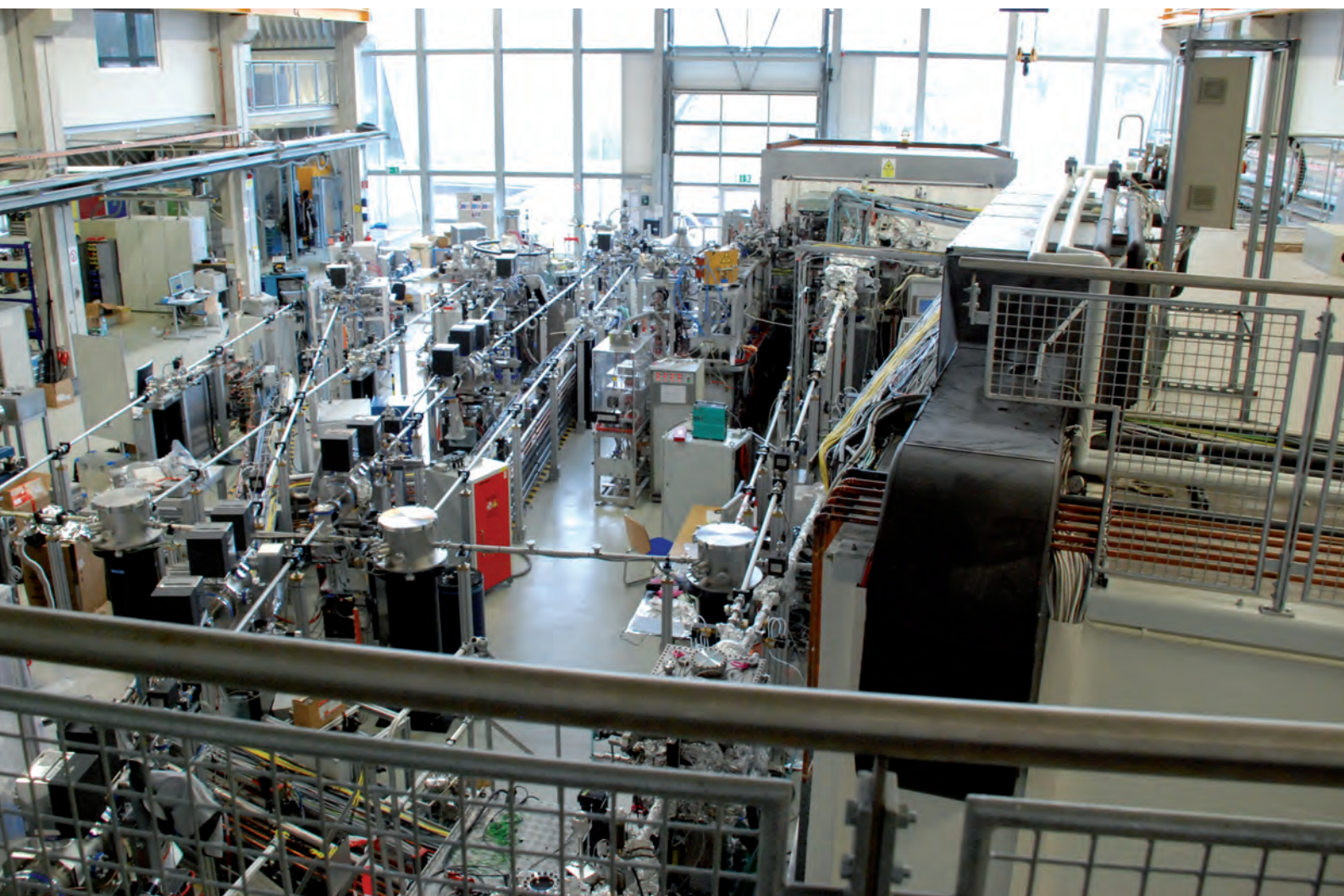

The FLASH photon pulses have an inherent bandwidth of approximately 1 percent, but for many experiments monochromatic radiation is needed, e.g. to study excitation processes in molecules or atoms, and in some pump-and-probe experiments. Thus, a high-resolution plane grating monochromator has been developed to serve the beamlines PG1 and PG2 with FEL pulses of narrower bandwidth.

When the FEL beam hits the grating, a selected wavelength passes through and proceeds to one of these beamlines, while optionally the zeroth order including the higher harmonics is deflected to a special diagnostic port. The monochromator is tunable; by moving the grating and the plane mirror by remote control, different wavelengths can be picked out of the approximately 1-percent FEL bandwidth. An energy range from 20 eV to 1000 eV is covered. The spot size at PG2 is presently about  $100\ \mu\text{m} \times 200\ \mu\text{m}$  depending on wavelength and monochromator settings.

## Intensity and position

Most experiments need online information on the intensity, spectral distribution, and temporal structure of the FEL pulses. This is achieved using non-destructive diagnostic tools operating in parallel. Due to the SASE-specific shot-to-shot fluctuations, pulse-resolved diagnostics are mandatory.

For many users the most important parameter is the intensity, which varies from pulse to pulse. Depending on the operation conditions of the FEL, the energy per bunch, varying from shot to shot, is typically in the range of  $10\ \mu\text{J}$  to  $50\ \mu\text{J}$ . In fact almost all experiments need that information on a shot-to-shot basis. An example are experiments measuring the ablation threshold of a material, which need this in order to analyze and model these processes. The intensity monitors at FLASH have to cover the full spectral range of the FEL beam – from 6.5 nm to 60 nm – as well as the extended dynamic range from spontaneous undulator radiation to SASE in saturation. To accomplish these requirements a state-of-the-art gas monitor detector has been developed. [➤ Page 27](#)

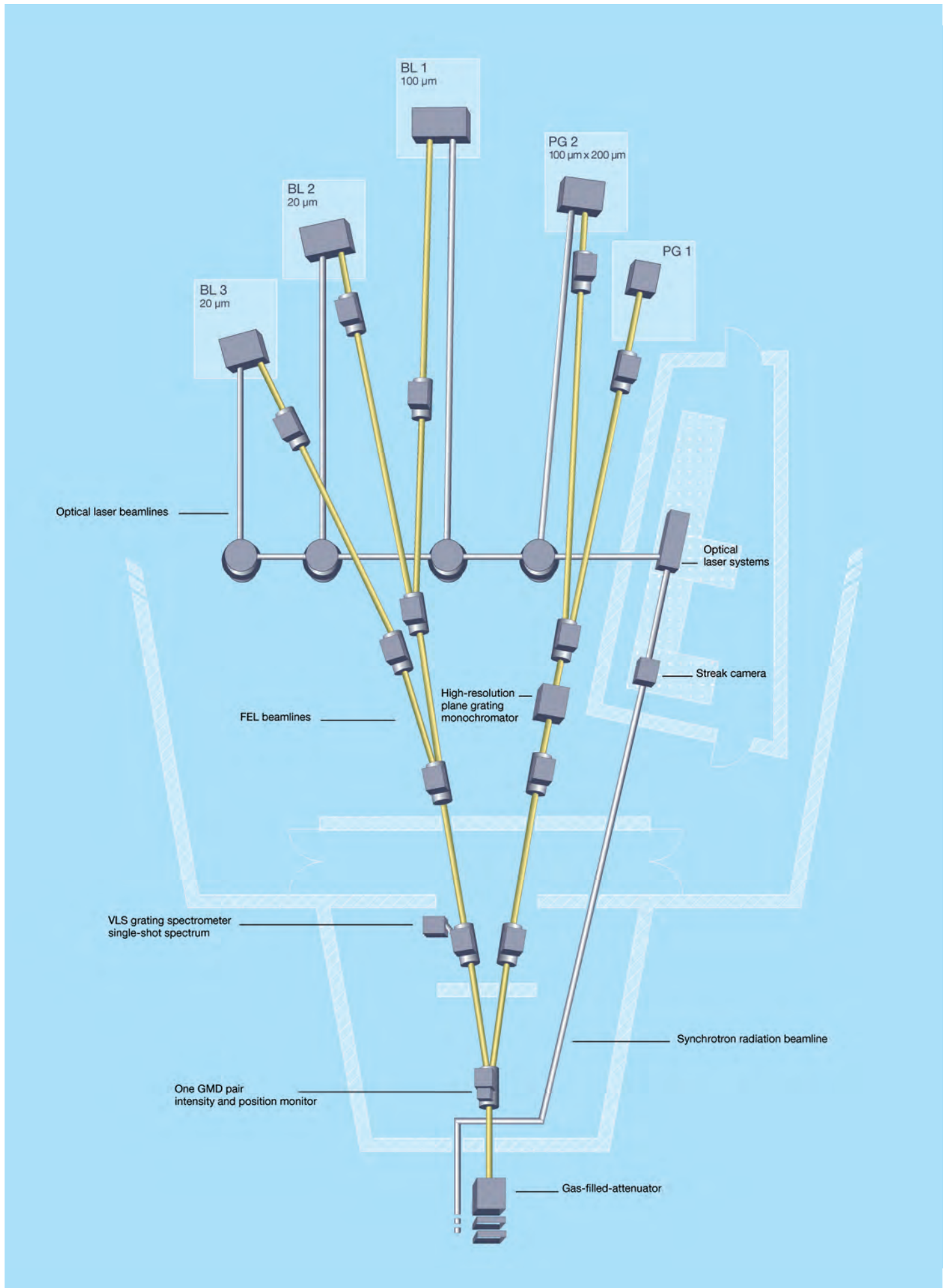

Schematic view of the FLASH experimental hall

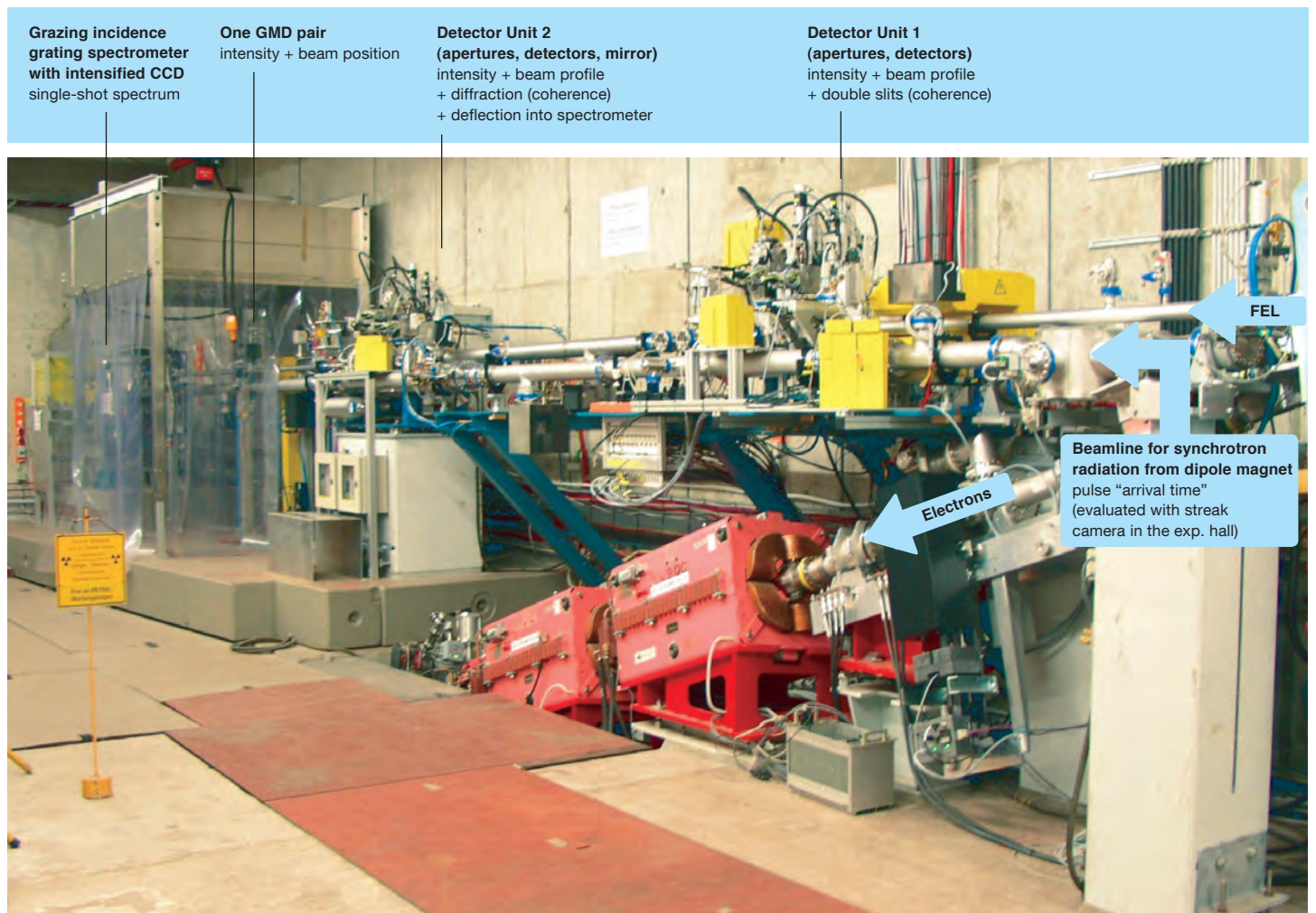

The most important diagnostic units used to optimize the FEL beam are marked.

The detectors measure the intensity, position, spectrum, spatial profile, and arrival time of the FEL pulses.

## Layout of the user facility

The photon beam transport system delivers the FEL pulses to one out of five experimental stations at a time. The beam is switched between stations by remotely controlled plane grazing incidence mirrors.

- > The direct “non-monochromatized” beam is delivered to the beamlines BL1, BL2 and BL3. The beamlines PG1 and PG2 are equipped with a high-resolution monochromator selecting a narrow spectrum of the FEL pulse.
- > The optical laser in the laser hutch is used as a pump source for femtosecond time-resolved pump-and-probe experiments where usually the FEL pulse acts as the probe. The synchronization of these extremely fast pulses is checked by a Timing Electro-Optical sampling (TEO) system placed in the linear accelerator, and by a streak camera that measures the arrival

time of the optical laser pulse and of the synchrotron radiation generated by the electron bunches when they are deflected via a dipole magnet into the dump.

- > The intensity of the FEL pulses varies due to the stochastic nature of the SASE process. Non-invasive measurements of the intensity of individual pulses are performed by four Gas Monitor Detectors (GMD) that also determine the position of each pulse during experiments. The gas monitor detectors are located at the end of the accelerator tunnel and the beginning of the experimental hall.
- > The fluctuations in wavelength – within the FEL bandwidth of approximately 1 percent – from pulse to pulse are specific for the SASE process. Single-shot spectra can be measured by a new Variable Line Spacing grating spectrometer (VLS).

## Ensuring the pointing stability

When setting up the machine after maintenance operations or upgrades, it is crucial to ensure pointing stability of the FEL beam and optimum focusing at the experimental stations. For this purpose a Ce:YAG fluorescent crystal with a laser-engraved cross is incorporated in detector unit 2 in the tunnel. Centering the beam on this cross ensures that it can accurately propagate across all mirrors towards the experiments.

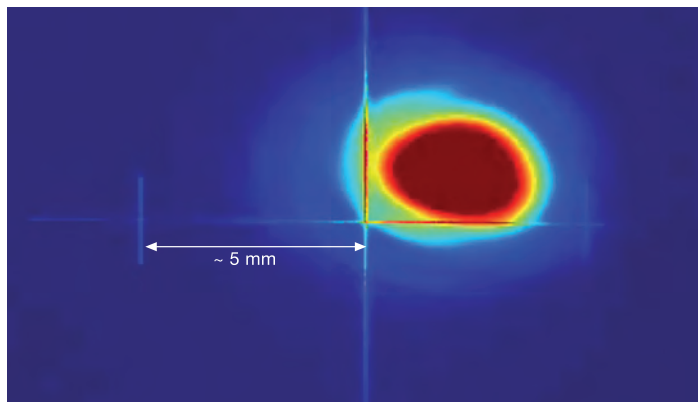

Spatial profile of the FEL beam on the Ce:YAG crystal averaged over 3 bunches. The laser-engraved cross is clearly visible. The average energy in the radiation pulse was 40  $\mu\text{J}$  at a wavelength of 13 nm.

## The gas-filled attenuator

The extremely intense FEL pulses from FLASH may destroy a sample in a single shot. Thus, for aligning delicate samples or determining the intensity dependence of processes without changing the beam characteristics, a windowless gas-filled cell with differential pumping units can be used. The 15-m-long gas-filled attenuator is placed in front of the experimental hall between the two pairs of gas monitor detectors. The maximum gas pressure is about 0.1 mbar. Nitrogen covers a sufficient attenuation range of at least five orders of magnitude in the spectral range of 19 to 60 nm. Between 6.5 and 19 nm xenon and krypton can be used.

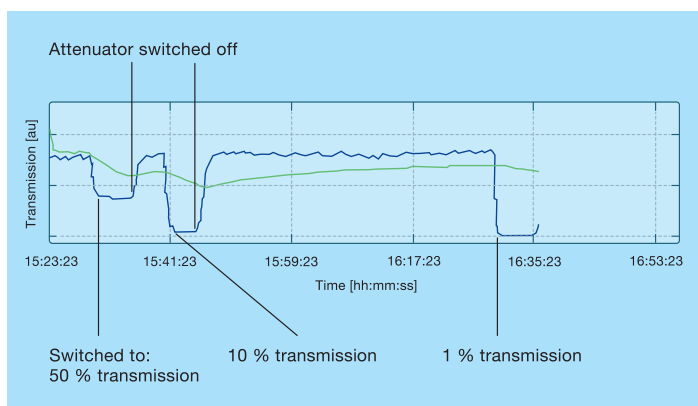

The diagram demonstrates the performance of the attenuator. The blue curve shows the transmission signal in real time, while the green curve displays a time average with a time constant of 30 minutes.

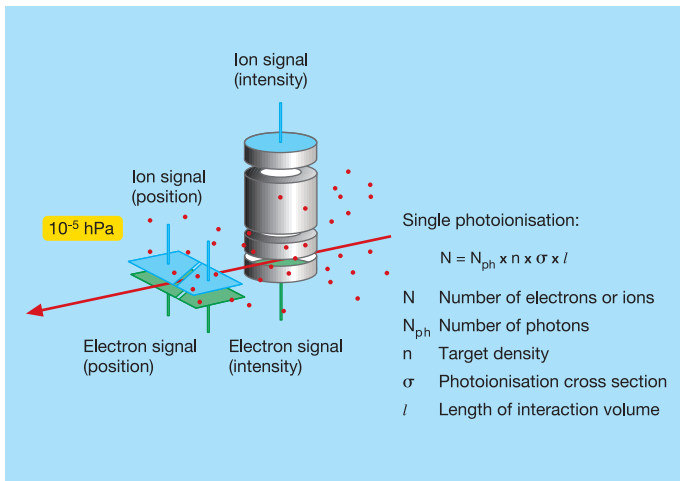

The gas monitor detectors provide non-invasive measurements of the shot-to-shot intensity. To the right: A Faraday cup counts the electrons and ions that are produced as the FEL pulse passes through the ionization chamber containing nitrogen or rare gases at very low pressure. To the left: The two split electrodes determine the horizontal position of the beam.

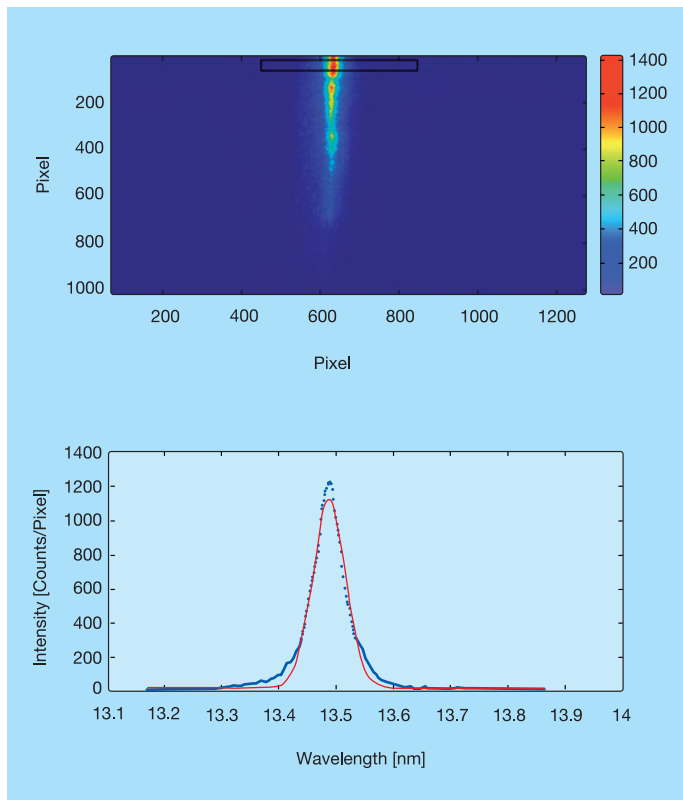

A single-shot spectrum, here with a fundamental wavelength of 13.49 nm

When an FEL pulse passes through the ionization chamber of the detector, the gas inside is ionized, and an electric field accelerates the ions upwards and the electrons downwards to be detected by Faraday cups. From the resulting electron and ion currents the absolute number of photons in each shot can be deduced with an accuracy of 15 percent. Furthermore, the FEL pulse passes in between two split-electrode plates, allowing the pulse-resolved determination of the horizontal and vertical position of the beam.

Two pairs of gas monitor detectors are integrated into the FEL beamline on the way to the experimental hall as permanent intensity and beam position monitors. The gas in the ionization chamber has a very low pressure of some  $10^{-6}$  mbar ( $10^{-5}$  hPa), and it is nearly transparent to the FEL pulse that proceeds unaltered to the experimental stations.

## The spectrum of a single shot

An FEL single-shot spectrum can be measured by a grazing incidence grating spectrometer at the end of the linac tunnel. The grating diffracts the light – depending on wavelength – to different positions on a CCD camera. However, to perform the measurement, a mirror has to be moved into the beam blocking the radiation, and hence these measurements are only carried out for machine commissioning and tuning on user demands.

A new Variable Line Spacing grating spectrometer (VLS) will enable optional online spectral measurements of the FEL pulses actually used for experiments. The blazed grating will replace the second mirror of the FEL beam distribution system with negligible side effects on the downstream beamlines. In this setup about 10 percent of the beam are diffracted and focused by the grating in the first order onto a CCD detector, while the rest of the pulse, reflected in zeroth order, proceeds to the experiment. The spectrometer will cover the wavelength range from 6.5 nm to 60 nm.

## Pump-and-probe experiments

The extremely bright pulses of extreme-ultraviolet radiation and soft X-rays from FLASH can be as short as 10 femtoseconds, corresponding to only 3  $\mu\text{m}$  of optical path length. These ultrashort pulses can be used to explore the temporal evolution of various processes such as atomic motion, phase transitions, expansion of hot plasmas, and chemical reactions.

To measure events happening in femtoseconds or picoseconds, researchers mainly utilize the pump-and-probe technique. Two short pulses are required: The pump pulse starts the reaction, while the probe pulse investigates the state of the system after a defined time delay. A sequence of probe pulses, at different time intervals after a reaction has been initiated by the pump pulse, allows recording a “film” of a molecular reaction. ➤

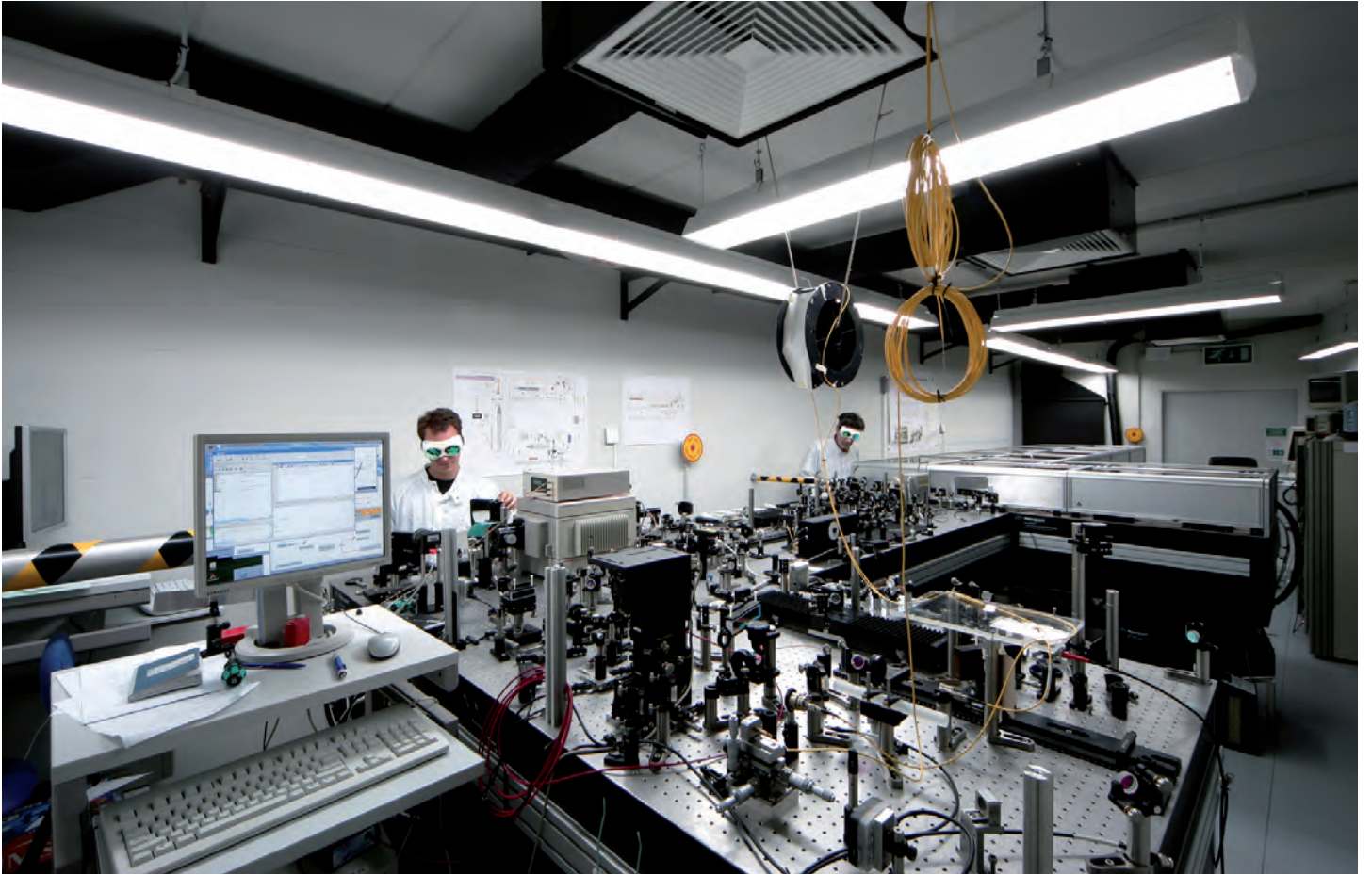

The optical laser system in the laser hutch

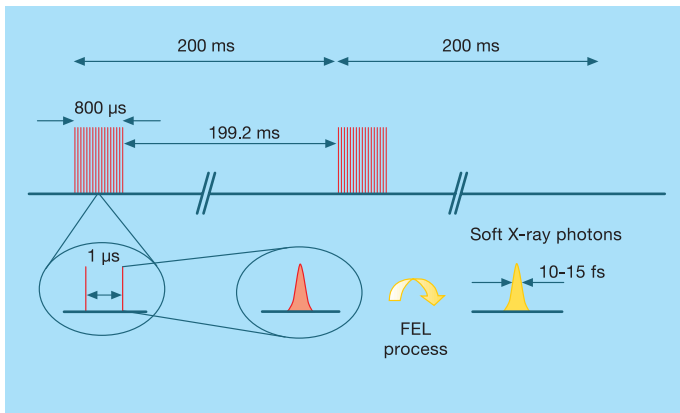

Electron bunch time pattern of FLASH with 5 Hz repetition rate and up to 800 bunches in a 800- $\mu$ s-long bunch train. The separation of electron bunches within a train is 1  $\mu$ s. To a certain extent, the bunch distance in a train can be varied; for instance to 2, 10, or 100  $\mu$ s and some other distances. The duration of the electron bunches is 20 to 100 fs. The nonlinear FEL process reduces the duration of the photon pulses down to 10 - 50 fs.

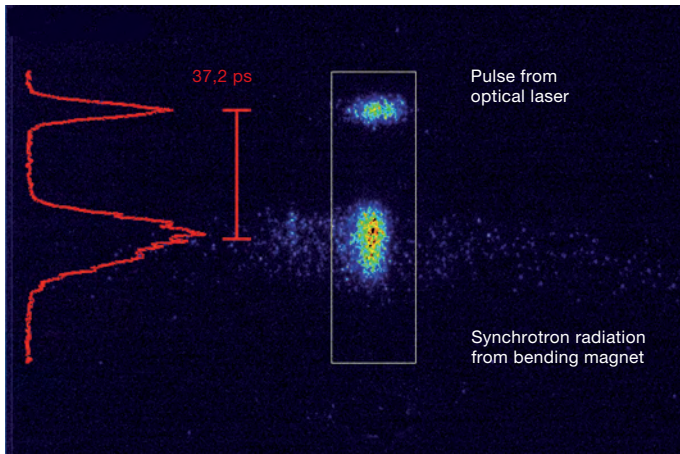

Image of the optical laser pulse and the synchrotron radiation pulse as a reference for the FEL arrival time on the streak camera. The shown time frame is about 140 ps.

Both the pump and the probe pulse could originate from the FEL itself by splitting the pulse in two and delaying one of them by sending it on a longer path. However, an alternative and much more flexible approach is to use an ultrashort pulse from an optical laser as the pump source. With an optical laser, it is much easier to change the wavelength, the polarization, and the angle of incidence, or to expand the pump delay from the femtosecond range up to several nanoseconds.

## Timing the laser and the FEL

Two optical laser systems, both with 100-femtosecond pulses, are used. One mimics the bunch train structure of the FEL with 50  $\mu$ J per pulse and up to 800 pulses per train. The other laser has a pulse energy of 25 mJ with one pulse per bunch train, i.e. a repetition rate of 5 Hz. It is mandatory that the pump and probe pulses overlap each other in time and space. Accuracy of the order of the pulse length of both pulses is desired, and tremendous effort is made to enable stable synchronization and precise measurement of the remaining temporal jitter and drift.

The determination of the jitter between the optical laser and the FEL pulse is essential. Therefore part of the optical laser pulse is reflected to a streak camera recording the arrival time of the pulse. For the timing reference of the FEL pulse the optical portion of a synchrotron radiation pulse is used. This synchrotron radiation pulse is produced when the electrons are deflected in a dipole magnet into the dump. From the image of the streak camera, the relative jitter between both pulses is determined from the peak positions.

An even better temporal resolution on a shot-to-shot basis is achieved by a timing electro-optical sampling system which determines the jitter between the optical laser pulse and the electron bunch directly. In this system some of the optical laser pulses are sent into the accelerator tunnel guided by a glass fiber. Here, the laser pulses pass through an electro-optically active crystal located only a few millimeter away from the electron beam. The laser passes through the crystal with an angle of incidence of 45 degrees. ➤

## The data acquisition and control systems

The control and data acquisition systems for FLASH are based on DOOCS, a Distributed Object-Oriented Control System, and they run on Solaris and Linux machines with an interface to Windows.

The control system of FLASH consists of 900 fast and 500 slow data channels producing up to 100 MByte/s of data depending on the operation mode. The control system functions are divided into a device layer containing servers with a direct connection to hardware, a middle layer for communication between different devices or data processing, and an application level offering not only data display but also other tools like LabView, ROOT, and MATLAB.

The data acquisition system is dedicated to the following tasks: collecting beam-relevant data in real time, providing the data to feedback and monitoring tools as well as storing it for offline analysis. The system provides means for remote machine and beamline operations, and also enables storing user experiments data in parallel streams to make further correlations between the experimental measurements and the state of the accelerator on a bunch-by-bunch basis.

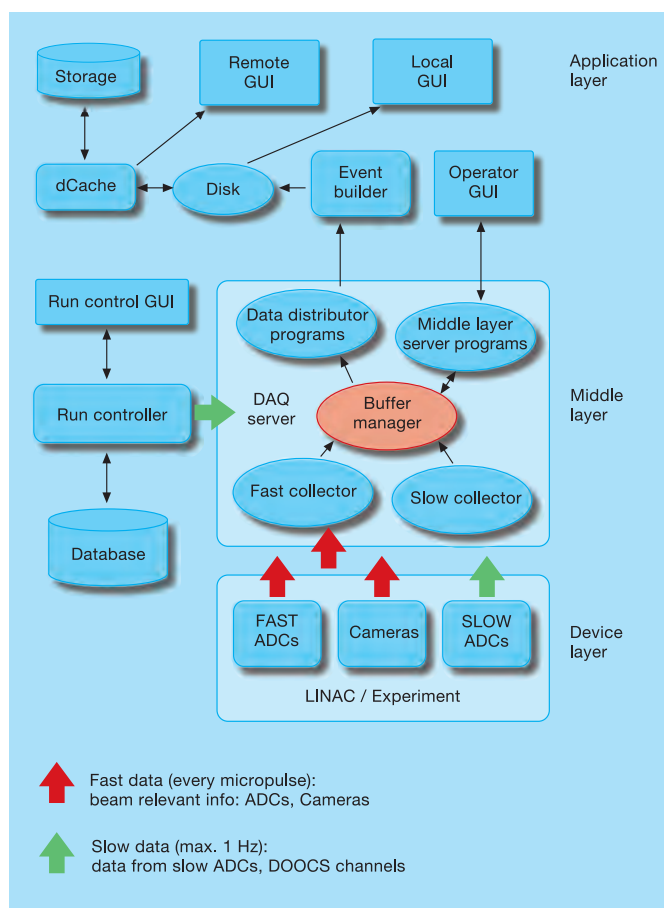

Layout of the data acquisition system (DAQ) for FLASH – similar for the accelerator and the experiments: Currently a SUN work station carrying 16 SPARC processors running at 1.2 GHz, with 32 GB of working memory, 4 x 1-Gbit Ethernet and 1.7-TB local storage is employed as the DAQ server. Temporarily the data is stored on a 24-TB local disc before being sent to the tape storage.



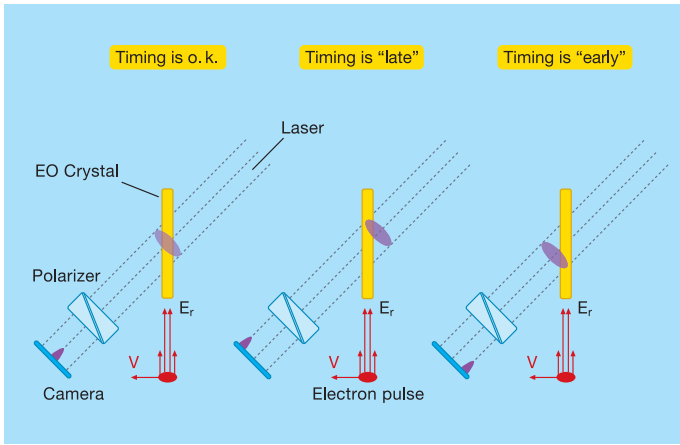

Scheme of the single-shot Electro-Optical (EO) sampling. Due to the 45-degree angle of incidence, the optical laser pulses cross different parts of the crystal at different times. If the laser pulse is later or earlier than the electron bunch, the image on the camera is shifted.

When the electron bunch comes close to the crystal, its electric field induces a change of the birefringence inside the crystal, thus producing an electro-optical effect. If the laser pulse reaches the crystal at exactly the moment when the electron bunch passes the crystal, the polarization of the laser pulse will be turned slightly. Using a polarizer behind the crystal, this phase effect is transformed into an intensity signal, which is monitored by a CCD camera. Due to the mentioned angle of incidence, the optical laser pulses cross different parts of the crystal at different times; hence a mapping of time to space is achieved. If the laser pulse arrives later or earlier than the electron bunch, the image on the camera is shifted. The current time resolution is better than 100 femtoseconds.

The idea of this diagnostic tool is to record the jitter data and provide it to the experimentalists to sort their measured results after the experiment. When using data from timing experiments, the time resolution of pump-and-probe experiments is not determined by the timing jitter anymore, but rather by the accuracy of the jitter measurements. Thus the experiments can be improved by providing a temporal resolution beyond the "jitter limit".

The next chapter on the first experimental results at FLASH presents an overview of the experiments that have been performed in 2005 and 2006 and describes in detail some of the most important results achieved so far. ●

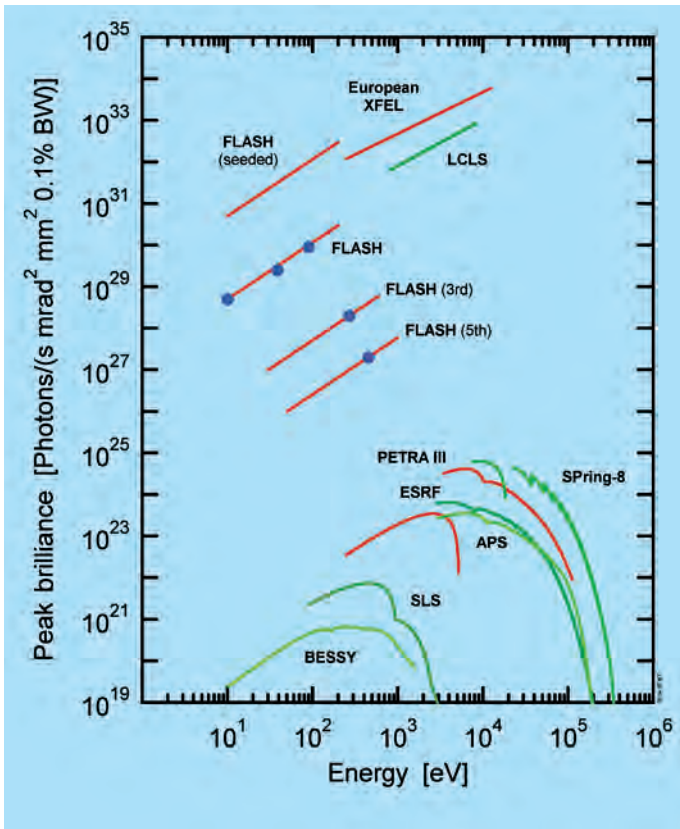

Peak brilliance of FLASH and future FELs (XFEL at DESY, LCLS (USA)) compared with selected 3rd generation synchrotron radiation sources (PETRA III at DESY, Spring-8 (Japan), ESRF (France), APS (USA), SLS (Switzerland), and BESSY (Germany)). DESY facilities are displayed in red, others in green. Blue dots are used for measured values. – The European XFEL will be ready for commissioning in 2013; PETRA III will deliver photons for user operation starting in 2009.

# RESEARCH AND SCIENCE.

## First results and experimental possibilities at FLASH

Both the FLASH facility itself and the user experiments have made tremendous progress during the first two years. Many experiments took promising data and demonstrated the feasibility of new concepts.

Since the first experiments in summer 2005, the operation of the FLASH free-electron laser has already become routine. The stability and reliability of the FEL as well as the average radiation pulse energy have significantly increased, and, according to computer simulations, FEL pulses as short as 10 femtoseconds have been produced. FLASH can now be tuned to any wavelength between 50 and 13 nanometers within a few hours by varying the energy of the accelerator. The demonstration of tunability in spring 2006 was one of the most important milestones for flexible user operation.

### The first experiments

In 2006 and spring 2007, there were 16 active projects involving approximately 200 scientists from 11 countries. Most of the researchers are working in collaborations consisting of several teams, and many of these teams have built new instrumentation dedicated to their experiments at FLASH.

The projects can be grouped into four broad categories:

- Femtosecond time-resolved experiments dealing both with technical developments and the first pump-and-probe experiments.

- Studies of the interaction between extreme-ultraviolet radiation and matter, including experiments dealing with multiphoton excitation of atoms, molecules and clusters. The first diffraction experiments on artificial nano-objects have successfully demonstrated that images can indeed be taken with a single FEL pulse even though the objects explode after the radiation impact. This result is particularly important for research groups aiming to determine the atomic structure of large biomolecules from non-crystalline samples.
- Investigations of very dilute samples. These projects deal with photodissociation of molecular ions, spectroscopy of highly charged ions, and mass-selected clusters.
- Research on surfaces and solids including experiments on laser desorption, surface dynamics, luminescence, Raman and photoelectron spectroscopy of surfaces and solids with nanometer spatial resolution.

22 weeks of beamtime were scheduled for user experiments in 2006. Typically, beamtime is organised in blocks of four weeks, preceded by three weeks of FEL studies for improving the overall performance of the FEL and the user facility. The remaining time was used for maintenance and machine studies.

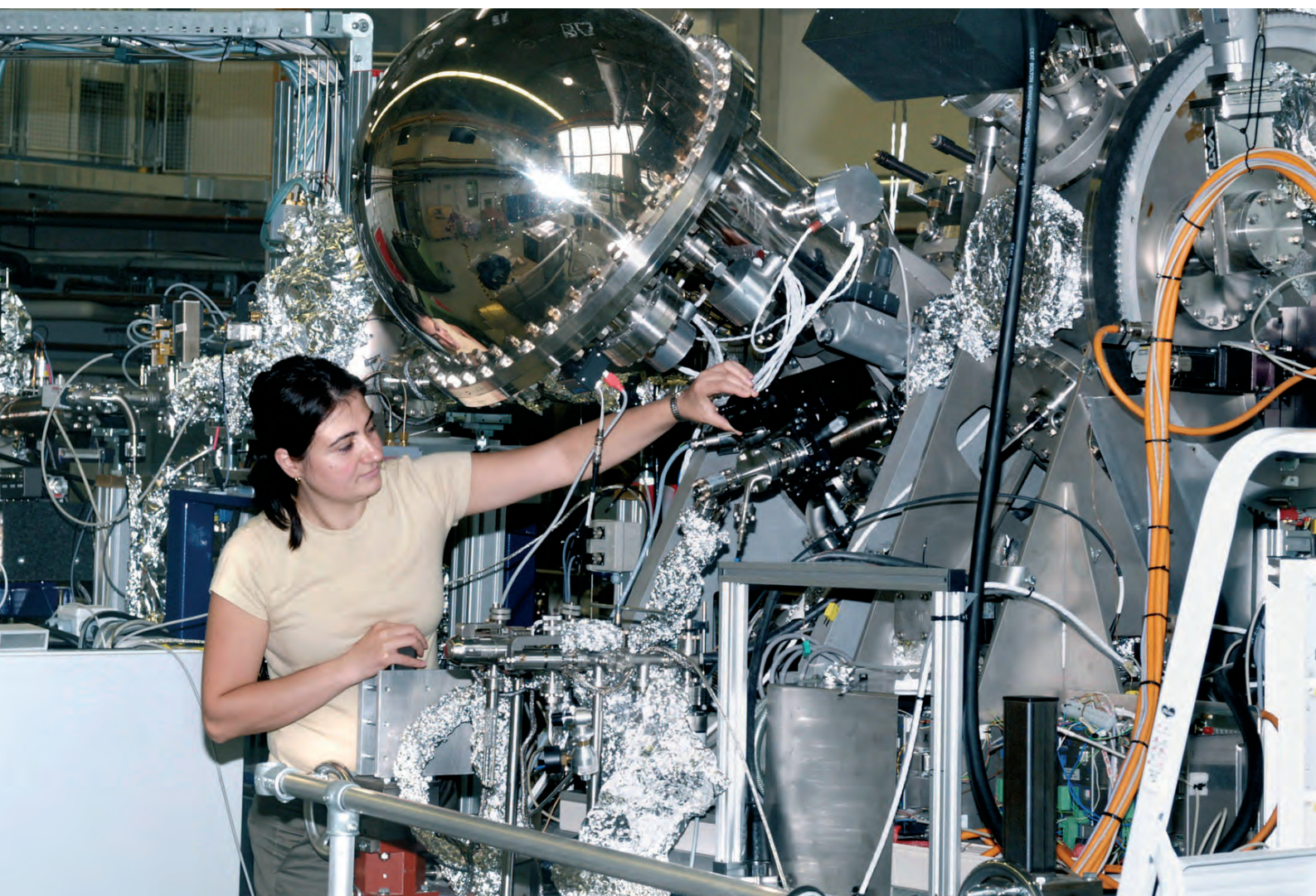

## Performance of the FEL radiation

2005 – 2007

Wavelength range of the fundamental	13 - 47 nm (from fall 2007: 6.5 nm)
Higher harmonics	3rd 4.6 nm 5th 2.7 nm (7th 1.9 nm)
Average pulse energy	up to 100 $\mu$ J
Peak pulse energy	170 $\mu$ J
Peak power	5 GW
Average power	100 mW
Pulse duration	10 - 50 fs
Spectral width	0.5 - 1%
Peak brilliance	$10^{29}$ - $10^{30}$ [photons/(s mrad <sup>2</sup> mm <sup>2</sup> 0.1% BW)]

## The FLASH upgrade in 2007

From April to June 2007, additional cryomodules will be installed in the accelerator enabling the linac to reach its nominal energy of 1 GeV. Lasing in the soft X-ray regime at 6.5 nm is expected for the next round of experiments beginning in fall 2007.

The exciting research possibilities at FLASH attracted many researchers. 45 new proposals were submitted for experiments starting after the upgrade, they cover six different areas: studies of gas phase samples including atoms, molecules and ions; clusters; imaging and diffraction; high-energy density and warm dense matter; surfaces and solids; and technical developments such as commissioning of new instrumentation.

The projects were reviewed by a project review panel with eleven members from six countries, and due to the very high quality only a few projects were rejected. The procedure selected 32 projects sharing two eight-month beamtime periods, each period including 150 twelve-hour shifts to be distributed among the science projects. ➤

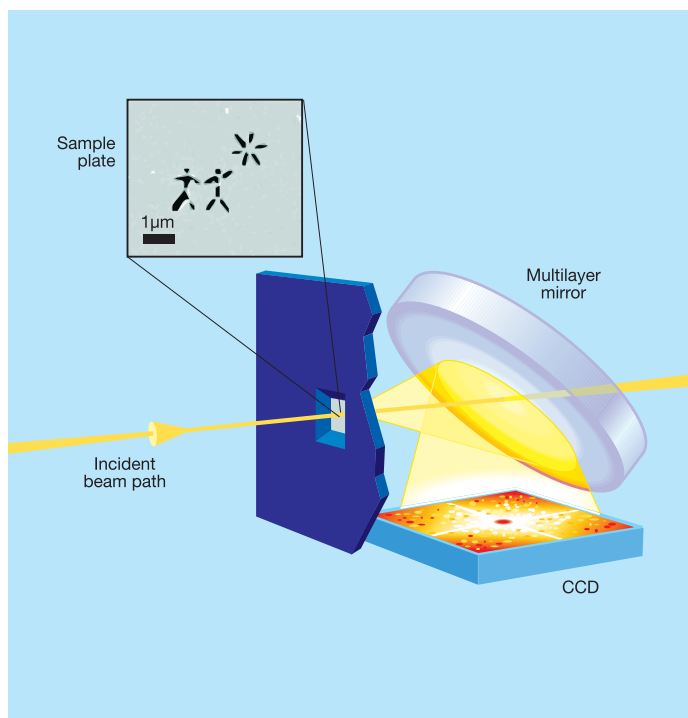

The direct FEL pulse passes through the sample window and exits the camera through a hole in the multilayer mirror. The mirror reflects only the diffracted light from the nanoscale object onto a CCD detector that records a continuous diffraction pattern. An algorithm converts this pattern into an image of the object: two small cowboys in the sun.

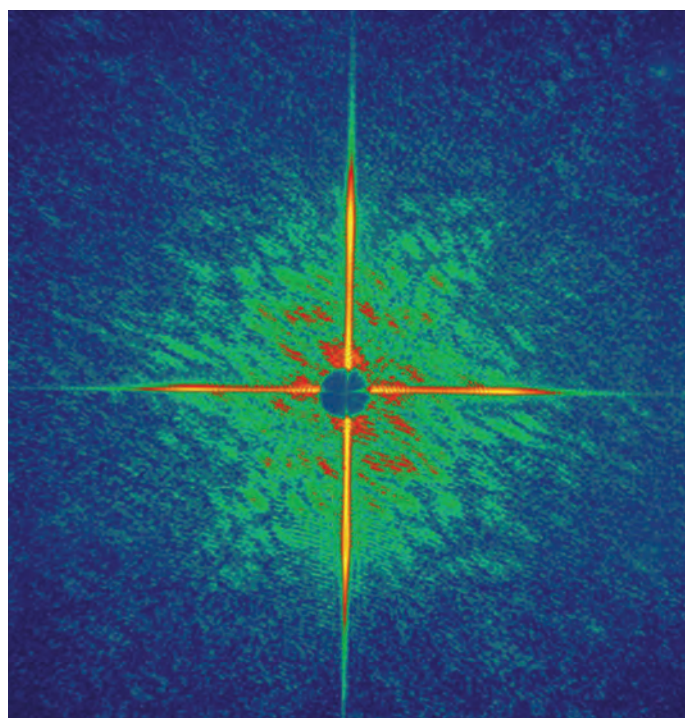

A coherent diffraction pattern of the object recorded from a single 25-femtosecond FEL pulse.

## A perfect image from a single FEL shot

*Theory had predicted it; a model experiment at FLASH delivered the proof of principle. A nanoscale object can be imaged by a single femtosecond FEL pulse before the sample turns into a plasma and explodes.*

One of the key problems facing structural biology is the difficulty in determining the structures of biological macromolecules that cannot be crystallized; some examples are pathogenic viruses such as HIV, and the majority of human membrane proteins, which are the most important drug targets.

Thus, if scientists could use the extremely intense and coherent femtosecond pulses from future hard X-ray FELs to record atomic structures from non-crystalline samples consisting of a few or even single biomolecules, the impact on biological and pharmaceutical research can hardly be overestimated.

But is it really possible to record a diffraction pattern before the powerful radiation destroys the sample? Theoretical

calculations had suggested it, and now a model experiment at FLASH strongly supports the view. This experiment was performed by researchers from Lawrence Livermore National Laboratory, University of California, SLAC, and Spiller X-ray Optics, all in the USA, as well as Uppsala University in Sweden, Technische Universität Berlin, and DESY.

With a single 25-femtosecond FEL pulse the researchers recorded a continuous diffraction pattern of a nanoscale object with a CCD camera before the image-forming pulse destroyed the sample. What is particularly impressive is the fact that a perfect image of the object – two small cowboys – could be reconstructed from this diffraction pattern using an algorithm requiring no *a priori* knowledge about the object.

## Imaging of biological specimens

The research group concludes: “Our apparatus provides a new and unique tool at FLASH to perform imaging of biological specimens beyond the conventional radiation damage limits and to acquire images of ultrafast processes initiated by an FEL pulse or another laser.”

Nevertheless, many obstacles remain before scientists will be able to churn out structures of large biomolecules at atomic

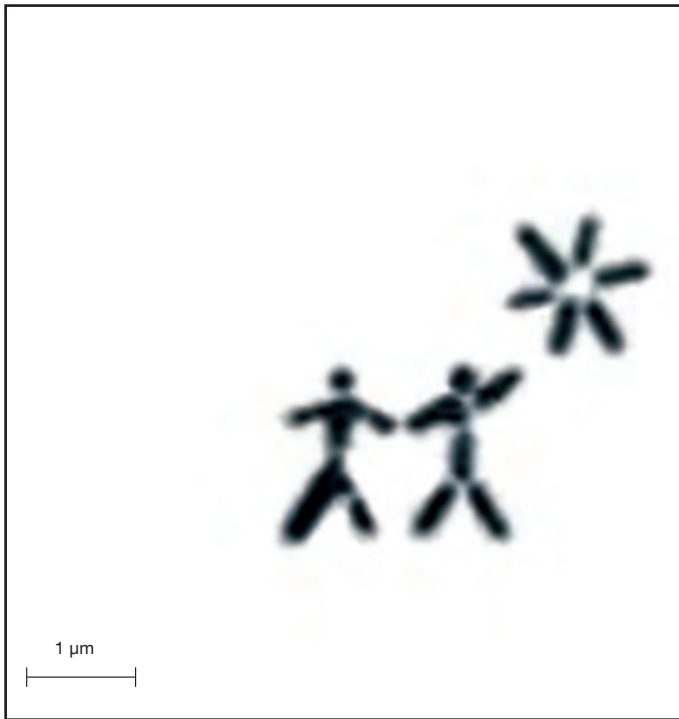

Reconstructed image of the cowboys, which shows no signs of radiation damage caused by the pulse.

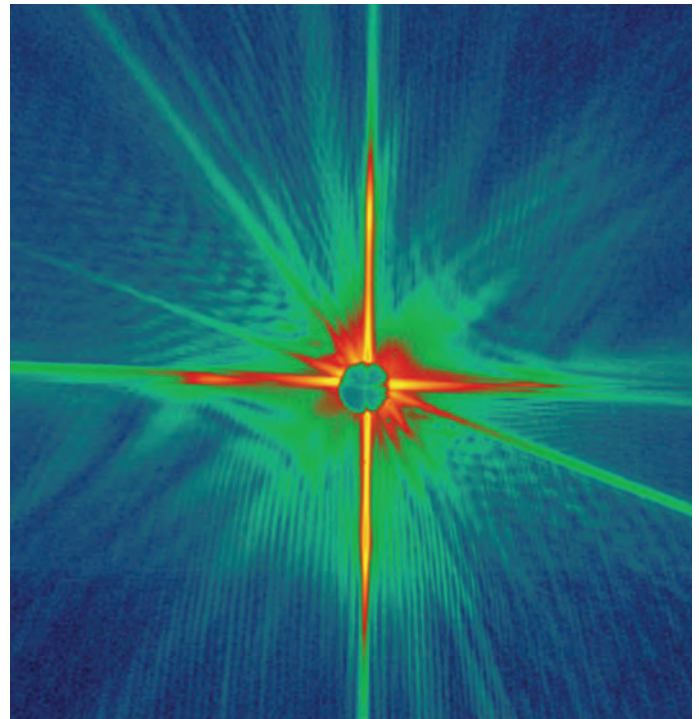

Diffraction pattern from the subsequent pulse showing that the first pulse destroyed the object after recording the image.

resolution. Such atomic structures can only be resolved using hard X-rays from e.g. the planned European XFEL facility and not by the soft X-rays from FLASH. Furthermore, the structure of these macromolecules will have to be stable at near-atomic dimensions during the exposure, and the diffraction patterns will be weaker than in the model experiment. Overcoming these hurdles may not be easy, but the potential payoff, especially in terms of advances in biology, medicine and material science, is certainly worth the effort.

Ultimately structural biologists may be able to uncover the extremely fast steps in biochemical reactions such as enzymatic processes and drug-receptor interactions using the single-shot approach.

The idea is to start a reaction with a pump pulse, e.g. from an optical laser, and to record snapshots of the system with atomic resolution using a femtosecond hard X-ray free-electron laser beam. These snapshots could be taken on reproducible samples at different time intervals after initiation of the reaction and assembled into a molecular movie. Further experiments at FLASH will be indispensable to realize this potential at the European XFEL and its American and Japanese counterparts. >

---

## Coherent diffractive imaging

If the single-shot method can be applied to solve the structures of biological macromolecules at the XFEL, it will have significant advantages compared to the generally applied method using crystals and X-rays from synchrotron radiation sources.

In contrast to macromolecular crystallography where the scattering from many unit cells interferes to give discrete Bragg spots, an exposure of a non-periodic sample to a coherent FEL pulse produces a continuous landscape of peaks and troughs.

This diffraction pattern can be sampled in principle on an arbitrarily fine scale that opens the way for solving the phase problem by iterative algorithms and finally inverting the pattern to yield an image of the object. A three-dimensional data set may be assembled from such images when copies of reproducible samples are exposed to the beam one by one.

---

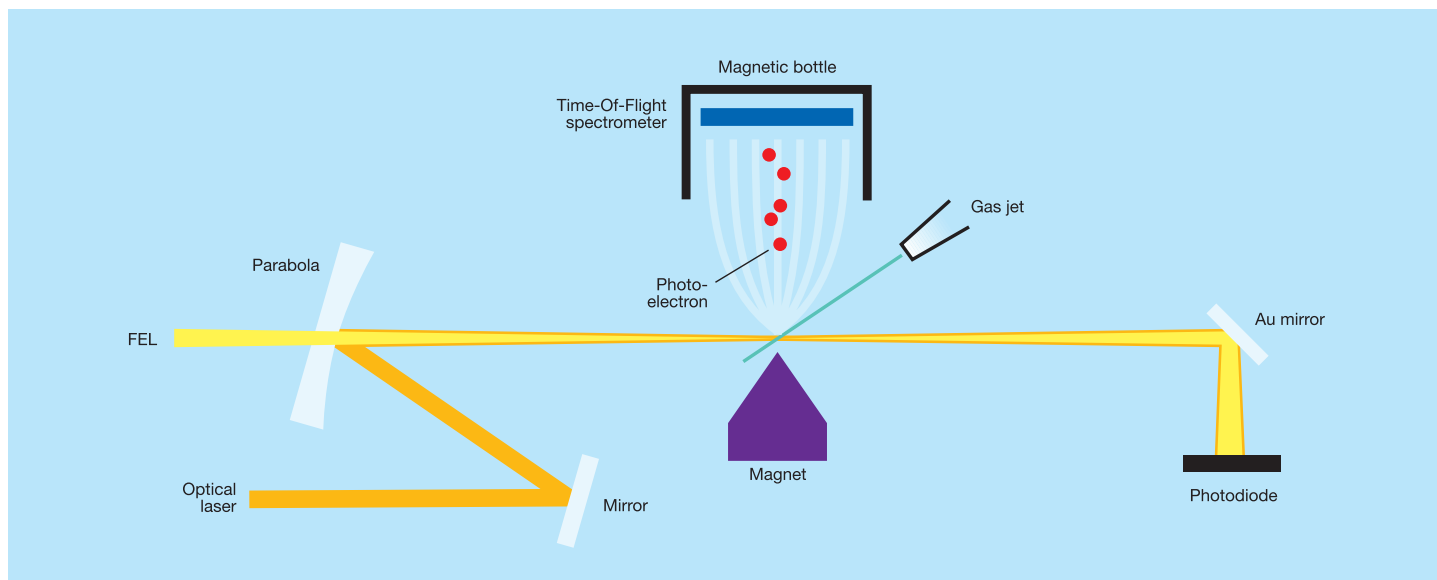

Experimental setup for the two-colour pump-and-probe experiments at FLASH using an optical laser and the free-electron laser

## Timing of femtosecond pump-and-probe pulses

*Pump-and-probe experiments using X-ray FELs may uncover the dynamics of ultrafast processes at the atomic level. The key to success is the ability to synchronize the femtosecond pump and probe pulses. An elegant experiment at FLASH proves it to be possible.*

Many physical, chemical and biochemical processes happen so fast that it is only possible to uncover the intermediate steps using femtosecond light sources. At the moment FLASH produces femtosecond pulses in the extreme-ultraviolet and soft X-ray regime. When the XFEL will start operating, it will deliver femtosecond pulses of hard X-rays and enable scientists to record the evolution of extremely fast processes at atomic resolution; provided the necessary experimental techniques have been developed.

The method of choice to study femtosecond dynamics are pump-and-probe experiments. At FLASH the FEL beam serves as pump source to start a reaction, while the optical laser pulses may be used to probe the state of the system at different time intervals after the reaction has been initiated. The key to success for future time-resolved pump-and-probe experiments at FLASH and XFEL is the ability to synchronize the two femtosecond pulses. Now a series of experiments at FLASH performed by researchers from LIXAM/CNRS and Université Pierre et Marie Curie in France, Dublin City University in Ireland, Queen's University Belfast in the United Kingdom, and DESY has proven this is indeed possible. In the fastest of these experiments optical pulses lasting 120 femtoseconds were crossed in space and time by 10- to 50-femtosecond FEL pulses. For this type of experiments, users can apply the laser pulses of the optical laser system available at the FLASH facility. (See also chapter "THE USER FACILITY" on page 22)

## Above-threshold ionization

A powerful tool to obtain information on the temporal overlap of two femtosecond pulses is given by the Above-Threshold Ionization (ATI) process. This technique utilizes electron spectroscopy of rare gas atoms to analyze the photoionization signal produced by FEL photons in the presence of the optical laser beam.

As the FEL pulse hits the rare gas, the energetic photons kick out electrons from the atoms. These electrons have a characteristic energy and give rise to the main line detected in the photoelectron spectrum. However, when the FEL pulse and the optical pulse overlap, the emitted photoelectrons are born into the strong optical field of the laser. Close to the atom these electrons can absorb or emit one or more photons from the optical laser field and thus change their energy by multiples of the photon energy of the optical laser.

This two-photon ionization process reveals itself as Side-Bands (SB) observed on both sides of the main atomic line in the photoelectron spectrum. These sidebands occur only when the two femtosecond pulses cross each other in space and time, and hence prove the overlap of the extremely fast pump and probe pulses. Since the effect depends strongly on the strength of the optical field, the intensity of the sidebands is a direct measure of the time interval between both laser pulses.

The experimental results from FLASH illustrate the successful combination of two very different laser types and clearly show the potential of short-wavelength FELs and optical laser pump-and-probe experiments. Apart from proving that synchronization is possible in the femtosecond regime, the experiments also open new and exciting opportunities for investigating fundamental photoionization and photodissociation processes. ➤

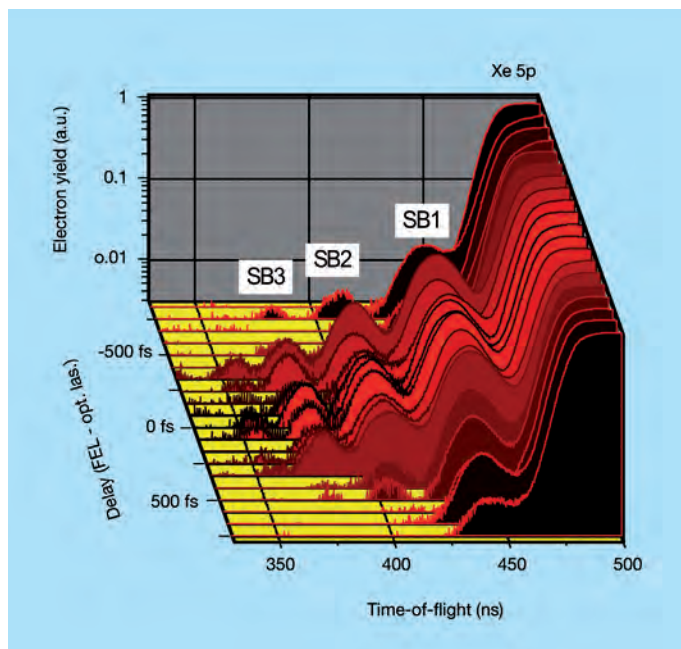

The figure shows part of the photoelectron spectrum for the two-photon ionization of xenon atoms by the 13.8-nanometer radiation from the FEL. Different spectra are given as a function of the time interval between the 120-femtosecond optical laser pulse and the FEL pulse of about 20 femtoseconds duration.

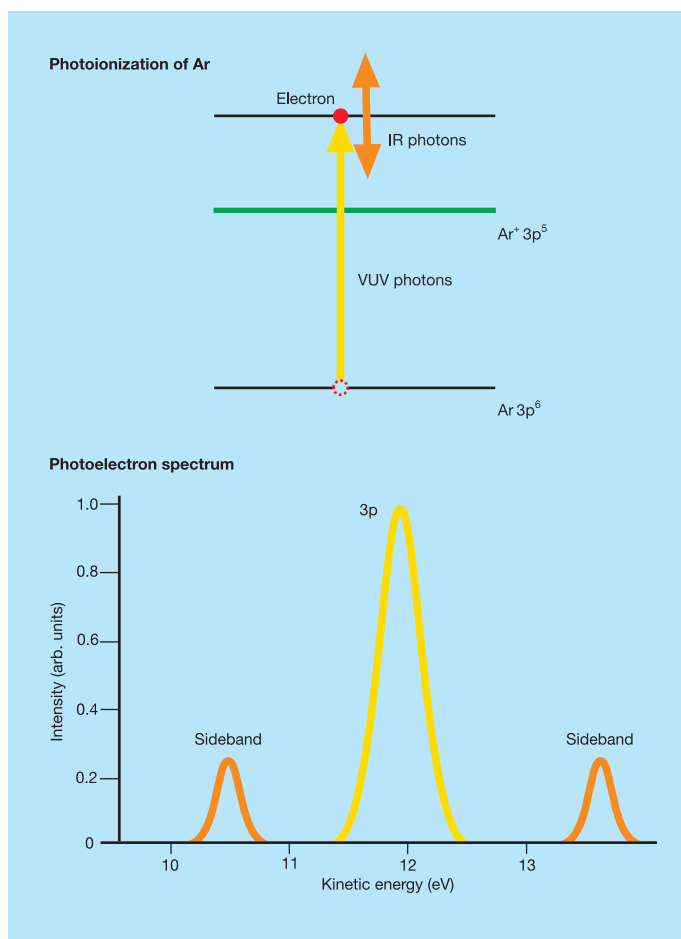

Schematic representation of the Above-Threshold Ionization (ATI) process giving rise to the sidebands in the photoelectron spectrum. Sidebands occur only at spatial and temporal overlap of the femtosecond optical and FEL pulses.



Researchers at work in the FLASH experimental hall

---

## Time resolution

At present the temporal resolution of the pump-and-probe experiments at FLASH depends on the length of the optical laser pulses, which is 120 femtoseconds at 800 nanometers in the infrared and 12 picoseconds for visible light at 523 nanometers. The width of the ATI cross-correlation signal is mainly determined by the temporal jitter of the FEL pulses with respect to the optical laser and represents the overall temporal resolution of around 250 femtoseconds (rms).

The temporal resolution will be considerably improved by using optical laser pulses of shorter duration and by eliminating the time jitter between FEL pulse and optical laser pulse, either with the help of single-shot techniques or by measuring the arrival times of the individual FEL pulses and correcting for the fluctuations.

A comparison of the measured intensities of single-shot sidebands and a theoretical analysis based on numerically solving the Time-Dependent Schrödinger Equation (TDSE) makes it possible to determine the relative temporal delay with an accuracy of better than 50 femtoseconds.



# Soft X-ray spectroscopy on trapped Fe<sup>23+</sup>

*Highly charged ions are abundant in the universe, but virtually no experimental data exists on their interactions with energetic photons. FLASH and future FELs may determine the electronic structure of highly charged ions with unprecedented precision providing critical input to stellar models and enabling high-accuracy tests of the theory of quantum electrodynamics.*

Highly charged ions stripped off most of their electrons, up to bare nuclei, constitute a dominant fraction of the visible matter in stars, supernovae, near-stellar clouds, and jets from active galactic nuclei; all abundant phenomena in the universe which astronomers have recently begun to explore with unprecedented accuracy in satellite missions like the XMM-Newton and the Chandra X-ray space telescope.

Precise knowledge of the electromagnetic line spectrum of highly charged ions is indispensable to understand these cosmic objects as well as the hot plasmas used in fusion energy research. However, up to date our insight into the interactions between highly charged ions and very energetic radiation, associated with e.g. supernovae and jets, is based almost entirely on theoretical model calculations. This is due to the fact that laser spectroscopy has been limited by the lack of appropriate light sources beyond the vacuum-ultraviolet spectral range. FLASH is the first in a series of upcoming FEL devices, like the LCLS in Stanford and the European XFEL in Hamburg, which will extend the accessible spectral range from a few eV to several keV. Thus, direct resonant laser spectroscopy experiments on highly charged ions, where one-electron bound-bound transitions up to 130 keV occur, will become feasible.

## Testing QED theory

Apart from their importance in astrophysics, the comparably simple electronic structure of highly charged ions makes them an ideal testing ground for the quantum theory of electromagnetic interactions, quantum electrodynamics (QED). This is the most precise theory in physics because no discrepancies between theory and experiment have been found up to now. QED is a quantum field theory of the electromagnetic force and is hence part of the standard model of particle physics. Experiments at FLASH and XFEL will allow for very stringent tests of theoretical QED predictions of the interactions between highly charged ions and very energetic radiation.

The few remaining electrons orbiting the atomic nucleus in such ions experience extreme electromagnetic fields, and field-dependent effects are strongly boosted by the powers of the nuclear charge ( $Z$ ) determining the field strength. The binding energy scales with  $Z^2$ , and the QED corrections of the binding energies, the Lamb shift, for example, already with  $Z^4$ .

Due to the steep scaling with  $Z$ , tunable soft and hard X-ray FELs can probe fundamental field-dependent effects such as electronic transitions in highly charged ions. Thus, by measuring transition energies in different highly charged ions all the way up to U<sup>89+</sup> QED theory can be tested and refined.

## Caught in the trap

Highly charged ions up to Fe<sup>23+</sup> have been produced in a new electron beam ion trap installed in the FLASH experimental hall. Successive electron impact ionization of the atoms by the electron beam of the trap strips off most of their electrons. The resulting highly charged positive ions are trapped by the negative space charge of the electron beam and by appropriate potentials of the trap electrodes. The trapped ions form a cylindrical cloud of 50 mm length and 200 - 300  $\mu\text{m}$  diameter with a density of about  $10^{10}$  ions/cm<sup>3</sup>.

In the experiments the ions in the trap were excited by intense femtosecond soft X-ray pulses from FLASH. The excited states live less than a nanosecond, and as the ions return to their ground state they emit fluorescence radiation, which is recorded by a detector. By using tunable, monochromatic FEL pulses the transition energies between the ground state and excited states in highly charged ions can be mapped out with unprecedented accuracy. ➤

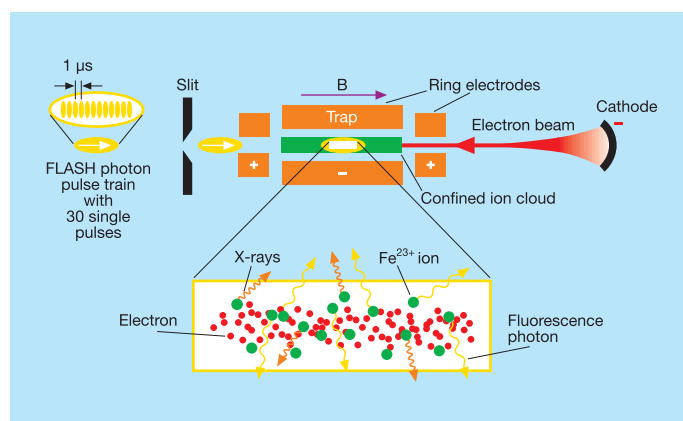

The experimental setup at FLASH: Lithium-like Fe<sup>23+</sup> ions were produced in a new electron beam ion trap depicted at the top of the figure. The highly charged ions were excited by femtosecond soft X-ray FEL pulses (yellow). Since the lifetime of the excited state is just 0.55 nanoseconds the relaxation results in immediate emission of fluorescence radiation, which was collected by X-ray mirrors and focused onto a microchannel plate detector.

## Lithium-like Fe<sup>23+</sup>

A group of scientists from the Max-Planck-Institute for Nuclear Physics in Heidelberg, the University of Hamburg and DESY has recently studied electronic transitions in Fe<sup>23+</sup>, a very abundant ion in e.g. solar flares.

Fe<sup>23+</sup> has only three electrons left and resembles lithium apart from the much stronger electromagnetic field experienced by the electrons. As a first objective the research group investigated the transition between the (1s<sup>2</sup>2s) <sup>2</sup>S<sub>1/2</sub> ground state and the excited (1s<sup>2</sup>2p) <sup>2</sup>P<sub>1/2</sub> state occurring in all three-electron ions from lithium to U<sup>89+</sup>. This electronic transition is closely related to the Lamb shift in atomic hydrogen which was the key for the discovery of QED. Thus, it is no surprise that the investigated transition plays a critical role in the formulation of few-electron QED theory in the strong electromagnetic fields of highly charged ions.

The experiment was performed in a single-photon resonant excitation scheme by tuning monochromatic FEL pulses through the resonance of this transition in Fe<sup>23+</sup> at an energy of 48.6 eV corresponding to a wavelength of 25.5 nm. The fluorescence photon yield emitted after relaxation of the excited state was registered as a function of the laser wavelength.

## Beyond theoretical uncertainty

According to QED theory various processes contribute to the total transition energy: inter-electronic interactions, single-electron one-loop terms comprising self-energy and vacuum polarization and the corresponding screening terms.

The relative accuracy achieved in the Fe<sup>23+</sup> experiment is already higher than the theoretical uncertainties, and the present experimental accuracy at FLASH allowed the researchers to verify the leading two-photon QED terms. Any further increase in the experimental precision will provide a systematic sensitivity improvement that may enable verification of the other processes contributing to the total transition energy.

In a few years photon energies up to 10 keV corresponding to a wavelength of 0.12 nm will become available with unprecedented flux at the LCLS and the European XFEL, and this will make it possible to investigate electronic transitions in all lithium-like ions including U<sup>89+</sup> using the experimental method developed at FLASH.

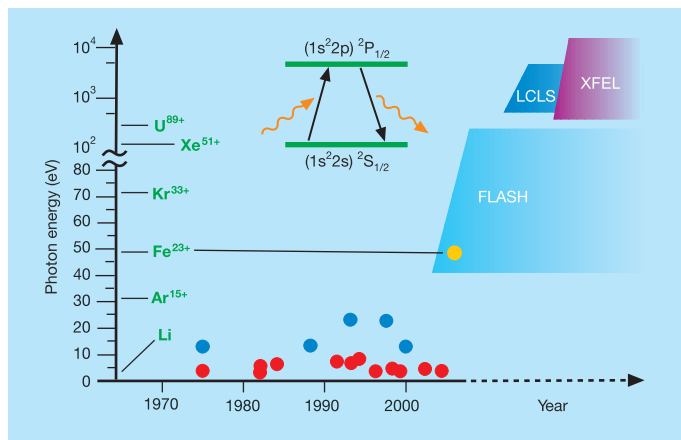

The photon energy range covered by FLASH and upcoming hard X-ray FELs will extend the accessible spectral range by several orders of magnitude (the scale is partly logarithmic). With the measurements of electronic transitions of Fe<sup>23+</sup> at FLASH this region has now been made accessible (yellow ball). The transition energy for the 1s<sup>2</sup>2s - 1s<sup>2</sup>2p excitation of some lithium-like systems (Kr<sup>33+</sup>, Xe<sup>51+</sup>, etc.) is shown in green. For comparison the figure displays some benchmarking VUV laser spectroscopy experiments on electronic transitions in neutral atoms (blue balls) as well as the most advanced laser spectroscopy experiments on transitions in highly charged ions (red balls).

# Multiphoton ionization – new opportunities at FLASH

Multiphoton processes cover areas as diverse as precision measurements, studies of ultrafast dynamics, laser acceleration of charged particles, laser machining of solid-state materials and medical applications. FLASH allows for the extension of these efforts from the infrared and visible part of the spectrum into the soft X-ray regime.

With the advent of lasers the nonlinear, or multiphoton, interactions between radiation and matter have become a key area in basic and applied research. In nonlinear processes the response of matter to intense radiation is no longer proportional to the intensity of the radiation but depends on a higher power of the intensity, giving rise to dramatic new effects which have been studied extensively using infrared or visible lasers.

Free-electron lasers like FLASH and the planned European facility XFEL will extend these studies towards the much shorter wavelengths of soft and hard X-rays, respectively. This new opportunity will greatly improve our knowledge of the fundamental interactions between radiation and matter, because a number of effects characterizing nonlinear processes at longer wavelengths vanish or diminish in the X-ray regime. Especially for atoms this considerably simplifies the situation and allows for stringent tests of the most advanced theoretical approaches. In addition, however, novel phenomena not present in the visible will emerge at X-ray energies like e.g. nonlinear Compton processes or simultaneous photon scattering (elastic and inelastic) and absorption.

## Infrared and visible lasers

The investigation of nonlinear interactions of intense laser radiation with atoms and molecules has already granted deep insights into the fundamental multiphoton processes. Exposing atoms to intense laser beams can result in multiple ionization, the generation of photoelectron sidebands in the Above-Threshold Ionization (ATI) process, the launch of rotational or vibrational wavepackets in ground, excited or ionized states of molecules, and in the emission of higher harmonics of the fundamental laser frequency at much shorter wavelengths (High Harmonic Generation, HHG) and attosecond pulse durations.

Since the ionization potential of atoms is greater than the photon energy in the infrared and visible parts of the spectrum, the atom has to absorb several photons to be ionized, and hence this process is called multiphoton ionization. However, at very high intensities the radiation field deforms the ionic potential so strongly that bound electrons can tunnel through the remaining potential barrier in a process called tunneling ionization. A third mechanism called rescattering also contributes to the ionization. In this process an emitted electron is accelerated and driven back to the atomic core by the laser field. In the encounter with the nucleus it can kick >

## The Keldysh parameter

The Keldysh parameter  $\gamma = \sqrt{IP/U_p}$  determines whether multiphoton or tunneling ionization dominates the nonlinear ionization processes, where the ponderomotive energy  $U_p$

$$U_p(\text{eV}) = 1.44 \frac{I(10^{13} \text{Wcm}^{-2})}{(h\nu(\text{eV}))^2}$$

denotes the mean energy transferred to an electron in its oscillatory motion caused by the electromagnetic laser field. For  $\gamma > 1$  multiphoton ionization dominates, whereas for  $\gamma < 0.5$  tunneling ionization takes over. Rescattering ionization contributes to the ionization for  $U_p$  larger than the atom's ionization potential  $IP$ .

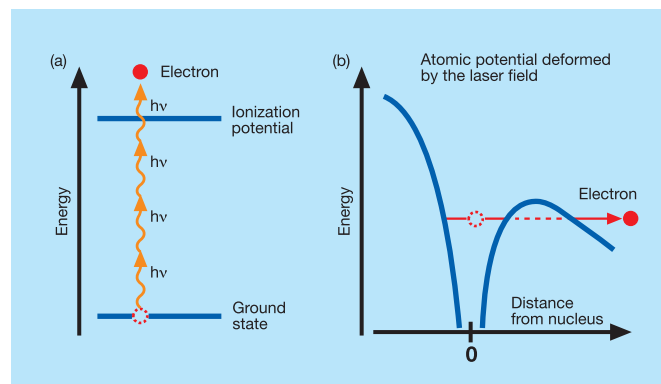

Multiphoton (a) and tunneling (b) ionization of atoms

Since the ponderomotive energy scales with the inverse square root  $(h\nu)^{-2}$  of the photon energy, the rescattering ionization, the above-threshold ionization and the higher harmonic generation all vanish at higher photon energies and not exceedingly large intensities. The contribution of tunneling ionization also decreases because the Keldysh parameter increases with increasing photon energy.

For example at an intensity of  $10^{16} \text{Wcm}^{-2}$ , achievable with FLASH at a photon energy of 92.5 eV corresponding to a wavelength of 13.4 nm, the ponderomotive energy amounts to 0.16 eV. A similar intensity at 1.55 eV photon energy, corresponding to a wavelength of 800 nm in the infrared, generates a ponderomotive energy of 600 eV. For the rare gas xenon with an ionization potential equal to 12.1 eV, the above-mentioned FLASH parameters result in a Keldysh parameter  $\gamma = 8.7$ .

## Doubly and triply charged argon ions

Perturbation theory predicts that the ionization yield  $Y$  should be proportional to the  $n^{\text{th}}$  power of the intensity  $Y \sim I^n$ , where  $n$  is the number of photons needed for ionization. In the double ionization of argon atoms non-sequential ionization and sequential ionization both require two photons. This is consistent with the exponent  $n = 2.0 \pm 0.1$  extracted from the data displayed in (a). The exponent of  $n = 3.5 \pm 0.2$  obtained by the analysis of the  $\text{Ar}^{3+}$  data given in (b) indicates that both non-sequential ionization and sequential ionization comparably contribute to the creation of  $\text{Ar}^{3+}$  ions.

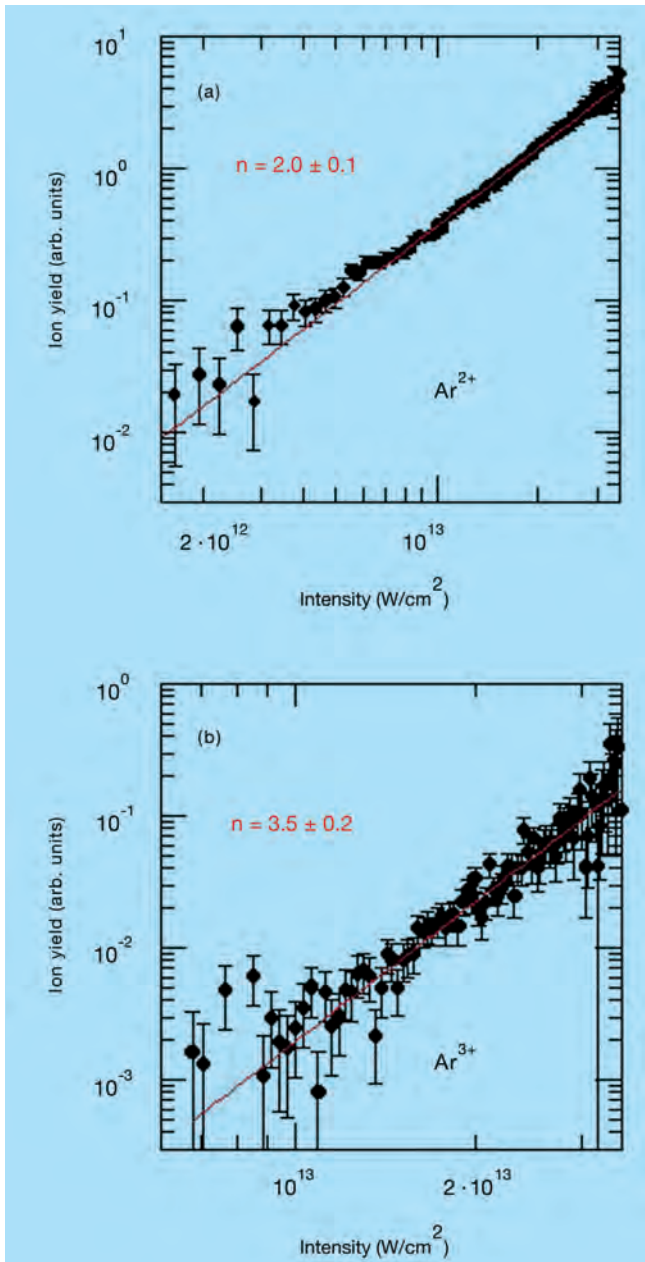

(a) The yield  $Y$  of doubly charged argon ions  $\text{Ar}^{2+}$ , and (b) triply charged argon ions  $\text{Ar}^{3+}$  is shown as a function of the intensity of the focused, approximately 30-femtosecond FLASH pulses at a photon energy of 38.8 eV.

out further electrons. Close to the atomic core, conserving energy and momentum, the electron can also absorb further laser photons (ATI) or emit higher harmonics of the fundamental laser frequency (HHG). At high intensities all these processes result in multiple ionization removing several electrons from the atom. A central parameter, called the Keldysh parameter, roughly determines which process dominates.

At FLASH, nonlinear interactions between light and matter can be studied at the higher photon energies in the vacuum-ultraviolet, extreme-ultraviolet and soft X-ray regimes. Here the rescattering ionization, the above-threshold ionization and the higher harmonics all vanish, and the contribution from tunneling ionization decreases. Thus, multiphoton ionization is expected to dominate the multiple ionization processes. This is why the nonlinear interactions, which can be explored using the intense FEL pulses, are much simpler than the processes hitherto studied using infrared and visible lasers.

### Few-photon multiple ionization at FLASH

The interaction of two or three photons with the valence electrons of an atom represents one of the most fundamental nonlinear processes, and detailed studies of these processes are of decisive importance to advance nonlinear theories.

At FLASH such nonlinear interactions have been studied by a group of scientists from MPI Heidelberg, University of Frankfurt, Stockholm University, University of Crete, and DESY as a function of the intensity in a series of experiments where argon atoms were multiply ionized with focused, approximately 30-femtosecond pulses at a photon energy of 38.8 eV corresponding to a wavelength of 32 nm. At the lower intensities studied the yield of doubly charged argon ions  $\text{Ar}^{2+}$  dominates, whereas the yield of triply charged argon ions  $\text{Ar}^{3+}$  increases with increasing intensity.

The first three ionization potentials of argon are 15.8 eV, 27.7 eV and 40.7 eV, respectively. Thus, a minimum energy of 43.5 eV is required to doubly ionize argon, and 84.2 eV are needed for the removal of three electrons. Two basic dynamical processes contribute to the multiple ionization. In sequential ionization the argon atom is ionized step by step “by one photon at a time”, while in non-sequential ionization several photons act simultaneously. Double ionization of argon by the non-sequential pathway requires the ejection of two electrons by simultaneous absorption of two photons, and simultaneous absorption of three photons is needed for triple ionization.

In the sequential process double ionization occurs in two steps. First the argon atom gets singly ionized by the absorption of one photon and then, in the second step, another electron is removed from the ion within the same FEL pulse. Here triple ionization requires the absorption of four photons. The first photon ionizes the atom to  $\text{Ar}^+$ . In the second step one additional photon ionizes the singly charged ion to  $\text{Ar}^{2+}$ , and in the third step two photons further ionize the doubly charged ion to  $\text{Ar}^{3+}$ . All these steps are induced by the same pulse.

According to theory, double ionization of argon requires two photons by both of the two ionization processes, which is consistent with the experimental results. The analysis of the  $\text{Ar}^{3+}$  data indicates that both non-sequential ionization and sequential ionization comparably contribute to the creation of the triply charged argon ions. Similar data on the multiple ionization of neon atoms corroborate the growing importance of sequential ionization with increasing intensity.

All these first experimental results show that FLASH already opens up new vistas in science and technology. ●

# FLASH AND ITS PERSPECTIVES.

Improvements for the users,  
self-seeding, faster beam switching and more

The main goal at FLASH in the next few years is to extend the possibilities for frontline research that may lead to scientific breakthroughs. Thus, several technological developments are being considered in order to improve the performance of the FEL.

FLASH is the only soft X-ray FEL user facility worldwide until 2009 when the Linear Coherent Light Source LCLS in Stanford will become available. Therefore all efforts are currently made to provide reliable and stable conditions for user experiments. To reach this goal and especially the design specifications for FLASH, extensive studies of the FEL process and improvements of the injector and the linear accelerator have to be performed in alternation with operation for users. Easy and precise tuning of the electron energy is another goal of great importance for the users. The development of diagnostic tools for electron and photon beams will continue to be of key importance for the success of the facility. A wiggler for the production of infrared (IR) radiation installed behind the undulators of FLASH will allow the determination of the longitudinal charge distribution of the electron bunches as well as novel pump-and-probe experiments combining IR with FEL radiation in the spectral range of the vacuum ultraviolet and extreme ultraviolet.

For the years to come most users are mainly interested in intense flashes of X-rays of 10 femtoseconds duration or even shorter, e.g. for pump-and-probe experiments. Here very good synchronization or accurate shot-by-shot measurements of the arrival time of the two pulses are needed.

Measurements of the time differences down to 100 fs have been done successfully at FLASH, these techniques will be further improved and developed to become routine tools. Research and development activities at DESY aim at reducing the jitter in the linac to the 10-femtosecond level. The most promising approach is based on the distribution of laser pulse streams in length-stabilized optical fiber links to all timing-critical locations including the linac cavities and the optical lasers used for pump-and-probe experiments. The laser pulse stream is generated by an erbium-doped fiber laser operating at a wavelength of 1550 nanometers where telecommunication components are inexpensive and readily available.

The timing and synchronization information is encoded in the precise repetition rate of the laser pulses. The system acts like an extremely precise master clock with an exact transmission of the timing signal to the various components affecting the jitter in a pump-and-probe experiment. A scheme for transporting short optical laser pulses over long distances with an accuracy of the order of few femtoseconds has already been demonstrated. In addition split and delay devices are under construction, which are of special importance for pump-and-probe experiments using the fundamental and higher harmonics in the FEL beam.

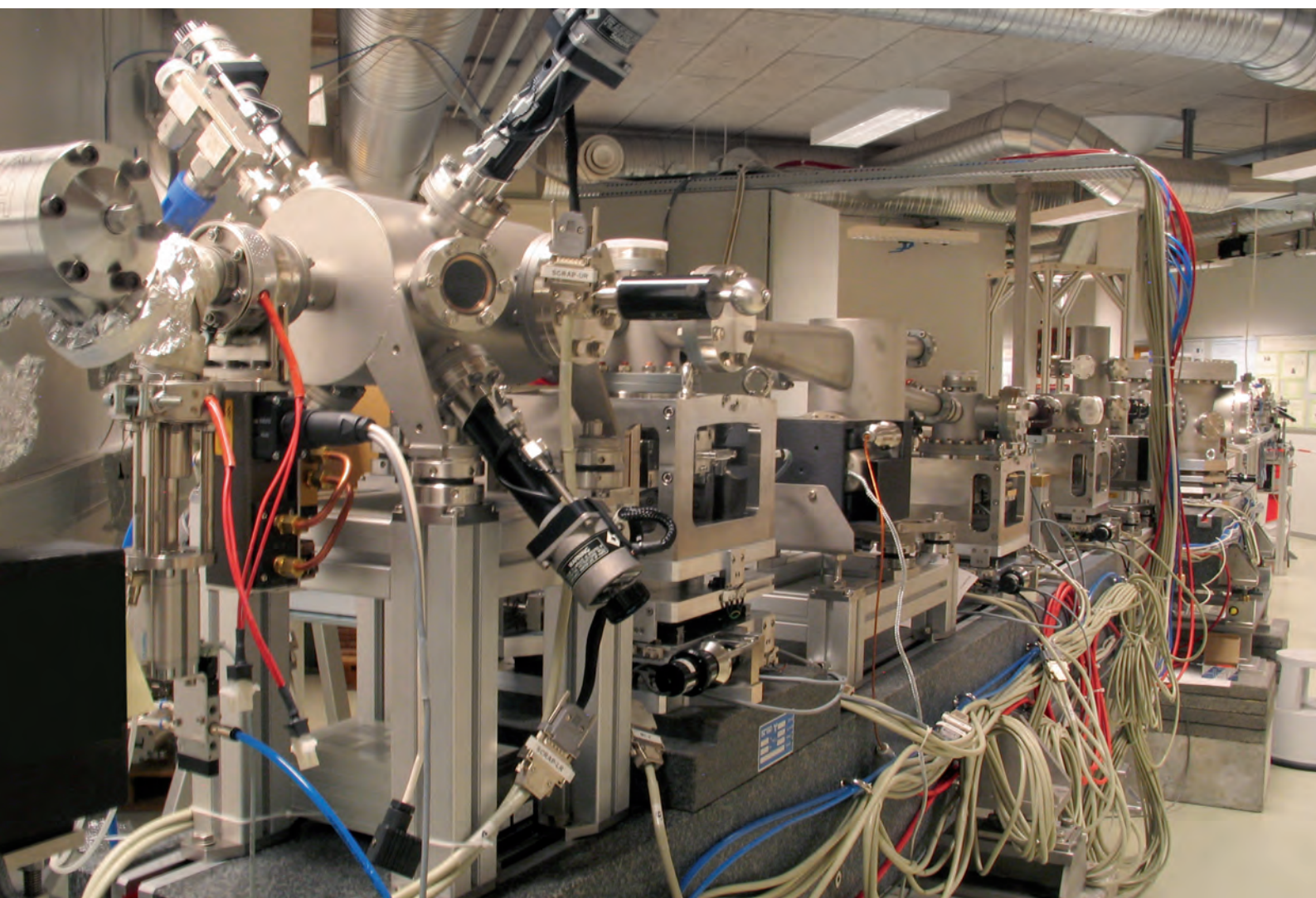

### Improved FEL radiation pulses by self-seeding

Strong efforts are made worldwide to apply seeding schemes in order to improve the quality of the FEL radiation pulses – for the pioneering work at FLASH, LCLS and the European XFEL the principle of Self-Amplified Spontaneous Emission (SASE) is used, where the FEL process starts from noise. At FLASH a self-seeding scheme will be implemented which is expected to provide a fully coherent beam with flashes of 200 fs duration and to increase the peak brilliance by two orders of magnitude. This mode of operation is very attractive for experiments that do not need the very short pulses, like high-energy density studies or high-resolution spectroscopy, such as Raman spectroscopy on correlated electron systems or samples of biological interest. There is also discussion of the possibilities to create femtosecond or even sub-femtosecond pulses in the wavelength range around 30 nm at FLASH by seeding with an intense external laser pulse produced by High Harmonic Generation (HHG). By splitting the optical seed pulse excellent synchronization will be possible and exciting investigations of many-body dynamics in strong laser fields, as an example, could be performed. The unique selling point of FLASH is in the combination of the extreme peak brilliance typical for all X-ray FELs with a very high average

brilliance, which will be between three and four orders of magnitude higher than the best storage ring synchrotron radiation facilities once FLASH reaches its specifications. FLASH is thus especially attractive for experiments with highly diluted targets like spectroscopy of highly charged ions needing high average brilliance to reach the necessary statistical accuracy, especially if a reaction microscope is used as a detector which fully determines the scattering kinematics, or for imaging of single particles flying through the FEL beam, where high luminosity is the key criterion for success. In general, an increasing effort will be needed to prepare specific samples for FEL experiments as well as to develop novel detectors for best use of the FEL radiation.

### Further new possibilities for the experiments

There is a strong scientific case for FELs producing X-rays and therefore an equally strong interest in reaching this spectral range as soon as possible. At FLASH the linear accelerator will be extended to its full energy of 1 GeV in the summer of 2007, and lasing at wavelengths close to 6 nm or photon energies near 200 eV is expected for fall 2007. Taking into account that the 3rd and 5th harmonic are only two and four orders of magnitude weaker than the >

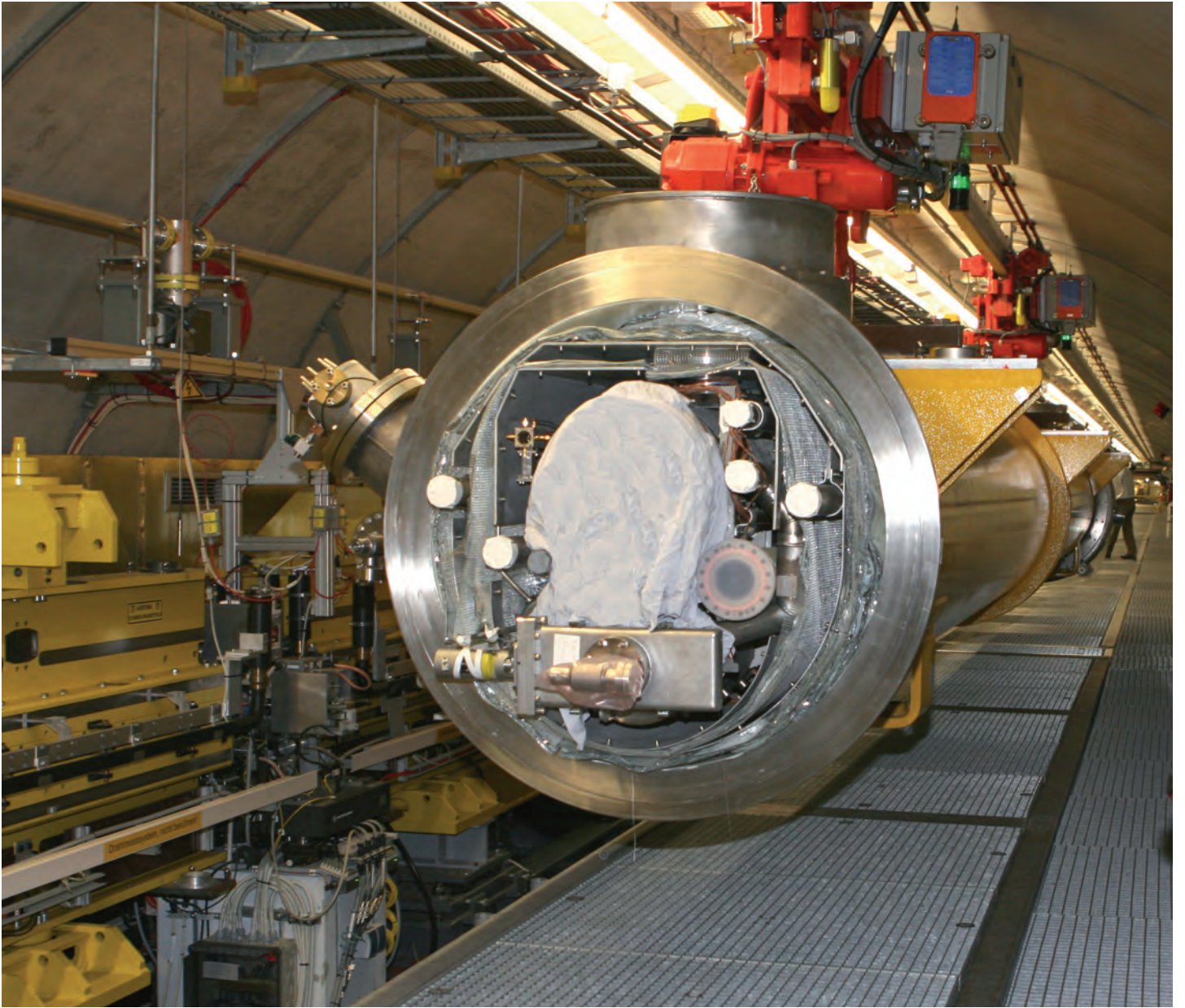

On the way to the design electron energy of 1 GeV: replacement of accelerator modules in the FLASH tunnel during the summer shutdown 2007



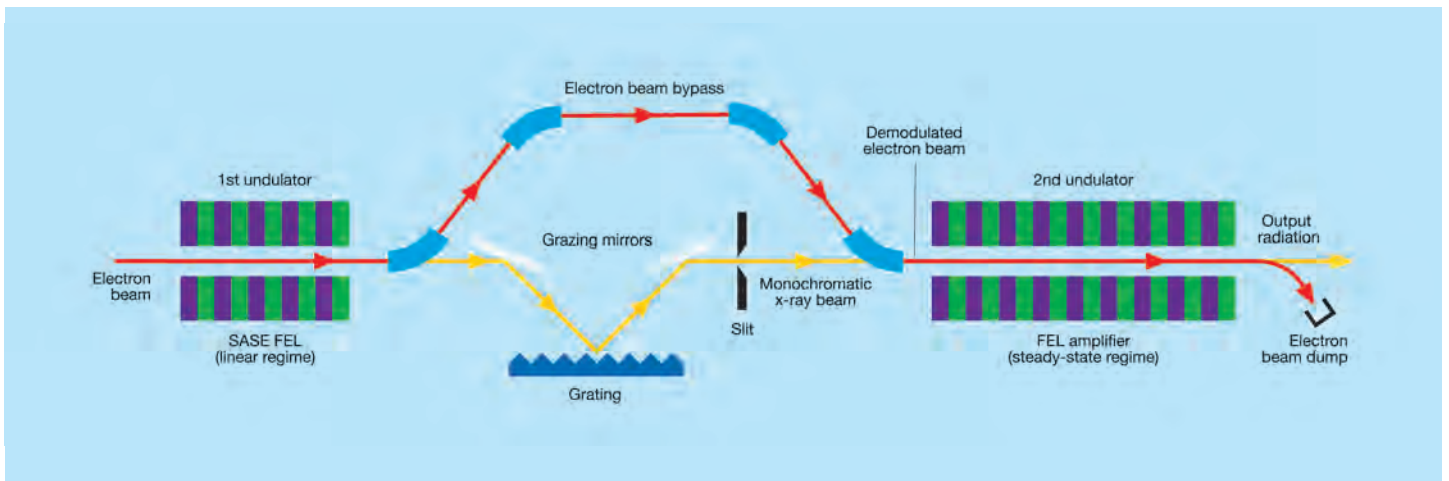

The self-seeding mechanism: The SASE process is started in the first undulator but not driven into saturation. Subsequently the electron beam is deviated over a bypass where the microbunching is removed, and led to the entrance of the final undulator. The soft X-ray beam produced in the first undulator is transported through a high-resolution monochromator selecting a fully coherent narrow-band but stretched radiation pulse that meets the electron pulse at the entrance of the second undulator and seeds it, i.e. initiates the microbunching process in a controlled way. This way the coherent, narrow-band radiation is amplified to saturation, increasing the peak brilliance by approximately two orders of magnitude at the expense of the pulse duration which is then about 200 femtoseconds.

fundamental, the “water window” is easily reached and time-resolved spectroscopy experiments can be performed at photon energies up to 600 eV. This enables e.g. most interesting applications in magnetization dynamics with a time resolution of 10 femtoseconds. A 20-percent increase of linac energy is among the options for further upgrades of FLASH currently under discussion.

One of the key issues at FLASH (and other FELs in the future) is to maximize the usage of the single radiation beam that it produces. Currently the FEL beam is switched to different experiments on a shift-by-shift basis in order to change the wavelength, if required, and to give one user team the chance to change samples or evaluate data while the other team uses the beam for experiments. It is intended to further increase the efficiency by faster switching of the beam, up to once a second, so that two experiments can be done quasi simultaneously; for example, one experiment makes use of single pulses for coherent imaging while the other uses a bunch

train to accumulate electron and ion distributions of single atoms, molecules or ions. In the future the total user capacity of the facility could practically be doubled by building a second undulator with variable gap, including additional beamlines and experimental stations. This would allow fully parallel operation of two experiments at different wavelengths and pulse rates etc. Such possibilities are currently being investigated.

FLASH has been at the forefront of FEL development and science applications, it is supported by a strong German and international user community, and with some upgrades it will offer unique features in a spectral range that includes the water window and the L edges of the 3d transition elements and is complementary to the LCLS and other European FEL projects. Therefore, FLASH is extremely well positioned for many years, at least until the middle of the next decade. ●

# FURTHER READING.

Status: April 2007

In this section, a selection of publications is listed, ordered according to three different topics and the date of publication, respectively. On the enclosed CD you will find more information on these topics, e.g. articles from conference proceedings and annual reports, and the brochure itself including all images prepared for download. For recent results, papers which have been accepted just before the editorial deadline of this brochure complete the list. Full-text versions are included as far as the publishers gave their permission.

## The FLASH installation

*Published in Nuclear Instruments and Methods in Physics Research A, 445, 366 (1 May 2000)*

### **Undulators for SASE FELs**

J. Pflüger

*The author of this publication comes from the following affiliation: Deutsches Elektronen-Synchrotron DESY, Hamburg, Germany*

*Published in Physical Review Letters, Vol. 85, No. 18, 3825 (30 October 2000)*

### **First observation of self-amplified spontaneous emission in a free-electron laser at 109 nm wavelength**

J. Andruszkow, B. Aune, V. Ayvazyan, N. Baboi, R. Bakker, et al.

*The 145 authors of this publication come from the following affiliations: Advanced Photon Source, Argonne National Laboratory, IL, USA; BESSY, Berlin, Germany; Branch of the Institute of Nuclear Physics, Protvino, Russia; CEA Saclay, Gif-sur-Yvette, France; Darmstadt University of Technology, FB18-Fachgebiet TEMF, Germany; Deutsches Elektronen-Synchrotron DESY, Hamburg, Zeuthen, Germany; Faculty of Physics and Nuclear Techniques, University of Mining and Metallurgy, Cracow, Poland; Fermi National Accelerator Laboratory, Batavia, IL, USA; Universität Hamburg, Institut für Experimentalphysik, Germany; Institute of High Energy Physics IHEP, FEL Laboratory, Beijing, People's Republic of China; Institute of High Energy Physics, Protvino, Russia; INFN-LNF, Frascati, Italy; INFN Milano-LASA, Segrate (MI), Italy; INFN-Roma2, Roma, Italy; Institute of Nuclear Physics, Krakow, Poland; Institute for Nuclear Research of RAS, Moscow, Russia; Institute of Physics, Polish Academy of Sciences, Warsaw, Poland; Institut de Physique Nucléaire (CNRS-IN2P3), Orsay, France; Joint Institute for Nuclear Research, Dubna, Russia; Laboratoire de l'Accélérateur Linéaire, IN2P3-CNRS, Université de Paris-Sud, Orsay, France; Max-Born-Institute, Berlin, Germany; Newman Lab, Cornell University, Ithaca, NY, USA; RWTH Aachen-Physikzentrum, Physikalisches Institut IIIa, Germany; UCLA Department of Physics and Astronomy, Los Angeles, CA, USA; University of Rochester, Department of Physics and Astronomy, Rochester, NY, USA; Yerevan Physics Institute, Yerevan, Armenia*

*Published in Physical Review Letters, Vol. 88, No. 10, 104802 (11 March 2002)*

### **Generation of GW radiation pulses from a VUV free-electron laser operating in the femtosecond regime**

V. Ayvazyan, N. Baboi, I. Bohnet, R. Brinkmann, M. Castellano, et al.

*The 84 authors of this publication come from the following affiliations: CEA Saclay, Gif-sur-Yvette, France; Darmstadt University of Technology, FB18-Fachgebiet TEMF, Germany; Darmstadt University of Technology, Institut für Kernphysik, Germany; Deutsches Elektronen-Synchrotron DESY, Hamburg, Zeuthen, Germany; Fermi National Accelerator Laboratory, Batavia, IL, USA; Universität Hamburg, Institut für Experimentalphysik, Germany; INFN-LNF, via Frascati, Italy; INFN Milano-LASA, Milano, Italy; INFN-Roma2, Roma, Italy; Institute for Nuclear Research of RAS, Moscow, Russia; Institute of Physics, Polish Academy of Sciences, Warsaw, Poland; Joint Institute for Nuclear Research, Dubna, Russia; Laboratoire de l'Accélérateur Linéaire, IN2P3-CNRS, Université de Paris-Sud, Orsay, France; Max Born Institute, Berlin, Germany; NILPRP, Bucharest, Romania; RWTH Aachen-Physikzentrum, Physikalisches Institut IIIa, Germany; Warsaw University of Technology, Institute of Physics, Poland; Yerevan Physics Institute, Yerevan, Armenia*

*Published in The European Physical Journal D, Vol. 20, 146 (28 June 2002)*

### **A new powerful source for coherent VUV radiation: Demonstration of exponential growth and saturation at the TTF free-electron laser**

V. Ayvazyan, N. Baboi, I. Bohnet, R. Brinkmann, M. Castellano, et al.

*The 85 authors of this publication come from the following affiliations: CEA Saclay, Gif-sur-Yvette, France; Darmstadt University of Technology, F.B. 18, Fachgebiet TEMF, Germany; Darmstadt University of Technology, Institut für Kernphysik, Germany; Deutsches Elektronen-Synchrotron DESY, Hamburg, Zeuthen, Germany; Fermi National Accelerator Laboratory, Batavia, IL, USA; Universität Hamburg, Institut für Experimentalphysik, Germany; INFN-LNF, Frascati, Italy; INFN Milano-LASA, Segrate (MI), Italy; INFN-Roma2, Roma, Italy; Institute for Nuclear Research of RAS, Moscow, Russia; Institute of Physics, Polish Academy*

of Sciences, Warsaw, Poland; Joint Institute for Nuclear Research, Dubna, Russia; Laboratoire de l'Accélérateur Linéaire, IN2P3-CNRS, Université de Paris-Sud, Orsay, France; Max-Born-Institute, Berlin, Germany; Rhein-Ahr-Campus Remagen, Germany; RWTH Aachen-Physikzentrum, Phys. Inst. IIIa, Germany; Warsaw University of Technology, Institute of Physics, Poland; Yerevan Physics Institute, Yerevan, Armenia

*Published in Nuclear Instruments and Methods in Physics Research A, Vol. 507, 368 (11 July 2003)*

**Study of the statistical properties of the radiation from a VUV SASE FEL operating in the femtosecond regime**

V. Ayvazyan, J.-P. Carneiro, P. Castro, B. Faatz, A.A. Fateev, et al.

*The 36 authors of this publication come from the following affiliations: Deutsches Elektronen-Synchrotron DESY, Hamburg, Germany; Joint Institute for Nuclear Research, Dubna, Russia; Institute for Nuclear Research of RAS, Moscow, Russia; Yerevan Physics Institute, Yerevan, Armenia; RWTH Aachen-Physikzentrum, Phys. Inst. IIIa, Germany*

*Published in Nuclear Instruments and Methods in Physics Research A, Vol. 507, 335 (11 July 2003)*

**Bunch length and phase stability measurements at the TESLA test facility**

Ch. Gerth, J. Feldhaus, K. Honkavaara, K.D. Kavanagh, Ph. Piot, et al.

*The 8 authors of this publication come from the following affiliations: Deutsches Elektronen-Synchrotron DESY, Hamburg, Germany; School of Physical Sciences, Dublin City University, Ireland; Max-Born-Institut, Berlin, Germany*

*Published in Nuclear Instruments and Methods in Physics Research A, Vol. 507, 175 (11 July 2003)*

**Study of the transverse coherence at the TTF free-electron laser**

R. Ischebeck, J. Feldhaus, C. Gerth, E. Saldin, P. Schmüser, et al.

*The 11 authors of this publication come from the following affiliations: Deutsches Elektronen-Synchrotron DESY, Hamburg, Germany; Universität Hamburg, Institut für Experimentalphysik, Germany; Rheinisch-Westfälische Technische Hochschule Aachen, III. Physikalisches Institut, Germany; Joint Institute for Nuclear Research, Dubna, Russia*

*Published in Nuclear Instruments and Methods in Physics Research A, Vol. 524, 1 (21 May 2004)*

**Achievement of 35 MV/m in the superconducting nine-cell cavities for TESLA**

L. Lilje, E. Kako, D. Kostin, A. Matheisen, W.-D. Möller, et al.

*The 12 authors of this publication come from the following affiliations: Deutsches Elektronen-Synchrotron DESY, Hamburg, Germany; KEK, High Energy Accelerator Research Organization, Tsukuba, Ibaraki, Japan; Universität Hamburg, Germany; Nomura Plating Co., Kanuma, Tochigi, Japan*

*Published in The European Physical Journal D, Vol. 37, 297 (2006)*

**First operation of a free-electron laser generating GW power radiation at 32 nm wavelength**

V. Ayvazyan, N. Baboi, J. Bähr, V. Balandin, B. Beutner, et al.

*The 36 authors of this publication come from the following affiliations: CEA Saclay, Gif-sur-Yvette, France; Bayerische Julius-Maximilians Universität, Institut für Theor. Physik u. Astrophysik, Würzburg, Germany; BESSY GmbH, Berlin, Germany; Center for the Advancement of Natural*

*Discoveries using Light Emission CANDLE, Yerevan, Armenia; Technische Universität Darmstadt, FB 18, Institut TEMF, Germany; Deutsches Elektronen-Synchrotron DESY, Hamburg, Zeuthen, Germany; Fermi National Accelerator Laboratory, Batavia, IL, USA; Universität Hamburg, Institut für Experimentalphysik, Germany; INFN, Dept. of Information Engineering, University of Padova, Italy; INFN-LNF, Frascati, Italy; INFN Milano-LASA, Segrate (MI), Italy; INFN-Roma2, Roma, Italy; Institute for Nuclear Researches and Nuclear Energy, Sofia, Bulgaria; Joint Institute for Nuclear Research, Dubna, Russia; Laboratoire de l'Accélérateur Linéaire, IN2P3-CNRS, Université de Paris-Sud, Orsay, France; Max-Born-Institute, Berlin, Germany; Stanford Linear Accelerator Center, Menlo Park, CA, USA*

## The FLASH user facility

*Published in Applied Physics Letters, Vol. 83, No. 14, 2970 (6 October 2003)*

**Measurement of gigawatt radiation pulses from a vacuum- and extreme-ultraviolet free-electron laser**

M. Richter, A. Gottwald, U. Kroth, A.A. Sorokin, S.V. Bobashev, et al.

*The 11 authors of this publication come from the following affiliations: Physikalisch-Technische Bundesanstalt, Berlin, Germany; Ioffe Physico-Technical Institute, St. Petersburg, Russia; Deutsches Elektronen-Synchrotron DESY, Hamburg, Germany*

*Published in Applied Physics Letters, Vol. 84, No. 5, 657 (2 February 2004)*

**Total-reflection amorphous carbon mirrors for vacuum-ultraviolet free-electron lasers**

B. Steeg, L. Juha, J. Feldhaus, S. Jacobi, R. Sobierajski, et al.

*The 8 authors of this publication come from the following affiliations: Deutsches Elektronen-Synchrotron DESY, Hamburg, Germany; GKSS Research Center, Geesthacht, Germany; Warsaw University of Technology, Poland; Incoatec GmbH, Geesthacht, Germany; Institute of Experimental Physics, University of Bialystok, Poland; Institute of Physics PAS, Warsaw, Poland*

*Published in Journal of Electron Spectroscopy and Related Phenomena Vol. 144–147, 1055 (16 February 2005)*

**Grazing incidence spectrometer for the monitoring of the VUV-FEL beam at DESY**

P. Nicolosi, L. Poletto, M.G. Pelizzo, L. Epulandi, P. Zambolin, J. Feldhaus, et al.

*The 10 authors of this publication come from the following affiliations: INFN-LUXOR, Department of Information Engineering, University of Padova, Italy; Deutsches Elektronen-Synchrotron DESY, Hamburg, Germany*

*Published in Review of Scientific Instruments, Vol. 77, 115108 (29 November 2006)*

**Monochromator beamline for FLASH**

M. Martins, M. Wellhöfer, J.T. Hoeft, W. Wurth, J. Feldhaus, R. Follart

*The 6 authors of this publication come from the following affiliations: Institut für Experimentalphysik, Universität Hamburg, Germany; Deutsches Elektronen-Synchrotron DESY, Hamburg, Germany; Berliner Elektronenspeicherring – Gesellschaft für Synchrotronstrahlung mbH BESSY, Berlin, Germany >*

*Published in Applied Physics Letters, Vol. 90, 121112 (21 March 2007)*

**Time-to-space mapping in a gas medium for the temporal characterization of vacuum-ultraviolet pulses**

S. Cunovic, N. Müller, R. Kalms, M. Krikunova, M. Wieland, M. Drescher, et al.

*The 11 authors of this publication come from the following affiliations:*

Department of Physics, Bielefeld University, Germany; Institut für Experimentalphysik, Universität Hamburg, Germany; Deutsches Elektronen-Synchrotron DESY, Hamburg, Germany

*Published in Applied Physics Letters, Vol. 90, 173128 (27 April 2007)*

**Damage threshold of inorganic solids under free-electron laser irradiation at 32.5 nm wavelength**

S.P. Hau-Riege, R.A. London, R.M. Bionta, M.A. McKernan, S.L. Baker, et al.

*The 26 authors of this publication come from the following affiliations:*

Lawrence Livermore National Laboratory LLNL, Livermore, CA, USA; Institute of Physics PAS, Warsaw, Poland; Institute of Physics ASCR, Prague, Czech Republic; Czech Technical University, Kladno, Czech Republic; Deutsches Elektronen-Synchrotron DESY, Hamburg, Germany; Department of Cell and Molecular Biology, Biomedical Centre, Uppsala University, Sweden; Institut für Experimentelle Physik, Universität Duisburg-Essen, Germany; Institut für Optik und Quantenelektronik der Universität Jena, Germany

## Research results at FLASH

*Published in Optics Letters, Vol. 31, No. 11 (1 June 2006)*

**Spectroscopic characterization of vacuum-ultraviolet free-electron laser pulses**

S. Düsterer, P. Radcliffe, G. Geloni, U. Jastrow, M. Kuhlmann, et al.

*The 17 authors of this publication come from the following affiliations:*

Deutsches Elektronen-Synchrotron DESY, Hamburg, Germany; INFN-LUXOR, Department of Information Engineering, University of Padova, Italy; National Center for Plasma Science and Technology and School of Physical Sciences, Dublin City University, Ireland; International Research Centre for Experimental Physics, Queen's University Belfast, United Kingdom; LIXAM/CNRS, Centre Universitaire Paris-Sud, Orsay, France

*Published in Journal of Physics B, Vol. 39, L299 (30 June 2006)*

**Multiphoton ionization of molecular nitrogen by femtosecond soft X-ray FEL pulses**

A.A. Sorokin, S.V. Bobashev, K. Tiedtke, M. Richter

*The 4 authors of this publication come from the following affiliations:*

Physikalisch-Technische Bundesanstalt, Berlin, Germany; Ioffe Physico-Technical Institute, St. Petersburg, Russia; Deutsches Elektronen-Synchrotron DESY, Hamburg, Germany

*Published in Physical Review A,*

*Vol. 74 – Rapid Communications, 011401(R) (14 July 2006)*

**Two-color photoionization in XUV free-electron and visible laser fields**

M. Meyer, D. Cubaynes, P.O. Keefe, H. Luna, P. Yeates, et al.

*The 16 authors of this publication come from the following affiliations:*

LIXAM/CNRS, Centre Universitaire Paris-Sud, Orsay, France; National Center for Plasma Science and Technology and School of Physical Sciences, Dublin City University, Ireland; International Research Centre for Experimental Physics (IRCEP), Queen's University Belfast, United Kingdom; Laboratoire de Chimie Physique-Matière et Rayonnement, Université Pierre et Marie Curie, Paris, France; Deutsches Elektronen-Synchrotron DESY, Hamburg, Germany

*Published in Applied Physics Letters,*

*Vol. 89, 221114 (29 November 2006)*

**Method based on atomic photoionization for spot-size measurement on focused soft X-ray free-electron laser beams**

A.A. Sorokin, A. Gottwald, A. Hoehl, U. Kroth, H. Schöppe, et al.

*The 19 authors of this publication come from the following affiliations:*

Physikalisch-Technische Bundesanstalt, Berlin, Germany; Ioffe Physico-Technical Institute, St. Petersburg, Russia; Deutsches Elektronen-Synchrotron DESY, Hamburg, Germany

*Published in nature physics, Vol. 2, 839 (12 December 2006)*

**Femtosecond diffractive imaging with a soft X-ray free-electron laser**

H.N. Chapman, A. Barty, M.J. Bogan, S. Boutet, M. Frank, et al.

*The 34 authors of this publication come from the following affiliations:*

University of California, Lawrence Livermore National Laboratory, Livermore, California, USA; Center for Biophotonics Science and Technology, University of California, Davis, Sacramento, California, USA; Stanford Synchrotron Radiation Laboratory, Stanford Linear Accelerator Center, Menlo Park, California, USA; Laboratory of Molecular Biophysics, Department of Cell and Molecular Biology, Uppsala University, Sweden; Deutsches Elektronen-Synchrotron DESY, Hamburg, Germany; Spiller X-ray Optics, Livermore, California, USA; Institut für Optik und Atomare Physik, Technische Universität Berlin, Germany

*Published in Applied Physics Letters,*

*Vol. 89, 241909 (12 December 2006)*

**Ablation of solids using a femtosecond extreme-ultraviolet free-electron laser**

N. Stojanovic, D. von der Linde, K. Sokolowski-Tinten, U. Zastra, et al.

*The 23 authors of this publication come from the following affiliations:*

Institut für Experimentelle Physik, Universität Duisburg-Essen, Germany; Institut für Optik und Quantenelektronik, FSU Jena, Germany; Institute of Physics PAS, Warsaw, Poland; Institute of Physics ASCR, Prague, Czech Republic; Czech Technical University, Prague, Czech Republic; Deutsches Elektronen-Synchrotron DESY, Hamburg, Germany

*Published in Applied Physics Letters, Vol. 90, 131108 (28 March 2007)*

**Single-shot characterization of independent femtosecond extreme-ultraviolet free-electron and infrared laser pulses**

P. Radcliffe, S. Düsterer, A. Azima, H. Redlin, J. Feldhaus, et al.

*The 18 authors of this publication come from the following affiliations:*

Deutsches Elektronen-Synchrotron DESY, Hamburg, Germany; National Center for Plasma Science and Technology and School of Physical Sciences, Dublin City University, Ireland; International Research Centre for Experimental Physics, Queen's University Belfast, Ireland, United Kingdom; Laboratoire de Chimie Physique-Matière et Rayonnement, Université Pierre et Marie Curie, Paris, France; LIXAM/CNRS, Centre Universitaire Paris-Sud, Orsay, France

*Published in Physical Review Letters, Vol. 98, 145502 (4 April 2007)*

**Sub-nanometer-scale measurements of the interaction of ultrafast soft X-ray free-electron laser pulses with matter**

S.P. Hau-Riege, H.N. Chapman, J. Krzywinski, R. Sobierajski, S. Bajt, et al.

*The 21 authors of this publication come from the following affiliations:*

Lawrence Livermore National Laboratory, Livermore, CA, USA; Institute of Physics PAS, Warsaw, Poland; Department of Cell and Molecular Biology, Biomedical Centre, Uppsala University, Sweden; Institute of Physics

ASCR, Prague, Czech Republic; Czech Technical University, Prague, Czech Republic; Institut für Experimentelle Physik, Universität Duisburg-Essen, Germany; Universities Space Research Association, Brookhaven National Laboratory, Upton, NY, USA; Lawrence Berkeley National Laboratory, Berkeley, CA, USA; Deutsches Elektronen-Synchrotron DESY, Hamburg, Germany

*Published in Physical Review Letters, Vol. 98, 183001 (1 May 2007)*

**Soft X-ray laser spectroscopy on trapped highly charged ions at FLASH**

S.W. Epp, J. R. Crespo López-Urrutia, G. Brenner, V. Mäckel, et al.

*The 13 authors of this publication come from the following affiliations:*

Max-Planck-Institut für Kernphysik, Heidelberg, Germany; Deutsches Elektronen-Synchrotron DESY, Hamburg, Germany; Institut für Experimentalphysik, Universität Hamburg, Germany

*Published in Optical Express, Vol. 15, No.10, 6036 (2 May 2007)*

**Characteristics of focused soft X-ray free-electron laser beam determined by ablation of organic molecular solids**

J. Chalupský, L. Juha, J. Kuba, J. Cihelka, V. Hájková, et al.

*The 29 authors of this publication come from the following affiliations:*

Institute of Physics, Academy of Sciences of the Czech Republic, Prague, Czech Republic; Czech Technical University in Prague, Czech Republic; J. Heyrovský Institute of Physical Chemistry, Academy of Sciences of the Czech Republic, Prague, Czech Republic; Charles University in Prague, Czech Republic; Biomedical Centre, Uppsala University, Sweden; Lawrence Livermore National Laboratory, Livermore, CA, USA; Institute of Physics, Polish Academy of Sciences, Warsaw, Poland; Soltan Institute for Nuclear Studies, Swierk, Poland; Max-Planck-Institut für Quantenoptik, Garching, Germany; University of Duisburg-Essen, Germany; Deutsches Elektronen-Synchrotron DESY, Hamburg, Germany; University of Jena, Germany

*Published in Physical Review A,*

*Vol. 75 – Rapid Communications, 051402(R) (3 May 2007)*

**X-ray-laser interaction with matter and the role of multiphoton ionization: free-electron laser studies on neon and helium**

A.A. Sorokin, M. Wellhöfer, S.V. Bobashev, K. Tiedtke, M. Richter

*The 5 authors of this publication come from the following affiliations:*

Physikalisch-Technische Bundesanstalt, Berlin, Germany; Ioffe Physico-Technical Institute, St. Petersburg, Russia; Institut für Experimentalphysik, Universität Hamburg, Germany; Deutsches Elektronen-Synchrotron DESY, Hamburg, Germany ●

## Imprint

### *Publisher*

Deutsches Elektronen-Synchrotron DESY,  
Member of the Helmholtz Association  
Notkestrasse 85, 22607 Hamburg, Germany

Tel.: (+ 49 40) 89 98 - 0, Fax: (+ 49 40) 89 98 - 32 82  
desyinfo@desy.de, www.desy.de

*We would like to thank everyone who contributed  
to the making of this brochure.*

### *Authors*

Jochen R. Schneider  
Rolf Haugaard Nielsen, Science journalist, Valby, Denmark;  
Josef Feldhaus, Barbara Keitel, Wiebke Laasch,  
Peter Schmäuser, Bernd Sonntag, Kai Tiedtke

### *Realization and editing*

Petra Folkerts  
Heike Becker; Ilka Flegel, Textlabor, Jena;  
Barbara Keitel; Frank Poppe

### *Design*

Jung von Matt/brand identity GmbH, Hamburg

### *Layout*

formlabor, Hamburg

### *Graphics*

Dirk Günther Grafik Design, Hamburg; formlabor, Hamburg

### *Photographs*

DESY; ISA, Aarhus, Denmark; Dirk Rathje, Hamburg;  
Manfred Schulze-Alex, Hamburg

### *Printing*

Heigener Europrint GmbH, Hamburg

### *Copy deadline*

May 2007

Reproduction including extracts is  
permitted subject to crediting the source.





## Deutsches Elektronen-Synchrotron Member of the Helmholtz Association

The Helmholtz Association contributes to solving major challenges facing society, science and the economy with top scientific achievements in six research areas: Energy, Earth and Environment, Health, Key Technologies, Structure of Matter, Transport and Space. With 25,700 employees in 15 research

centers and an annual budget of approximately 2.3 billion euro, the Helmholtz Association is Germany's largest scientific organisation. Its work follows in the tradition of the great natural scientist Hermann von Helmholtz (1821 - 1894).

[www.helmholtz.de](http://www.helmholtz.de)