

Code of Practice for the Electricity (Wiring) Regulations

2015 Edition



CODE OF PRACTICE
FOR THE
ELECTRICITY (WIRING) REGULATIONS

Electrical and Mechanical
Services Department
2015

Contents

	<i>Page</i>
Acknowledgements	9
Part I	
1. Introduction	10
2. Interpretation	11
3. Application	16
3A General Application of the CoP	17
3B Application to Category 2 Circuit	17
3C Exempted Fixed Electrical Installations	17
4. General Safety Requirements	18
4A General	19
4B Workmanship and Materials	20
4C Design, Construction, Installation and Protection	20
4D Identification, Maintenance, Inspection and Testing	21
4E Working Space	23
4F Switchroom/Substation	23
4G Safety Precautions for Work on Low Voltage Installation	25
4H Safety Precautions for Work on High Voltage Installation	27
4I General Safety Practices	33
5. Segregation of Circuit Categories	35
5A Circuit Category	36
5B Segregation of Category 1, 2 and 3 Circuits	36
5C Segregation of Category 4 Circuits and Circuits of Other Categories	37
5D Segregation of Circuits from Overhead Telecommunication Lines and Telephone Lines	38
6. Circuit Arrangement	40
6A Division of Installation into Circuits	41
6B Basic Requirements of Circuits	41
6C Ring Final Circuit Arrangement	42
6D Final Circuits Using 5A or 15A Socket Outlets to Requirements Prescribed in Appendix 1	43
6E Final Circuits Using 13A Socket Outlets to Requirements Prescribed in Appendix 2	43
6F Final Circuits Using 5A, 15A or 30A Industrial Socket Outlets to Requirements Prescribed in Appendix 3	44

6G	Final Circuits Using 16A Industrial Socket Outlets to Requirements Prescribed in Appendix 4	45
6H	Final Circuits Using 32A, 63A or 125A Industrial Socket Outlets to Requirements Prescribed in Appendix 4	45
6I	Protection Requirement of High Voltage Circuit	45
7.	Current Demand	52
7A	Current Demand of a Circuit	53
7B	Determination of Current Demand	53
8.	Isolation and Switching	56
8A	Provision of Isolation and Switching	57
8B	Requirements of Isolation and Switching Devices	60
9.	Overcurrent Protective Devices	64
9A	General Requirements	65
9B	Relation Between Circuit Conductors and Overcurrent Protective Devices	66
9C	Breaking Capacity of Overcurrent Protective Devices	67
9D	Position of Overcurrent Protective Devices	67
9E	Other Requirements of Overcurrent Protective Devices	68
10.	Neutral Conductor Protective Devices, Isolators and Switches	73
10A	Linked Circuit Breakers, Linked Isolators and Linked Switches	74
10B	Protection of Neutral Conductor	74
10C	Single-pole Switch in Earthing Conductor	74
11.	Earth Leakage and Earth Fault Currents	75
11A	General	76
11B	Basic Requirements	76
11C	Protective Conductors	77
11D	Earthing of Exposed Conductive Parts	78
11E	Equipotential Bonding	79
11F	Supplementary Bonding	80
11G	Main Earthing Terminal	81
11H	Earthing Conductor	82
11I	Earth Fault Loop Impedance (Z_s)	83
11J	Residual Current Device (RCD)	83
11K	Earth Electrodes	84

	<i>Page</i>
12. Earthing Arrangement	93
12A General	94
12B Bonding Connections to the Point of Supply	94
12C Earth Electrode	95
13. Conductors, Joints and Connections	97
13A Selection and Sizing of Cable Conductors	98
13B Basic Protection	100
13C Joints and Connections	100
13D Other Requirements of Cables	101
14. Wiring Installation Enclosure	104
14A General Requirements	105
14B Steel Conduit System	105
14C Steel Trunking System	106
14D Plastic or PVC Conduit or Trunking	107
14E Cable Capacity of Enclosures	108
14F Enclosures of Busbar Trunking System and Powertrack System	109
14G Workmanship	109
15. Adverse Conditions Installation	113
15A Presence of Water (AD) or High Humidity (AB)	114
15B Ambient Temperature (AA)	115
15C Presence of Corrosive or Polluting Substance (AF)	116
15D Installation Exposed to Fire or Explosion	117
15E Impact (AG)	118
15F Vibration (AH)	119
15G Other Mechanical Stresses	119
16. Overhead Line Installations	125
16A General	126
16B Installation of Overhead Lines	126
16C Joints of Overhead Lines	126
16D Service to Building	126
16E Conductor to Ground Clearance	126
16F Pole	127
16G Stay Wire	127
16H Carrier Wire	127
16I Earthing of Metallic Parts and Earth Leakage Protection	128

	<i>Page</i>
17. Display of Labels and Notices	129
17A Warning Notice for Substations and Switchrooms	130
17B Warning Notice for Connection of Earthing and Bonding Conductors	130
17C Warning Notice for Repair	131
17D Notice of Periodic Testing of Electrical Installations	131
17E Notice of Testing for Residual Current Devices	131
17F Warning Notice for Installation Having Both New and Old Cable Colours	132
18. Alterations and Additions	133
18A Requirements for Alterations or Additions to a Fixed Installation	134
18B Approval from the Electricity Supplier	134
19. First Inspection, Testing and Certification	135
19A Certification on Completion of an Installation	136
19B Work Completion Certificate	136
20. Periodic Inspection, Testing and Certification	138
20A Fixed Electrical Installations Specified in Regulation 20(1)	139
20B Fixed Electrical Installations Specified in Regulations 20(2), 20(3) and 20(4)	140
20C Periodic Test Certificate	141
21. Procedures for Inspection, Testing and Certification	142
21A Inspection of Low Voltage Installations	143
21B Testing of Low Voltage Installations	144
21C Inspection of High Voltage (H.V.) Installations	148
21D Testing of High Voltage Installations	149
21E Points to be Noted by Registered Electrical Workers	149
21F Power Suspension Arrangement for Periodic Inspection, Testing and Certification (PITC) Work on Main Switchboard connecting to Power Company's Transformer	151
22. Making and Keeping of Records	159
22A Keeping of Records by the Owner of an Electrical Installation that Requires Periodic Inspection, Testing and Certification	160
22B Making and Keeping of Records by a Registered Electrical Contractor	160
22C Types of Records	160
22D Checklists	160

23.	} (Reserved for Future Uses)	163
24.		

Part II

25.	General Workmanship	164
25A	Wiring Installation Using Conduits	165
25B	Wiring Installation Using Trunkings	167
25C	Installation of Cables	167
25D	Cable Joint and Cable Termination	170
25E	Installation of Socket Outlets	174
26.	Requirements for Specific Installations and Equipment	180
26A	Domestic Installation and Appliance	182
26B	Busbar Trunking Distribution System	187
26C	Electric Motor	189
26D	Supply Connection to Transformers	190
26E	Supply Connection to Welding Sets	191
26F	Installation of Fluorescent and Gaseous Discharge Lamps	191
26G	Installation of Category 3 Circuits	191
26H	High Voltage Discharge Lighting Installation (Neon Signs)	191
26I	Lightning Protection Installation	195
26J	Rising Mains Installation	195
26K	Temporary Supply Installation for Construction and Demolition Sites or Repair and Testing Purposes	195
26L	Hot Air Saunas Installation	198
26M	Swimming Pools and Fountains Installation	200
26N	Installation in Restrictive Conductive Locations	205
26O	Installation of Equipment Having High Earth Leakage Currents	207
26P	Renewable Energy Power System	209
26Q	Temporary Electrical Installation for Exhibitions, Shows, Stands and Festive Lighting	210
26R	Electric Heating Systems installed in Building Structures	212
26S	Charging Facilities for Electric Vehicles	212

	<i>Page</i>
Appendices	220
1. Prescribed Requirements for 3-pin (non-reversible) 5 ampere and 15 ampere Socket Outlets	221
2. Prescribed Requirements for 3-pin (non-reversible) 13 ampere Socket Outlets	229
3. Prescribed Requirements for Protected Type Non-reversible 5 ampere, 15 ampere and 30 ampere Socket Outlets	238
4. Prescribed Requirements for Industrial Type 16 ampere, 32 ampere, 63 ampere and 125 ampere Socket Outlets with Retaining Devices	248
5. Rating Factors for Sizing of Cable Conductors	264
6. Current Carrying Capacities and Voltage Drop Tables for PVC Insulated and XLPE Insulated Cables	268
7. Typical Methods of Installation of Cables	286
8. Graphical Symbols for Electrical Diagrams	290
9. Performance Monitoring Points System for Registered Electrical Workers / Contractors	298
10. Degree of Protection Provided by Enclosures (IP Code)	299
11. Forms of Internal Separations for Switchgear Assemblies	301
12. (Reserved for Future Uses)	303
13. Sample of Schedule of Test Results for Electrical Wiring and Checklists	305
14. References	325
15. Safety for Live Work	332
16. Sample of Permit-To-Work / Sanction-For-Test	335
17. Sample of H.V. Enclosure Log Book / H.V. Padlock Movement Log Book	339
18. New Cable Colour Code for Fixed Electrical Installations- Installation Guidelines	341
Index	347

ACKNOWLEDGEMENT

The Electrical and Mechanical Services Department of the Government of the Hong Kong Special Administrative Region would like to express gratitude to the organizations listed below for their kind permission to reproduce materials from their copyright publications:

- British Standards Institution (BSI)
- The Institution of Engineering & Technology (IET) (as the joint copyright holder with BSI for BS 7671—IEE Wiring Regulations)
- International Electrotechnical Commission (IEC)

The organizations listed above retain the copyright on the reproduced materials which may not be reproduced without the prior written permission the organizations. Copies of the complete standards listed above are available for sale from the respective organizations. The addresses of the organizations are:

- British Standards Institution:
389 Chiswick High Road, London W4 4AL, UK
- The Institution of Engineering & Technology:
Michael Faraday House, Six Hills Way, Stevenage, UK
- International Electrotechnical Commission:
IEC Central Office, 3 rue de Varemb , P.O. Box 131, CH-1211
Geneva 20, Switzerland

Copies of the complete standards can also be bought through the Product Standards Information Bureau, Innovation and Technology Commission at 36/F, Immigration Tower, 7 Gloucester Road, Wanchai, Hong Kong (tel. no.: 2829 4820).

PART I

Code 1 INTRODUCTION

This Code of Practice should be titled 'Code of Practice for the Electricity (Wiring) Regulations' hereinafter referred as the 'CoP'.

The CoP is published to give general technical guidelines on how the statutory requirements of the Electricity (Wiring) Regulations, hereinafter referred as the 'Wiring Regulations', can be met.

The structure of the CoP corresponds to that of the Wiring Regulations in that a code will be associated with a corresponding regulation of the Wiring Regulations. Additional codes are also included to describe general workmanship and requirements for specific installations and equipment.

Compliance with the CoP should achieve compliance with the relevant aspects of the Wiring Regulations. However, those installations or parts of installation which comply with 2009 edition of this CoP is also deemed to have met the requirements of the Wiring Regulations provided that they:

- (a) are completed and connected to electricity supplies before 30 November 2017; and
- (b) comply with the electricity supplier's Supply Rules.

Code 2 INTERPRETATION

In the CoP, in addition to all the definitions used in the Electricity Ordinance and its Regulations, the following definitions shall apply—

‘appliance’ means an item of current using equipment other than a luminaire or an independent motor or motorised drive.

‘appliance, fixed’ means an appliance which is fastened to a support or otherwise secured or placed at a specific location in normal use.

‘appliance, portable’ means an appliance which is or can easily be moved from one place to another when in normal use and while connected to the supply.

‘barrier’ means an effective means of physically preventing unauthorised approach to a source of danger.

‘basic protection’ means protection against dangers that may arise from direct contact with live parts of the installation

‘bonding’ means the permanent joining of metallic parts to form an electrically conductive path which will assure electrical continuity and has the capacity to conduct safely any current likely to be imposed.

‘bonding conductor’ means a protective conductor providing equipotential bonding.

‘bunched’ means two or more cables to be contained within a single conduit, duct, ducting or trunking or, if not enclosed, are not separated from each other.

‘busbar trunking system’ means a type-tested assembly, in the form of an enclosed conductor system comprising solid conductors separated by insulating material. The assembly may consist of units such as expansion units, feeder units, tap-off units, bends, tees, etc. Busbar trunking system includes busduct system.

‘cable channel’ means an enclosure situated above or in the ground, ventilated or closed, and having dimensions which do not permit the access of persons but allow access to the conductors and/or cables throughout their length during and after installation. A cable channel may or may not form part of the building construction.

‘cable coupler’ means a device enabling the connection or disconnection, at will, of two flexible cables. It consists of a connector and a plug.

‘cable ducting’ means a manufactured enclosure of metal or insulating material, other than conduit or cable trunking, intended for the protection of cables which are drawn-in after erection of the ducting, but which is not specifically intended to form part of a building structure.

'cable trunking' means a manufactured enclosure for the protection of cables, normally of rectangular cross section, of which one side is removable or hinged.

'circuit breaker' means a mechanical switching device capable of making, carrying and breaking currents under normal circuit conditions and also of making, carrying for a specified time, and breaking currents under specified abnormal circuit conditions, such as those of short circuit.

'circuit protective conductor' means a protective conductor connecting exposed conductive parts of equipment to the main earthing terminal.

'connector' means a device which is provided with female contacts and is intended to be attached to the flexible cable connected to the supply.

'danger' means a risk of bodily injury or loss of life or health from shock, burn, asphyxiation or other causes.

'dead' means at or about zero voltage and disconnected from any live system.

'duct' means a closed passage way formed underground or in a structure and intended to receive one or more cables which may be drawn in.

'earth electrode resistance' means the resistance of an earth electrode to earth.

'earth fault loop impedance' means the impedance of the earth fault current loop (phase to earth loop) starting and ending at the point of earth fault.

'earthed' means connected to the general mass of earth in such a manner as will ensure at all times an immediate discharge of electrical energy without danger; when applied to electrical equipment, all phases short-circuited and effectively connected to earth.

'earthing conductor' means a protective conductor connecting a main earthing terminal of an installation to an earth electrode or to other means of earthing.

'enclosure' means a part providing an appropriate degree of protection of equipment against certain external influences and a defined degree of protection against contact with live parts from any direction.

'equipment' means electrical equipment.

'equipotential bonding' means electrical connection putting various exposed conductive parts and extraneous conductive parts at a substantially equal potential.

'extra low voltage' means voltage normally not exceeding 50V root mean square alternating current or 120V direct current, between conductors or between a conductor and earth.

'fault protection' means protection against dangers that may arise from indirect contact with live parts of the installation (contact with an exposed conductive part that is not normally live but has become live under fault conditions).

'fuse element' means a part of a fuse designed to melt when the fuse operates.

'fuse link' means that part of a fuse, including the fuse element, which requires replacement by a new fuse link after the fuse element has melted and before the fuse can be put back into service.

'high voltage' means voltage normally exceeding low voltage.

'H.V. enclosure' means a substation, standby generator house, distribution centre and a room or other enclosure wherein high voltage apparatus is installed. 'Danger' notice shall be permanently affixed outside H.V. enclosure access doors.

'installation' means electrical installation.

'live' means electrically charged.

'live work' means electrical work on or near any live conductor. This is anywhere a worker is exposed to energised conductors, terminals, busbars or contacts.

'low voltage' means voltage normally exceeding extra low voltage but normally not exceeding: between conductors, 1000V root mean square alternating current or 1500V direct current, or between a conductor and earth, 600V root mean square alternating current or 900V direct current.

'overhead line' is defined in the Electricity (Wiring) Regulations as a conductor that is placed above ground and is suspended in the open air.

'PELV (Protective Extra-Low Voltage)' means an extra-low voltage system which is not electrically separated from earth, but which otherwise satisfies all the requirements for SELV.

'permit-to-work' means an official form signed and issued by a responsible person to a person having the permission of the responsible person in charge of work to be carried out on any earthed electrical equipment for the purpose of making known to such person exactly what electrical equipment is dead, isolated from all live conductors, has been discharged and connected to earth (if necessary), and on which it is safe to work.

'person in-charge' means a registered electrical worker of an appropriate grade assigned by a registered electrical contractor or the owner of fixed electrical installation to take charge of the carrying out of the electrical work for the installation.

'powertrack system' means an assembly of system components including a generally linear assembly of spaced and supported busbars by which accessories may be connected to an electrical supply at one or more points (pre-determined or otherwise) along the powertrack.

'protective conductor' means a conductor used for some measures of protection against electric shock and intended for connecting together any of the following parts:

- (i) exposed conductive parts,
- (ii) extraneous conductive parts,
- (iii) main earthing terminal,
- (iv) earth electrode(s),
- (v) the earthed point of the source, or an artificial neutral.

'residual operating current' means residual current which causes the residual current device to operate under specified conditions.

'responsible assessor' means a registered electrical worker of an appropriate grade or a registered professional engineer of Electrical/Building Services discipline or a registered safety officer assigned by a registered electrical contractor or the owner of fixed electrical installation to evaluate electrical safety on carrying out LIVE work and suggest appropriate control measures.

'responsible person' means a registered electrical worker of an appropriate grade appointed in writing by a registered electrical contractor or the owner of fixed electrical installation to operate and maintain the installation.

'restrictive conductive location' means a location comprised mainly of metallic or conductive surrounding parts, within which it is likely that a person will come into contact through a substantial portion of their body with the conductive surrounding parts and where the possibility of preventing this contact is limited.

'rising mains' means that part of the installation which is used for distribution of electricity throughout any building normally used for multiple occupation.

'sanction-for-test' means an official form signed and issued by a responsible person to a person having the permission of the responsible person in charge of the testing to be undertaken on any high voltage electrical equipment for

the purpose of making known to such person exactly what electrical equipment is to be tested, and the conditions during testing.

'screen' means an effective means of identifying or shielding the safe working area from a source of danger.

'SELV' (Separated Extra-Low Voltage) means an extra-low voltage which is electrically separated from earth and from other systems in such a way that single fault cannot give rise to the risk of electric shock.

'short circuit current' means an overcurrent resulting from a fault of negligible impedance between live conductors having a difference in potential under normal operating conditions.

'socket outlet' means a device, provided with female contacts, which is intended to be installed with the fixed wiring, and intended to receive a plug.

Code 3 APPLICATION

- 3A General Application of the CoP
- 3B Application to Category 2 Circuit
- 3C Exempted Fixed Electrical Installations

Code 3 APPLICATION

3A General Application of the CoP

- (a) The CoP applies to all low or high voltage FIXED electrical installations in buildings and premises including those of domestic and commercial buildings, factories and industrial undertakings, except fixed electrical installations which are:
- (i) exempted by the Director; or
 - (ii) in mobile units such as aircrafts, motor vehicles and sea-going vessels.
- (b) Gantry and tower cranes, hoists, conveyors, traction equipment and ropeways that are permanently connected to low or high voltage electricity supply are considered as fixed electrical installations. The wiring of such equipment is required to comply with the Wiring Regulations and the CoP applies to them.

3B Application to Category 2 Circuit

Category 2 circuits being supplied from a safety source, are not regulated by the Wiring Regulations (except regulation 5(1)).

3C Exempted Fixed Electrical Installations

- (a) Where the Director is satisfied that an owner is capable of safely installing and maintaining his own fixed electrical installation, the Director may, by order, exempt the owner, his electrical installations, his electrical workers or any combination of them, from any of the provisions of the Electricity Ordinance relating to electrical installations.
- (b) Although fixed electrical installations belonging to Government and those fixed electrical installations which are exempted by the Director are not required to comply with the Wiring Regulations or the CoP, owners of these installations are at liberty to have their installations complied with the whole or part of the Wiring Regulations and the CoP.

Code 4 GENERAL SAFETY REQUIREMENTS

- 4A General
- 4B Workmanship and Materials
 - (1) Workmanship
 - (2) Materials
- 4C Design, Construction, Installation and Protection
 - (1) Interchangeability of socket outlets
 - (2) Protection
- 4D Identification, Maintenance, Inspection and Testing
 - (1) Identification
 - (2) Maintainability
 - (3) Inspection and testing
- 4E Working Space
- 4F Switchroom/Substation
 - (1) Facilities for locking
 - (2) Arrangement of entrance/exit
 - (3) Illumination and ventilation
 - (4) Prohibition of storage
- 4G Safety Precautions for Work on Low Voltage Installation
 - (1) Work on low voltage installation
 - (2) Work involving the use of electric-arc welding set
 - (3) Precautions for supply connection
 - (4) Precautions for major alteration
 - (5) Use of ladder / working platform
 - (6) Use of portable equipment
- 4H Safety Precautions for Work on High Voltage Installation
 - (1) General
 - (2) Access to H.V. enclosures
 - (3) Work on H.V. electrical equipment
- 4I General Safety Practices

Code 4 GENERAL SAFETY REQUIREMENTS

4A General

- (1) All equipment which is designed, constructed and manufactured to relevant national/international standards or specifications recognised by the Director, and so certified by the national/international organisations or any testing and certification authorities recognised or approved by the Director, is considered to have been properly designed and constructed with good workmanship and suitable materials.
- (2) Relevant national/international standards and organisations currently recognised by the Director are listed in Table 4(1).
- (3) For the purpose of product testing and certification, the test certificates or reports issued by the following organisations are recognised by the Director:
 - (a) CB test certificates issued by national certification bodies participating in the IECEE (IEC System for Conformity Testing and Certification of Electrical Equipment) CB Scheme;
 - (b) Endorsed test certificates or reports, bearing the accreditation mark of HKAS/ HOKLAS, issued by laboratories accredited by Hong Kong Accreditation Service (HKAS) or Hong Kong Laboratory Accreditation Scheme (HOKLAS) for the relevant tests;
 - (c) Endorsed test certificates or reports issued by laboratories that have been accredited by accreditation bodies which have mutual recognition arrangements with HKAS/HOKLAS. The up-to-date list of accreditation bodies which have mutual recognition agreements/arrangements with HOKLAS/HKAS can be found at the website of the Innovation and Technology Commission: <http://www.itc.gov.hk>.
- (4) Relevant short circuit testing organisations currently recognised by the Director are:
 - (a) The Association of Short Circuit Testing Authorities (ASTA);
 - (b) N.V. tot Keuring van Elektrotechnische Materialen (KEMA);
 - (c) Association des Stations d'Essais Francaises d'Appareillage (ASEFA);
 - (d) An accredited laboratory in subparagraph 3 above;
 - (e) Other short circuit testing authorities internationally recognised as having equal standing as ASTA.

4B **Workmanship and Materials**

(1) Workmanship

- (a) Good workmanship should be used in the construction and installation of every electrical installation.
- (b) Descriptions of general workmanship are given in Code 25 of the CoP.
- (c) Particular attention should be paid to the workmanship employed in making joints, terminations and enclosures for the wiring installations. Reference should also be made to relevant sections in this CoP:
 - Code 13—Conductors, Joints and Connections
 - Code 14—Wiring Installation Enclosure

(2) Materials

- (a) All materials chosen and used in an electrical installation should be purposely designed for the intended application and should not cause harmful effects to other equipment, undue fire risk or electrical hazard.
- (b) Special consideration should be given in choosing materials purposely designed for electrical installations which are:
 - (i) exposed to weather, water, corrosive atmospheres or other adverse conditions;
 - (ii) exposed to flammable surroundings or explosive atmosphere.

Descriptions of installation in adverse environmental conditions are given in Code 15.

4C **Design, Construction, Installation and Protection**

(1) Interchangeability of socket outlets

To ensure proper matching and interchangeability, socket outlets should be designed, constructed and manufactured to the requirements given in appendices 1, 2, 3 and 4. Socket outlets of standards mentioned in Table 4(1) which have identical physical dimensions and configurations as those shown in appendices 1, 2, 3 and 4 are also acceptable.

(2) Protection

- (a) Electrical equipment should be mechanically and electrically protected so as to prevent danger from shock, burn, or other injury to person or damage to property or from fire of an electric origin.
- (b) Mechanical protection includes the provision of barriers, enclosures, protective covers, guards and means of identification, the display of

warning notices and the placing of equipment out of reach. Where it is necessary to remove barriers or open enclosures, protective covers, guards, this should be possible only by use of a key or tool.

- (c) Electrical protection includes the provision of isolation, protective devices and earthing facilities as well as equipotential bonding of all the exposed conductive parts and extraneous conductive parts.
- (d) Electrical equipment should be so selected and erected that its temperature in normal operation and foreseeable temperature rise during a fault cannot cause a fire.
- (e) Suitable precautions should be taken where a reduction in voltage, or loss and subsequent restoration of voltage, could cause danger.

4D Identification, Maintenance, Inspection and Testing

(1) Identification

- (a) Each switch, fuse switch, switch fuse, busbar chamber, checkmeter and distribution board should be properly labelled on the front cover to indicate the circuit name or number, the rating of the fuse or circuit breaker, and the purpose of each circuit (e.g. lighting, socket outlet, pumps, lifts etc.). For fuses and circuit breakers fitted in a distribution board which are not visible without opening or removing the front cover of the distribution board, labels should be fixed inside the distribution board in such a manner as to allow easy identification of the individual fuses or circuit breakers when the front cover is opened or removed. The use of colour and / or coding for phase identification of switchgear / distribution board should be in accordance with Table 13(2) in so far as these are applicable.
- (b) For the live parts of an item of equipment or enclosure, e.g. a heater inside an electric motor, which are not capable of being isolated by a single device or not provided with an interlocking arrangement to isolate all circuits concerned, a label should be fixed in such a position so as to warn any person gaining access to the live parts, of the need to take special precautionary measures and to operate the designated isolating devices.
- (c) Labels should be legible and durable. They should be securely fixed to the equipment. Engraved labels and paper labels with a cover sheet of rigid transparent plastic, permanently glued or fixed to the surface of the equipment are also acceptable. For indoor application, the use of paint marking on the equipment is also acceptable. The use of insulation or adhesive tapes for the fixing of labels is not acceptable. Each character or letter printed or engraved on the label should not be less than 5 mm high.

(d) Labels for identification purposes should preferably be written in both Chinese and English. Warning labels must be written in both Chinese and English.

(2) Maintenance

- (a) In the design, construction and installation of an electrical installation, consideration must be given to its subsequent maintenance. It should be noted that electrical equipment must not only be so constructed and protected as to be suitable for the conditions under which they are required to operate, but must also be installed to be capable of being maintained, inspected and tested with due regard to safety.
- (b) For the purpose of maintenance, it is important to ensure the safety of persons approaching electrical equipment to work on it or attend to it. Guidelines on the provision of adequate and safe means of access and working space are described in Codes 4E and 4F.

(3) Inspection and testing

- (a) On completion of an installation or an extension of an installation, appropriate tests and inspection shall be made, to verify so far as is reasonably practicable that the requirements of the Wiring Regulations have been met.
- (b) The power factor measured at consumer's supply point of a consumer's load should be maintained at a minimum of 0.85 lagging and necessary power factor correction equipment should be installed.
- (c) An assessment should be made of any characteristics of equipment likely to have harmful effects upon other electrical equipment or other services, or impair the supply. Those characteristics include the following:
- overvoltages;
 - undervoltages;
 - fluctuating loads;
 - unbalanced loads;
 - power factor;
 - starting currents;
 - harmonic currents;
 - d.c. feedback;
 - high-frequency oscillations;
 - necessity for additional connection to earth.

4E **Working Space**

- (a) A minimum clearance space of 600 mm should be provided for the full width and in front of all low voltage switchgear having a rating not exceeding 100 amperes, such as consumer units and isolation switches.
- (b) A minimum clearance space of 900 mm should be provided for the full width and in front of meters and of all low voltage control panels and switchgear having a rating exceeding 100 amperes, such as switchboards, distribution panels, and motor control centres.
- (c) A minimum clearance space of 600 mm is required behind or by the side of such equipment where access from behind or the side is required for connection and maintenance purposes.
- (d) Clearance space may not be provided behind or by the side of such equipment where there are no renewable parts such as fuses or switches and no parts or connections which require access from the back or from the side concerned.
- (e) The clearance space in front of the equipment referred to in subparagraph (b) should be increased to at least 1 400 mm for such electrical equipment operating at high voltage.
- (f) The clearance space referred to in subparagraph (a), (b) or (e) should not be less than the space required for the operation of draw-out type equipment or for the opening of enclosure doors or hinged panels to at least 90 degrees.
- (g) The minimum height of all clearance space(s) referred to in subparagraph (a) should not be less than 1 000 mm measured from the footing and those referred to in subparagraphs (b), (c) or (e) and (f), should not be less than 1 800 mm measured from the footing. Under normal operational conditions, where bare live parts are exposed, the minimum height of all such clearance spaces should not be less than 2 100 mm.

4F **Switchroom/Substation**

(1) *Facilities for locking*

- (a) Every switchroom or substation should have suitable means of entrance/exit, which should be so arranged as to prevent unauthorised entry but give authorised persons ready access at all times. For the purpose of preventing unauthorised entry, or access to low voltage installations, the display of suitable warning notice is acceptable provided that the equipment is not readily accessible to the general public. In the case of high voltage installations, locked enclosure with suitable warning notice should be provided.

- (b) Where an entrance or exit of a switchroom/substation is provided with locked doors or gates, the arrangement of the lock should be such that it requires a key to open the door or gate from outside.
- (c) Every high voltage (H.V.) switchroom/substation, except when manned, should be kept locked. A duplicate key for each H.V. switchroom/substation should be available, for emergency purposes, in a key box at a designated location. All other keys for use in the H.V. switchroom/substation should be kept under the control of a responsible person.
- (d) Exceptionally, a key may be held by a person whose duties require him to have frequent access to an H.V. switchroom/substation. In such a case, that person should obtain a written authorisation from the responsible person stating the duties for which the person is required to hold the key.

(2) *Arrangement of entrance/exit*

- (a) At least one exit of a switchroom/substation should open outwards and this emergency exit should be identified clearly.
- (b) Conductors near the entrance/exit of a switchroom/substation must be so arranged or protected that there is no risk of accidental contact of any live metal by any person entering or leaving.
- (c) In order to provide free and ready access at all times for the maintenance and operation of the electrical equipment contained in a switchroom/substation, every entrance/exit of a switchroom/substation should be kept free of any obstruction including
 - (i) locking facilities other than those in accordance with paragraph (1);
 - (ii) structures/goods/materials and
 - (iii) litter or waste,which impedes the access to the switchroom/substation from a public area.

(3) *Illumination and ventilation*

- (a) Suitable lighting giving a minimum illumination level of 150 lux measured at floor level in each switchroom/substation and an average vertical illumination level of 120 lux minimum should be provided to allow for the proper operation of electrical equipment. Where electrical equipment in the switchroom/substation is required to be operated in case of mains power failure, adequate emergency electric lighting independent of the mains supply and capable of operation for a minimum period of 30 minutes should be provided.

Additional lighting should be provided during maintenance if only the above minimum level of illumination is provided.

- (b) Suitable ventilation or air-conditioning should be provided so as to prevent the development of high ambient air temperatures around the electrical equipment in excess of those permissible for such equipment.

(4) *Prohibition of storage*

Switchroom/substation, other than the tools used for the operation and maintenance of the switchgear inside it, must not be used for storage purposes.

4G **Safety Precautions for Work on Low Voltage Installation**

(1) *Work on low voltage installation*

- (a) A registered electrical contractor should appoint a responsible registered electrical worker of appropriate grade to take charge of electrical work to ensure the quality of the electrical installations and safety of the work.
- (b) Suitable and adequate personal protective equipment and proper tools should be used in carrying out electrical work. A list of standards for common personal protective equipment and tools for electrical work is given in Appendix 14.
- (c) Where practicable, work on low voltage electrical equipment should be carried out after the electrical equipment has been isolated.
- (d) The conditions and safety precautions for live work are stated in Appendix 15.
- (e) Where danger cannot be avoided for work on energised equipment, the electrical equipment should be isolated and verified dead with a voltage indicator; a permit-to-work (sample shown in Appendix 16) should be issued.
- (f) Where work is to be done on dead low voltage electrical equipment, controlled by a circuit breaker or switch, the circuit breaker or switch should be locked off where practicable and a warning notice for repair affixed. The keys for locks used to lock off circuit breaker or switch should be kept under the control of a responsible person.

(2) *Work involving the use of electric-arc welding set*

- (a) Welders should be properly trained to avoid direct contact with exposed energised parts of an electrode clamp or a welding rod such as by wearing protective clothing and gloves.

- (b) The work piece to be welded should be effectively and electrically connected to the welding return before welding work is commenced.

(Note: Please refer to the relevant code of practices /guidelines of the Labour Department)

(3) *Precautions for supply connection*

Temporary or permanent supply should not be connected to a circuit unless:

- (a) the circuit and its final circuits, if any, are completed and properly terminated, or
- (b) the part(s) of the circuit or its final circuits which have not been completed, are disconnected or isolated with its associated isolating devices locked off.

(4) *Precautions for major alteration*

Before a major alteration is carried out on a circuit such as repositioning of a circuit, the circuit should be either:

- (a) disconnected from the supply source at the distribution board concerned; or
- (b) isolated with the isolating device locked off or its operation handle removed. The key or the handle, being non-interchangeable with any others which are used for a similar purpose for other parts of the installation, should be kept by the responsible person.

(5) *Use of ladder/ working platform*

A ladder made of wood or other non-conductive material should preferably be used on electrical work. Where electrical work cannot be safely done on or from the ground or from part of a permanent structure, suitable non-conductive working platforms (for details, please refer to the publications issued by the Labour Department) should be used.

(6) *Use of portable equipment*

Portable equipment of electrical work should be regularly checked and maintained, especially for the connections at the plug, to ensure that the equipment are in safe working order at all times.

(Note: Please refer to the relevant guidelines of the Labour Department)

4H **Safety Precautions for Work on High Voltage Installation**

(1) *General*

- (a) Precautionary measures, including those applicable ones stated in Code 4G, should be taken and the procedure of work should be such that no danger to persons or property will occur.
- (b) Work procedure for High Voltage Installations should be referred to subparagraph (2) and (3) below, and relevant international standards, manufacturers' recommendation, operations and maintenance instructions.
- (c) Appoint a responsible person to take charge of the operation and maintenance work of the installation.
- (d) Equipment that is considered by a responsible person to be in a dangerous condition should be isolated elsewhere and action taken to prevent it from being reconnected to the electricity supply.

(2) *Access to H.V. enclosures*

- (a) No person, except a responsible person or a person having the permission of the responsible person, should enter a H.V. enclosure, and where danger may exist, no one should enter a H.V. enclosure unaccompanied. The areas containing exposed H.V. live conductors, connected test equipment or test connection should be screened or fitted with barrier with appropriate label / sign attached to avoid unauthorized access.
- (b) Every H.V. enclosure, except where manned, should be kept locked. The access door key for entering the H.V. enclosures should be kept under the control of a responsible person and a duplicate key should also be kept in a lockable key cabinet located in the general office or plant manager room of each plant or depot. The key of the lockable cabinet should be issued to the responsible person. When the responsible person is off from his duty he should hand over all keys to his relief.
- (c) Exceptionally, a key may be held, subject to subparagraph 2(a) above, by a person having the permission of the responsible person whose duties required him to have frequent access to a H.V. enclosure. In such case, a responsible person should issue a written authority on which should be stated the duties for which the person having the permission of the responsible person holds the key.
- (d) A separate key cabinet should be provided in a H.V. enclosure containing keys for locks used to lock out isolators or switches or

to lock switchgear in earthed position or other safety devices inside the enclosure. The cabinet should be equipped with hooks labelled to match the items of equipment and should be locked with a master lock. Key of the master lock of equipment safety key box should be issued to responsible person only. A log book (sample shown in Appendix 17(A)) should be maintained inside the key box to record time, date and details of the padlock movements. Another log book (sample shown in Appendix 17(B)) should also be kept inside the H.V. enclosure to record time, date and details of the access to the enclosure.

- (e) At all times where inspection or work is to be carried out inside a H.V. enclosure installed with fixed automatic fire fighting system using gas extinguishing system, the fire fighting system should be key-switched to the "Manual" mode. Upon completion of work or inspection, the gas extinguishing system should be reverted to "Auto" mode, after ensuring that all personnel have left the H.V. enclosure and that the access doors have been closed and locked.

(3) *Work on H.V. electrical equipment*

- (a) Work (except for the case where Sanction-for-Test is issued with only the test voltage encountered) involving the handling of live parts or working within touchable distance, direct or indirect, of live parts, is not permitted.
- (b) No person should carry out maintenance, repair, cleaning and testing on any part of high voltage electrical equipment unless such parts of the electrical equipment are:
 - (i) dead;
 - (ii) isolated from live conductors and all practical steps taken to lock off from live sources;
 - (iii) effectively earthed at all points of disconnection of supply to such apparatus or between such points and the points of work;
 - (iv) fixed with warning notices for repair, barriers and/or screens; and
 - (v) released for work by issue of a permit-to-work (sample shown in Appendix 16(A)) or sanction-for-test (sample shown in Appendix 16(B)) whichever is applicable.

All working on, or testing of, high voltage equipment connected to a system should be authorised by a permit-to-work or a sanction-for-test respectively following the procedures set out in Code 21D. It is the duty of the responsible person to ensure that all the foregoing provisions are complied with prior to the issue of the permit-to-work or sanction-for-test.

- (c) No hand or tool (unless the tool has been designed for the purpose) should make contact with any high voltage conductor unless that conductor has been confirmed dead by responsible person.
- (d) Where the procedures involve the application of circuit main earths, the unauthorised removal of such earths should be prevented, wherever practicable, by the application of safety locks.
- (e) The spiking of cables must only be carried out by a person who has been specifically trained in the operation of the equipment in the presence of the Person in-charge.
- (f) Voltage transformers must not be removed or replaced if any of the windings are energised. If they need to be removed, the equipment supplying the voltage transformer must be isolated and made dead.
- (g) When withdrawable electrical equipment has been disconnected from all supplies and withdrawn from its normal live position, its conductors must be discharged to earth but need not remain connected to earth. The enclosure and any shutters should be locked off.
- (h) Before work is carried out on remotely or automatically controlled equipment such as circuit breakers, isolators, tap-changing gear or associated air compressors, all remote-control and automatic features should first be rendered inoperative. No work must be carried out on the controlling equipment, wiring or relays except by responsible person or person in-charge working under the personal supervision of the responsible person.
- (i) When work or test is to be carried out on busbar spouts of multi-panel switchboard, the following operations should be carried out in strict sequence:
 - (i) responsible person should issue Permit-to-Work to cover the work to be done or Sanction-for-Test to cover the test to be conducted;
 - (ii) the section of the busbar spouts on which work is to be carried out must be isolated from all points of supply from which it can be made live;
 - (iii) the isolating arrangements should be locked so that they cannot be operated, and shutters of live spouts locked shut. Caution signs should be fixed to the isolating points;
 - (iv) where applicable, danger signs should be attached on or adjacent to the live electrical equipment at the limits of the zone in which work is to be carried out;
 - (v) busbars should be checked by means of an approved voltage indicator to verify that they are dead, the indicator itself being tested immediately before and after use. The checking with the

- voltage indicator should be done on the panel to which the circuit main earths are to be applied. This test should also be made on the panel on which the work is carried out;
- (vi) circuit main earths should be applied at a panel on the isolated section of the busbar other than that at which work is to be done using the method recommended by the switchgear manufacturers. The insertion of hands or any tool into the contact spouts for this purpose is not an acceptable practice;
 - (vii) an earth connection should also be applied to a point as near to the point-of-work as possible;
 - (viii) during the course of the work, where applicable, the earth connection(s) at the point-of-work may be removed one phase at a time. Each phase earth connection must be replaced before a second-phase earth connection is removed;
 - (ix) on completion of the work, the permit-to-work should be cancelled.
- (j) When work or test is to be carried out on feeder or voltage transformer spouts, or on busbar spouts of a single panel, the following operations should be carried out in strict sequence:
- (i) responsible person should issue Permit-to-Work to cover the work to be done or Sanction-for-Test to cover the test to be conducted;
 - (ii) the spouts on which work is to be carried out must be isolated from all points of supply from which they can be made live;
 - (iii) the isolating arrangements should be locked so that they cannot be operated, and the shutters of live spouts should be locked shut. Caution signs should be fixed to all isolating points;
 - (iv) where applicable, danger signs should be attached on or adjacent to the live electrical equipment at the limits of the zone in which work is to be carried out;
 - (v) spout contacts should be checked by means of an approved voltage indicator to verify that they are dead, the indicator itself being tested before and after use;
 - (vi) the circuit should be earthed with approved earthing equipment at the point-of-work and where practicable at all points of the isolation from the supply. For the purpose of earthing metal-clad switchgear, approved appliances should only be used. The insertion of hands or any tools into contact spouts for this purpose is not an acceptable practice;
 - (vii) during the course of the work, where practicable, the earth connection(s) at the point-of-work may be removed one phase at a time. Each phase earth connection must be replaced before a second-phase earth connection is removed;

- (viii) on completion of the work, the permit-to-work should be cancelled.
- (k) When work or test is to be carried out on the connections to, or the windings of, a distribution transformer:
 - (i) responsible person should issue Permit-to-Work to cover the work to be done or Sanction-for-Test to cover the test to be conducted;
 - (ii) the switchgear or fuse gear controlling the high voltage windings should be switched off, and a safety lock and caution sign fitted;
 - (iii) the switch or isolator controlling the low voltage windings of the transformer should be switched off, and a safety lock and caution sign fitted, or other physical means should be used to prevent the switch being energised during the course of work;
 - (iv) where applicable, danger signs should be attached on or adjacent to the live electrical equipment at the limits of the zone in which work is to be carried out;
 - (v) the transformer should be proved dead at the points-of-isolation if practicable;
 - (vi) an earth should then be applied to the high voltage winding via the switchgear and a safety lock fitted. If the proprietary earthing gear is available for the low voltage switchgear, it should be fitted and safety locks applied (it is advisable to retest for dead before fitting this earthing gear);
 - (vii) before a permit-to-work is issued – responsible person should, at the point-of-work in the presence of the person in-charge, identify and mark the transformer to be worked on. The permit-to-work and the key to the key safe should then be issued to person in-charge;
 - (viii) if the conductors of the transformer are exposed during the work – responsible person should confirm dead via a high voltage indicator to the satisfaction of person in-charge before any physical contact is made;
 - (ix) The transformer must be isolated from all common neutral earthing equipment from which it may become live. This does not require the disconnection of solidly earthed neutrals or neutral equipment connected solely to the transformer on which work is to be done.
- (l) When work or test is to be carried out on the connections to, or the windings of, a generator:
 - (i) responsible person should issue Permit-to-Work to cover the work to be done or Sanction-for-Test to cover the test to be conducted;

- (ii) the switchgear supplied by the high voltage windings should be switched off and a safety lock and caution sign fitted. Care should be taken to ensure that any auxiliary supplies are also isolated with safety locks and caution signs are fitted;
 - (iii) the engine starting mechanism should be inhibited and safety locks and caution signs fitted. Caution signs should be fitted to the engine start panel;
 - (iv) where applicable, danger signs should be attached on or adjacent to the live electrical equipment at the limits of the zone in which work should be carried out;
 - (v) the generator should be proved dead at the points-of-isolation if practicable;
 - (vi) an earth should then be applied to the high voltage winding via the switchgear and a safety lock fitted;
 - (vii) before a permit-to-work is issued – the responsible person should, at the point-of-work in the presence of the person in-charge, identify and mark the generator to be worked on. The permit-to-work and the key to the key safe should then be issued to the person in-charge;
 - (viii) if the conductors of the generator are exposed during the work – responsible person should confirm dead via a high voltage indicator to the satisfaction of the person in-charge before any physical contact is made.
- (m) Before a permit-to-work or a sanction-for-test is issued, responsible person should identify the equipment on which the work or test is to be undertaken. If the work involves, or may involve, obtaining access to items of equipment over which confusion could occur, the responsible person should identify such items to person in-charge and apply temporary marking to them.
- (n) Before issuing a permit-to-work or sanction-for-test, responsible person should show the person in-charge the isolation and earthing arrangement and indicate the safety arrangements at the points-of-isolation and at the point-of-work or test. Responsible person should ensure that the person in-charge understands all the relevant safety procedures and precautions. If the person in-charge thereafter accepts the permit or sanction, that person becomes responsible for the defined work or test until the permit or sanction is cancelled.
- (o) Responsible person undertaking tasks requiring permits-to-work or sanctions-for-test becomes the person in-charge. All such documents must be countersigned by another responsible person before the work or test starts.

4| **General Safety Practices**

Codes 4G, 4H and other requirements mentioned elsewhere in the CoP are safety practices to be observed for work on electrical equipment. In addition, the following general safety practices should be observed for work on electrical equipment:

(a) *Check before Act*

The scope of work and relevant circuit should be checked before starting any electrical work. Suitable lighting and adequate illumination should be provided for the workplace. The condition of tools and instruments should also be checked before carrying out electrical work.

(b) *Isolate and Lockout*

The circuit / equipment under maintenance should be isolated as far as practicable. The relevant isolator should be locked out. A suitable warning notice should be placed close to the isolator.

(c) *De-energize*

The circuit/equipment to be worked on should be checked to ensure that it is dead.

(d) *Others*

- (i) The workplace should be kept clean and tidy.
- (ii) Keep hands away from any circuit or equipment or extraneous conductive parts that are not being worked on.
- (iii) Unauthorized people should not stay in the work place.
- (iv) The requirements stated in any related safety procedures and checklists should be followed.
- (v) Electrical installations, including but not limited to those newly installed, maintained, repaired or tripped under fault conditions, should be properly inspected and tested prior to energisation.

Table 4(1)

List of Standards and Organisations Recognised by the Director

Recognised National/ International Standards	(i) International Electrotechnical Commission Standards (IEC) (ii) Guo Biao (GB) (iii) British Standards (BS) (iv) Standards approved by the International Commission on Rules for the Approval of Electrical Equipment (CEE) (v) European Standards (EN) Harmonization Document (HD) (vi) American National Standards (ANS) (vii) Japanese Industrial Standards (JIS) (viii) Australian Standards (AS)
Recognised National Organisations	(i) International Electrotechnical Commission (ii) Standardization Administration of China (iii) British Standards Institution (iv) International Commission on Rules for the Approval of Electrical Equipment (v) European Committee for Electrotechnical Standardization CENELEC (vi) American National Standards Institute (vii) Japanese Standards Association (viii) Standards Australia

Code 5 SEGREGATION OF CIRCUIT CATEGORIES

5A Circuit Category

5B Segregation of Category 1, 2 and 3 Circuits

(1) General

(2) Category 1 and Category 2 circuits (with enclosures)

(3) Category 3 and Category 1 & 2 circuits (with enclosures)

(4) Category 1, 2 and 3 circuits without enclosure or underground

5C Segregation of Category 4 Circuits and Circuits of Other Categories

5D Segregation of Circuits from Overhead Telecommunication Lines and Telephone Lines

Code 5 SEGREGATION OF CIRCUIT CATEGORIES

5A Circuit Category

- (a) There are 4 categories of circuit as defined in the Wiring Regulations as follows:
- (i) Category 1 circuit means a circuit that operates at low voltage, but does not include a Category 3 circuit;
 - (ii) Category 2 circuit means a circuit for telecommunication, radio, telephone, sound distribution, intruder alarm, bell and call, or data transmission which is supplied with electricity from a safety source, but does not include a Category 3 circuit;
 - (iii) Category 3 circuit means a circuit for emergency lighting, exit signs, air pressurisation systems and fire services installations including fire detection and alarm, fire pumps, fireman's lifts and smoke extraction; and
 - (iv) Category 4 circuit means a high voltage circuit.
- (b) A safety source referred to in subparagraph (a)(ii) above means:
- (i) a double-insulated safety isolating transformer to BS EN 61558 or equivalent with its secondary winding being isolated from earth, and having a nominal output voltage not exceeding 55 V; or
 - (ii) a source of electricity providing a degree of safety equivalent to that of the safety isolating transformer referred to in (i) above (e.g. a motor-generator with windings providing equivalent isolation); or
 - (iii) a source providing electricity at a voltage not exceeding extra low voltage and independent of a higher voltage circuit.
- (c) Cables used to connect the battery chargers of self-contained luminaires to the normal mains circuit should NOT be considered as emergency lighting circuits under Category 3 circuit.

5B Segregation of Category 1, 2 and 3 Circuits

(1) General

- (a) Low voltage circuits should be segregated from extra-low voltage circuits.
- (b) Fire alarm and emergency lighting circuits should be segregated from all other cables and from each other in accordance with BS 5839 and BS 5266 or equivalent.
- (c) Telecommunication circuits should be segregated in accordance with BS 6701, BS EN 50174 or equivalent.

(2) Category 1 and Category 2 circuits (with enclosures)

- (a) Segregation between Category 1 and Category 2 circuits (with enclosures) should be in compliance with one of the permissible arrangements listed in Table 5(1).

- (b) In conduit, duct, ducting or trunking systems, if common boxes, switchplates or blocks are used for mounting controls or outlets for Category 1 and Category 2 circuits, rigid partition screens or barriers should be provided between the cables and connections of the two categories of circuits.
- (3) *Category 3 and Category 1 & 2 circuits (with enclosures)*
- (a) Segregation between Category 3 and Category 1 & 2 circuits (with enclosures) should be in compliance with one of the permissible arrangements listed in Table 5(2).
 - (b) Cables of Category 1 circuits are not allowed to be drawn into the same conduit, duct or ducting as cables of Category 3 circuits.
 - (c) Cores of Category 1 and Category 3 circuits are not allowed to be contained in a common multicore cable, flexible cable or flexible cord.
- (4) *Category 1, 2 and 3 circuits without enclosure or underground*

For cables of Category 1, 2 and 3 circuits that are installed without enclosure or underground, the following requirements should be observed:

- (a) A minimum horizontal and vertical separation distance of 50 mm should be provided between Category 1, 2 and 3 circuits.
- (b) For cables laid underground or in trench, if the separation distance of 50 mm cannot be achieved, a separation distance of not less than 25 mm is acceptable provided slabs of concrete are inserted between Category 1, 2 and 3 circuits. The slabs should be of such width and length that at every point, the shortest path between the circuits round the concrete should exceed 75 mm.
- (c) At point(s) of crossing for surface wiring of Category 1, 2 and 3 circuits, a bridge of durable insulating material at least 6 mm thick should be used for separation of circuits. The bridge should overlap the cables of those circuits by at least 25 mm on either side of the point of crossing.

5C **Segregation of Category 4 Circuits and Circuits of Other Categories**

- (a) Cables of Category 4 circuits are not allowed to be drawn into the same conduit, duct, ducting or trunking as cables of other circuit categories.
- (b) Cores of Category 4 circuits and cores of other circuit categories are not allowed to be contained in a common multicore cable, flexible cable or flexible cord.
- (c) For cables of Category 4 that are installed underground or without any enclosure, the following points should be observed:

- (i) A minimum horizontal or vertical separation distance of 300 mm should be provided between Category 4 circuits and circuits of other categories.
- (ii) For cables laid underground, if the separation distance of 300 mm cannot be achieved, a reduced separation is acceptable provided a slab of concrete is inserted between the circuits. The slab should be at least 50 mm thick and of such width and length that at every point, the shortest path between the circuits round the concrete should exceed 180 mm.

5D Segregation of Circuits from Overhead Telecommunication Lines and Telephone Lines

For overhead telecommunication and telephone lines, reference should be made to relevant Codes of Practice and guidelines issued by relevant authorities.

Table 5(1)

Permissible Arrangements for Segregation of Category 1 and Category 2 Circuits (With Enclosures)

Method of Installation	Conditions to be complied with
Different conduits, ducts, ductings or trunkings	—
Common conduit, duct or ducting	Cables of Category 2 circuits should be insulated for the highest voltage present in the Category 1 circuits
Common channel or trunking	(a) Cables of Category 2 circuits should be effectively partitioned from cables of Category 1 circuits <i>OR</i> (b) Cables of Category 2 circuits should be insulated for the highest voltage present in the Category 1 circuits
Common multicore cable, flexible cable or flexible cord	(a) Cores of Category 2 circuits should be separated from cores of Category 1 circuits by an earthed metal screen of equivalent current carrying capacity to that of the cores of the Category 1 circuits <i>OR</i> (b) Cores of Category 2 circuits should be insulated, individually or collectively as a group, for the highest voltage present in the Category 1 circuits

Table 5(2)

*Permissible Arrangements for Segregation of
Category 3 and Category 1 & 2 Circuits (With Enclosures)*

Method of Installation	Conditions to be complied with
Different conduits, ducts, ductings or trunkings	—
Common channel or trunking	<p>(a) Cables of Category 3 circuits should be segregated from circuits of other categories by continuous partitions and these partitions should also be provided at any common outlets OR</p> <p>(b) Where mineral insulated cables or cables whose performance complies with BS 6387 are used for Category 3 circuits, such a partition is not normally required</p>

Code 6 CIRCUIT ARRANGEMENT

- 6A Division of Installation into Circuits
- 6B Basic Requirements of Circuits
 - (1) Protection
 - (2) Control
 - (3) Identification
 - (4) Electrical separation for essential circuits
 - (5) Load distribution
 - (6) Arrangement of neutral conductor
- 6C Ring Final Circuit Arrangement
- 6D Final Circuits Using 5A or 15A Socket Outlets to Requirements Prescribed in Appendix 1
- 6E Final Circuits Using 13A Socket Outlets to Requirements Prescribed in Appendix 2
 - (1) General
 - (2) Spurs
 - (3) Separate circuits
 - (4) Permanently connected equipment
- 6F Final Circuits Using 5A, 15A or 30A Industrial Socket Outlets to Requirements Prescribed in Appendix 3
 - (1) Socket outlets
 - (2) Accepted practice
- 6G Final Circuits Using 16A Industrial Socket Outlets to Requirements Prescribed in Appendix 4
 - (1) Socket outlets
 - (2) Accepted practice
- 6H Final Circuits Using 32A, 63A or 125A Industrial Socket Outlets to Requirements Prescribed in Appendix 4
 - (1) Socket outlets
 - (2) Accepted practice
- 6I Protection Requirement of High Voltage Circuit

Code 6 CIRCUIT ARRANGEMENT

6A Division of Installation into Circuits

- (a) An electrical installation should be divided into circuits where necessary or practicable and each circuit should be separately protected and controlled.
- (b) A schematic wiring diagram showing the main distribution system should be displayed near the main switch with rating 100A or above.

6B Basic Requirements of Circuits

(1) Protection

- (a) Each circuit should be protected by an overcurrent protective device with its operating current value closely related to the current demand of the current using equipment connected or intended to be connected to it and to the current carrying capacity of the conductor connected. This arrangement will avoid danger in the event of a fault by ensuring prompt operation of the protective device at the appropriate current value which will otherwise cause damage to the cable or the current using equipment.
- (b) A fault on one circuit should not result in the shutting down of any unrelated parts of the installation as far as reasonably practicable.

For this, it is recommended that—

- (i) fixed lighting fittings of an installation should be arranged to be fed by two or more final circuits;
 - (ii) lighting final circuits should be electrically separated from power circuits except that it may be connected to bell transformers or electric clocks;
 - (iii) power circuits for kitchens should be electrically separated from other power circuits.
- (c) Where the supply is designed to be taken from more than one transformer, interconnection facilities between the main incoming circuit breakers should be provided if requested by the electricity supplier. All incoming and interconnection circuit breakers should be of 4-pole type interrupting all live conductors (i.e. phase and neutral conductors) and electrically and mechanically interlocked to prevent the electricity supplier's transformers from operating in parallel.

(Note: Castell key interlock is one of the acceptable means of mechanical interlock. When an installation utilizes more than one set of castell key interlocks, each set of keys should be different from others so that the key can only be inserted to the switchgear intended to be controlled. No redundant castell keys should be readily available.)

(2) *Control*

Each circuit should be provided with means of interrupting the supply on load and isolation for electrical servicing and testing purposes without affecting other circuits.

(3) *Identification*

(a) Protective devices of each circuit should be clearly labelled or identified so that the rating of the devices and the circuits they protect can be easily recognised.

(b) Every socket in a three phase installation should be marked with the appropriate phase identification (e.g. L1, L2 and L3 etc.) in a permanent manner.

(4) *Electrical separation for essential circuits*

Final circuits for emergency lighting, fire fighting equipment and fireman's lift should be electrically separated from one another and from other circuits.

(5) *Load distribution*

Single phase loads in an installation with a three phase supply should be evenly and reasonably distributed among the phases.

(6) *Arrangement of neutral conductor*

(a) Neutral conductor of a single phase circuit should not be shared with any other circuit.

(b) Neutral conductor of a three phase circuit should only be shared with its related phases in a three phase four wire system.

(c) For a polyphase circuit, the neutral conductor should have at least the full size of current carrying live conductors to cater for any imbalance or harmonic currents which may occur in normal services. For balanced three-phase systems where the total harmonic distortion due to third harmonic current or multiples of the third harmonic is greater than 15% of the fundamental line current, the rating factors given in Appendix 11 of BS 7671 should be taken into account.

6C **Ring Final Circuit Arrangement**

(a) The circuit conductor of a ring circuit should be run in the form of a ring, commencing from the origin of the circuit in the distribution board, looping into the terminal of socket outlets connected in the ring, and returning to the same point of the circuit as illustrated in Figure 6(1).

- (b) The circuit protective conductor of a ring circuit (other than formed by the metal coverage or enclosure containing all conductors of the ring circuit) should also be run in the form of a ring having both ends connected to the earthing terminal at the origin of the circuit.
- (c) When two or more ring final circuits are installed, socket outlets and equipment to be served by these circuits should be evenly and reasonably distributed among these separate ring final circuits.

6D Final Circuits Using 5A or 15A Socket Outlets to Requirements Prescribed in Appendix 1

- (a) Radial final circuits should be used.
- (b) Each 5A and 15A socket outlet should be individually connected and protected by a high breaking capacity (HBC) fuse or miniature circuit breaker (MCB) of rating 5A and 15A respectively.

6E Final Circuits Using 13A Socket Outlets to Requirements Prescribed in Appendix 2

(1) *General*

- (a) Ring or radial final circuits should be used.
- (b) The circuit, with spurs if any, may feed permanently connected equipment and an unlimited number of socket outlets in a limited floor area determined by Table 6(1). A typical circuit is illustrated in Figure 6(2).

(2) *Spurs*

- (a) For a final circuit in compliance with Table 6(1), the number of fused spurs connected is unlimited but the number of non-fused spurs should not exceed the total number of socket outlets and fixed equipment permanently connected in the circuit.
- (b) A non-fused spur should feed only one single or one twin socket outlet or one permanently connected equipment. Such a spur should be connected to a circuit at the terminals of socket outlets or at joint boxes or at the origin of the circuit in the distribution board.
- (c) A fused spur should be connected to the circuit through a fused connection unit, with the rating of the fuse not exceeding that of the cable forming the spur, and not exceeding 13A in any event.

(3) *Separate circuits*

Separate circuits are to be used for:

- (a) socket outlets and fixed appliances in kitchens;
- (b) electric water heaters;
- (c) permanently connected space heaters; and
- (d) air-conditioning units.

(4) *Permanently connected equipment*

Equipment, except shaver supply unit complying with BSEN 61558-2-5 or equivalent, connected permanently (i.e. not through a plug-socket arrangement) to a final circuit arranged in accordance with Table 6(1) should be locally protected by a fuse of rating not exceeding 13A and should be controlled by a switch in a readily accessible position or protected by a miniature circuit breaker of rating not exceeding 16A. This is illustrated in Figure 6(3).

6F **Final Circuits Using 5A, 15A or 30A Industrial Socket Outlets to Requirements Prescribed in Appendix 3**

(1) *Socket outlets*

These are protected type non-reversible socket outlets. Socket outlet without a key and a keyway is for use with non-fused plug and an exclusive radial final circuit must be used for the socket outlet. Socket outlet with a key and a keyway is for use with fused plug.

(2) *Accepted practice*

- (a) Either radial or ring final circuits may be used.
- (b) The current demand of the equipment fed by the circuit will depend on the type of equipment and the operational requirements, and should not exceed the rating of the overcurrent protective device. In assessing the current demand, no diversity is allowed for permanently connected equipment.
- (c) The overcurrent protective device should have a rating not exceeding 32A.
- (d) The number of socket outlets can be unlimited.
- (e) The total current demand of socket outlets served by a fused spur should not exceed 16A.
- (f) A fused spur should be connected to a circuit through a fused connection unit with the rating of the fuse in the unit not exceeding that of the cable forming the spur and, in any event, not exceeding 16A.
- (g) Non-fused spurs should not be used.
- (h) Equipment permanently connected to a circuit should be locally protected and controlled by a fuse of rating not exceeding 16A together with a switch, or by a miniature circuit breaker of rating not exceeding 16A.
- (i) Figure 6(4) illustrates such a circuit arrangement.

6G Final Circuits Using 16A Industrial Socket Outlets to Requirements Prescribed in Appendix 4

(1) *Socket outlets*

These are industrial socket outlets with retaining devices for either indoor or outdoor applications and are for single-phase or three-phase supplies.

(2) *Accepted practice*

- (a) Only radial final circuits should be used.
- (b) Fused or non-fused spur is not allowed.
- (c) The current demand of the equipment fed by the circuit will depend on the type of equipment and the operational requirements, and should not exceed the rating of the overcurrent protective device.
- (d) The overcurrent protective device should have a rating not exceeding 20A.
- (e) The number of socket outlets can be unlimited.
- (f) Figure 6(5) illustrates such a circuit arrangement.

6H Final Circuits Using 32A, 63A or 125A Industrial Socket Outlets to Requirements Prescribed in Appendix 4

(1) *Socket outlets*

These are industrial socket outlets with retaining devices for either indoor or outdoor applications and are for single phase or three phase supplies.

(2) *Accepted practice*

- (a) Only exclusive radial final circuits should be used.
- (b) The number of socket outlets in a final circuit should not be more than one.
- (c) The overcurrent protective device should have a rating not exceeding the rating of the socket outlet or that of the cable forming the circuit.

6I Protection Requirement of High Voltage Circuit

The setting of the protective device for high voltage installation should be in accordance with the manufacturer's data and well designed so that the fault clearance time is within the equipment rating.

Table 6(1)

*Final Circuits Using 13A Socket Outlets
Complying to Requirements Prescribed in Appendix 2*

Type of Circuit	Rating of Overcurrent Protective Device (HBC fuse or Miniature Circuit Breaker)	Min. Copper Conductor Size of Rubber or PVC Insulated Cable for the Circuit and Non-fused Spur (Note)	Maximum Floor Area Served
	(Ampere)	(mm ²)	(m ²)
A1 Ring	30 or 32	2.5	100
A2 Radial	30 or 32	4	50
A3 Radial	20	2.5	20

- Note:*
1. If cables of two or more circuits are bunched together or the ambient air temperature exceeds 30°C the size of conductor should be increased and appropriate correction factors (see Appendix 5) should be applied such that the conductor size should correspond to a current carrying capacity not less than:
 - (i) 20A for A1 or A3 circuits
 - (ii) 30A or 32A for A2 circuits
 2. The conductor size of a fused spur should be determined from the total current demand served by that spur, which is limited to a maximum of 13A. When such spur serves socket outlets, the minimum conductor size is 1.5 mm² for rubber or PVC insulated cables, copper conductors.

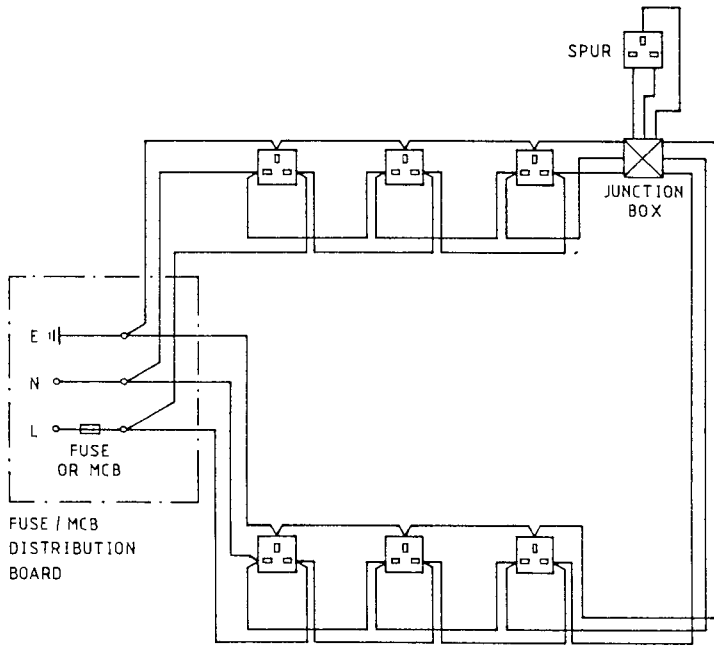

ARRANGEMENT OF CIRCUIT CONDUCTORS OF A RING CIRCUIT

CODE No. 6

FIGURE No. 6(1)

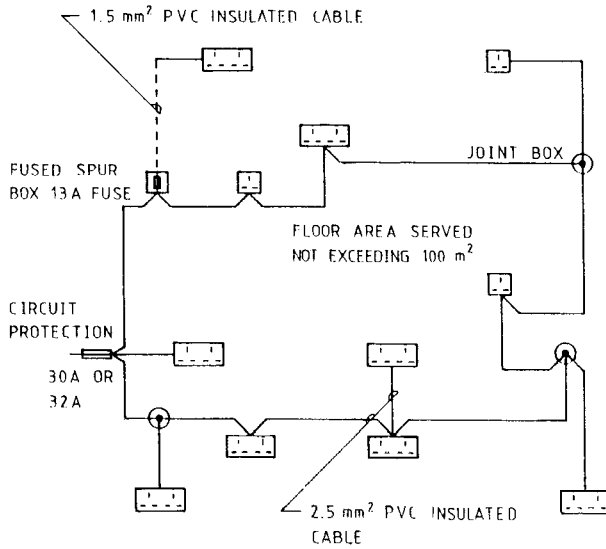

TYPICAL FINAL CIRCUIT USING 13 AMPERE SOCKET OUTLETS

CODE No. 6

FIGURE No. 6(2)

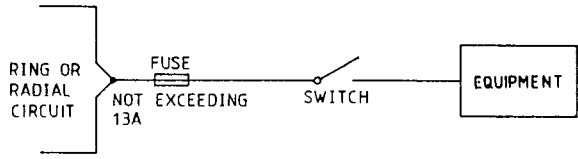

(A) FUSE PROTECTION



(B) CIRCUIT BREAKER PROTECTION

PERMANENTLY CONNECTED EQUIPMENT IN A
FINAL CIRCUIT USING 13 AMPERE SOCKET OUTLETS

CODE No.	6	FIGURE No.	6(3)
----------	---	------------	------

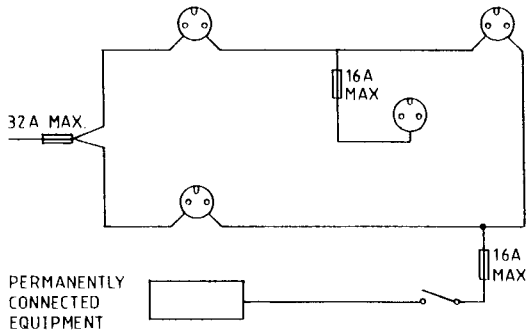

(A) RING CIRCUIT

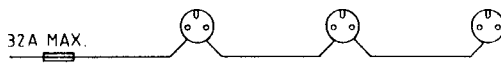

(B) RADIAL CIRCUIT

CIRCUIT ARRANGEMENT FOR FINAL CIRCUITS USING
5 AMPERE, 15 AMPERE OR 30 AMPERE INDUSTRIAL SOCKET OUTLETS

CODE No.

6

FIGURE No.

6(4)

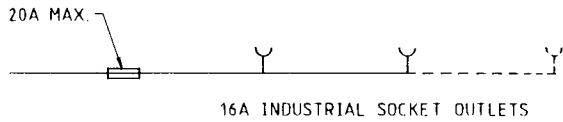

CIRCUIT ARRANGEMENT FOR FINAL CIRCUITS
USING 16 AMPERE INDUSTRIAL SOCKET OUTLETS

CODE No. 6

FIGURE No. 6(5)

Code 7 CURRENT DEMAND

7A Current Demand of a Circuit

7B Determination of Current Demand

- (1) General
- (2) For circuit supplying non-simultaneous or cyclic loads
- (3) For final circuits
- (4) For circuits supplying a number of final circuits

Code 7 CURRENT DEMAND

7A Current Demand of a Circuit

The current rating of a circuit should not be less than the current demand of the circuit.

7B Determination of Current Demand

(1) General

The information and values given in this CoP for determination of current demand are intended for general guidance only as it is impossible to specify the appropriate allowances for diversity for every type of electrical installations.

(2) For circuit supplying non-simultaneous or cyclic loads

For a circuit having non-simultaneous or cyclic loads such that only one of these loads can be in use at any one time, the greatest of these loads should be used in calculating the current demand of the circuit.

(3) For final circuits

To determine the current demand of a final circuit, the following methods should be used:

- (a)* For standard final circuits designed in accordance with Code 6, the current demand of the circuit concerned should be the same as the rating of the overcurrent protective device of the circuit.
- (b)* The current demand of a final circuit other than subparagraph *(a)* should be assessed by summing the assumed current demands of current using equipment connected or intended to be connected as follows:
 - (i)* each socket outlet in a radial final circuit should be assumed to demand its rated current rating;
 - (ii)* lighting outlets should be assumed to demand the connected load with a minimum of 100W per lampholder;
 - (iii)* electric clock, shaver socket outlet, bell transformer, and current using equipment of a rating not greater than 5 VA may be neglected;
 - (iv)* discharge lighting should be assumed to have a demand in volt-amperes of the rated lamp wattage multiplied by not less than 1.8. This multiplier is based upon the assumption that the circuit is corrected to a power factor of not less than 0.85 lagging, and takes into account control gear losses and harmonic currents; and
 - (v)* all other fixed equipment should be assumed to demand the rated or normal current.

(4) *For circuits supplying a number of final circuits*

The current demand of a circuit supplying a number of final circuits may be determined by applying the allowances for diversity given in Table 7(1) to the total current demand of all the equipment connected to the circuit and not by summing the current demands of the individual final circuits obtained according to paragraph (3).

While using Table 7(1), the following points should be noted:

- (a) Table 7(1) applies only to low voltage installations having a current demand not exceeding 400A in each phase.
- (b) For installations having a current demand exceeding 400A per phase, the allowances for diversity should be assessed by a grade B or grade C registered electrical worker as appropriate.
- (c) In Table 7(1) the allowances are expressed either as a percentage of the current demand or, where followed by the letters f.l., as a percentage of the rated full load current of the current using equipment.
- (d) Table 7(1) does not apply to installations in factories and industrial undertakings. Allowances for diversity of such installations will depend on the type of plant and machinery and their operational requirements.

Table 7(1)

Allowance for Diversity

This table is applicable to installations having a current demand not exceeding 400 A in each phase.

Purpose of Conductors or Switchgear to which Diversity Applies	Type of Premises		
	Individual Household Installations, Individual Dwellings of a Block	Small shops, Stores, Offices and Business Premises	Small Hotels, Boarding Houses, Guest Houses, etc.
1. Lighting	66% of total current demand	90% of total current demand	75% of total current demand
2. Heating and Power (Also see 3 to 10 below)	100% of total current demand up to 10 amperes+50% of any current demand in excess of 10 amperes	100% f.l. of largest appliance+75% f.l. of remaining appliances	100% f.l. of largest appliance+80% f.l. of 2nd largest appliance+60% f.l. of remaining appliances
3. Cooking Appliances	10 amperes+30% f.l. of connected cooking appliances in excess of 10 amperes+5 amperes if socket outlet incorporated in unit	100% f.l. of largest appliance+80% f.l. of 2nd largest appliance+60% f.l. of remaining appliances	100% f.l. of largest appliance+80% f.l. of 2nd largest appliance+60% f.l. of remaining appliances

Purpose of Conductors or Switchgear to which Diversity Applies	Type of Premises		
	Individual Household Installations, Individual Dwellings of a Block	Small shops, Stores, Offices and Business Premises	Small Hotels, Boarding Houses, Guest Houses, etc.
4. Motors (other than lift motors, see 8)	—	100% f.l. of largest motor+80% f.l. of 2nd largest motor+ 60% f.l. of remaining motors	100% f.l. of largest motor+50% f.l. of remaining motors
5. Water-Heaters (instantaneous type)	100% f.l. of largest appliance+100% f.l. of 2nd largest appliance+25% f.l. of remaining appliances	100% f.l. of largest appliance+100% f.l. of 2nd largest appliance+25% f.l. of remaining appliances	100% f.l. of largest appliance+100% f.l. of 2nd largest appliance+25% f.l. of remaining appliances
6. Water Heaters (thermostatically controlled)	No diversity allowable Note: It is important to ensure that the distribution board is of sufficient rating to take the total load connected to it without the application of any diversity.		
7. Thermal Storage Space Heating Installations			
8. Lift motors	Note: Subject to requirements specified by the lift engineer registered under Cap. 618, Lifts & Escalators Ordinance.		
9. Water Pumps	100% f.l. of the largest pump motor and 25% of the remaining motors		
10. Air conditioners	100% f.l. of the largest air-conditioner in the premises and 40% f.l. of the remaining air-conditioner(s)	100% of current demand of largest point of utilisation+ 75% of current demand of every other point of utilisation	100% of current demand of largest point of utilisation+ 75% of current demand of every other point of utilisation
11. Arrangements of Final Circuits in accordance with code 6D	100% of current demand of largest circuit+30% of current demand of every other circuit	100% of current demand of largest circuit+ 40% of current demand of every other circuit	
12. Arrangements of Final Circuits in accordance with code 6E	100% of current demand of largest circuit+40% of current demand of every other circuit	100% of current demand of largest circuit+ 50% of current demand of every other circuit	
13. Fixed Equipment of the same type e.g. Refrigerators and freezers other than those listed above	100% of current demand of largest point of utilisation+ 40% of current demand of every other point of utilisation	100% of current demand of largest point of utilisation+ 75% of current demand of every other point of utilisation	100% of current demand of largest point of utilisation+ 75% of current demand of every point in main rooms (dining rooms, etc.) + 40% of every other point of utilisation

Code 8 ISOLATION AND SWITCHING

8A Provision of Isolation and Switching

- (1) General installation
- (2) Appliance, equipment or luminaire
- (3) Unguarded moving parts
- (4) Electric motors
- (5) Switching off for mechanical maintenance
- (6) Emergency switching
- (7) 11kV and 22kV Main Switch

8B Requirements of Isolation and Switching Devices

- (1) General
- (2) Isolating devices
- (3) Devices for switching off for mechanical maintenance
- (4) Devices for emergency switching

Code 8 ISOLATION AND SWITCHING

8A Provision of Isolation and Switching

(1) General installation

- (a) An installation must be provided with a main switch or circuit breaker and a means of isolation to cut off all voltages. These two functions may be incorporated in a single device. The main switch or circuit breaker should interrupt all live conductors (i.e. phase and neutral conductors) and be capable of cutting off the full load current of the installation from supply. For a 3-phase 4-wire a.c. supply, a linked switch or linked circuit breaker may be arranged to disconnect the phase conductors only and in such case, a link should be inserted in the neutral conductor and securely fixed by bolts or screws. The work on 3-phase 4-wire a.c. system with neutral conductor not disconnected from the supply is regarded as live work. Thus, the conditions and safety precautions as stated in Appendix 15 should be followed.
- (b) For an installation serving more than one building, the installation inside separate buildings should be treated as a separate installation, and a separate main switch or circuit breaker and a separate means of isolation for each building are required as in subparagraph (a).
- (c) Every circuit or group of circuits must be provided with:
 - (i) a means of isolation; and
 - (ii) a means of interrupting the supply on load.
- (d) Where a standby generator is installed, electrically and mechanically interlocked 4-pole changeover devices should be used for interconnection between the normal and standby sources to ensure that any neutral unbalance and fault current return to the correct source of supply.
- (e) Under no circumstances must a means of isolation or a switching device be provided in a protective conductor.
- (f) A circuit breaker used to receive supply direct from the electricity supplier's transformer should normally be of draw-out type. An isolator may be used in conjunction with a fixed type circuit breaker provided that it is mechanically interlocked with the circuit breaker.

(2) Appliance, equipment or luminaire

- (a) An appliance, equipment or luminaire, other than that connected by means of a plug and socket outlet should be provided with a means of interrupting the supply on load.

- (b) For electric discharge lighting installation operating normally at an open-circuit voltage exceeding low voltage, an effective local means for isolation of the circuit from supply (such means being additional to the switch normally used for controlling the circuit) should be provided for the isolation of every self-contained luminaire, or of every circuit supplying luminaires at a voltage exceeding low voltage.

(3) *Unguarded moving parts*

An installation where it is necessary for a person or persons to enter or work in close proximity with normally unguarded moving parts which may constitute a hazard should be provided with a means of isolation near the moving parts in addition to any emergency switching provided.

(4) *Electric motors*

Electric motors except exhaust fans having rated power not exceeding 50W and servo-motors should be provided with:

- (a) means of isolation suitably placed and so connected that all voltages may thereby be cut off from the motor and all apparatus including any automatic circuit breaker used therewith. If this means of isolation is remote from a motor, an additional means of isolation adjacent to the motor should be installed or alternatively provision should be made so that the means of isolation can be secured against inadvertent operation as required by Code 8B(2)(g);
- (b) means for starting and stopping, suitably placed for ready operation; and
- (c) means to prevent automatic restarting after a stoppage due to drop in voltage or failure of supply, where unexpected restarting of the motor might cause danger. Such means is not required where the failure of the motor to start after a brief interruption of the supply would be likely to cause greater danger, e.g. motors driving a ventilation fan of a fire protection system. This requirement does not preclude any arrangement for starting a motor at intervals by an automatic control device, where other adequate precautions are taken against danger from unexpected restarting, e.g. various sequential drives in an automatic processing plant, use of safety equipment such as guards, barriers, etc.

(5) *Switching off for mechanical maintenance*

- (a) Means of switching off for mechanical maintenance must be provided where mechanical maintenance may involve a risk of burns or a risk of injury from mechanical movement. These include every circuit supplying:

- (i) an electric motor;
 - (ii) electrical heating equipment;
 - (iii) electromagnetic equipment which may cause mechanical accidents;
 - (iv) luminaires (lamp replacement and cleaning are included as mechanical maintenance); and
 - (v) any other electrically energised equipment from which possible mechanical or heat hazards can arise from the use of electrical energy.
- (b) Suitable means should be provided to prevent electrically powered equipment from becoming unintentionally reactivated during mechanical maintenance, unless the means of switching off is continuously under the control of any person performing such maintenance.
- (c) Where electrically powered equipment is within the scope of BS EN 60204, the requirements for switching off for mechanical maintenance of that standard apply.
- (6) *Emergency switching*
- (a) Means should be provided for emergency switching of any part of an installation where it may be necessary to control the supply to remove an unexpected danger.
- (b) Means for emergency switching should be provided for the purpose of cutting off the appropriate supply to the circuit concerned as rapidly as possible in order to obviate or to remove a dangerous condition as soon as it becomes apparent. A typical example where means for emergency switching should be provided is a machine driven by electrical means which may give rise to danger.
- (c) Where electrically powered equipment is within the scope of BS EN 60204, the requirements for emergency switching of that standard apply.
- (7) *11kV and 22kV Main Switch*
- (a) The 11kV main switch, i.e. the circuit breaker, used to receive supply direct from the electricity suppliers' transformer, should be rated for use at 11kV and fault level of 18.4kA rms for 3 seconds. The lightning impulse withstand voltage should not be less than 75kV peak.
- (b) The 22kV main switch, i.e. the circuit breaker, used to receive supply direct from the electricity suppliers' transformer, should be rated for use at 22kV and fault level of 25kA rms for 3 seconds. The lightning impulse withstand voltage should not be less than 125kV peak.

- (c) Its main breaker should not exceed the approved loading agreed by the power companies in overcurrent setting and should normally be of draw-out type and lockable at that position, rated for fault making and breaking, and should have an earthing switch to earth the incoming cable. Fixed type circuit breaker in conjunction with an isolator which is mechanically interlocked with the circuit breaker may be used provided that there is clear indication between the service position and the isolated position and can be lockable at the isolated position.
- (d) Interlock facilities should be provided between the circuit breaker, the earthing switch and the isolator.
- (e) Safety shutter should be provided at the switchgear spouts.
- (f) The earthing switch at the main incomer should be lockable at open and closed position and of fault making type. The earthing switch should only be operated by mechanical means when it is closed to circuit earth position.
- (g) The earthing mechanism of the main switch should be locked while in open position by the electricity supplier to avoid inadvertent closing of supply to earth. The closing of supply to earth should only be conducted with the permission of the electricity supplier.

8B **Requirements of Isolation and Switching Devices**

(1) *General*

Where a common device is used to perform one or more of the following functions:

- (a) means of isolation;
- (b) means of switching off for mechanical maintenance;
- (c) means of emergency switching,

the arrangement and characteristics of the device should satisfy all the requirements of this Code 8 for the various functions concerned.

(2) *Isolating devices*

- (a) An isolating device should be capable of:
 - (i) opening and closing all live conductors (i.e. phase and neutral conductors) of the circuit under no-load condition provided that, for a 3-phase 4-wire a.c. supply, a linked isolator may be arranged to disconnect the phase conductors only and in such case, a link should be inserted in the neutral conductor and securely fixed by bolts or screws;

- (ii) carrying the normal circuit current;
 - (iii) carrying for a specified time abnormal currents which may occur during an overcurrent condition (i.e. overload or short-circuit).
- (b) The position of the contacts or other means of isolation should be either externally visible or clearly and reliably indicated. An indication of the isolated position should occur only when the specified isolation has been obtained in each pole.
- (c) An isolating device should be designed and/or installed so as to prevent unintentional or inadvertent closure.
- (d) The following devices satisfying subparagraphs (a), (b) and (c) are acceptable as means of isolation:
 - (i) isolators (disconnectors),
 - (ii) fuse switches and switch-fuses,
 - (iii) links, including fuse-links and fuse cut-outs,
 - (iv) plugs and socket outlets,
 - (v) cable couplers,
 - (vi) circuit breakers, including miniature circuit breakers (MCB), moulded case circuit breakers (MCCB) and residual current circuit breakers (RCCB).
- (e) Emergency stop push button and semiconductor devices, such as a 'touch control switch' or 'photo-electric switch', must not be used for isolation.
- (f) Where an isolating device for a particular circuit is placed remotely from the equipment to be isolated, provision should be made so that the means of isolation can be secured in the open position. Where this provision takes the form of a lock or removable handle, the key or handle should be non-interchangeable with any other used for a similar purpose within the premises.
- (g) Each device used for isolation should be clearly identified by position or durable marking to indicate the installation or circuit it isolates.

(3) *Devices for switching off for mechanical maintenance*

- (a) A device used for switching off for mechanical maintenance should:
 - (i) require manual operation;
 - (ii) have visible or clearly and reliably indicated open and closed positions of the contacts;
 - (iii) be designed and/or installed in such a way to prevent inadvertent or unintentional switching on;
 - (iv) be capable of cutting off the full load current of the relevant part of the installation; and
 - (v) be readily accessible for operation.

- (b) The following devices satisfying subparagraph (a) are acceptable as means for switching off for mechanical maintenance:
 - (i) switches,
 - (ii) circuit breakers,
 - (iii) control switches operating contactors,
 - (iv) plugs and socket outlets.

(4) *Devices for emergency switching*

- (a) Means for emergency switching should act as directly as possible on the appropriate supply conductors. The arrangement should be such that one single action only will interrupt the appropriate supply.
- (b) Means of interrupting the supply for the purpose of emergency switching should be capable of cutting off the full load current of the relevant part(s) of the installation.
- (c) The means of operation should be capable of latching or being restrained in the 'off' or 'stop' position, unless both the means of operation for emergency switching and for re-energising are under the control of the same person. The release of an emergency switching device should not re-energise the relevant part of the installation.
- (d) Means of operating (handle, push-button, etc.) a device for emergency switching should be:
 - (i) clearly marked;
 - (ii) preferably coloured red; and
 - (iii) installed in a readily accessible position where danger might occur and, where appropriate, at any additional remote position from which that danger can be removed.
- (e) The following devices satisfying subparagraph (d) are acceptable as emergency switches:
 - (i) switch in the main circuit (e.g. fireman's switch for high voltage discharge lighting installation),
 - (ii) push button and the like in a control or auxiliary circuit (e.g. emergency stop for machinery).
- (f) A plug and socket outlet or similar device should not be selected as a device for emergency switching.
- (g) Fireman's emergency switch should:
 - (i) be coloured red and have fixed on or near it a permanent durable nameplate marked with the words '消防員開關掣 FIREMAN'S SWITCH' (the nameplate should have a minimum size of 150 mm by 100 mm and the lettering should be easily

legible from a distance appropriate to the site conditions but in no case less than 13 mm high);

- (ii) have its 'ON' and 'OFF' positions clearly indicated by lettering legible to a person standing on the ground at the intended site, with the 'OFF' position at the top;
- (iii) be provided with a device to prevent the switch being inadvertently returned to the 'ON' position; and
- (iv) be arranged to facilitate operation by a fireman.

Code 9 OVERCURRENT PROTECTIVE DEVICES

9A General Requirements

- (1) Overcurrent protection for circuit
- (2) Examples of overcurrent protective devices
- (3) Requirements of overcurrent protective devices

9B Relation Between Circuit Conductors and Overcurrent Protective Devices

- (1) Overload protective devices
- (2) Fault current protective devices

9C Breaking Capacity of Overcurrent Protective Devices

- (1) Overload protective devices
- (2) Fault current protective devices

9D Position of Overcurrent Protective Devices

- (1) General
- (2) Overload protective devices
- (3) Fault current protective devices

9E Other Requirements of Overcurrent Protective Devices

Code 9 OVERCURRENT PROTECTIVE DEVICES

9A General Requirements

(1) Overcurrent protection for circuit

Every circuit must be protected by one or more devices for automatic interruption of the supply in the event of overcurrent resulting from:

- (a) overload, or
- (b) fault.

(2) Examples of overcurrent protective devices

The following devices are acceptable as protective devices against overcurrent:

- (a) Miniature Circuit Breakers (MCB)
- (b) Moulded Case Circuit Breakers (MCCB)
- (c) High Breaking Capacity (HBC) Fuses
- (d) Semi-enclosed Fuses
- (e) Circuit Breakers incorporating overcurrent release, or in conjunction with fuse.

(3) Requirements of overcurrent protective devices

- (a) Overload protective devices and fault current protective devices should satisfy the requirements of Codes 9B, 9C, 9D and 9E.
- (b) For devices providing protection against both overload current and fault current, they should satisfy both the requirements of overload protective devices and fault current protective devices.
- (c) The characteristics of devices for overload protection should be coordinated so that the energy let-through by the fault current protective device does not exceed that which can be withstood by the overload protective device without damage. For a circuit incorporating a motor starter, this CoP does not preclude the type of co-ordination described in IEC 60947-4-1, in respect of which the advice of the manufacturer of the starter should be sought.
- (d) Miniature Circuit Breakers (MCB) and Moulded Case Circuit Breakers (MCCB) should be equipped with lockable function such that these devices can be locked off and only be able to be unlocked by the use of keys or tools used to lock off these devices. These keys or tools should be kept by the person who locks these devices.

9B **Relation Between Circuit Conductors and Overcurrent Protective Devices**

(1) *Overload protective devices*

- (a) Overload protective devices should be capable of breaking any overload current flowing in the circuit conductors before such a current could cause a temperature rise detrimental to insulation, joints, terminations, or surroundings of the conductors.
- (b) The nominal current or current setting of the devices should not be less than the design current of the circuit.
- (c) The nominal current or current setting of the devices should not exceed the lowest of the current carrying capacities of any of the conductors in the circuit.
- (d) The current causing effective operation of the devices should not exceed 1.45 times the lowest of the current carrying capacities of any of the conductors of the circuit.

(Note: (i) If the device is a fuse to BS88 part 2 or part 6 or BS1361 or a circuit breaker to IEC 60898 or equivalent satisfying requirement (c), it is also considered to have satisfied requirement (d).

(ii) If the device is a semi-enclosed fuse to BS3036, compliance with requirement (d) is afforded if its nominal current does not exceed 0.725 times the current carrying capacity of the lowest rated conductor in the circuit protected.)

- (e) When the same protective device protects conductors in parallel, other than that of ring circuits, the value for 'the lowest of the current carrying capacities' mentioned in subparagraphs (c) and (d) may be taken as the sum of the current carrying capacities of those conductors in parallel provided that those conductors:
 - (i) are of the same construction, material and cross-sectional area, and are approximately the same length, and appropriate phase disposition;
 - (ii) have no branch circuits throughout their length; and
 - (iii) are arranged so as to carry substantially equal currents.

(2) *Fault current protective devices*

- (a) Fault current protective devices should be capable of breaking any fault current in the conductors of each circuit before such current could cause danger due to thermal and mechanical effects produced in conductors and connections.

- (b) The devices should be able to interrupt all currents caused by a fault occurring at any point of the circuit in a time not exceeding that which brings the cable conductors to their limiting final temperature.

(Note: Table 9(1) gives the limiting final temperatures for some common materials.)

9C **Breaking Capacity of Overcurrent Protective Devices**

(1) *Overload protective devices*

Overload protective devices may have a breaking capacity below the value of the prospective fault current at the point where the device is installed provided that such devices are protected against fault current.

(2) *Fault current protective devices*

- (a) Fault current protective devices should have a breaking capacity not less than the prospective fault current at the point where the device is installed except if the following requirement in subparagraph (b) applies.
- (b) The device may be permitted to have a lower breaking capacity provided that another protective device having the necessary breaking capacity is installed on the supply side. The characteristics of the devices should be coordinated so that the energy let-through of these two devices will not cause damage to the load side device and the conductors protected by these devices.
- (c) The breaking capacities of protective devices against fault current should be assessed for all installations. Table 9(2) shows the minimum breaking capacities for general guidance only.

9D **Position of Overcurrent Protective Devices**

(1) *General*

Overcurrent protective devices should be located in places readily accessible for maintenance.

(2) *Overload protective devices*

- (a) Overload protective devices, subject to subparagraph (b), should be placed where a reduction occurs in the value of current carrying capacity of the conductors of the installation.
- (b) The device may be placed at any point along the run of those conductors provided that the part of run between the point where

the value of current carrying capacity is reduced and the position of the protective device has no branch circuits or outlets for the connection of current using equipment.

(3) *Fault current protective devices*

- (a) Fault current protective devices, subject to subparagraph (b) and (c), should be placed where a reduction occurs in the value of current carrying capacity of the conductors of the installation.
- (b) The device may be placed at any point along the run of those conductors provided that between the point where the value of current carrying capacity is reduced and the position of the protective device provided that the conductors are:
 - (i) not exceed 3m in length, and
 - (ii) be erected in such a manner as to reduce the risk of fault, fire or danger to persons to a minimum.
- (c) The device may be placed at a point other than specified in subparagraph (a) provided that the conductors between the device and the point of reduction in current carrying capacity are adequately protected against fault current according to Code 9B(2) by a fault current protective device installed on the supply side of the point of reduction.

9E **Other Requirements of Overcurrent Protective Devices**

- (a) Overcurrent protective devices should be placed in enclosure that are free from easily ignitable materials.
- (b) Every overcurrent protective device should be provided on or adjacent to it an indication of its intended nominal current as appropriate to the circuit it protects.
- (c) Fuses which are likely to be removed or replaced whilst the circuits they protect are energised, should be of a type such that they can be thus removed or replaced without danger.
- (d) Suitable tools for safe withdrawal of fuses at a fuse board should be provided where necessary.
- (e) Where circuit breakers may be operated by persons other than a registered electrical worker, they should be designed or installed so that it is not possible to modify the setting or the calibration of their overcurrent releases without a deliberate act involving either the use of a key or tool. A visible indication of the setting or calibration is recommended.
- (f) Operating handles of circuit breakers should be made accessible without opening any door or cover giving access to live parts.

- (g) All linked circuit breakers for overcurrent protection of equipment run on polyphase supply must be purposely designed by the manufacturer to enable breaking of all related phase conductors simultaneously. Any modified miniature circuit breaker to achieve as a linked circuit breaker is not acceptable.
- (h) When a consumer's main switch or circuit breaker is connected directly to the electricity supplier's distribution transformer, the overcurrent protection should discriminate with the electricity supplier's high voltage protection settings.

Table 9(1)

Limiting Final Temperatures for Common Materials

Conductor material	Insulation material	Assumed initial temperature °C	Limiting final temperature °C
Copper	70°C thermoplastic (general purpose pvc)	70	160/140*
	90°C thermoplastic (pvc)	90	160/140*
	60°C thermosetting (rubber)	60	200
	85°C thermosetting (rubber)	85	220
	90°C thermosetting	90	250
	Impregnated paper	80	160
Copper	Mineral —plastic covered or exposed to touch	70 (sheath)	160
	—bare and neither exposed to touch nor in contact with combustible materials	105 (sheath)	250
Aluminium	70°C thermoplastic (general purpose pvc)	70	160/140*
	90°C thermoplastic (pvc)	90	160/140*
	60°C thermosetting (rubber)	60	200
	85°C thermosetting (rubber)	85	220
	90°C thermosetting	90	250
	Impregnated paper	80	160

* Where two values of limiting final temperature are given the lower value relates to cables having conductors of greater than 300 mm² cross-sectional area.

Table 9(2)*Minimum Breaking Capacities of Overcurrent Protective Devices*

Types of supply to which the protective devices are connected	Current rating of back-up fuses (if provided) to BS 88 or equivalent	Minimum three phase breaking capacities of the protective devices
(i) Supply directly taken from the transformer within the premises in which the installation is situated.	no back-up fuse fitted	40 kA
	not exceeding 160A	4.5 kA (with back-up fuses)
	exceeding 160A but not exceeding 400A	23 kA (with back-up fuses)
(ii) Supply tapped from busbar rising mains (for cable rising mains, the breaking capacities may be smaller in value depending on the design)	not exceeding 160A	4.5 kA (with back-up fuses)
	exceeding 160A but not exceeding 400A	23 kA (with back-up fuses)
	no back-up fuse fitted	not less than the prospective fault current shown in Table 9(3)
(iii) Supply taken from electricity supplier's service box or overhead line	not exceeding 160A	4.5 kA (with back-up fuses)
	exceeding 160A but not exceeding 400A	18 kA (with back-up fuses)

(Note: The single phase breaking capacity should be assessed by registered electrical workers of the appropriate grade)

Table 9(3)

*Approximate Prospective Fault Current at
Tap-off Positions of Busbar Rising Mains Installation in
kA (kilo-Amperes)*

Length of Busbars (metres)	Rating of Rising Mains			
	200–300A	400–500A	600–800A	1000–2500A
	kA	kA	kA	kA
10	24	26	30	33
13	22	25	30	33
16	21	24	30	33
19	20	23	28	33
22	18	22	28	33
25	18	22	28	33
28	17	21	26	30
31	16	20	26	30
34	15	20	26	30
37	15	19	26	30
40	14	18	24	30
43	13	18	24	30
46	13	17	24	30
49	12	17	24	30
52	12	17	24	28
55	11	16	24	28
58	11	16	22	28
61	11	15	22	28
64	10	15	22	28
67	10	15	22	28
70	10	14	22	28
73	9	14	22	28
76	9	14	20	26
79	9	13	20	26
82	9	13	20	26
85	8	13	20	26
88	8	13	20	26
91	8	12	20	26
94	8	12	20	26
97	7	12	20	26

(Note : The information and values given in this Table are intended for general guidance for 220/380V, prospective fault current of 40kA system only as the prospective fault current will vary for different kinds of busbars)

Table 9(4)

Classification of MCB to IEC 60898 according to the instantaneous tripping current

Type	Instantaneously Tripping Current
B	$3 I_n < I \leq 5 I_n$
C	$5 I_n < I \leq 10 I_n$
D	$10 I_n < I \leq 20 I_n$

Note: The information above is extracted from IEC 60898-1 ed.1.2 "Copyright©2003 IEC Geneva, Switzerland.www.iec.ch".

**Code 10 NEUTRAL CONDUCTOR PROTECTIVE
DEVICES, ISOLATORS AND SWITCHES**

10A Linked Circuit Breakers, Linked Isolators and Linked Switches

10B Protection of Neutral Conductor

10C Single-pole Switch in Earthing Conductor

Code 10 NEUTRAL CONDUCTOR PROTECTIVE DEVICES, ISOLATORS AND SWITCHES

10A Linked Circuit Breakers, Linked Isolators and Linked Switches

- (a) Any linked circuit breaker, linked switch or linked isolator with switched neutral should be arranged to have the neutral pole contact open after the phase pole contacts and should close before or at the same time as the phase pole contacts.
- (b) No fuse, circuit breaker, isolator or switch, other than a linked circuit breaker, linked isolator or linked switch, should be inserted in a neutral conductor.

10B Protection of Neutral Conductor

A single pole switch should be inserted in the phase conductor of a single phase circuit only. No fuse, circuit breaker, isolator or switch, other than a linked circuit breaker, linked isolator or linked switch should be inserted in a neutral conductor.

10C Single-pole Switch in Earthing Conductor

Notwithstanding Code 10B, a single-pole switch may be inserted between the earthing connection and the neutral terminals of generators running or likely to be running in parallel if it is recommended by the manufacturer and adequate precautions have been taken to avoid danger.

Code 11 EARTH LEAKAGE AND EARTH FAULT CURRENTS

11A General

11B Basic Requirements

11C Protective Conductors

- (1) Types of protective conductors
- (2) Sizing of protective conductors

11D Earthing of Exposed Conductive Parts

- (1) General
- (2) Types of exposed conductive parts
- (3) Circuit protective conductor (CPC)

11E Equipotential Bonding

11F Supplementary Bonding

11G Main Earthing Terminal

11H Earthing Conductor

11I Earth Fault Loop Impedance (Z_s)

11J Residual Current Device (RCD)

- (1) Use of residual current device
- (2) Requirements for residual current device

11K Earth Electrodes

Code 11 EARTH LEAKAGE AND EARTH FAULT CURRENTS

11A General

This Code describes one of the means for fault protection: earthed equipotential bonding and automatic disconnection of supply. Other relevant methods for fault protection in accordance with IEC 60364, BS 7671 or other relevant international standard practices are also acceptable.

11B Basic Requirements

- (a) The characteristics of the protective devices for automatic disconnection, the earthing arrangements for the installation and the relevant impedances of the circuits concerned should be coordinated so that during an earth fault, the voltages on any exposed conductive parts and between simultaneously accessible exposed and extraneous conductive parts occurring anywhere in the installation should be of such magnitude and duration as not to cause danger. Conventional means of compliance with the above requirements are given in this Code but other equally effective means shall not be excluded.
- (b) Subparagraph (a) is considered to be satisfied if:
 - (i) for circuits supplying socket outlets, the circuits are protected by residual current device having a rated residual current not exceeding 30 mA.
 - (ii) for circuits supplying only fixed equipment within the equipotential zone, the earth fault loop impedance at every point of utilisation is such that disconnection occurs within 0.4 second (*note 1*).
 - (iii) for circuits supplying fixed equipment outside the equipotential zone, the earth fault loop impedance at every point of utilisation is such that disconnection occurs within 0.2 second (*note 2*).
 - (iv) for installation supplied from low voltage overhead line system, the installation are protected against earth leakage by residual current device.
 - (v) for distribution boards supplying circuits for both socket outlets and fixed equipment, the impedance of the protective conductor between the distribution board and the point at which the protective conductor is connected to the main equipotential bonding does not exceed $50 Z_s/U_0$ ohms, where Z_s is the earth fault loop impedance corresponding to a disconnection time of 5 seconds; or alternatively, equipotential bonding provided at the distribution board in accordance with Code 11E is also acceptable.

(Note: 1. For circuits exceeding 32A, Category 3 circuits, circuits supplying essential equipment which are not readily accessible to the general public, or circuits supplying life-support systems, disconnection may occur within 5 seconds.

2. For circuits exceeding 32A, Category 3 circuits, circuits supplying essential equipment which are not readily accessible to the general public, or circuits supplying life-support systems, disconnection may occur within 0.4 second.)

- (c) Protective devices for automatic disconnection should be provided by means of one or more of the following types, as appropriate:
- (i) overcurrent protective devices in compliance with regulation 9;
 - (ii) residual current devices or an equally effective device.

11C **Protective Conductors**

(1) *Types of protective conductors*

- (a) Types of protective conductors, as illustrated in Figure 11(1), include:
- (i) circuit protective conductors (CPC);
 - (ii) main equipotential bonding conductors;
 - (iii) supplementary bonding conductors; and
 - (iv) earthing conductors.
- (b) Protective conductor(s) may be formed by:
- (i) a separate conductor or cable,
 - (ii) the metallic sheath or armour of a cable,
 - (iii) part of the same cable containing the associated live conductors,
 - (iv) rigid steel conduits, trunking or ducting, or
 - (v) the metal enclosure of the wiring system.
- (c) Where the protective conductor is formed by metallic conduits, trunking or ducting, the requirements as stipulated in Code 14 should also be observed as appropriate.
- (d) Flexible or pliable conduit should not be used as a protective conductor.

(2) *Sizing of protective conductors*

- (a) If a protective conductor is not an integral part of a cable, or is not formed by conduit, ducting or trunking, or is not contained in an enclosure formed by a wiring system, the minimum cross-sectional area should not be less than that given in Table 11(1).

- (b) Subject to subparagraph (a) above, the cross-sectional area of a protective conductor, other than an equipotential or supplementary bonding conductor and not forming part of a twin or multicore cable, that are selected in accordance with the appropriate Tables 11(2), 11(3), 11(4), 11(5), 11(6) and 11(7) are considered acceptable. Alternatively, the cross-sectional area of the protective conductor can be calculated using the formula given in regulation 543.1.3 of BS 7671.
- (c) For an earthing conductor, requirements as stipulated in Code 11H also apply.
- (d) Requirements for the cross-sectional areas of equipotential bonding conductors and supplementary bonding conductors are described in Codes 11E and 11F respectively.
- (e) Where metallic enclosures for cables, busbar trunking and switchgear and controlgear assemblies are used as protective conductors, they should have cross-sectional area equivalent to that of copper, not less than that resulting from application of the formula given in regulation 543.1.3 of BS 7671, or in accordance with Table 11(2).

11D **Earthing of Exposed Conductive Parts**

(1) *General*

Unless other effective precautions are taken to prevent danger, such as the use of double insulated equipment or the use of isolating transformer to BSEN 61558 or equivalent, all exposed conductive parts of equipment (other than live parts) should be connected by means of circuit protective conductors (CPC) to the main earthing terminal of the installation and the terminal should be connected to earth electrode(s) via earthing conductor(s).

(2) *Types of exposed conductive parts*

- (a) Exposed conductive parts include:
 - (i) metallic enclosure of current using equipment, other than double insulated equipment;
 - (ii) metallic conduit, trunking and ducting for enclosure of cable(s);
 - (iii) metallic enclosures of current distribution equipment such as switchgear and controlgear assemblies.
- (b) Exposed conductive parts do not include:
 - (i) wall brackets and metal parts connected to overhead line insulators if such parts are not readily accessible;
 - (ii) inaccessible steel reinforcement in steel reinforced concrete poles;

- (iii) small isolated metal parts such as bolts, rivets, nameplates and cable clips which owing to their small dimensions or their disposition cannot be gripped or contacted by a major surface of the human body in excess of 50 mm × 50 mm;
 - (iv) fixing screws for non-metallic accessories provided that there is no appreciable risk of the screws coming into contact with live parts;
 - (v) short lengths of metal conduit for mechanical protection of cables having a non-metallic sheath.
- (3) *Circuit protective conductor (CPC)*
- (a) For every socket outlet, a separate circuit protective conductor of adequate size should be provided connecting the earthing terminal of the socket outlet and the earthing terminal inside the enclosure accommodating the socket outlet if the CPC is formed by the enclosure.
 - (b) For every length of flexible conduit, a separate circuit protective conductor of adequate size should be provided to ensure the earth continuity of the installation between the two ends of the flexible conduit.
 - (c) Adjacent sections of a busbar trunking used as a CPC should be connected by a protective conductor of adequate size e.g. copper tape or link to ensure the earth continuity between the two sections. This requirement may be waived if it is certified by the manufacturer of the busbar trunking that the earth continuity between the adjacent sections of the busbar trunking is ensured by using the connection accessories provided by the manufacturer.
 - (d) The circuit protective conductor of every ring final circuit (other than that formed by the metal covering or enclosure of a cable) should be run in the form of a ring having both ends connected to the earthing terminal at the origin of the circuit.

11E **Equipotential Bonding**

- (a) In each installation, main equipotential bonding conductors should be connected to the main earthing terminal for all extraneous conductive parts to create an equipotential zone; such conductive parts include:
 - (i) main water pipes;
 - (ii) gas installation pipes;
 - (iii) other service pipes and ducting;
 - (iv) risers and ductings of central heating and air-conditioning systems; and
 - (v) exposed metallic parts of structural framework.

(Note: 1. An extraneous conductive part means a conductive part liable to introduce a potential, generally an earth potential, that does not form part of an electrical installation.

2. Connection of a lightning protection system to the main equipotential bonding should be made in accordance with relevant standard as specified in Code 261.)

- (b) In a large installation, where there are a number of equipotential zones, these zones should be bonded together to form one equipotential zone.
- (c) Aluminium or copperclad aluminium conductors should not be used for bonding connections to water pipes likely to be subjected to condensation in normal use.
- (d) Main equipotential bonding conductors should have cross-sectional areas not less than half the cross-sectional area of the earthing conductor of the installation, subject to a minimum of 6 mm² copper equivalent, and need not exceed 25 mm² copper equivalent.
- (e)
 - (i) Main equipotential bonding connections to any gas or water services should be made as near as practicable to the point of entry of those services into the premises; provided that where there is an insulating section or insert at that point, the connection should be made to the metalwork on the consumer's side of that section or insert.
 - (ii) In particular, for gas services, the bonding connection should be made on the consumer's side of the meter (i.e. between the meter outlet union and any branch pipework). This connection is recommended to be made within 600 mm of the gas meter.
- (f) For application of equipotential bonding and earthing in buildings with information technology equipment, reference can be made to BS EN 50310.

11F **Supplementary Bonding**

- (a) Within the zone formed by the main equipotential bonding, local supplementary bonding connections should be made to metal parts, to maintain the equipotential zone, where those parts are:
 - (i) extraneous conductive parts, and
 - (ii) simultaneously accessible with exposed conductive parts or other extraneous conductive parts, and

(Note: a separation of not more than 2 m is generally considered to be simultaneously accessible.)

 - (iii) not electrically connected to the main equipotential bonding by permanent and reliable metal-to-metal joints of negligible impedance.

- (b) Metalwork which may be required to be bonded includes service pipes or substantial parts which are at a distance not exceeding 2 m from exposed conductive parts. Examples are water pipes adjacent to electric heater or window frame supporting a ventilation fan or air-conditioner or adjacent to a socket outlet. To determine whether conductive parts such as metallic bathroom accessories, metallic windows or metallic door handles etc. are extraneous conductive part, a measurement should be carried out to measure the insulation resistance between the conductive part and the main earthing terminal. For a typical single-phase supply system with a nominal supply voltage of 220V, if the measured resistance could be maintained at not less than 45,000 Ohm (Note) even under the worst conditions (e.g. high moisture), the metallic part could be considered as a non-extraneous conductive part.

(Note: This value is approximated based on IEC 60479-1:2005.)

- (c) Aluminium or copperclad aluminium conductors should not be used for bonding connections to water pipes likely to be subjected to condensation in normal use.
- (d) The minimum cross-sectional area of a supplementary bonding conductor should comply with Table 11(1), subject to the following conditions:
- (i) The bonding conductor connecting two exposed conductive parts should have a cross-sectional area not less than that of the smaller protective conductor connected to the exposed conductive parts.
 - (ii) The bonding conductor connecting exposed conductive parts to extraneous conductive parts should have a cross-sectional area not less than half that of the protective conductor connected to the exposed conductive part.
 - (iii) The bonding conductor connecting two extraneous conductive parts, where one of the extraneous part is connected to an exposed conductive part, should have a cross-sectional area not less than half that of the protective conductor connected to the exposed conductive part.

11G **Main Earthing Terminal**

- (a) In every installation, a main earthing terminal or bar should be provided to connect the following conductors to the earthing conductor:
- (i) the circuit protective conductors;
 - (ii) the main bonding conductors; and
 - (iii) functional earthing conductors (if required).
- (b) The size of bonding conductor connecting the consumer's main earthing terminal and the electricity supplier's transformer earth or metallic sheaths of service cable, should not be less than 150 mm² copper equivalent. Provisions should be made for disconnection of the bonding conductor for testing purposes.

- (c) The main earthing terminal should be effectively connected to the earth electrode(s) by the earthing conductor.
- (d) A warning notice bearing the words 'SAFETY EARTH CONNECTION—DO NOT REMOVE' and '安全接地終端——切勿移去' should be displayed in a conspicuous position at or near the main earthing terminal. The warning notice should comply with requirements of Code 17.

11H **Earthing Conductor**

- (a) The size of an earthing conductor should comply with Code 11C(2) and, in addition, where buried underground, should subject to:
 - (i) a minimum of 2.5 mm² copper equivalent if protected against mechanical damage and corrosion;
 - (ii) a minimum of 16 mm² copper equivalent if protected against corrosion but not protected against mechanical damage; and
 - (iii) a minimum of 25 mm² copper equivalent if not protected against corrosion.
- (b) Aluminium and copperclad aluminium conductors should not be used as earthing conductors for final connections to earth electrodes. Copper conductors or other suitable materials with equivalent resistance to corrosion should be used.
- (c)
 - (i) Test terminals should be provided in an accessible position for disconnecting the earthing conductor from the main earthing terminal, or from the earth electrode, to permit testing and measurements of the resistance of the earthing arrangements.
 - (ii) Where the test terminals are located underground, they should be contained within a concrete lined earth pit with a substantial removable cover to ensure readily accessibility for maintenance and inspection.
 - (iii) Disconnection of the earthing conductor from any test terminals should only be possible by means of a tool.
- (d) Any joint and connection made for the earthing conductor should be mechanically strong and electrically sound. The contact at the connection with the earth electrode(s) should be tinned where necessary to maintain reliable electrical continuity.
- (e) A warning notice bearing the words 'SAFETY EARTH CONNECTION—DO NOT REMOVE' and '安全接地終端——切勿移去' should be displayed in a conspicuous position at or near the point of connection of every earthing conductor to an earth electrode. The warning notice should comply with requirements of Code 17.
- (f) In particular, lightning protection conductors connecting to the main earthing terminal should be properly identified.

11I **Earth Fault Loop Impedance (Zs)**

- (a) For the purpose of Code 11B, the maximum permissible earth fault loop impedance:
 - (i) in compliance with Table 11(10) to achieve automatic disconnection within 0.2 second by the protective device in the event of an earth fault are acceptable;
 - (ii) in compliance with Tables 11(8), 11(9) and 11(10) to achieve automatic disconnection within 0.4 second by the protective device in the event of an earth fault are acceptable;
 - (iii) in compliance with Tables 11(10), 11(11), 11(12) and 11(13) to achieve automatic disconnection within 5 seconds by the protective device in the event of an earth fault are acceptable.
- (b) Where a residual current device is used to protect a circuit, the maximum earth fault loop impedance of that circuit should not exceed those given in Table 11(14).

11J **Residual Current Device (RCD)**

- (1) *Use of residual current device*
 - (a) Residual current devices are to be installed whenever the prospective earth fault current in a circuit is insufficient to cause operation of the overcurrent protective devices within the time specified in Code 11B(b).
 - (b) In particular, protection by means of residual current device should be provided:
 - (i) for socket outlet circuit;
 - (ii) for an electrical installation supplied from overhead line system.
- (2) *Requirements for residual current device*
 - (a) Where a residual current device is installed for compliance with Code 11J(1) above, the device should:
 - (i) have the product of the rated operating current (in amperes) and the earth fault loop impedance (in ohms) not exceeding 50 volts (also see Code 11I(b)); and
 - (ii) be capable of disconnecting all the phase conductor(s) of the circuit.
 - (b) Residual current devices for socket outlet circuit, in addition to requirements of subparagraph (a), should have a rated residual operating current not exceeding 30 mA.
 - (c)
 - (i) A residual current device for fault protection may be incorporated as part of a device which also functions as an overcurrent protective device.
 - (ii) Where a residual current device for fault protection is used with, but separately from, overcurrent protective devices, the residual current device should be capable of withstanding,

without damage, the thermal and mechanical stresses of a fault occurring on the load side of the circuit which it protects. Values of prospective fault current in a typical installation are given in Table 9(3).

- (d) Where a residual current device is used, it should:
 - (i) pass type test to IEC 61008 (for RCCB) or IEC 61009 (for RCBO) or equivalent;
 - (ii) be suitable for independent toggle operation;
 - (iii) have its tripping operation not dependent on a separate auxiliary supply; and
 - (iv) have an integral test device on the front of every RCD to enable the automatic tripping operation to be tested by simulation of an earth fault condition.
- (e) When two or more residual current devices are installed in series and where discrimination of their operation is necessary to prevent danger, the characteristics of the devices should be arranged to achieve the intended discrimination. In general, a time delay should be provided in the upstream device, for example, by the use of a "Type S" (or selective) device.

11K **Earth Electrodes**

Requirements for earth electrodes are described in Code 12.

Table 11(1)

Minimum Cross-sectional Area of Separate Protective Conductor

Installation Method	PVC Insulated (mm ²)		Bare (mm ²)	
	Copper	Aluminium	Copper	Aluminium
Surface wiring	2.5 (sheathed) 4.0 (non-sheathed)	16	> 6	16
In Conduits or trunkings	1.0	16	1.0	16

Table 11(2)

(a) *Minimum Cross-sectional Area of Protective Conductor in Relation to the Cross-sectional Area of Associated Phase Conductor*

Cross-sectional Area of Phase Conductor (S)	Minimum Cross-sectional Area of the Corresponding Protective Conductor	
	If the Protective Conductor is of the Same Material as the Phase Conductor	If the Protective Conductor is not the Same Material as the Phase Conductor
mm ²	mm ²	mm ²
S ≤ 16	S	$\frac{k_1 S}{k_2}$
16 < S ≤ 35	16	$\frac{k_1 16}{k_2}$
S > 35	$\frac{S}{2}$	$\frac{k_1 S}{k_2 2}$

Note: For values of k_1 and k_2 , please refer to tables 11(2)(b), (c), (d), (e) and (f).

(b) *Values of k for insulated protective conductor not incorporated in a cable and not bunched with cables, or for separate bare protective conductor in contact with cable covering but not bunched with cables where the assumed initial temperature is 30°C*

Material of conductor	Insulation of protective conductor or cable covering		
	70°C thermoplastic	90°C thermoplastic	90°C thermosetting
Copper	143/133*	143/133*	176
Aluminium	95/88*	95/88*	116
Steel	52	52	64
Assumed initial temperature	30°C	30°C	30°C
Final temperature	160°C/140°C*	160°C/140°C*	250°C

* Above 300mm²

(c) Values of k for protective conductor incorporated in a cable or bunched with cables, where the assumed initial temperature is 70°C or greater

Material of conductor	Insulation material		
	70°C thermoplastic	90°C thermoplastic	90°C thermosetting
Copper	115/103*	100/86*	143
Aluminium	76/68*	66/57*	94
Assumed initial temperature	70°C	90°C	90°C
Final temperature	160°C/140°C*	160°C/140°C*	250°C

* Above 300mm²

(d) Values of k for protective conductor as a sheath or armour of a cable

Material of conductor	Insulation material		
	70°C thermoplastic	90°C thermoplastic	90°C thermosetting
Aluminium	93	85	85
Steel	51	46	46
Lead	26	23	23
Assumed initial temperature	60°C	80°C	80°C
Final temperature	200°C	200°C	200°C

(e) Values of k for steel conduit, ducting and trunking as the protective conductor

Material of protective conductor	Insulation material		
	70°C thermoplastic	90°C thermoplastic	90°C thermosetting
Steel conduit, ducting and trunking	47	44	58
Assumed initial temperature	50°C	60°C	60°C
Final temperature	160°C	160°C	250°C

(f) Values of k for bare conductor where there is no risk of damage to any neighbouring material by the temperatures indicated

Material of conductor	Conditions		
	Visible and in restricted areas	Normal conditions	Fire risk
Copper	228	159	138
Aluminium	125	105	91
Steel	82	58	50
Assumed initial temperature	30°C	30°C	30°C
Final temperature			
Copper conductors	500°C	200°C	150°C
Aluminium conductors	300°C	200°C	150°C
Steel conductors	500°C	200°C	150°C

Table 11(3)

Minimum Cross-sectional Area of Protective Conductor for Circuits Protected by HBC Fuses to BS88 Part 2

Fuse Rating (Amp)		6	10	16	20	32	50	63	80	100	160	200	250	315	400
Minimum cross-sectional area (sq. mm) of protective conductor for 5 sec. (not including within 0.4 sec.) disconnection	Copper	1	1	1	1.5	2.5	4	6	10	10	16	25	25	35	50
	Aluminium	16	16	16	16	16	16	16	16	16	25	35	50	50	70
Minimum cross-sectional area (sq. mm) of protective conductor for 0.4 sec. disconnection	Copper	1	1	1	1	1	2.5								

Note: The table is based on nominal voltage to earth with nominal voltage U_0 at 220V and for reference only. Please refer to the manufacturer's data.

Table 11(4)

Minimum Cross-sectional Area of Protective Conductor for Circuits Protected by HBC Fuses to BS1361

Fuse Rating (Amp)		5	15	20	30	45	60	80	100
Minimum cross-sectional area (sq. mm) of protective conductor for 5 sec. (not including within 0.4 sec.) disconnection	Copper	1	1	1.5	2.5	4	10	10	16
	Aluminium	16	16	16	16	16	16	16	25
Minimum cross-sectional area (sq. mm) of protective conductor for 0.4 sec. disconnection	Copper	1	1	1	1	2.5			

Note: The table is based on nominal voltage to earth with nominal voltage U_0 at 220V and for reference only. Please refer to the manufacturer's data.

Table 11(5)

Minimum Cross-sectional Area of Protective Conductor for Circuits Protected by Miniature Circuit Breaker Type 1 & 2 to BS 3871 or Equivalent

Earth Fault Loop Impedance Z_s (ohm)	Minimum Cross-sectional Area of Protective Conductor (mm ²) for 5 Sec. and 0.4 Sec. Disconnection	
	Copper	Aluminium
$0.2 \leq Z_s$	1	16
$0.13 \leq Z_s < 0.2$	1.5	16
$0.08 \leq Z_s < 0.13$	2.5	16
$0.05 \leq Z_s < 0.08$	4.0	16
$0.03 \leq Z_s < 0.05$	6.0	16
$0.02 \leq Z_s < 0.03$	10	16
$Z_s < 0.02$	16	25

Note: The table is based on nominal voltage to earth with nominal voltage U_0 at 220V and for reference only. Please refer to the manufacturer's data.

Table 11(6)

Minimum Cross-sectional Area of Protective Conductor for Circuit Protected by Miniature Circuit Breaker (MCB) Type 3, Type B & Type C to IEC 60898 or Equivalent

MCB Rating (Amp)		5	10	15	20	30	50	60	80	100
Minimum cross-sectional area (sq. mm) of protective conductor for 5 sec. (not including within 0.4 sec.) disconnection	Copper	1	1.5	2.5	2.5	4	10	10	16	16
	Aluminum	16	16	16	16	16	16	16	16	25
Minimum cross-sectional area (sq. mm) of protective conductor for 0.4 sec. disconnection	(Please refer to Table 11(5))									

Note: The table is based on nominal voltage to earth with nominal voltage U_0 at 220V and for reference only. Please refer to the manufacturer's data.

Table 11(7)

Minimum Cross-sectional Area of Protective Conductor for Circuit Protected by Moulded Case Circuit Breaker (MCCB) to IEC 60947-2 or Equivalent for 5 Sec. Disconnection

MCCB Rating (Amp)		30	50	60	100	150	200	250	300	400
Minimum cross-sectional area (sq. mm) of protective conductor	Copper	6	10	10	10	10	10	10	16	16
	Aluminum	16	16	16	16	16	16	16	25	25

Note: The table is based on nominal voltage to earth with nominal voltage U_0 at 220V and for reference only. Please refer to the manufacturer's data.

Table 11(8)

Maximum Earth Fault Loop Impedance for 0.4 Sec Disconnection when the Circuit is Protected by General Purpose (gG) Fuses and Motor Circuit Application (gM) fuses to BS88-2 Fuse Systems E (bolted) and G (clip-in) with Nominal Voltage U_0 220V

Fuse Rating (Amp)	2	4	6	10	16	20	25	32
Zs (ohm)	33.3	15.7	7.85	4.68	2.44	1.69	1.29	1.00

Note: The table is based on nominal voltage to earth with nominal voltage U_0 at 220V and for reference only. Please refer to the manufacturer's data.

Table 11(9)

Maximum Earth Fault Loop Impedance for 0.4 Sec. Disconnection when the Circuit is Protected by Fuses to BS1361 or Equivalent with Nominal Voltage U_o 220V

Fuse Rating (Amp)	5	15	20	30	45
Z _s (ohm)	10	3.1	1.6	1.1	0.55

Note: The table is based on nominal voltage to earth with nominal voltage U_o at 220V and for reference only. Please refer to the manufacturer's data.

Table 11(10)

Maximum Earth Fault Loop Impedance for 0.2 Sec., 0.4 Sec. and 5 Sec. Disconnection when the Circuit is Protected by Miniature Circuit Breaker (MCB) to IEC 60898 or Equivalent with Nominal Voltage U_o 220V

Rating (Amp)	6	10	16	20	32	40	50	63	80	100
Z _s (ohm) for type B MCB and RCBO	7.33	4.4	2.75	2.2	1.38	1.1	0.88	0.70	0.55	0.44
Z _s (ohm) for type C MCB and RCBO	3.67	2.2	1.38	1.1	0.69	0.55	0.44	0.35	0.28	0.22

Note: The table is based on nominal voltage to earth with nominal voltage U_o at 220V and for reference only. Please refer to the manufacturer's data.

Table 11(11)

Maximum Earth Fault Loop Impedance for 5 Sec Disconnection when the Circuit is Protected by General Purpose (gG) Fuses and Motor Circuit Application (gM) fuses to BS88-2 Fuse Systems E (bolted) and G (clip-in) with Nominal Voltage U_o 220V

Fuse Rating (Amp)	2	4	6	10	16	20	25	32	40	50	63	80	100	125	160	200
Z _s (ohm)	44.0	20.9	12.2	6.87	4.00	2.82	2.20	1.76	1.29	1.00	0.78	0.55	0.42	0.32	0.26	0.18

Note: The table is based on nominal voltage to earth with nominal voltage U_o at 220V and for reference only. Please refer to the manufacturer's data.

Table 11(12)

*Maximum Earth Fault Loop Impedance for 5 Sec. Disconnection
when a Circuit is Protected by House-service Fuse to
BS1361 or equivalent with Nominal Voltage U_o 220V*

Fuse Rating (Amp)	5	15	20	30	45	60	80	100
Z _s (ohm)	15.7	4.8	2.7	1.8	0.92	0.67	0.48	0.35

Note: The table is based on nominal voltage to earth with nominal voltage U_o at 220V and for reference only. Please refer to the manufacturer's data.

Table 11(13)

*Maximum Earth Fault Loop Impedance for 5 Sec. Disconnection
when a Circuit is Protected by a Moulded Case Circuit Breaker (MCCB)
to IEC 60947-2 or Equivalent with Nominal Voltage U_o 220V*

MCCB Rating (Amp)	30	50	60	100	150	200	250	300	400
MCCB Non-adjustable Z _s (ohm)	0.56	0.44	0.42	0.125	0.09	0.07	0.06	0.05	0.04
MCCB Adjustable Z _s (ohm)	Magnetic setting = 'LO'	—	—	—	—	—	0.1	0.08	0.06
	Magnetic setting = 'HI'	—	—	—	—	—	0.05	0.04	0.03

Note: The table is based on nominal voltage to earth with nominal voltage U_o at 220V and for reference only. Please refer to the manufacturer's data.

Table 11(14)

*Maximum Earth Fault Loop Impedance
when a Circuit is Protected by a Residual Current Device*

Rated Residual Operating Current (mA)	5	10	20	30	100	300	500	1000	2000
Z _s (ohm)	10000	5000	2500	1667	500	167	100	50	25

Note: The table is based on nominal voltage to earth with nominal voltage U_o at 220V and for reference only. Please refer to the manufacturer's data.

CODE OF PRACTICE FOR THE ELECTRICITY (WIRING) REGULATIONS

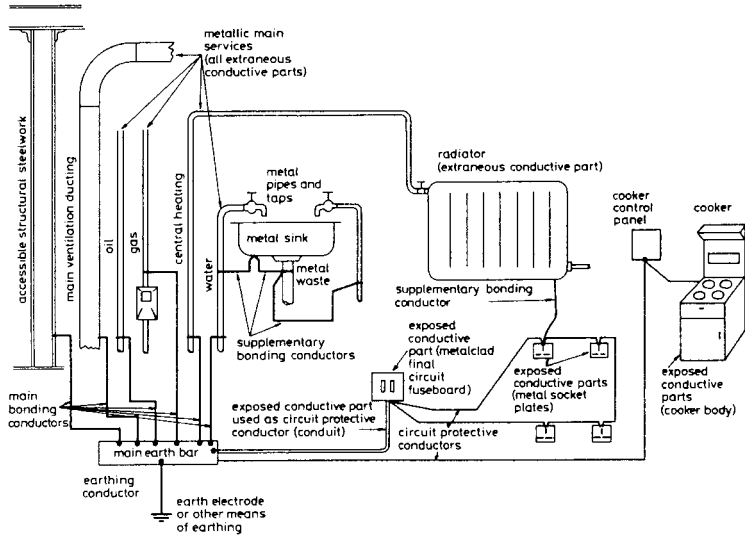

- Note: 1. This figure is not intended to illustrate requirements for bonding and earthing, but merely to identify the functions of particular protective conductors.
2. Earthing for lightning protection installations should be installed in accordance with the relevant international standard.
3. Earthing for H.V. installations should be installed by their separate earthing means.
4. Main bonding conductors shown in the above figure is equivalent to main equipotential bonding conductors.

TYPES OF PROTECTIVE CONDUCTORS

CODE No.	FIGURE No.
11	11(1)

Code 12 EARTHING ARRANGEMENT

12A General

12B Bonding Connections to the Point of Supply

- (1) Supply by transformer
- (2) Supply by underground cable
- (3) To satisfy regulation 11 with bonding disconnected
- (4) Application of Code 12B

12C Earth Electrode

- (1) Types of earth electrodes
- (2) Rod electrode
- (3) Tape electrode
- (4) Plate electrode
- (5) Installation of earth electrodes

Code 12 EARTHING ARRANGEMENT

12A General

- (a) An installation should have an earthing arrangement such that:
 - (i) the installation is protected by its own earth electrode(s); and
 - (ii) the main earthing terminal of the installation is bonded to the earthing facilities that are available from the electricity supplier (as described in Code 12B below).
- (b) For those installations connected to supplies before the commencement of the Wiring Regulations (1 June 1992), they should have one or any combination of the following earthing arrangements:
 - (i) the installation is protected by its own earth electrode(s);
 - (ii) the main earthing terminal of the installation is connected to the earthing facilities provided by the electricity supplier; or
 - (iii) the main earthing terminal of the installation is connected to a common earthing conductor which is connected to earth electrode(s) or the earthing facilities provided by the electricity supplier.

12B Bonding Connections to the Point of Supply

(1) Supply by transformer

Where the supply is taken directly from the electricity supplier's transformer(s) within the premises in which the installation is situated, the main earthing terminal of the installation should be bonded by a conductor or through a common conductor to a bonding terminal provided by the electricity supplier at the point of supply, for example, near the transit block or the main cable terminations on the incoming circuit breakers.

(2) Supply by underground cable

Where the supply is taken from the electricity supplier's underground cable(s) having exposed conductive parts, such as metallic cable endbox, metallic cable glands, cable armour or metallic sheath etc., at the cable termination at the point of supply, the main earthing terminal of the installation should be bonded to these exposed conductive parts via bonding terminal(s) provided by the electricity supplier.

(3) To satisfy regulation 11 with bonding disconnected

Where bonding referred to in subparagraphs (1) and (2) above is used to prevent the rise of a dangerous earth potential, the installation should satisfy all the requirements of regulation 11 of the Wiring Regulations

(Earth leakage and earth fault currents) even if the bonding is disconnected.

(4) *Application of Code 12B*

Code 12B applies only to an installation that is completed or substantially altered on or after the commencement of the Wiring Regulations (1 June 1992).

12C **Earth Electrode**

(1) *Types of earth electrodes*

(a) The material used and the construction of the earth electrodes should be such as to withstand damage due to corrosion. The following types of earth electrodes are acceptable:

- (i) earth rods or pipes;
- (ii) earth tapes or wires;
- (iii) earth plates;
- (iv) metallic reinforcement of concrete, including sheet piles.

(b) the metalwork of gas and water services should not be used as an earth electrode.

(2) *Rod electrode*

(a) The overall diameter of copper rod electrode should not be less than 12.5 mm.

(b) The overall diameter of a rod electrode of materials such as stainless steel and galvanised steel should not be less than 16 mm.

(c) A hardened steel point may be fitted to the penetrating end of the rod electrode.

(d) Additional lengths of rod, whenever required, should each be connected together by a coupling.

(e) For installation of additional rods, it is recommended that a mutual separation of 3.5 m or a distance greater than twice the driven length should be maintained. All rods thus installed should be connected together by means of earthing conductors of adequate size enclosed in PVC ducts and laid at a minimum depth of 600 mm below the ground surface.

(3) *Tape electrode*

(a) Tape electrodes should be copper strip having a cross-section of not less than 25 mm × 3 mm.

(b) In case where several tapes are required for connection in parallel to achieve a low earthing resistance, they may be installed in parallel lines or they may radiate from a point.

(4) *Plate electrode*

Plate electrodes should be of copper not less than 3 mm in thickness and having a maximum dimension of 1 200 mm × 1 200 mm.

(5) *Installation of earth electrode*

Installation of earth electrode should comply with the Electricity Supply Lines (Protection) Regulation as appropriate.

Code 13 CONDUCTORS, JOINTS AND CONNECTIONS

13A Selection and Sizing of Cable Conductors

- (1) General
- (2) Factors to be considered in sizing of cable conductors
- (3) Method of sizing cable conductors
- (4) Typical sizes of cable conductor used in general installations

13B Basic Protection

- (1) Protection by electrical insulation
- (2) Protection by other means

13C Joints and Connections

13D Other Requirements of Cables

- (1) Voltage grading of cables for low voltage application
- (2) Identification of cable cores
- (3) Identification of cables buried direct in ground

Code 13 CONDUCTORS, JOINTS AND CONNECTIONS

13A Selection and Sizing of Cable Conductors

(1) General

A conductor should have a current carrying capacity not less than the maximum current demand it normally carries, be capable of withstanding the prospective fault current, and suitable for operation in the environment and at the design voltage of the installation.

(2) Factors to be considered in sizing of cable conductors

In general, sizing of cable conductors should take into account the following factors:

- (a) the conductor material;
- (b) the insulating material;
- (c) the ambient temperature in which the cable is installed;
- (d) the method of installation;
- (e) whether or not the cable is affected by thermal insulating material;
- (f) the use and type of protective device;
- (g) the voltage drop from the origin of the circuit to the load;
- (h) for Category 4 circuits, the manufacturer's recommendation should be referred; and
- (i) for Category 1 circuits, live conductors should have a cross-sectional area:
 - (i) not less than 1.5 mm² for surface wiring using PVC insulated PVC sheath copper cables;
 - (ii) not less than 1.0 mm² for single core PVC insulated copper cables installed in conduit, duct, ducting or trunking;
 - (iii) not less than 16 mm² for aluminium conductors;
 - (iv) not less than 0.5 mm² for flexible cables and flexible cords.

(3) Method of sizing cable conductors

- (a) In determining the size of cable conductors to be used, the steps employed, in general, are as follows:
 - (i) Determine the design current of the circuit under consideration.
 - (ii) Choose a suitable overcurrent protective device (refer to Code 9).

- (iii) Determine the current carrying capacity of the conductors required by applying suitable correction factors to the nominal setting or current rating of the overcurrent protective device as divisors.

Typical correction factors for ambient temperature, grouping, thermal insulation and type of protective device are given in Appendix 5.

- (iv) Choose suitable size of the conductors according to the current carrying capacity required. Appendix 6 gives the current carrying capacities for various copper conductor sizes of PVC/XLPE insulated cables according to their installation methods. For other types of cables, reference should be made to BS 7671 or IEC 60364.
- (v) The resulting voltage drop in the circuit should be checked so that under normal service conditions the voltage at the terminals of any fixed current using equipment should be greater than the lower limit corresponding to recognised standards relevant to the equipment.

Where the fixed current using equipment concerned is not the subject of a recognised standard, the voltage at the terminals should be such as not to impair the safe function of that equipment.

The above requirements are deemed to be satisfied if the voltage drop between the origin of the installation (usually the supply terminals) and the fixed current using equipment does not exceed 4% of the nominal voltage of the supply.

A greater voltage drop may be accepted for a motor during starting periods and for other equipment with high inrush current provided that voltage variations are within the limits specified in the relevant recognised standards for the equipment or, in the absence of a recognised standard, in accordance with the manufacturer's recommendations.

Table in Appendix 6 also gives the values of voltage drop caused by one ampere for a metre run of PVC/XLPE insulated cables with copper conductors.

If the voltage drop so determined is unsatisfactory, a conductor of larger size should be chosen accordingly.

(4) *Typical sizes of cable conductor used in general installations*

For general installations under the conditions listed below, the sizes of copper conductor in compliance with Table 13(1) are generally acceptable:

- (a) the ambient temperature does not exceed 35°C;
- (b) no more than one circuit of single core cables or one multicore cable are to be grouped together;
- (c) for cables clipped direct on surface, the spacing between groups of single core cables or multicore cables is not less than twice the diameter of the largest cable in the adjacent group of cables;
- (d) the protective device is not a semi-enclosed fuse; and
- (e) the cables are not in contact with any thermal insulation.

13B **Basic Protection**

(1) *Protection by electrical insulation*

- (a) Live conductors should be completely covered with insulation which:
 - (i) is durably withstanding the mechanical, electrical, thermal and chemical stresses to which it may be subjected in service; and
 - (ii) can only be removed by destruction.
- (b) Where insulation is applied during the erection of the installation, the quality of the insulation should be verified by tests equivalent to those specified in recognised standards for similar type-tested equipment.
- (c) Non-impregnated paper, asbestos, fabric, wood or press-hemp should not be used for insulating purposes.
- (d) Where insulating tapes are permitted to be used in low voltage installations, they should have a minimum thickness of 0.21 mm.

(2) *Protection by other means*

Other means of basic protection as stipulated in IEC 60364 or BS7671 are acceptable.

13C **Joints and Connections**

- (a) Every connection at a cable termination or joint should:
 - (i) be mechanically and electrically sound;
 - (ii) be protected against moisture, mechanical damage and any vibration liable to occur;
 - (iii) not impose any appreciable mechanical strain on the fixings of the connection;
 - (iv) not cause any harmful damage to the cable conductor;
 - (v) be appropriate to the size and type of conductors with which they are to be used; and

- (vi) be suitably insulated for the voltage of the circuits in which they are situated.
- (b) No strand of a stranded conductor in a cable core should be cut away in making a cable joint or termination.
- (c) Joints in non-flexible cables should be made by soldering, brazing, welding, or mechanical clamps, or be of the compression type. All mechanical clamps and compression type sockets should securely retain all the wires of the conductor.
- (d) Joints in flexible cable or flexible cord should be made by using appropriate cable couplers.
- (e) Terminations of mineral insulated cables should be made with proper accessories and tools as recommended by the manufacturers.
- (f) Cable glands should securely retain without damaging the outer sheath or the armour of the cables.
- (g) Other details relating to the workmanship of cable joint and termination are described in Code 25D.
- (h) Except for the following, every connection and joint should be accessible for inspection, testing and maintenance:
 - (i) a compound filled or encapsulated joint;
 - (ii) a connection between a cold tail and a heating element (e.g. a ceiling and floor heating system, a pipe trace-heating system); and
 - (iii) a joint made by welding, soldering, brazing or compression tool.

13D **Other Requirements of Cables**

- (1) *Voltage grading of cables for low voltage application*
 - (a) PVC insulated non-sheathed cables to BS EN 50525-2-31 should be 450/750V grade.
 - (b) PVC insulated, PVC sheathed cables up to 35 mm² to BS6004 should be 300/500V grade. For cables greater than 50 mm² to BS6346, voltage grade should be 600/1000V.
 - (c) PVC insulated, PVC sheathed armoured cables of any size to BS6346 should be 600/1000V grade.
 - (d) XLPE insulated, non-sheathed or PVC sheathed cables to BS7211 should be 450/750V grade and to BS 5467 should be 600/1000V grade.
 - (e) XLPE insulated, PVC sheathed armoured cables to BS5467 and BS 6724 should be 600/1000V grade.

(2) *Identification of cable cores*

- (a) Every cable core of a non-flexible cable or bare conductors in a fixed wiring installation should be identifiable at its terminations and preferably throughout its length by appropriate labels, colours or coding. Label and coding identification should be clearly legible and durable and should be in contrast to the colours of the insulations. The application of tapes, sleeves or discs of the appropriate colours at terminations is acceptable. The use of colours and/or coding should be in accordance with Table 13(2).
- (b) Every cable core of a flexible cable or cord:
 - (i) for use in a single phase circuit should have its phase conductor coloured brown and its neutral conductor coloured blue throughout its length;
 - (ii) for use in a polyphase circuit, the phase conductors may be coded L1, L2 and L3; and N for the neutral, if any.
- (c) Every cable protective conductor should be coloured exclusively in green-and-yellow.

(3) *Identification of cables buried direct in ground*

Where cables are buried underground, they should be identified by cable cover tiles or identification tapes for the entire underground cable route. The cable tiles or identification tapes should be marked with words 'Danger-cables'.

Table 13(1)

*Minimum Size of PVC Copper Conductors in sq. mm
under the General Installation Conditions
Listed in Code 13A(4)*

Current Rating (Amp)	1-Phase 2-Wire							3-Phase 4-Wire									
	5	15	20	30	60	80	100	5	15	20	30	60	100	150	200	300	400
Enclosed Condition	1.0	2.5	2.5	4	16	25	35	1.0	2.5	2.5	6	16	35	70	120	240	400
Clipped Direct	1.5	2.5	2.5	4	10	16	25	1.5	2.5	2.5	4	10	25	50	70	150	240

Table 13(2)

*Identification of Non-flexible Cables and
Bare Conductors for Fixed Wiring*

Function	Colour Code		Coding
	Old Colour	New Colour	
Phase of single phase circuit	Red (or Yellow or White or Blue)	Brown	L
Phase 1 of 3-phase circuit	Red	Brown	L1
Phase 2 of 3-phase circuit	Yellow (or White)	Black	L2
Phase 3 of 3-phase circuit	Blue	Grey	L3
Neutral	Black	Blue	N
Protective conductor	Green-and-yellow	Green-and-yellow	—

Code 14 WIRING INSTALLATION ENCLOSURE

14A General Requirements

- (1) Enclosures as protective conductors
- (2) Support of enclosures
- (3) Fire barrier

14B Steel Conduit System

- (1) Construction
- (2) Installation

14C Steel Trunking System

- (1) Construction
- (2) Installation

14D Plastic or PVC Conduit or Trunking

- (1) Construction
- (2) Installation

14E Cable Capacity of Enclosures

- (1) General requirements
- (2) Determination of cable capacities

14F Enclosures of Busbar Trunking System and Powertrack System

14G Workmanship

Code 14 WIRING INSTALLATION ENCLOSURE

14A General Requirements

(1) Enclosures as protective conductors

- (a) Metallic enclosures for cables, busbar trunking and switchgear and controlgear assemblies, where used as protective conductors should:
 - (i) have a cross-sectional area not less than that determined from the application of Code 11C(2)(e) or verified by test in accordance with IEC 60439-1 or equivalent;
 - (ii) have an electrical continuity achieved and maintained to afford protection against mechanical, chemical or electrochemical deterioration; and
 - (iii) permit the connection of other protective conductors at every predetermined tap-off point.
- (b) Where conduit, trunking or ducting are used as a protective conductor, the earthing terminal of each accessory should be connected by a separate protective conductor of adequate size to an earthing terminal incorporated in the associated box or enclosure.

(2) Support of enclosures

All conduit, ducting and trunking installations should be properly supported and of a type suitable for any risk of mechanical damage to which they may be liable in normal conditions of service or adequately protected against such damage.

(3) Fire barrier

- (a) Where conduit, duct, ducting or trunking pass through fire-resistant structural elements such as floors and walls designated as fire barriers, the opening made should be sealed according to the fire resistance requirements of BS 476:Part 20 or equivalent.
- (b) Where cables, conduits or conductors are installed in channel, duct, ducting, trunking or shaft which pass through fire-resistant structural elements, suitable internal fire-resistant barriers should be provided to prevent the spread of fire.

14B Steel Conduit System

(1) Construction

- (a) Steel conduits and fitting with metric thread, except flexible conduits, should be of heavy gauge, longitudinally welded type and comply with BS4568, BS EN 60423, BS EN 61386, IEC 60423, IEC 61386 or equivalent. The nominal minimum outside diameter of any rigid conduit to be used should be 16 mm with a minimum wall thickness of 1.4 mm.

- (b) Flexible steel conduits should comply with BS EN 61386, IEC 61386 or equivalent. In addition, where flexible conduits are exposed to weather or in damp situations, the conduits should be of the metallic type with PVC oversheath.
- (c) All steel conduits, conduit fittings and the associated metallic boxes for the enclosure of electrical accessories should be protected against corrosion on both the inside and outside surfaces.

(2) *Installation*

- (a) The steel conduit installation should be made mechanically and electrically continuous throughout, be effectively earthed and comply with BS4568, BS EN 60423, BS EN 61386, IEC 60423, IEC 61386 or equivalent.
- (b) An adequate number of suitably sized adaptable boxes should be provided in the conduit installation to enable cables to be drawn in easily and without damage.
- (c) Flexible steel conduit should not be used as a protective conductor and it should have a separate circuit protective conductor of adequate size for earth continuity.
- (d) Conduits should be installed so as to prevent accumulation of condensed moisture or water in any part of the installations.

14C **Steel Trunking System**

(1) *Construction*

- (a) Steel trunking and fittings should be fabricated with sheet steel having a minimum thickness as indicated in Table 14(1) and should comply with the requirements specified in BS4678: Part 1 or equivalent.
- (b) Underfloor trunking should be compatible to the requirements laid down in BS4678: Part 2 or equivalent and should be fabricated with sheet steel of:
 - (i) not less than 1.2 mm thickness for compartment width up to and including 100 mm;
 - (ii) not less than 1.6 mm thickness for compartment width over 100 mm; and
 - (iii) not less than 1.0 mm thickness for the partitions and connector material.
- (c) Steel trunking installations should be constructed using manufacturer's standard fittings such as tee or angle pieces, connectors etc., throughout as far as practicable.
- (d) All steel trunking and fittings should be protected against corrosion.

(2) *Installation*

- (a) The steel trunking installation should be made mechanically and electrically continuous throughout, and be effectively earthed.
- (b) Electrical continuity should be achieved by means of connecting a protective conductor (e.g. copper tape) of adequate size across the two adjacent ends of the trunking.
- (c) Every entry to the trunking installation should be so placed as to prevent and/or to be protected against the ingress of water.

14D **Plastic or PVC Conduit or Trunking**

(1) *Construction*

- (a) Rigid plastic or PVC conduits and conduit fittings should be of such strength to withstand the stress under the installed conditions. They should comply with BS4607: Part 1 and 2, BS EN 61386, IEC 61386 or equivalent.
- (b) Pliable conduits should be made of self-extinguishing plastic material and comply with BS4607: Part 3 or equivalent.
- (c) Adaptable boxes and boxes for the enclosure of electrical accessories that are made of insulating materials should comply with BS4662 or equivalent and have a minimum wall thickness of 2 mm.

(2) *Installation*

- (a) Plastic or PVC conduit or trunking systems should only be installed where they are suitable for the extremes of ambient temperature to which they are likely to be subject under the installed conditions. Rigid PVC conduits or trunking should not be used where the normal working temperature of the installation may exceed 60 C.
- (b) Any exposed conductive parts of a PVC or plastic conduit system or trunking should be connected to earth by protective conductor of adequate size for maintaining an effective continuity. Where the plastic or PVC conduit system is made between metal conduit system, the earthing connection should be made at the steel conduit/trunking and at the nearest boxes with proper terminals.
- (c) The method of support and installation for rigid PVC conduits should allow for the longitudinal expansion and contraction of the conduits which may occur with variation of temperature under normal operating conditions.

14E **Cable Capacity of Enclosures**

(1) *General requirements*

The numbers of cables drawn into, or laid in, an enclosure of a wiring installation should be such that no damage is caused to the cables or to the enclosure.

(2) *Determination of cable capacities*

Cable capacities of conduit and trunking enclosing single-core PVC insulated cables (for high voltage cables, the manufacturer's recommendation should be referred) can be determined by the "unit system" method described below:

- (a) Straight runs of conduit not exceeding 3 m in length:
 - (i) For each cable to be used, obtain the appropriate cable factor from Table 14(2)(a).
 - (ii) Add all the cable factors so obtained and compare with the conduit factors given in Table 14(2)(b).
 - (iii) The conduit size is considered satisfactory if the conduit factor is equal to or exceeds the sum of the cable factors.
- (b) Straight runs of conduit exceeding 3 m in length or in runs of any length incorporating bends or sets:
 - (i) For each cable to be used, obtain the appropriate cable factor from Table 14(3)(a).
 - (ii) Add all the cable factors so obtained and compare with the conduit factors given in Table 14(3)(b), taking into account of the length of run and number of bends in that run.
 - (iii) The conduit size is considered satisfactory if the conduit factor is equal to or exceeds the sum of the cable factors.
 - (iv) The term 'bend' signifies a 90° bend and one double set is equivalent to one bend.
- (c) Trunking of any length of run:
 - (i) For each cables to be used, obtain the appropriate cable factor from Table 14(4)(a).
 - (ii) Add all the cable factors so obtain and compare with the trunking factors given in Table 14(4)(b).
 - (iii) The trunking size is considered satisfactory if the trunking factor is equal to or exceeds the sum of the cable factors.
- (d) For sizes and types of cable and sizes of trunking other than those given in Tables 14(4)(a) and 14(4)(b), the number of cables drawn into a trunking should be such that the resulting space factor should not exceed 45%.

(Note: Space factor is defined as the ratio (expressed as a percentage) of the sum of the overall cross-sectional area of cables (including insulation and any sheath) to the internal

cross-sectional area of the trunking in which they are installed. The effective overall cross-sectional area of a non-circular cable is taken as that of a circle of diameter equal to the major axis of the cable.)

14F Enclosures of Busbar Trunking System and Powertrack System

Requirements for the enclosures of busbar trunking system are described in Code 26B. A powertrack system should comply with BS EN 61534 series.

14G Workmanship

- (a) Conduits should not be bent in such a manner which appreciably distorts their original cross-sectional shape or causes damage to the conduits.
- (b) Burrs, sharp edges and projections should be removed from the internal surfaces and ends of conduits, trunking or other enclosures when installed.
- (c) Where the protective coating on a metallic enclosure has been damaged after installation, such surface should be effectively restored by paint or other suitable coating to prevent corrosion.
- (d) Other details relating to the workmanship of installation of conduits and trunking are described in Code 25.

Table 14(1)

Nominal Size (mm × mm)	Minimum Thickness of Body Material (in mm)
50 × 50	1.0
75 × 50	1.2
75 × 75	1.2
100 × 75	1.2
150 × 100	1.4
150 × 150	1.6

Minimum Thickness of Body Material for Metallic Trunking

(Note: Metallic trunkings having nominal size differing from the table but complying with IEC 61084 or equivalent are also acceptable.)

Table 14(2)

*Cable Factors and Conduit Factors for Straight Runs of
Conduit not Exceeding 3 m in Length*

(a) Cable Factor

Type of Conductor	Conductor Cross-Sectional Area (mm ²)	Factor
Solid	1	22
	1.5	27
	2.5	39
Stranded	1.5	31
	2.5	43
	4	58
	6	88
	10	146

(b) Conduit Factor

Conduit Diameter (mm)	Factor
16	290
20	460
25	800
32	1 400

Table 14(3)

Cable Factors and Conduit Factors for Conduit Exceeding 3 m in length or in Runs Incorporating Bends or Sets

(a) Cable Factor

Type of Conductor	Conductor Cross-Sectional Area (mm ²)	Factor
Solid or stranded	1	16
	1.5	22
	2.5	30
	4	43
	6	58
	10	105

(b) Conduit Factor

Length of Run (m)	Conduit Diameter (mm)																							
	16	20	25	32	16	20	25	32	16	20	25	32	16	20	25	32	16	20	25	32				
	Straight				One bend				Two bends				Three bends				Four bends							
1	Covered by Tables 14(2) (a) and (b)				188	303	543	947	177	286	514	900	158	256	463	818	130	213	388	692				
1.5					182	294	528	923	167	270	487	857	143	233	422	750	111	182	333	600				
2					177	286	514	900	158	256	463	818	130	213	388	692	97	159	292	529				
2.5					171	278	500	878	150	244	442	783	120	196	358	643	86	141	260	474				
3					167	270	487	857	143	233	422	750	111	182	333	600								
3.5					179	290	521	911	162	263	475	837	136	222	404	720	103	169	311	563				
4					177	286	514	900	158	256	463	818	130	213	388	692	97	159	292	529				
4.5					174	282	507	889	154	250	452	800	125	204	373	667	91	149	275	500				
5					171	278	500	878	150	244	442	783	120	196	358	643	86	141	260	474				
6					167	270	487	857	143	233	422	750	111	182	333	600								
7					162	263	475	837	136	222	404	720	103	169	311	563								
8					158	256	463	818	130	213	388	692	97	159	292	529								
9					154	250	452	800	125	204	373	667	91	149	275	500								
10					150	244	442	783	120	196	358	643	86	141	260	474								

Table 14(4)*Cable Factors and Trunking Factors for Trunking of any Length of Run*

(a) Cable Factor

Type of Conductor	Conductor Cross-sectional Area (mm ²)	Factor
Solid	1.5	7.1
	2.5	10.2
Stranded	1.5	8.1
	2.5	11.4
	4	15.2
	6	22.9
	10	36.3

(b) Trunking factor

Dimensions of trunking (mm × mm)	Factor
50 × 37.5	767
50 × 50	1 037
75 × 25	738
75 × 37.5	1 146
75 × 50	1 555
75 × 75	2 371
100 × 25	993
100 × 37.5	1 542
100 × 50	2 091
100 × 75	3 189
100 × 100	4 252

Code 15 ADVERSE CONDITIONS INSTALLATION

15A Presence of Water (AD) or High Humidity (AB)*

- (1) Construction of equipment
- (2) Conductors and enclosures of wiring installations
- (3) Switches and socket outlets

15B Ambient Temperature (AA)

- (1) General
- (2) Electrical insulations
- (3) Conductors and cables
- (4) Enclosures of wiring installations
- (5) External heat sources

15C Presence of Corrosive or Polluting Substance (AF)

15D Installation Exposed to Fire or Explosion

- (1) General
- (2) Electrical equipment selection
- (3) Wiring systems

15E Impact (AG)

15F Vibration (AH)

15G Other Mechanical Stresses

* For codes of external influences, table 15(3) refers.

Code 15 ADVERSE CONDITIONS INSTALLATION

15A Presence of Water (AD) or High Humidity (AB)

(1) Construction of equipment

- (a) A wiring system should be selected and erected so that no damage is caused by high humidity, high condensation or ingress of water during installation, use and maintenance.
- (b) Where water may collect or condensation may form in a wiring system, provision should be made for its harmless escape through suitably located drainage points.
- (c) Where a wiring system may be subjected to waves (AD6), protection against mechanical damage should be afforded by one or more of the methods given in Codes 15E, 15F and 15G.

(2) Conductors and enclosures of wiring installations

- (a) Copperclad aluminium conductors should not be used.
- (b) All exposed conductors and insulations at terminations and joints of cables that are insulated with impregnated paper should be suitably sealed against ingress of moisture.
- (c) Every joint in a cable should be suitably insulated and protected against the effect of moisture or water.
- (d) Overall PVC covering should be provided for mineral insulated cable.
- (e) The ends of mineral insulated cables should be suitably sealed with purposely designed terminations and sealing material, having adequate insulating and moisture proofing properties throughout the range of temperatures to which they may be subjected in service. The mineral insulation of the cables should be thoroughly dried before the sealing material is applied.
- (f) Every entry to finished ducts, ducting or trunking should be placed so as to prevent the ingress of water, or be protected against such ingress.
- (g) All metal sheath and armour of cables, metal conduits, ducts, ductings, trunkings, clips and their fixings, should be of corrosion resisting material or finish and should not be placed in direct contact with other dissimilar metals which they are liable to set up electrolytic action.

In particular, contact between bare aluminium sheaths or aluminium conduits and any parts made of brass or other metal having a high copper content should be avoided in damp situation unless the parts are suitably plated.

- (h) In damp situations, enclosures for cores of sheathed cables from which the sheath has been removed and for non-sheathed cables at terminations of conduit, duct, ducting or trunking systems, should be damp proof and corrosion resistant.
- (i) Metallic sheaths, conduits etc. in installations underwater or likely to be underwater should not be relied upon as the only protective conductor and a separate copper protective conductor should be used.

(3) *Switches and socket outlets*

- (a) Switches having watertight enclosures with minimum IP54 or equivalent are acceptable for an installation exposed to weather.
- (b) Socket outlets complying with IEC 60309-2 or equivalent and provided with a push-on cap and cap retaining ring or a screw-on cap with rubber gasket are acceptable for an installation exposed to weather. The socket outlets should also have a degree of protection of at least IPX4 or equivalent.

15B **Ambient Temperature (AA)**

(1) *General*

- (a) A wiring system should be selected and erected so as to be suitable for the highest and lowest local ambient temperature likely to be encountered.
- (b) The components of a wiring system, including cables and wiring enclosures should be installed or handled only at temperatures within the limits stated in the relevant product specification or as recommended by the manufacturer.

(2) *Electrical insulations*

The maximum permissible operating temperature for various classes of insulation complying with IEC 60085 are given in Table 15(1).

(3) *Conductors and cables*

- (a) The type and current carrying capacity of every conductor, cable and flexible cord, termination and joint should be selected so as to be suitable for the highest operating temperature likely to occur in normal service, account being taken of any transfer of heat from any accessory, appliance or luminaire to which the conductor, cable or flexible cord is connected.
- (b) The maximum operating and ambient temperatures, in general, for various types of cable insulations are given in Table 15(2).

- (c) Where cables are to be connected to bare conductors or busbars, it should be verified that their type of insulation and/or sheath is suitable for the maximum operating temperature of the bare conductors or busbars.

(4) *Enclosures of wiring installations*

- (a) The enclosures of wiring installations for conductors and cables should be selected and installed so that they are suitable for the extremes of ambient temperature to which they are likely to be exposed in normal service.
- (b) In every vertical channel, duct, ducting or trunking installations containing conductors or cables, internal barriers should be provided between floors or at intervals of 5 m whichever is the less so as to prevent the air at the top of the channel, duct, ducting or trunking from attaining an excessively high temperature.

(5) *External heat sources*

- (a) To avoid the effects of heat from external sources including solar gain, one or more of the following methods, or an equally effective method, should be used to protect the wiring system:
 - (i) shielding;
 - (ii) placing sufficiently far from the source of heat;
 - (iii) selecting a system with due regard for the additional temperature rise which may occur;
 - (iv) local reinforcement or substitution of insulating material.
- (b) Parts of a cable or flexible cord within an accessory, appliance or luminaire should be suitable for the temperatures likely to be encountered, as determined in accordance with Code 15B(1)(a), or should be provided with additional insulation suitable for those temperatures.

15C Presence of Corrosive or Polluting Substance (AF)

- (a) Where the presence of corrosive or polluting substances is likely to give rise to corrosion or deterioration, parts of the wiring system likely to be affected should be suitably protected or manufactured from materials resistant to such substances.
- (b) Metals liable to initiate electrolytic action should not be placed in contact with each other.
- (c) Suitable precautions against corrosion should be taken for metalwork and metallic parts of wiring systems that are liable to chemical or electrolytic attack by materials of a structure with which they may come in contact. Materials likely to cause such attack include:

- (i) materials containing magnesium chloride which are used in the construction of floors and dadoes;
- (ii) plaster undercoats contaminated with corrosive salts;
- (iii) lime, cement and plaster, for example on unpainted walls;
- (iv) oak and other acidic woods;
- (v) dissimilar metals liable to set up electrolytic action.

Application of suitable coatings before erection, or prevention of contact by separation with plastics, are recognised as a suitable precaution against corrosion.

- (d) Non-metallic materials used in wiring systems should not be placed in contact with materials likely to cause chemical deterioration of the wiring systems. Such materials should either be installed where they will not be exposed to contact with oil, creosote, and similar hydrocarbons, or be of a type designed to withstand such exposure.
- (e) Overall PVC covering should be provided for mineral-insulated cables that are exposed to risk of corrosion.
- (f) In onerous dust conditions, enclosures of the wiring installations should have a degree of protection such that dust cannot enter in sufficient quantity to interfere with operation of the equipment. Enclosures built to IP5X or equivalent are considered acceptable.

15D **Installation Exposed to Fire or Explosion**

(1) *General*

- (a) Electrical equipment and wiring of electrical installations exposed to potentially explosive atmospheres should be constructed and protected to the requirements specified for hazardous areas to IEC 60079 or equivalent.
- (b) Electrical equipment and wiring of electrical installations in buildings and premises for the storage, manufacture or packing of dangerous goods in Categories 1 to 10 must comply with the provisions of Dangerous Goods (General) Regulations (Cap. 295).
- (c) Electrical equipment and wiring of electrical installations in building and premises for Categories 2 and 5 Dangerous Goods including those in building and premises for liquid petroleum gas storage and for petrol filling stations should, in addition to subparagraphs (a) and (b) above, comply with the requirements specified for hazardous areas in the Electrical Safety Code Part 1 and 15 of the Energy Institute/Institute of Petroleum Model Code of Safe Practice for the Petroleum Industry or equivalent.

- (d) Electrical equipment and wiring of electrical installations in mines should comply with the Mining Ordinance and Mines (Safety) Regulations (Cap. 285), and should be constructed and protected to relevant recognised standards.

(2) *Electrical equipment selection*

- (a) Type of protection of electrical equipment for achievement of safety should be in accordance to zone of risk listed in Table 15(4).
- (b) The maximum surface temperature of the T class of an electrical equipment should not exceed the ignition temperature of the gases or vapours involved. Relationship between T class and maximum surface temperature is shown in Table 15(5).
- (c) Electrical equipment with the appropriate apparatus group should be used.

Group I: Electrical apparatus for mines susceptible to firedamp.

Group II: Electrical apparatus for places with a potentially explosive atmosphere, other than mines susceptible to firedamp.

(3) *Wiring systems*

The type of wiring that may be used for installation in hazardous areas, and the requirements for permitted types of cable and their accessories dealing with individual types of protection should comply with the recommendations laid down in IEC 60079 or equivalent. All cables, conduit and their accessories should be manufactured to appropriate recognised standards.

15E Impact (AG)

- (a) A wiring system should be selected and erected so as to minimise mechanical damage.
- (b) In a fixed installation where an impact of medium severity (AG2) or high severity (AG3) can occur, protection should be afforded by:
 - (i) the mechanical characteristics of the wiring system, or
 - (ii) the location selected, or
 - (iii) the provision of additional local or general mechanical protection,or by any combination of the above.
- (c) Except where installed in a conduit or duct which provides equivalent mechanical protection, a cable buried in ground should be of a construction incorporating an armour or metal sheath or both, or be of insulated concentric construction. Such cable should be marked by cable covers or a suitable marking tape or by suitable identification of the

conduit or duct and be buried at a sufficient depth to avoid being damaged by any disturbance of the ground reasonably likely to occur.

- (d) A wiring system buried in a floor should be sufficiently protected to prevent damage caused by the intended use of the floor.
- (e) Where a cable is installed under a floor or above a ceiling it should be run in such a position that it is not liable to be damaged by contact with the floor or the ceiling or their fixings. Cable should incorporate an earthed metallic sheath suitable for use as a protective conductor or should be protected by enclosure in earthed steel conduit securely supported, or by equivalent mechanical protection sufficient to prevent penetration of the cable by nails, screws, and the like.
- (f) Where a cable is to be concealed within a wall or partition, the concealed cable should incorporate an earthed metallic covering which complies with the requirements of this CoP for a protective conductor of the circuit concerned, or should be enclosed in conduit, trunking or ducting satisfying the requirements of this CoP for a protective conductor, or by mechanical protection sufficient to prevent penetration of the cable by nails, screws and the like. In case of a concealed bonding conductor, the conductor should be installed in accordance with the above requirements for a cable, or be installed within 150 mm of the top of the wall or partition or within 150 mm of angle formed by two adjoining walls or partitions in a straight run, either horizontally or vertically to the point or accessory.
- (g) For where PVC concealed conduit system is applied, all conduits installed and concealed inside floor slab, wall or partition for cable wiring shall have concrete, cement or plaster cover of thickness not less than 30 mm (or 25 mm for short PVC concealed conduit of length less than 150 mm that is installed within 150 mm of the top of the wall/partition or within 150 mm of an angle formed by two adjoining walls/partitions) to prevent penetration of the cables inside conduits by nails, screws and the like.

15F **Vibration (AH)**

A wiring system supported by, or fixed to a structure or equipment subject to vibration of medium severity (AH2) or high severity (AH3) should be suitable for the conditions and in particular shall employ cables with fixings and connections suitable for such a situation.

15G **Other Mechanical Stresses**

- (a) A wiring system should be selected and erected so as to minimise during installation, use and maintenance, damage to the sheath and insulation of cables and insulated conductors and their terminations.

- (b) There should be adequate means of access for drawing cables in or out and, if buried in the structure, a conduit or cable ducting system for each circuit should be completely erected before cables are drawn in.
- (c) The radius of every bend in a wiring system should be such that conductors and cables shall not suffer damage.
- (d) Where a conductor or a cable is not continuously supported it should be supported by suitable means at appropriate intervals in such a manner that the conductor or cable does not suffer damage by its own weight.
- (e) Every cable or conductor used as fixed wiring should be supported in such a way that it is not exposed to undue mechanical strain and so that there is no appreciable mechanical strain on the terminations of the conductors, account being taken of mechanical strain imposed by the supported weight of the cable or conductor itself.
- (f) A flexible wiring system should be installed so that excessive tensile and torsional stresses to the conductors and connections are avoided.

Table 15(1)

Maximum Permissible Operating Temperature of Various Classes of Insulation to IEC 60085

Class	Y	A	E	B	F	H	200	220	250
Temperature °C	90	105	120	130	155	180	200	220	250

- Note:*
1. Temperatures over 250°C should be increased by 25°C intervals and classes designated accordingly.
 2. The information above is extracted from IEC 60085 ed.2.0 "Copyright©1984 IEC Geneva, Switzerland.www.iec.ch".

Table 15(2)

Maximum Permissible Operating and Ambient Temperatures of Some Common Cable Insulations

Type of Insulation	Maximum Permissible Conductor Operating Temperature (°C)	Maximum Permissible Ambient Temperature (°C)
60°C rubber	60	55
General purpose PVC	70	65
Impregnated Paper (note 1)	80	75
85°C rubber	85	80
Mineral-insulated (a) 70°C sheath (b) 105°C sheath (note 2)	70 105	65 95
Thermosetting (XLPE) (note 3)	90	85
150°C rubber	150	145
Glass fibre with 185°C varnish	185	175

Notes: (1) Applicable only to cables of 600/1000V voltage grade.

(2) For mineral insulated cables that are sheathed with PVC, the values for general purpose PVC are applicable. Otherwise, the values shown for mineral insulated cables relate only to terminations; elsewhere the temperature of the cable should not exceed 250°C.

(3) XLPE means cross-linked polyethylene.

Table 15(3)*Concise List of External Influences*

AA Temperature (°C)		AG Impact		AN Solar radiation
AA1	– 60°C + 5°C	AG1	Low severity	AN1 Low
AA2	– 40°C + 5°C	AG2	Medium severity	AN2 Medium
AA3	– 25°C + 5°C	AG3	High severity	AN3 High
AA4	– 5°C + 40°C			
AA5	+ 5°C + 40°C	AH Vibration		AP Seismic effects
AA6	+ 5°C + 60°C	AH1	Low severity	AP1 Negligible
AA7	– 25°C + 55°C	AH2	Medium severity	AP2 Low severity
AA8	– 50°C + 40°C	AH3	High severity	AP3 Medium severity
				AP4 High severity
AB Temperature and humidity		AK Flora		AQ Lightning
AB1	– 60°C + 5°C 3% 100%	AK1	No hazard	AQ1 Negligible
AB2	– 40°C + 5°C 10% 100%	AK2	Hazard	AQ2 Indirect exposure
AB3	– 25°C + 5°C 10% 100%			AQ3 Direct exposure
AB4	– 5°C + 40°C 5% 95%	AL Fauna		
AB5	+ 5°C + 40°C 5% 85%	AL1	No hazard	
AB6	+ 5°C + 60°C 10% 100%	AL2	Hazard	
AB7	– 25°C + 55°C 10% 100%			AR Movement of air
AB8	– 50°C + 40°C 15% 100%			AR1 Low
		AM Electromagnetic, electrostatic, or ionizing influences		AR2 Medium
AC Altitude (metres)				AR3 High
AC1	≤2,000 metres	AM1	Harmonics, interharmonics	
AC2	>2,000 metres	AM2	Signalling voltages	AS Wind
		AM3	Voltage amplitude variations	AS1 Low
AD Water		AM4	Voltage unbalance	AS2 Medium
AD1	Negligible	AM5	Power frequency variations	AS3 High
AD2	Drops	AM6	Induced low-frequency voltages	
AD3	Spray	AM7	Direct current in a.c. voltages	
AD4	Splashes	AM8	Radiated magnetic field	
AD5	Jets	AM9	Electric fields	
AD6	Waves	AM21	Induced oscillatory voltages or currents	
AD7	Immersion	AM22	Conducted unidirectional transients of the nanosecond time scale	
AD8	Submersion	AM23	Conducted unidirectional transients of the microsecond to the millisecond time scale	
		AM24	Conducted oscillatory transients	
AE Foreign bodies		AM25	Radiated high frequency phenomena	
AE1	Negligible	AM31	Electrostatic discharges	
AE2	Small	AM41	Ionization	
AE3	Very small			
AE4	Light dust			
AE5	Moderate dust			
AE6	Heavy dust			
AF Corrosion				
AF1	Negligible			
AF2	Atmospheric			
AF3	Intermittent			
AF4	Continuous			

(Note: The information above is extracted from IEC 60364-5-51 ed.5.0 "Copyright©2005 IEC Geneva, Switzerland.www.iec.ch".)

Table 15(4)*Selection of Electrical Equipment and Systems according to Zone of Risk*

Type of Protection	Zone in which the protection may be used
'ia' intrinsically-safe apparatus or system 's' special protection (specifically certified for use in Zone 0)	0, 1, 2
'd' flammable enclosure 'ib' intrinsically-safe apparatus or system 'p' pressurization, continuous dilution and pressurized rooms 'e' increased safety 's' special protection 'm' encapsulation	1, 2
'N' type of protection N 'o' oil-immersion 'q' sand filling	2

NOTES:

- Zone 0 Zone in which an explosive atmosphere is continuously present or present for long periods
- Zone 1 Zone in which an explosive atmosphere is likely to occur in normal operation
- Zone 2 Zone in which an explosive atmosphere is not likely to occur in normal operation, and if it occurs it will exist only for a short time.

Table 15(5)

Relationship between T Class and Maximum Surface Temperature

T Class	Maximum Surface Temperature (°C)
T1	450
T2	300
T3	200
T4	135
T5	100
T6	85

Code 16 OVERHEAD LINE INSTALLATIONS

16A General

16B Installation of Overhead Lines

16C Joints of Overhead Lines

16D Service to Building

16E Conductor to Ground Clearance

- (1) Termination onto a building
- (2) Any point of the span

16F Pole

- (1) Material
- (2) Installation

16G Stay Wire

- (1) Material
- (2) Installation

16H Carrier Wire

- (1) Material
- (2) Installation

16I Earthing of Metallic Parts and Earth Leakage Protection

Code 16 OVERHEAD LINE INSTALLATIONS

16A General

Hard-drawn copper or solid aluminium PVC insulated PVC sheathed armoured or non-armoured single or multi-core or bunched cables, suspended on carrier wires, are acceptable for low voltage overhead line installations.

16B Installation of Overhead Lines

Cables for overhead lines should be securely supported on insulators. Alternatively, the cables should be attached to the carrier wire by self-retaining nylon fasteners of suitable size and strength and evenly spaced at suitable intervals to prevent undue stress on the cables.

16C Joints of Overhead Lines

- (a) Mid-span joints in overhead lines are not acceptable.
- (b) Straight joints, if any, should be made at the pole and should be properly designed, installed and insulated from the pole.

16D Service to Building

- (a) Where overhead lines enter into a building, the cables should be taken into the building through an arrangement with sufficient size and adequate protection from mechanical damage.
- (b) A separate earthing system at each building comprising earth electrodes, earthing conductors, earthing terminal etc. should be provided for each building fed from an overhead line supply.

16E Conductor to Ground Clearance

(1) Termination onto a building

In cases where an overhead line is to be terminated onto a building and it is not possible to achieve the required height by attaching the overhead line to the roof of the building, an extension pole should be fitted to the building, and the overhead line should be attached to the pole. Alternatively a pole should be erected adjacent to the building, and the supply cable from the pole to the building should be adequately protected from mechanical damage. For this purpose, underground armoured cables are acceptable.

(2) *Any point of the span*

The conductor to ground clearance of any point of the span of the overhead line should be not less than:

- (a) 5.8 m across any space accessible to vehicular traffic such as roads, car parks etc., or
- (b) 5.2 m in other positions; or
- (c) the tallest height restriction where height restriction is imposed on any location.

16F **Pole**

(1) *Material*

Poles should be made of steel, concrete, wood or other durable material of adequate strength.

(2) *Installation*

Poles should be erected in such a manner to withstand the forces acting on them due to overhead lines, carrier wires and wind etc.

16G **Stay Wire**

(1) *Material*

Stay wires should be of stranded galvanised steel not less than seven strands each having a nominal diameter of 2 mm (i.e. 7/2 mm).

(2) *Installation*

- (a) Stay wires may be used at the terminal poles or at poles where the overhead line changes direction. The stays wires, where used, should be placed in such a manner so as to take the pull exerted by the lines effectively.
- (b) Stay wires should be properly and securely terminated at each end so as to withstand the forces acting on the wires.

16H **Carrier Wire**

(1) *Material*

Carrier wires should be made of a stranded galvanised steel having a nominal overall diameter not less than 4 mm.

(2) *Installation*

Carrier wires should be firmly fixed to supports.

16| **Earthing of Metallic Parts and Earth Leakage Protection**

- (a) The metallic poles, the steel carrier wires and the stay wires, should be permanently and effectively earthed at the main earthing terminals at both ends of the circuit. To meet this requirement the steel carrier wire may be used as a protective conductor to earth the metallic poles and stay wires provided that the electrical continuity of the carrier wire is durably maintained throughout the entire run of the circuit.
- (b) Where an electrical installation is supplied from overhead line system, the installation should be protected against earth leakage by residual current device (see Code 11B).

Code 17 DISPLAY OF LABELS AND NOTICES

17A Warning Notice for Substations and Switchrooms

- (1) Warning notice for substations
- (2) Warning notice for switchrooms
- (3) Warning notice for distribution boards
- (4) Warning notice for high voltage installations

17B Warning Notice for Connection of Earthing and Bonding Conductors

17C Warning Notice for Repair

17D Notice of Periodic Testing of Electrical Installations

17E Notice of Testing for Residual Current Devices

17F Warning Notice for Installation Having Both New and Old Cable Colours

Code 17 DISPLAY OF LABELS AND NOTICES

17A Warning Notice for Substations and Switchrooms

(1) *Warning notice for substations*

'DANGER—SUBSTATION, UNAUTHORISED ENTRY PROHIBITED' and '危險——電力分站，未經授權不得內進' in legible letters and characters. 'DANGER' and '危險' should not be less than 30 mm high and each other letters and characters not less than 15 mm high, either painted on the outside of the door of the substation, or engraved on plastic boards permanently fixed on the outside of the door of the substation.

(2) *Warning notice for switchrooms*

'DANGER—ELECTRICITY, UNAUTHORISED ENTRY PROHIBITED' and '危險——有電，未經授權不得內進' in legible letters and characters. 'DANGER' and '危險' should not be less than 30 mm high and each other letter and characters not less than 15 mm high, either painted on the outside of the door of the switchroom or engraved on plastic boards permanently fixed on the outside of the door of the switchroom.

(3) *Warning notice for distribution boards*

'DANGER' and '危險' in red legible letters and characters each not less than 10 mm high, displayed at or near each distribution board is acceptable.

(4) *Warning notice for high voltage installations*

'DANGER – HIGH VOLTAGE' and '危險 – 高壓' in legible letters and characters each not less than 30 mm high should be displayed at the high voltage installation.

'DANGER – HIGH VOLTAGE' and '危險 – 高壓' in legible letters and characters each not less than 50 mm high should be displayed along a cable run easily accessible by public. (Remarks : An interval of not more than 3m is generally acceptable. Warning notices 'DANGER – HIGH VOLTAGE' and '危險 – 高壓' currently used for low voltage installation should no longer be used.)

17B Warning Notice for Connection of Earthing and Bonding Conductors

'SAFETY EARTH CONNECTION—DO NOT REMOVE' and '安全接地終端——切勿移去' in legible letters and characters each not less than 5

mm high to be permanently fixed at or near the point of connection of every earthing conductor to an earth electrode, and at or near each main bonding connection.

17C **Warning Notice for Repair**

'CAUTION—EQUIPMENT UNDER REPAIR' and '小心——器具待修' and/or 'CAUTION—MEN AT WORK (小心——工程進行中)' and/or 'ELECTRICAL WORK IN PROGRESS, KEEP POWER OFF (電力工作進行中·切勿開啟電源)' in legible letters and characters each not less than 50 mm high, displayed at or near the electrical equipment and at the isolating device associated with the equipment is acceptable. Examples for display of such notices are:

- (a) on a distribution board or switch or circuit breaker controlling the circuit on which work is being carried out; and
- (b) at or near any equipment where bare or live parts which are normally protected from direct contact are uncovered and exposed for work to be carried out.

17D **Notice of Periodic Testing of Electrical Installations**

'This installation must be tested and certified by a grade A/B/C/H/R* electrical worker before (date) **' and '本裝置須於_____年_____月_____日**前由 A/B/C/H/R* 級電業工程人員測試及發出證明書' in legible letters and characters each not less than 5 mm, permanently fixed at or near the main distribution board or main switch of a periodically tested electrical installation referred to in regulation 20 (see Code 20) is acceptable.

(Note: * delete whichever inapplicable.

** the date entered on this notice is the date of the next certificate to be issued and is to be up-dated by the registered electrical worker who is certifying the installation.)

17E **Notice of Testing for Residual Current Devices**

'Press to test at least quarterly' and '最少每三個月按鈕測試' in legible letters and characters each not less than 5 mm, permanently fixed at or near a residual current device is acceptable.

17F **Warning Notice for Installation Having Both New and Old Cable Colours**

‘小心！此電力裝置包含新舊顏色電線。在進行加裝、改裝或修理工作前，務須正確識別所有導體。’ and ‘CAUTION! THIS INSTALLATION HAS BOTH NEW AND OLD CABLE COLOURS. GREAT CARE SHOULD BE TAKEN BEFORE UNDERTAKING EXTENSION, ALTERATION OR REPAIR THAT ALL CONDUCTORS ARE CORRECTLY IDENTIFIED.’ in black legible letters and characters, and in yellow background. ‘小心’ and ‘CAUTION’ should not be less than 10 mm in height and other letters and characters not less than 5 mm in height. The warning notice should have a minimum size of 100mm (width) × 75mm (height). It should be displayed at or close to the nearest upstream distribution board (e.g. main switchboard, sub-main distribution board or consumer unit) of an installation where cables in new colour code are installed in an existing installation with old colour coded cables.

Code 18 ALTERATIONS AND ADDITIONS

18A Requirements for Alterations or Additions to a Fixed Installation

18B Approval from the Electricity Supplier

Code 18 ALTERATIONS AND ADDITIONS

18A Requirements for Alterations or Additions to a Fixed Installation

- (a) For any alteration or addition to an existing fixed installation, the registered electrical worker responsible for the work should:
 - (i) carry out the alteration or addition in compliance with the Wiring Regulations,
 - (ii) verify that the alteration or addition does not impair in any way the safety of the existing installation, and
 - (iii) verify that new colour cables are installed in compliance with the requirements in Appendix 18.
- (b) For the purposes of subparagraph (a) above, the following essential items should be checked and ascertained by the responsible registered electrical worker:
 - (i) the total current demand for the installation after the alteration or addition should not exceed the approved loading;
 - (ii) the ratings and the conditions of the existing electrical equipment of the affected parts are suitable and adequate for the altered circumstances; and
 - (iii) the protection against overcurrent, earth fault currents and dangerous earth leakage currents for the affected parts is altered as necessary for the altered circumstances.
- (c) In the case of an alteration or addition to an installation which is connected to rising mains, the owner of the installation should, before commencing any alteration or addition, obtain agreement from the owner of the rising mains by completing form "Confirmation of Agreement from Owner of Rising Mains for Connection of Electrical Installation with an Increased Current Demand" provided by Electricity Supplier if the new current demand of the installation after the alteration or the addition will exceed the existing approved loading before the alteration or addition is carried out on the installation.

18B Approval from the Electricity Supplier

Any person who wishes to have his electricity supply increased over and above the approved loading, or extended beyond the premises to which the supply is originally intended, should obtain prior approval from the electricity supplier concerned *before* any alteration or addition is carried out.

**Code 19 FIRST INSPECTION, TESTING AND
CERTIFICATION**

19A Certification on Completion of an Installation

19B Work Completion Certificate

Code 19 FIRST INSPECTION, TESTING AND CERTIFICATION

19A Certification on Completion of an Installation

(a) Certification on the design—

After the design is completed for new work, alteration or addition to be made to an existing installation, it should be certified, before installation, by a registered electrical worker that the relevant design is in compliance with the Wiring Regulations.

(b) Certification on the installation—

After an installation is completed, or work completed subsequent to repair, alteration or addition made to an existing installation and before it is energized for use, it should be inspected, tested and certified by a registered electrical worker that the wiring installation is completed to the relevant design and is in compliance with the Wiring Regulations.

(c) If the installation, alteration or addition is designed, inspected and tested by the same electrical worker, he should certify both the design and the installation as required under subparagraphs (a) and (b).

(d) In the case of a repair, alteration or addition to an installation, only the affected parts of the installation need to be inspected, tested and certified.

(e) Certification as required in subparagraphs (a) and (b) should be made on prescribed forms specified by the Director (i.e. Work Completion Certificate).

19B Work Completion Certificate

(a) For the purpose of regulations 19(1) and 19(2), the registered electrical worker(s) and contractor(s) should sign work completion certificate(s) (i.e. Form WR1 but not Form WR1(A)) and issue it to the owner after completion of the electrical installation or any work subsequent to repair, alteration or addition to an existing installation. This should be done before the installation is energised.

(b) It is recommended that in order to expedite the application for supply connection, a copy of the certificate may be copied to the electricity supplier concerned.

(c) Where an installation is subdivided into more than one part and individual parts are not inspected and tested by the same registered electrical worker, a single certificate (i.e. Form WR1) may be issued and certified by a registered electrical worker to cover a number or all of the individual parts, provided that he has received the appropriate certificates

(i.e. Form WR1(A)) signed by other registered electrical workers for the individual parts. In brief, Form WR1 is used for issuing to owner of the fixed electrical installation, whereas Form WR1(A) is used for issuing to registered electrical worker.

- (d) Every certificate should be signed by the registered electrical worker and/or the registered electrical contractor as required in the certificate. Where a registered electrical contractor is not employed as permitted under section 35(3) of the Electricity Ordinance, the owner of the electrical installation who employs the registered electrical worker to do the work should sign as the registered electrical contractor and should then assume responsibilities of a registered electrical contractor.
- (e) Proforma of the Work Completion Certificate can be obtained from EMSD's Customer Services Office or downloaded from www.info.gov.hk/forms.

Code 20 PERIODIC INSPECTION, TESTING AND CERTIFICATION

20A Fixed Electrical Installations Specified in Regulation 20(1)

- (1) Places of public entertainment
- (2) Premises for the manufacturing or storing of dangerous goods
- (3) High voltage fixed installations

20B Fixed Electrical Installations Specified in Regulations 20(2), 20(3) and 20(4)

20C Periodic Test Certificate

Code 20 PERIODIC INSPECTION, TESTING AND CERTIFICATION

20A Fixed Electrical Installations Specified in Regulation 20(1)

Fixed electrical installations having any approved loading at the following types of premises are required to be inspected, tested and certified at least once every year:

(1) *Places of public entertainment*

Places of public entertainment as defined in the Places of Public Entertainment Ordinance (Cap. 172) including any place, building, erection or structure, whether temporary or permanent, capable of accommodating the public in or on which a public entertainment is present or carried on whether on one occasion or more; including any concert, stage play, stage performance or other musical, dramatic or theatrical entertainment or any part thereof, any cinematography display, lecture, story-telling, circus, exhibition of pictures, photographs or books, exhibition of dancing, conjuring or juggling, acrobatic performance exhibition of abnormal persons or animals, any sporting exhibition or contest, any bazaar, any merry-go-round, flying wheel or other mechanical device designed for amusement.

(2) *Premises for the manufacturing or storing of dangerous goods*

(a) Premises for the manufacturing or storing of dangerous goods classified under categories of the Dangerous Goods (Application and Exemption) Regulations (Cap. 295), previously known as the Dangerous Goods (Classification) Regulations, are as follows:

Category 1 — explosives and blasting agents

Category 2 — compressed gases

Category 3 — corrosive substances

Category 4 — poisonous substances

Category 5 — substances giving off inflammable vapour

Category 6 — substances which become dangerous by interaction with water

Category 7 — strong supporters of combustion

Category 8 — readily combustible substances

Category 9 — substances liable to spontaneous combustion

Category 9A — combustible goods exempted from sections 6 to 11 of the Dangerous Goods Ordinance

Category 10 — other dangerous substances

- (b) Examples of the above are dangerous goods stores, dangerous goods storage tanks, gas stations, petroleum and diesel filling stations and liquefied petroleum gas stations etc.

(3) *High voltage fixed installations*

- (a) Premises having high voltage fixed installations that are fed directly from a high voltage supply are required to be inspected, tested and certified at least once every year. Examples of such installations are:
 - (i) high voltage switchrooms and substations under the control of the owners (e.g. of a large commercial complex);
 - (ii) high voltage fixed installations such as large plant and machinery.
- (b) High voltage electrostatic equipment and high voltage discharge lighting such as neon signs which are fed from low voltage supplies are not considered as high voltage fixed installations. They are considered as part of a low voltage installation.

20B **Fixed Electrical Installations Specified in Regulations 20(2), 20(3) and 20(4)**

- (1) Fixed electrical installations in factories and industrial undertakings having an approved loading exceeding 200 amperes, single or three phase at nominal low voltage are required to be inspected, tested and certified at least once every five years.
- (2) Fixed electrical installations in premises other than those mentioned in Codes 20A or 20B(1) above having an approved loading exceeding 100 amperes single or three phase at nominal low voltage are required to be inspected, tested and certified at least once every five years. Examples of such installations are rising mains, protective conductors, earthing facilities, and power supply to lifts, water pumps, public lighting and other communal services in the premises, fixed electrical installations in domestic premises and offices etc.
- (3) Low voltage fixed electrical installation located in one of the following type of premises should be inspected, tested and certified at least once every five years:
 - (a) hotel or guest house;
 - (b) hospital or maternity home;
 - (c) school;
 - (d) premises of the institutions listed in section 2 of the Education Ordinance (Cap. 279) including technical institutions and universities;
 - (e) child care centre; and

- (f) premises that the Director may, by notice posted to or served on the owner, specify that he considers could cause great harm in the event of an electrical accident.

20C **Periodic Test Certificate**

- (1) The owner of an installation which requires periodic testing should deliver a test certificate to the Director for endorsement within 2 weeks after the date of the certificate (i.e. "Date Signed" on Form WR2 by REC). The owner should submit a current endorsement fee for each certificate delivered to the Director.
- (2) Where an installation is subdivided into more than one part and individual parts are not inspected and tested by the same registered electrical worker, a single test certificate may be issued and certified by a registered electrical worker to cover a number or all of the individual parts, provided that he has received the appropriate test certificates signed by other registered electrical workers for the individual parts.
- (3) The test certificates should be in prescribed forms specified by the Director and proforma of the certificates can be obtained from EMSD's Customer Services Office or downloaded from www.info.gov.hk/forms.
- (4) All installations which require periodic testing and are connected to electricity supplies on or before the commencement date of the Wiring Regulations (1 June 1992) are considered to have been inspected, tested and certified on that date.

Code 21 PROCEDURES FOR INSPECTION, TESTING AND CERTIFICATION

21A Inspection of Low Voltage Installations

21B Testing of Low Voltage Installations

- (1) Safety
- (2) Sequence of tests
- (3) Continuity of protective conductors
- (4) Continuity of ring final circuit
- (5) Insulation resistance
- (6) Polarity
- (7) Earth electrode resistance
- (8) Earth fault loop impedance
- (9) Functions of all devices including protective devices
- (10) Additional checks for installations in hazardous environment

21C Inspection of High Voltage (H.V.) Installations

21D Testing of High Voltage Installations

- (1) Safety
- (2) Testing requirements

21E Points to be Noted by Registered Electrical Workers

- (1) Signing of certificates
- (2) Dates of tests, inspections and certification
- (3) Items to be inspected and tested
- (4) Related ordinance and regulations to be observed
- (5) Energisation of installation for testing purposes
- (6) Standard symbols to be used

21F Power Suspension Arrangement for Periodic Inspection, Testing and Certification (PITC) Work on Main Switchboard connecting to Power Company's Transformer

Code 21 PROCEDURES FOR INSPECTION, TESTING AND CERTIFICATION

21A Inspection of Low Voltage Installations

A visual inspection should be made to verify that the electrical equipment as installed is correctly selected and erected in accordance with the Wiring Regulations and this CoP, and that there is no apparent damage. The visual inspection should include a check on the following items, where appropriate:

- (a) adequacy of working space, access, and maintenance facilities,
- (b) connections of conductors,
- (c) identification of conductors,
- (d) adequacy of the sizes of conductor in relation to current carrying capacity and voltage drop,
- (e) correct connections of all equipment with special attention to socket outlets, lampholders, isolators, switches, residual current devices, miniature circuit breakers, and protective conductors,
- (f) presence of fire barriers and protection against thermal effects,
- (g) methods of protection against direct contact with live parts (including measurement of distances where appropriate), i.e. protection by insulation of live parts, or protection by barriers or enclosures,
- (h) presence of appropriate devices for isolation and switching,
- (i) choice and setting of protective and indicative devices,
- (j) labelling of circuits, fuses, protective devices, switches, isolators and terminals,
- (k) selection of equipment and protective measures appropriate to adverse environmental conditions,
- (l) presence of danger and warning notices,
- (m) presence of diagrams, instructions and other similar information,
- (n) connection of single pole devices for protection or switching in phase conductors only,
- (o) methods of fault protection,
- (p) prevention of mutual detrimental influence,
- (q) presence of undervoltage protective devices,
- (r) erection method.

21B **Testing of Low Voltage Installations**

(1) *Safety*

Precautionary measures should be taken during testing and the method of tests should be such that no danger to persons or property can occur even if the circuit being tested is defective.

(2) *Sequence of tests*

- (a) The following items, where relevant, are to be tested preferably in the sequence indicated below:
 - (i) continuity of protective conductors, including main and supplementary equipotential bonding,
 - (ii) continuity of ring final circuit conductors,
 - (iii) insulation resistance,
 - (iv) polarity,
 - (v) earth electrode resistance,
 - (vi) earth fault loop impedance,
 - (vii) functions of all protective devices,
 - (viii) functions of all items of equipment.
- (b) In the event of any test indicating failure to comply, that test and those preceding, the results of which may have been influenced by the fault indicated, should be repeated after the fault has been rectified.

(3) *Continuity of protective conductors*

Every protective conductor, including all conductors and any extraneous conductive parts used for equipotential bonding should be tested for continuity. The test should be made by connecting together the neutral and protective conductors at the mains position and checking between earth and neutral at every outlet by a continuity tester, which should show a reading near zero.

(4) *Continuity of ring final circuit*

- (a) The ring circuit should be tested from the distribution board. The ends of the two cables forming the phase conductor should be separated, and a continuity test should show a reading near zero between the two; the same tests to be made between the two cables that form the neutral conductor, and between the two cables that form the protective conductor (see Figure 21(1)).
- (b) The testing method in subparagraph (a) above is only applicable when the ring circuit has been inspected throughout, prior to the test, to ascertain that no interconnection (multi-loops) exists on the ring circuit. Otherwise, the testing methods stipulated in Part 3 of the Guidance Note 3 to BS7671, should be adopted instead.

(5) *Insulation resistance*

- (a) A suitable d.c. insulation tester should be used to measure insulation resistance. Care should be taken to ensure that the insulation of the equipment under test can withstand the test voltage without damage.
- (b) The main switchboard and each distribution circuit should be tested separately. To carry out this test, it is acceptable to divide large installation into sections with groups of outlets. The term 'outlet' in this case includes every point and every switch. A socket outlet or appliance or luminaire incorporating a switch is regarded as one outlet.
- (c) When measured with all fuse links in place, all switches and circuit breakers (including, if practicable, the main switch) closed and all poles or phases of the wiring electrically connected together, the insulation resistance to earth should not be less than the appropriate values given in Table 21(1), as illustrated in Figure 21(2)A and 21(2)B.
- (d) When measured between all conductors connected to any one phase or pole of the supply and, in turn, all conductors connected to each other phase or pole, as shown in Figure 21(3)A and 21(3)B, the insulation resistance should not be less than the appropriate values in Table 21(1).
- (e) In carrying out the test:
 - (i) wherever practicable, all lamps should be removed and all current using equipment (including load on socket outlets) should be disconnected and all local switches controlling lamps or other equipment should be closed;
 - (ii) where the removal of lamps and/or the disconnection of current using equipment is impracticable, the local switches controlling such lamps and/or equipment should be open;
 - (iii) electronic devices connected in the installation should be isolated or short circuited where appropriate so that they are not damaged by the test voltage.
 - (iv) where the circuits contain voltage sensitive devices, the test should measure the insulation resistance to earth with all live conductors (including the neutral) connected together.
- (f) Where equipment is disconnected for the test and the equipment has exposed conductive parts required to be connected to protective conductors, the insulation resistance between the exposed conductive parts and all live parts of the equipment should be measured separately and should have a minimum insulation resistance not less than 1 megohm.

(6) *Polarity*

- (a) A test of polarity (e.g. as illustrated in Figure 21(4)) should be carried out to verify that:
 - (i) every fuse, single-pole control and protective device is connected in the phase conductor only;
 - (ii) centre-contact bayonet and Edison-type screw lampholder to IEC 60238 in circuits having an earthed neutral conductor, have their outer or screwed contacts connected to that neutral conductor; and
 - (iii) wiring has been correctly connected to socket outlets and similar accessories. (Note: Exposed conductive parts should be correctly connected to earth.)

(7) *Earth electrode resistance*

- (a) A proper earth electrode resistance tester should be used to measure earth electrode resistance. An alternating current at 50 Hz of a steady value is passed between the earth electrode T and an auxiliary earth electrode T_1 placed at a separation distance recommended by the manufacturer of the tester but in any case should not be less than 20 metres away. A second auxiliary earth electrode T_2 , which may be a metal spike driven into the ground, is then inserted half-way between T and T_1 , and the voltage drop between T and T_2 , divided by the current flowing between T and T_1 , gives a measured earth electrode resistance of earth electrode T.
- (b) For an electrical installation having four or more earth electrodes which are installed more or less in line, following a general direction not exceeding 15° deviation and with separation between adjacent electrodes not less than the recommended distance by the manufacturer of the tester but in any case not less than 20 metres, these electrodes can be used in turn as the auxiliary electrodes for the purpose of measuring the earth electrode resistances.
- (c) The following alternative method for measuring the earth electrode resistance may be used if the electricity supply is connected. A loop impedance tester should be connected between the phase conductor at the origin of the installation and the earth electrode with the test link open, and a test performed. This impedance reading could be treated as the electrode resistance.

(8) *Earth fault loop impedance*

- (a) The earth fault loop impedance should be measured by a phase-earth loop tester with a scale calibrated in ohms.
- (b) The earth fault loop impedance should not exceed the requirements of Code 11.
- (c) Before the test begins, it is essential to establish, by inspection, that the earthing conductor and all relevant earth connections are in place, and that the bonding connection to electricity supplier's earthing facilities is disconnected. Measures should be taken, during the impedance tests especially when the earth leakage protective devices are effectively removed for the duration of the tests, to ensure that the installation is not being used other than by person(s) carrying out the tests.

(9) *Functions of all devices including protective devices*

(a) Functional Test of RCD

- (i) Function of residual current devices should be checked by a residual current device tester simulating an earth fault in order to verify its effective operation. The in-built test button should also be tested for proper functioning. One of the testing methods is specified in subparagraph (ii) and (iii) below. Other testing methods complying with relevant national/international standards are also acceptable.
 - (ii) The test should be made on the load side of the RCD between the phase conductor of the protected circuit and the associated cpc. The load should be disconnected during the test.
 - (iii) For general purpose RCDs to IEC 61008 or RCBOs to IEC 61009, with a leakage current flowing equivalent to 50% of the rated tripping current of the RCD, the device should not open. When a leakage current is flowing equivalent to 100% of the rated tripping current of the RCD, the device should open in less than 300 ms unless it is of "Type S" (or selective) which incorporates an intentional time delay, when it should trip within the time range from 130 ms to 500 ms.
- (b) Function of other protective devices, such as miniature circuit breakers, moulded case circuit breakers, air circuit breakers, fused switches, switch-fuses and protective relays etc. should be checked by hand operation as appropriate.
 - (c) Function of all items of equipment such as isolators, switches and indicative devices should be checked by hand operation.

- (d) Secondary Injection Test
 - (i) The overload and fault current protection characteristics of protection relays should be verified with secondary injection test.
 - (ii) The test should be carried out by injecting a.c. of different magnitudes into the relay terminals and measuring the relay operating time. The operating time should be checked against the manufacturer's data sheet. The waveform and the accuracy of the a.c. current injected shall be in accordance with the requirements specified by the manufacturer.
 - (iii) Safety precautions for work on low voltage specified under Code 4G should be observed.

(10) *Additional checks for installations in hazardous environment*

The following additional checks, where appropriate, should be carried out for installations in hazardous environment:

- (a) Where appropriate, the area involved should be checked to ensure 'gas free' condition before insulation and earth fault loop impedance test are carried out.
- (b) All equipment should be suitably protected according to the types of protection under Code 15. The integrity of the type of protection provided for the equipment should not be jeopardised by the method of installation. No alteration that may invalidate the conditions of protection can be used.
- (c) Equipment should be kept clean and free from accumulation of dust, foreign particles and deleterious substances. Equipment is kept free from condensation.
- (d) All lamps, fuses and replaceable parts should be checked so that correct rating and types are being used.
- (e) The surface temperature of all equipment should be appropriate to the type of protection being provided.

21C Inspection of High Voltage (H.V.) Installations

Inspection of H.V. installations should follow those for L.V. installations listed in Code 21A with additional checks on the following items where relevant:

- (a) provision of suitable locking facilities for every entry to an H.V. switchroom/substation;
- (b) continuity of protective conductors especially the bonding of all exposed conductive parts; and
- (c) provision of padlock facilities for shutters, key boxes etc.

21D **Testing of High Voltage Installations**

(1) *Safety*

- (a) Precautionary measures, including those applicable ones stated in Code 4G and 4H, should be taken and the methods of tests should be such that no danger to persons or property can occur even if the circuit being tested is defective.
- (b) A H.V. test area should be screened or fitted with barrier with appropriate label / sign attached to avoid unauthorized access. Responsible person should be present throughout the duration of the tests, and the area should be continually watched while testing is in progress.

(2) *Testing requirements*

- (a) Testing for High Voltage installations should be referred to relevant recognised standards, manufacturers' recommendation, operations and maintenance instructions.
- (b) Where the procedures involve the removal of circuit main earths, that is, testing under a sanction-for-test, the earths (except those without lock, for example, portable earth) should be secured with working locks. The keys to these locks should be retained by person in-charge, who will remove and replace the earths as requested.
- (c) Live voltage and phase checking on high voltage equipment may only be undertaken by person in-charge, with assistance if necessary from a person who has been specifically trained for live voltage and phase checking acting on verbal instructions from person in-charge.
- (d) Where high voltage tests are to be undertaken, a sanction-for-test should be issued to person in-charge who is to be present throughout the duration of the tests.

21E **Points to be Noted by Registered Electrical Workers**

(1) *Signing of certificates*

- (a) A registered electrical worker should not sign certificates for tests and inspections unless he has carried out or supervised the tests and inspections on site, and is satisfied with the results of the tests and inspections.
- (b) A registered electrical worker should not sign certificates for tests and inspections carried out by other registered electrical workers unless:
 - (i) he has received the appropriate certificates for the tests and inspection results certified by other registered electrical workers;

- (ii) he is satisfied with the results of the tests and inspections;
- (iii) he is satisfied that the certificates or inspection reports submitted to him are completed and signed by registered electrical worker of appropriate grade and in compliance with the Wiring Regulations; and
- (iv) he has taken reasonable steps to ascertain that the tests and inspections have been genuinely carried out.

(2) *Dates of tests, inspections and certification*

It is acceptable that the actual dates of all tests and inspections be different from the date of certification. However, for the registered electrical worker to be satisfied that the results of these tests and inspections are valid, he must ensure that the final inspections, insulation resistance tests and functional tests of protective and control devices are carried out as close to the date of certification (i.e. "Date Signed" on Form WR2 by REW) as possible. Other tests and inspections listed under Code 21 may be carried out at a reasonable time, normally not exceeding one month, before the date of certification (i.e. "Date Signed" on Form WR2 by REW) provided that due precautions have been taken to ensure that nothing will have affected the results of these tests and inspections during this period.

(3) *Items to be inspected and tested*

List of items to be inspected and tested for initial tests and periodic tests are shown in Code 22D.

(4) *Related ordinance and regulations to be observed*

Other statutory requirements in relation to electrical installations should also be referred to during the inspection, including in particular:

- (a) (i) Fire Services Ordinance,
(ii) Fire Services (Installations and Equipment) Regulations,
- (b) (i) Fire Safety (Commercial Premises) Ordinance,
(ii) Fire Safety (Buildings) Ordinance,
- (c) (i) Factories and Industrial Undertakings Ordinance,
(ii) Factories and Industrial Undertakings (Electricity) Regulations,
(iii) Construction Sites (Safety) Regulations,
(iv) Factories and Industrial Undertaking (Work in Compressed Air) Regulations,
(v) Factories and Industrial Undertakings (Spraying of Inflammable Liquid) Regulations,

- (vi) Factories and Industrial Undertakings (Cargo and Container Handling) Regulations,
- (d) (i) Dangerous Goods Ordinance,
(ii) Dangerous Goods (General) Regulations.

(5) *Energisation of installation for testing purposes*

To energise an installation or part of it for testing by a registered electrical worker prior to the issue of the relevant certificate is acceptable.

(6) *Standard symbols to be used*

Standard symbols to Appendix 8 should be used in schematic diagrams where appropriate.

21F **Power Suspension Arrangement for Periodic Inspection, Testing and Certification (PITC) Work on Main Switchboard connecting to Power Company's Transformer**

- (a) In order to ensure personal safety of the electrical workers and avoid affecting building power supply in case of electrical accident, the power company's electricity supply should be cut off in carrying out PITC work on main switchboard that is connected to power company's transformer.
- (b) For WR2 submission involving the above-mentioned main switchboard, the power company's record (e.g. power company's relevant correspondences or receipt, etc.) for temporary disconnection of electricity supply shall also be submitted.
- (c) The building owners, Incorporated Owners and property management companies may contact the power company to check for the opportunities of carrying out the PITC work at the same time with the power company's equipment maintenance work so as to avoid repeated power suspensions and hence minimize the disturbance to the building users.
- (d) Furthermore, the Registered Electrical Contractor should also closely collaborate with the building owners, Incorporated Owners and property management companies to work out the power suspension arrangement and temporary measures that meet the building operational needs with the aim to minimizing disturbance to the building users resulting from the PITC work.

Table 21(1)*Minimum Values of Insulation Resistance*

Circuit Nominal Voltage (Volts)	Test Voltage d.c. (Volts)	Minimum Insulation Resistance (megohms)
Extra-low voltage circuits when the circuit is supplied from a safety isolating transformer/SELV	250	0.5
Up to and including 500V with the exception of the above cases	500	1.0
Above 500V	1 000	1.0
Above LV	Insulation of cables above LV shall be measured by pressure test and the values of the insulation test taken before and after the pressure test can be used as a reference	

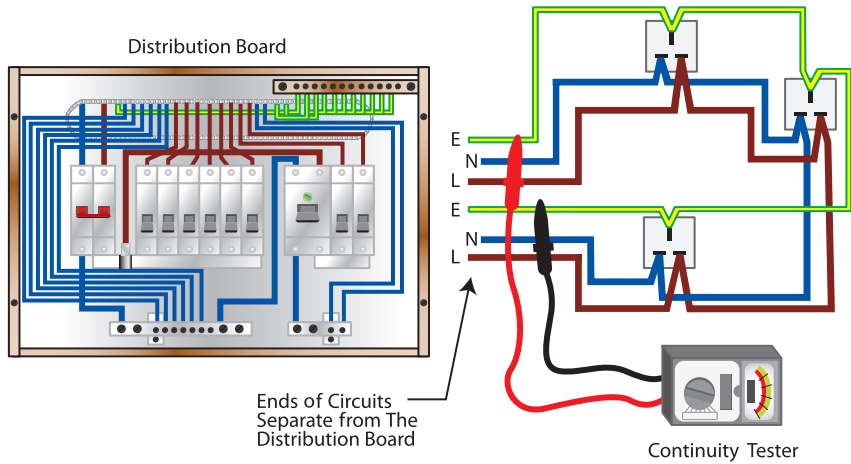

(NOTE : THIS TESTING METHOD IS APPLICABLE SUBJECT TO CODE 21B(4)(b))

CONTINUITY TEST OF RING FINAL CIRCUIT

CODE No.

21

FIGURE No.

21(1)

CODE OF PRACTICE FOR THE ELECTRICITY (WIRING) REGULATIONS

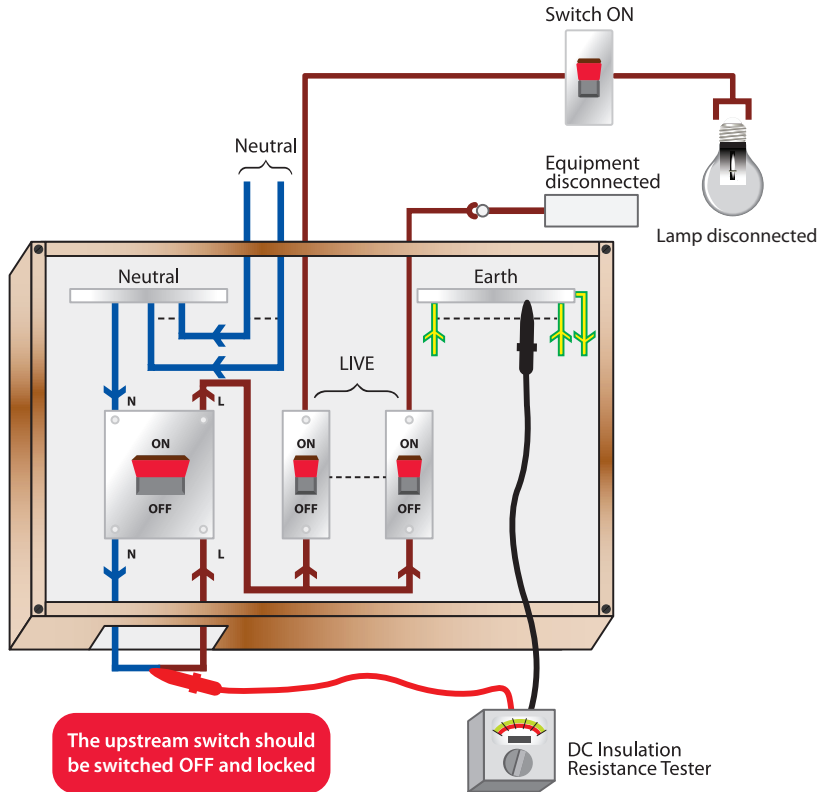

The upstream switch should be switched OFF and locked

1. Main Switch on MCB Board "ON"
2. MCB "ON"
3. All earthing and bonding connections are in place
4. The earthing conductor must connect the main earthing terminal to the means of earthing whilst testing

* The above figure illustrates measurement on phase to earth only. Separate measurement on L-E and N-E are required if the value obtained is unsatisfactory.

CODE No.

21

FIGURE No.

21(2)A

CODE OF PRACTICE FOR THE ELECTRICITY (WIRING) REGULATIONS

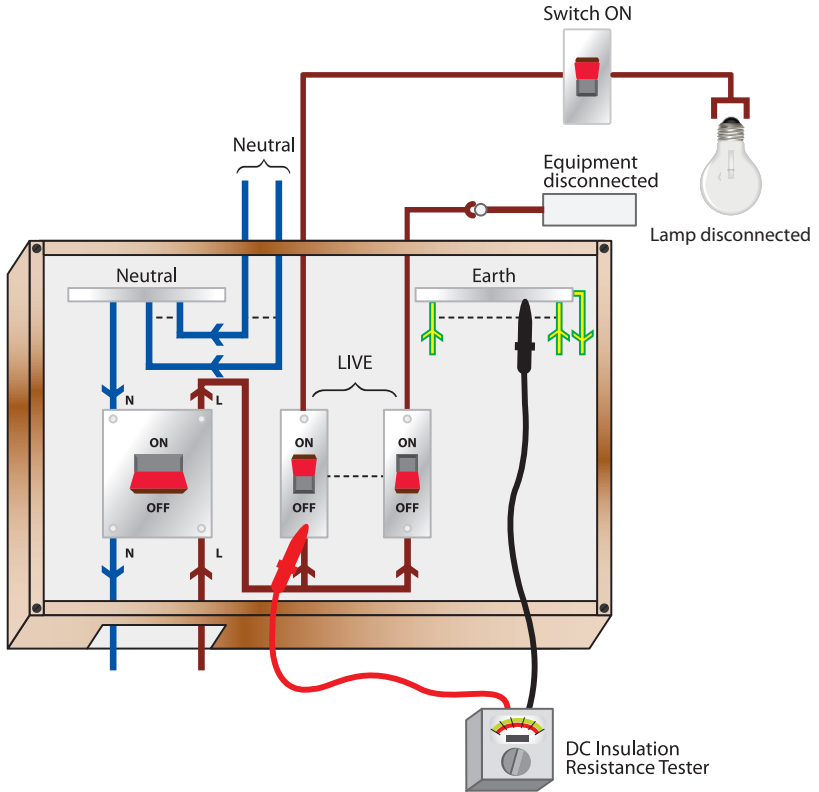

1. Main Switch on MCB Board "OFF" and locked
2. MCB under test "ON", other MCB "OFF"
3. All earthing and bonding connections are in place
4. The earthing conductor must connect the main earthing terminal to the means of earthing whilst testing

CODE No.

21

FIGURE No.

21(2)B

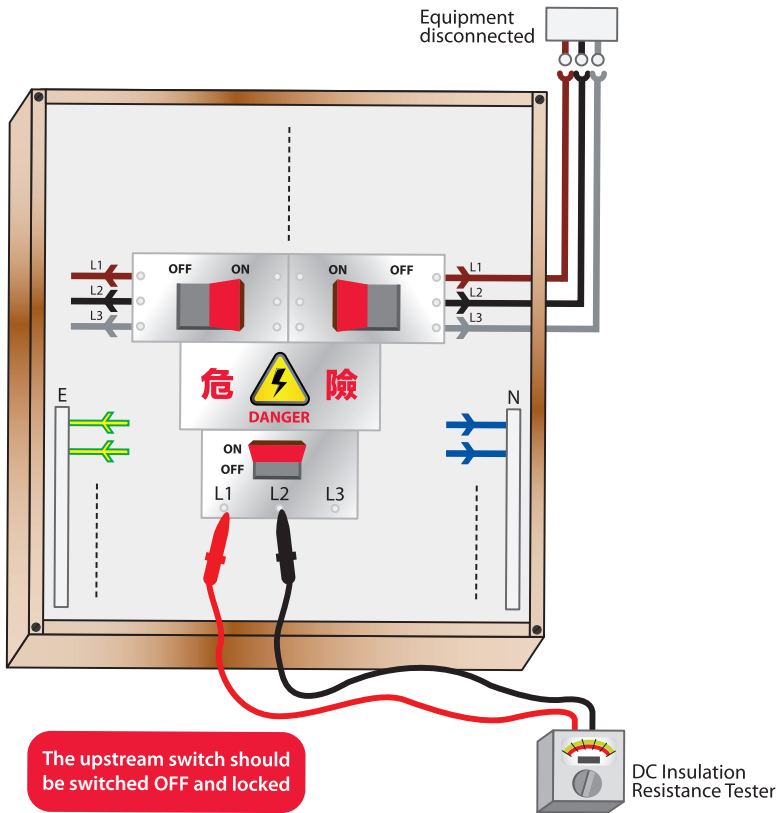

1. Main MCCB "ON"
2. MCB "ON"
3. All earthing and bonding connections are in place
4. The earthing conductor must connect the main earthing terminal to the means of earthing whilst testing

* Repeat test between L1 & L3, L1 & N, L1 & E, L2 & L3, L2 & N, L2 & E, L3 & N, L3 & E and N & E

CODE No.

21

FIGURE No.

21(3)A

CODE OF PRACTICE FOR THE ELECTRICITY (WIRING) REGULATIONS

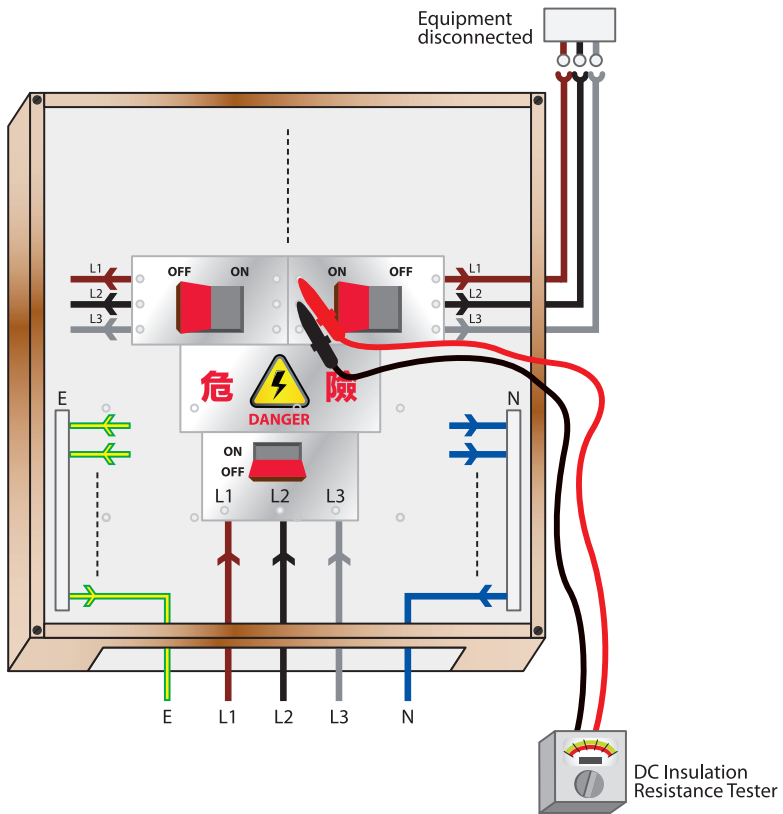

1. Main MCCB "OFF" and locked
2. MCB under test "ON", other MCB "OFF"
3. All earthing and bonding connections are in place
4. The earthing conductor must connect the main earthing terminal to the means of earthing whilst testing

* Repeat test between L1 & L3, L1 & N, L1 & E, L2 & L3, L2 & N, L2 & E, L3 & N, L3 & E and N & E

CODE No.

21

FIGURE No.

21(3)B

FUSES IN OR
CIRCUIT BREAKERS
CLOSED

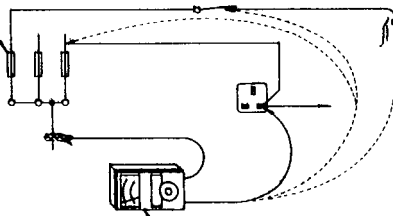

EDISON-TYPE SCREW
OR CENTRE-CONTACT
BAYONET LAMPHOLDER

CONTINUITY TESTER

POLARITY TEST

CODE No. 21

FIGURE No. 21(4)

Code 22 MAKING AND KEEPING OF RECORDS

22A Keeping of Records by the Owner of an Electrical Installation that Requires Periodic Inspection, Testing and Certification

22B Making and Keeping of Records by a Registered Electrical Contractor

22C Types of Records

22D Checklists

- (1) Checklists to be used
- (2) Test sequence
- (3) Checklist for high voltage installations
- (4) Contents of checklists

Code 22 MAKING AND KEEPING OF RECORDS

22A Keeping of Records by the Owner of an Electrical Installation that Requires Periodic Inspection, Testing and Certification

- (a) It is the responsibility of the owner of a periodically tested electrical installation referred to in Regulation 20 (see Code 20) to keep the latest test certificates and make available for inspection by the Director.
- (b) For high voltage fixed installation specified in Regulation 20(1)(c) (see Code 20A), the owner should also make available for inspection a written summary of safety precautions taken for each event of testing and maintenance work carried out on the installation.

22B Making and Keeping of Records by a Registered Electrical Contractor

- (a) It is the responsibility of a registered electrical contractor to make and keep proper records on all electrical works carried out by him and his employees for the lesser of 5 years or the time since his registration as an electrical contractor.
- (b) The registered electrical contractor should also ensure that a copy of the records is made available to the owner of the electrical installation upon completion of work.

22C Types of Records

- (a) For the purpose of Code 22B, a simple single line diagram with symbols to Appendix 8 and simple test results against the lists of items to be inspected and tested detailed in a number of checklists under Code 22D together with test data recorded in the Schedule of Test Results for Electrical Wiring (sample shown in Appendix 13) are acceptable as proper records.
- (b) For the purpose of Code 22A(b), a record of the permit-to-work together with a maintenance log are acceptable.

22D Checklists

(1) Checklists to be used

Depending on the varying requirements as indicated in subparagraphs (a) and (b), records showing the results of the items of inspection and testing performed according to the checklists numbered 1 to 4 in Appendix 13 are generally acceptable.

<u>Requirements</u>	<u>Checklists to be Used</u>
(a) Periodic inspection and testing for a low voltage installation which was connected to supply:	
(i) before 1.1.1985	1
(ii) on or after 1.1.1985 and before 1.6.1992	1 and 2
(iii) on or after 1.6.1992	1, 2 and 3
(b) Inspection and testing carried out upon completion of any electrical work for a low voltage installation	1, 2, 3 and 4

(2) *Test sequence*

Where more than one of the checklists are to be used, the items to be tested should follow the sequence stated in Code 21B(2)(a). The records against the items of the checklists used do not indicate the test sequence.

(3) *Checklist for high voltage installations*

For high voltage installations that are required to be inspected, tested and certified at least once every year, records showing the results of the items of inspection and testing performed according to checklist numbered 5 in Appendix 13 are generally acceptable. Recommendation for testing of high voltage installations given in relevant recognised standards and manufacturers for commissioning and periodic tests, where appropriate, should also be used.

(4) *Content of checklists*

(a) The checklists given in Appendix 13 contain a number of important items to be recorded after an inspection and testing and they are given to indicate generally the minimum requirements for record purposes only. The registered electrical worker carrying out the inspections and tests should fill in test results and the rating of key items where indicated in the checklists; and must certify with date on each individual item of inspection and testing listed. The use of initials for such certification is acceptable if a sample of the initial against a full signature of the registered electrical worker has been given in the records. Where any item listed in the checklists is not applicable to the installation under inspection and testing, the registered electrical worker should also certify it to be so. The use of the abbreviation N/A is acceptable for this purpose. The registered electrical worker should also ensure that all other relevant inspection

and testing results are also properly recorded. All inspection and testing results should be comprehensive; and where necessary, they may be recorded separately and attached as annexes to the checklists.

- (b) Checks stated in Code 21B(10) should be added to relevant checklists for inspection and testing of installations in hazardous environment.

Code 23 & Code 24 (Reserved for Future Uses)

PART II

Code 25 GENERAL WORKMANSHIP

25A Wiring Installation Using Conduits

- (1) General requirements for installation of steel or PVC or plastic conduit
- (2) Wiring installation using steel conduit
- (3) Wiring installation using PVC or plastic conduit

25B Wiring Installation Using Trunkings

- (1) General requirements for installation of steel or PVC or plastic trunking
- (2) Wiring installation using steel trunking
- (3) Wiring installation using PVC or plastic trunking

25C Installation of Cables

- (1) General requirements
- (2) Installation of PVC insulated, PVC sheathed non-armoured cable
- (3) Installation of armoured or metallic sheathed cable
- (4) Use of flexible cable and flexible cord

25D Cable Joint and Cable Termination

- (1) Cable joint
- (2) Boxes for cable joint and cable termination
- (3) General requirements for jointing and termination of cable
- (4) Straight-through joint
- (5) Jointing of protective conductors
- (6) Joints and terminations of non-armoured cables
- (7) Jointing and termination of armoured cables
- (8) Termination of bonding conductors
- (9) Joint and termination for high voltage cables

25E Installation of Socket Outlets

Part II

Code 25 GENERAL WORKMANSHIP

25A Wiring Installation Using Conduits

- (1) *General requirements for installation of steel or PVC or plastic conduit*
 - (a) Where a conduit crosses an expansion joint, special arrangements should be made to allow relative movement to occur on either side of the expansion joint and an example is illustrated in Figure 25(1). A separate circuit protective conductor should be installed to maintain an effective electrical continuity across the expansion joint. The circuit protective conductor should have a cross-sectional area rated to suit the largest live conductor drawn into the conduit.
 - (b) During the building construction, all open ends of the conduit termination, which are liable to be filled with water, moisture or other foreign matter, should be plugged with proper conduit stopping plugs; paper, rag or similar materials should not be used for this purpose. Conduit boxes in similar circumstances should also be similarly plugged to prevent concrete or plaster from entering the boxes during building construction.
 - (c) Proper sealant for the prevention of accumulation of condensed moisture should be applied to ceiling conduit outlets installed in a cool space subject to the influx of warm air.
 - (d) Saddles, for the support of surface conduits, should be provided throughout the entire route at regular intervals. The spacing between adjacent saddles should not be greater than those given in Table 25(1).
 - (e) Cables should be drawn into a conduit by using drawn-in tape or steel wire of the appropriate size. If cable lubricant is used, it should not negatively interact with the cable they lubricate and should not increase the flame spread or decrease the fire resistant properties of the cable.
 - (f) All live conductors of the same circuit should be drawn into the same conduit.
 - (g) The neutral cable of a lighting final circuit using single core cables may be routed in the conduit direct to the lighting point without passing through the switch box.
 - (h) Adaptable boxes should be provided immediately after every two bends, or after a bend plus a total maximum straight run of 10 metres or after a maximum straight run of 15 metres.

- (i) Adjacent or parallel conduits cast in concrete should be separated by a spacing of not less than 25 mm.

(2) *Wiring installation using steel conduit*

- (a)
 - (i) Joint in steel conduits should be made by means of a solid coupler into which the adjacent ends of the two conduits should be inserted and screwed up tightly in order to make the conduit run mechanically and electrically continuous. Exposed screw threads should be painted with anti-corrosion paint.
 - (ii) Running couplings are not recommended.
- (b)
 - (i) Where a steel conduit terminates at a metal casing, the connection should be made by a coupler or a brass adaptor for flexible conduit together with a brass male bush. The connection between the flexible conduit and the adaptor should be securely fixed and protected against ingress of moisture where required. Length of each flexible conduit should be kept to a minimum of not more than 1 m for general applications or 2 m inside false ceiling.
 - (ii) Where the metal casing is painted or enamelled, the electrical continuity between the conduit and the casing should be achieved by means of a separate protective conductor of adequate size, connecting the earthing terminal of the conduit and an earthing terminal inside the metal casing. A copper earthing piece placed between the bush and the metal casing may be used as an earthing terminal of the conduit.
- (c) Conduit should not be bent more than 90 degrees. The internal radius of the bend should not be less than 2.5 times the outside diameter of the conduit.

(3) *Wiring installation using PVC or plastic conduit*

- (a) Conduit bends should have an internal radius of at least 4 times the outside diameter of the conduit.
- (b) The method of carrying out the conduit bends, conduit joints, fixing conduits to boxes without spouts, and the tools and materials to be used should be as recommended by the manufacturer of the conduits.
- (c) Due allowance should be made for the expansion of the PVC tubing at high temperatures. Expansion coupling or other fittings should be included in a straight run of 8 m or more. Saddles or clips should be of sliding fit.
- (d) Boxes for the suspension of luminaires or other equipment, where considerable heat will be produced, should be fitted with steel insert clips. Plastic boxes used for suspension of luminaires or other

equipment should be suitable for the suspended load at the expected working temperature.

25B **Wiring Installation Using Trunkings**

- (1) *General requirements for installation of steel or PVC or plastic trunking*
 - (a) Individual pieces of trunking should be independently supported by means of at least two fixed points per piece. On straight runs, supports for trunking should be fixed at regular intervals with maximum spacings as given in Table 25(2). For runs with bends, supports should be fixed as near to the bend as practicable.
 - (b) Holes in trunking should be drilled, punched or cut by ring saw. After cutting, burrs and sharp edges on the trunking should be removed to prevent abrasion of cables.
 - (c) Cables penetrating through trunking should be protected by conduits except PVC insulated and sheathed cables if such cables form part of a surface wiring system. In such case, the holes in the trunking, through which such cables penetrate, should be fitted with suitable rubber grommets or insulated bushes.

(2) *Wiring installation using steel trunking*

Connection between trunking and equipment should be made by means of a standard flange coupling or an adaptor neck, fabricated or cast. For direct attachment of trunking to electrical equipment, the cable entries should be provided with smooth bore bushes or grommets and the return edge of the lid of the trunking should be left intact.

(3) *Wiring installation using PVC or plastic trunking*

- (a) Trunking should have covers secured by purpose-made rivets. Covers of the clip-on type is acceptable for trunking sizes up to 100 mm × 100 mm.
- (b) The trunking should be fixed and supported in the normal way by screws, but the holes in the trunking should be made oversize to allow for the movement of expansion. Washers should be used under the head of the screw which should not be tightened to its full extent.

25C **Installation of Cables**

(1) *General requirements*

- (a) All cables should be run in a vertical or horizontal direction, where practicable, and should be secured flat on the surface of walls, columns, partitions or ceilings, etc. throughout the entire route.

- (b) Where cables run as a span between beams, trusses, etc., rigid support throughout their entire length should be used. One of the fixing methods of cables hung under beams is illustrated in Figure 25(2).
- (c) Cables crossing an expansion joint should be formed into a loop such that any movement in the joint should not stress the cables.
- (d) For cables running on surface of walls or structures:
 - (i) buckle clip should only be used to fix cables having an overall diameter not exceeding 10 mm.
 - (ii) saddles and cleats may be used if the diameter of the cable exceeds 10 mm.
- (e)
 - (i) Cable saddles and cable cleats should be secured by fixing screws and should be provided along the entire cable route at regular intervals. The spacing between adjacent saddles or cleats should not exceed the values given in Table 25(3).
 - (ii) A saddle or cleat should also be provided at a distance not exceeding 150 mm from a termination and from both sides of a bend.
- (f) Where cables are installed under floors or within false ceilings, they should normally be supported and fixed throughout their lengths to the permanent ceiling or floor and provision should be made for access to the cable for inspection and maintenance. Such cables, if exposed to the risk of penetration by nails, screws and the like, should be protected by an earthed metallic sheath or enclosed in earthed steel conduit or trunking securely supported.
- (g) Where a wiring system passes through elements of building construction such as floor, walls, roofs, ceilings, partitions or cavity barriers, the openings remaining after passage of the wiring system shall be sealed according to the fire resistance requirements of BS 476:Part 20 or equivalent required of the element concerned (if any).
- (h) The internal bending radii of PVC insulated stranded copper cables should not be less than the values given below:

Overall Diameter of Cable, D	Minimum Internal Bending Radius	
	Non-armoured	Armoured
Not exceeding 10 mm	3D	6D
Exceeding 10 mm but not exceeding 25 mm	4D	6D
Exceeding 25 mm	6D	6D

- (i) Regarding the installation of high voltage cables, the manufacturer's recommendation should be referred.
- (2) *Installation of PVC insulated, PVC sheathed non-armoured cable*
- (a) Where protection is required for cables running up a wall from the floor, a metal channel cover should be fixed to a minimum height of 1.5 metres above finished floor level.
 - (b) Where cables pass through a building structure such as wall, column or floor slab, the cables should be drawn through PVC or G.I. sleeves inserted into the building structure as illustrated in Figure 25(3) and sealed up with proper fire resisting material of the same Fire Resisting Period according to the requirements of BS 476:Part 20 or equivalent.
 - (c) When cables are routed along or across steel joints, beams, stanchions, etc. they should be enclosed in steel or rigid PVC trunking/conduit.
 - (d) Rubber grommets or insulated bushes should be used to protect the non-armoured cables passing through metal box or any other metal work.
 - (e) Buckle clips should be:
 - (i) provided along the entire cable route at regular intervals not exceeding the spacing in Table 25(3);
 - (ii) provided at a distance not exceeding 75 mm from a termination and from both sides of a bend;
 - (iii) fixed and secured by pins with wall plug inserted to a minimum depth of 20 mm to the surface of wall, column, partition or ceiling. The head of every pin should be level with the surface of the clip so that no damage to the sheath of the fixed cables can occur; and every hole in the buckle clip should have a fixing pin.
 - (f) The neutral conductor of a twin core cable for a lighting final circuit should be looped through an insulated connector enclosed in the moulded box or pattress accommodating the switch.
- (3) *Installation of armoured or metallic sheathed cable*
- (a) Cables buried direct in ground should be armoured or metal sheathed. Cables of Category 1 & 3 should be buried at a depth not less than 450 mm and cables of Category 4 should be buried at a depth not less than 750 mm. They should be protected by means of cable cover tiles. The bottom of the cable trench should be first covered by a layer of sand or fine soil to a depth not less than the diameter of the cable before the cables are laid. Another layer of

sand or fine soil, to a depth of 100 mm over the cables, should then be provided before the cable tiles are laid to protect the cables throughout entire route.

- (b) Unless otherwise advised by the cable manufacturer, a tension releasing section should be provided for every 100 metres of vertical cable run.

(4) *Use of flexible cable and flexible cord*

- (a) Flexible cables or flexible cords for connections to portable appliances or equipment should have suitable length preferably between 1.5 m to 2 m.
- (b) Exposed lengths of flexible cable or flexible cord used for final connections to fixed equipment or appliance should be as short as possible.
- (c) Every non-flexible or flexible cable or flexible cord for use at low voltage shall comply with the appropriate recognised standard.
- (d) Where a flexible cord supports or partly supports a pendant luminaire, the maximum mass supported by the cord should not exceed the appropriate value indicated below, provided that the tension of the cord does not act directly on the termination to the wiring:

Nominal Cross-sectional Area of Conductor (mm ²)	Maximum Mass (kg)
0.5	2
0.75	3
1.0	5

25D **Cable Joint and Cable Termination**

(1) *Cable joint*

Cable joints of any type along cable runs in final circuits are not allowed. "Looping-in" wiring system should be used such that the cables or conductors are properly terminated at the junction box or equipment.

(2) *Boxes for cable joint and cable termination*

- (a) Boxes for the termination and for joining of cables may be of cast iron, or plastic shell with compound filled and of adequate size.
- (b) Where hot compound filling is used, the box should be warmed thoroughly before the compound is poured to allow total adhesion

between the compound and the box. The compound should then be allowed to cool and be topped up before the box is closed. No air pockets should be allowed to form inside the box.

- (c) Where cold compound with plastic shell is used, the complete jointing kit, including plastic shell, compound, insulating tape etc. should be from the same proprietary manufacturer. The jointing method and procedure as laid down by the manufacturer should be strictly adhered to.
- (d) Where the box is of cast iron, it should be fitted with suitable armouring clamps and glands; where the box is of plastic shell, it should be fitted with suitably sized armour bond.

(3) *General requirements for jointing and termination of cable*

- (a) All joints and terminations should have durable electrical continuity and adequate mechanical strength.
- (b) Ferrules, compression connectors and bare portions of cable core resulting from a jointing or terminating process should be insulated with an insulating tape or heat shrinkable tubing after completion the jointing or terminating process. Such insulating tape or heat shrinkable tubing should have equal or better electrical and mechanical properties than those of the original insulation removed, and should be adhered to the cores etc. securely and permanently. The final thickness should be in smooth contour throughout the whole length of the joint or termination.

(4) *Straight-through joint*

- (a) In a straight-through joint for copper conductors, the two conductors should be butted together after the strands have been soldered solid and should be jointed by means of a weak-back ferrule, soldered to the cores. Soldering should be carried out by pouring tinman's solder over the cores and the weak-back ferrule. In no circumstances should direct flame from a blow lamp be used for soldering.
- (b) Prior to making a soldered joint for aluminium conductors, each conductor should be cleaned by means of steel wool or similar abrasive and then tinned by pouring solder, especially made for use with aluminium, over the cores. Both cores should then be inserted in a weak-back aluminium ferrule which should be closed. The two aluminium cores to be jointed may be butted together. The soldering should be completed by pouring the solder over the ferrule, after applying a layer of flux recommended by the cable manufacturer for this purpose.

- (c) A compression joint should be made by inserting the conductor cores to be jointed into the opposite ends of a suitable type of compression jointing tube, which should have the correct size for the conductors. The tube should then be compressed onto the cores by means of a compressing tool. The tool used and the working procedure adopted should be as recommended by the compression joint or cable manufacturer.
 - (d) Where specialist jointing kits are used, the complete kit should be from the same manufacturer who specialises in manufacturing products for this purpose. The method and procedure adopted should be strictly in accordance with the manufacturer's recommendations.
- (5) *Jointing of protective conductors*
- (a) Protective conductors should be looped into earthing terminals of exposed conductive parts or extraneous conductive parts. Straight joints in protective conductors should be avoided as far as practicable. Tee-joints in protective conductors are acceptable.
 - (b) Tapes should be jointed by:
 - (i) double riveting, or
 - (ii) suitable tape clamps (when clamps are used, the tape clamps shall each be provided with at least 4 screws or bolts), or
 - (iii) means of exothermic or thermic welding utilizing the high temperature reaction of powdered copper oxide and aluminium, provided that the proper material and equipment are used in accordance with the manufacturer's recommended process, or
 - (iv) terminal block of suitable size.
- (6) *Joints and terminations of non-armoured cables*
- (a) Non-armoured cables terminated at a moulded box or pattress, a luminaire or other fittings should have the overall protective sheaths carried into the moulded box or pattress, luminaire or other fittings for a minimum distance of 13 mm.
 - (b) The circuit protective conductor should be terminated at the earthing terminal provided in the moulded box or pattress housing the wiring accessories.
 - (c) Where it is not required to terminate the circuit protective conductor in an accessory, the circuit protective conductor should be coiled away from the live terminals or any bare conductors and should be insulated and sleeved with a green-and-yellow PVC sleeve.

- (d) Jointing of circuit protective conductors of non-armoured cable should be in the same manner as jointing live conductors.

(7) *Jointing and termination of armoured cables*

- (a) Cable armours should be terminated at the armouring clamps and the inner sheath should pass through the gland.
- (b) Earth continuity across joints of a circuit protective conductor having adequate cross-sectional area and of same material as the phase conductors should be installed and connected to maintain the effectiveness of the earth continuity across every cable joint of the armoured cable.
- (c) PVC insulated armoured cables with copper or aluminium conductors should be terminated in a gland fitted with an armour clamp. Provision should be made to enable a watertight seal between the gland and inner PVC sheath. The gland body should be provided with an internal conical seating to receive the armour clamping cone and a clamping nut which should secure the armour clamping cone firmly to the armour wires ensuring that the armour wires are tightly clamped between the armour cone and conical armour seating. The spigot on the gland body should be threaded to suit standard conduit accessories. A PVC shroud should be fitted to cover the body of the gland and the exposed armour wires.
- (d)
 - (i) Terminating gland and armour clamp for cables with aluminium conductors should be made from aluminium. Cores should be terminated in a hot tinned brass or copper lug, which should be shaped to suit the sector shape of the conductor. The core should be tinned, and then soldered into the lug. Alternatively a compression termination may be used. In such cases, the cores should be inserted into the sleeve of an aluminium compression type cable lug. The sleeve should then be compressed onto the cores by means of a compressing tool. The tool used and the working procedure adopted should be as recommended by the cable manufacturer.
 - (ii) Prior to connection to the terminal, the cable lug should be painted with an anti-oxidising paste. The anti-oxidising paste should be suitable for preventing electrolytic action due to contact between the aluminium lug and copper or brass terminal, for an indefinite period. Alternatively, copper/aluminium bimetal cable lugs may be used.

(8) *Termination of bonding conductors*

- (a)
 - (i) A purpose-designed copper connector clamp should be used to bond the main equipotential bonding conductor to extraneous conductive parts of the non-electrical services, and should be

used to bond supplementary bonding conductors to exposed conductive parts or extraneous conductive parts.

- (ii) All contact surfaces should be clean and free from non-conducting materials, such as grease or paint, before the connector clamp is installed.
- (b) For steel surface conduit installations, the supplementary bonding conductors should be terminated at the nearest conduit or conduit box forming an integral part of the conduit installation.
- (c) (i) For concealed steel conduit installations, the supplementary bonding conductors should be terminated at a copper earthing terminal fitted inside a metal box forming an integral part of the conduit installation. For access to the concealed conduit, an arrangement similar to a telephone cord outlet is acceptable.
 - (ii) The metal conduit box should be located as near as possible to the bonding position and the exposed part of the supplementary bonding conductor should be made as short as possible.

(9) *Joint and termination for high voltage cables*

Regarding the joint and cable termination for high voltage cables, the manufacturer's recommendation should be referred.

25E **Installation of Socket Outlets**

- (a) Wall-mounted socket outlets should be installed with a minimum clear height of 150 mm from floor and 75 mm from surface top measured from the bottom of the socket outlet.
- (b) Socket outlets installed on floor surface should be suitably protected from ingress of water and from mechanical damage.
- (c) Socket outlets for household or similar use should be of shuttered type.
- (d) A socket outlet should be installed as far away as practicable from water tap, gas tap or cooker in order to avoid danger.

Table 25(1)*Spacing of Supports for Conduits*

Conduit Size (mm)	Maximum Distance between Supports (Metres)					
	Rigid Steel		Rigid Plastic/PVC		Pliable	
	Horizontal	Vertical	Horizontal	Vertical	Horizontal	Vertical
Not exceeding 16	0.75	1.0	0.75	1.0	0.3	0.5
Exceeding 16 but not exceeding 25	1.75	2.0	1.5	1.75	0.4	0.6
Exceeding 25 but not exceeding 40	2.0	2.25	1.75	2.0	0.6	0.8
Exceeding 40	2.25	2.5	2.0	2.0	0.8	1.0

- Notes: (1) The spacings tabulated above assume that the conduit is not exposed to mechanical stress other than that due to the weight of the enclosed cables, the conduit and fittings.
- (2) The above figures do not apply to a conduit used for supporting luminaires or other equipment.

Table 25(2)*Spacing of Supports for Cable Trunking (Steel or Plastic or PVC)*

Cross-sectional Area of Trunking (mm ²)	Maximum Distance between Support (Metres)			
	Steel Trunking		Plastic/PVC Trunking	
	Horizontal	Vertical	Horizontal	Vertical
Exceeding 300 but not exceeding 700	0.75	1.0	0.5	0.5
Exceeding 700 but not exceeding 1 500	1.25	1.5	0.5	0.5
Exceeding 1 500 but not exceeding 2 500	1.75	2.0	1.25	1.25
Exceeding 2 500 but not exceeding 5 000	3.0	3.0	1.5	2.0
Exceeding 5 000	3.0	3.0	1.75	2.0

- Notes: (1) The spacings tabulated above assume that the trunking is not exposed to mechanical stress other than that due to the weight of the enclosed cables, the trunking and fittings.
- (2) The above figures do not apply to trunking which is used for supporting lighting fittings or other equipment.

Table 25(3)*Spacing of Supports for Cables in Accessible Positions*

Overall diameter of cable‡ (mm)	Maximum spacing of clips (Metres)					
	Non-armoured rubber, PVC or lead-sheathed cables		Armoured cables		Mineral insulated copper sheathed or aluminium sheathed cables	
	Horizontal†	Vertical†	Horizontal†	Vertical†	Horizontal†	Vertical†
Not exceeding 9	0.25	0.4	—	—	0.6	0.8
Exceeding 9 but not exceeding 15	0.3	0.4	0.35	0.45	0.9	1.2
Exceeding 15 but not exceeding 20	0.35	0.45	0.4	0.55	1.5	2.0
Exceeding 20 but not exceeding 40	0.4	0.55	0.45	0.6	—	—

NOTE— For the spacing of supports for cables of overall diameter exceeding 40 mm, and for single-core cables having conductors of cross-sectional area 300 mm² and larger, the manufacturer's recommendations should be applied.

‡ For flat cables taken as the measurement of the major axis.

† The spacings stated for horizontal runs may be applied also to runs at an angle of more than 30° from the vertical. For runs at an angle of 30° or less from the vertical, the vertical spacings are applicable.

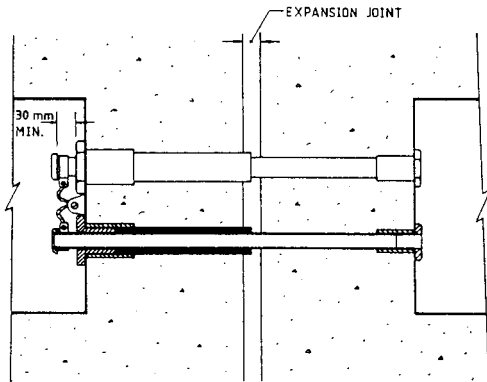
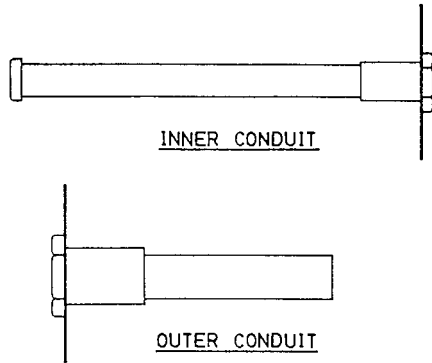

INSTALLATION OF CONDUIT CROSSING AN EXPANSION JOINT

CODE No.

25

FIGURE No.

25(1)

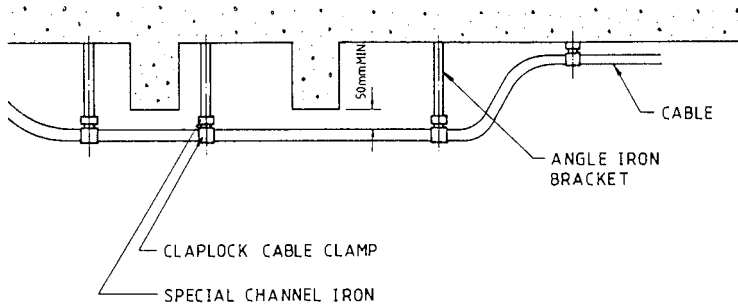

FIXING OF ARMoured CABLES HUNG UNDER BEAMS

CODE NO.

25

FIGURE No.

25(2)

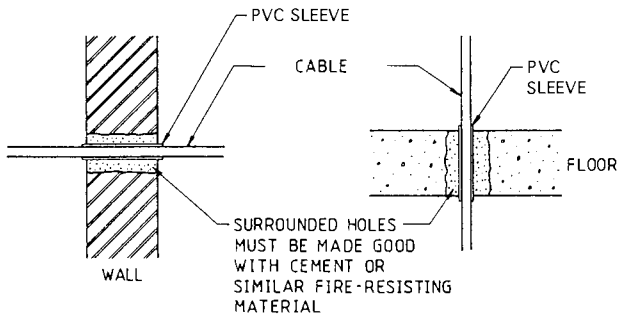
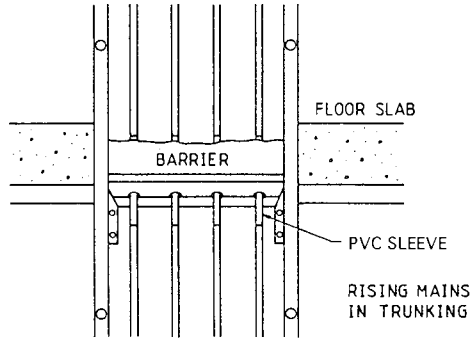

DETAILS OF CABLE PASSING THROUGH BUILDING STRUCTURE

CODE No.

25

FIGURE No.

25(3)

Code 26 REQUIREMENTS FOR SPECIFIC INSTALLATIONS AND EQUIPMENT

26A Domestic Installation and Appliance

- (1) Supply connection to domestic appliance
- (2) Electrical equipment in kitchens
- (3) Electrical equipment in bathrooms
- (4) Air-conditioners and space heaters
- (5) Water heaters
- (6) Electrical call bells and electric clocks

26B Busbar Trunking Distribution System

- (1) General
- (2) Busbar casing
- (3) Busbar
- (4) Expansion unit
- (5) Feeder unit
- (6) Tap-off unit
- (7) Busbar trunking accessories

26C Electric Motor

- (1) General
- (2) Rating of circuits supplying electric motors
- (3) Starting facilities of electric motors

26D Supply Connection to Transformers

26E Supply Connection to Welding Sets

26F Installation of Fluorescent and Gaseous Discharge Lamps

26G Installation of Category 3 Circuits

26H High Voltage Discharge Lighting Installation (Neon Signs)

- (1) Requirements of circuits
- (2) Means of isolation
- (3) Fireman's emergency switch
- (4) Installation
- (5) Transformers
- (6) Barrier for live parts
- (7) Earthing

- 26I Lightning Protection Installation
- 26J Rising Mains Installation
- 26K Temporary Supply Installation for Construction and Demolition Sites or Repair and Testing Purposes
 - (1) Scope
 - (2) General
 - (3) Design consideration
 - (4) Inspection, testing and maintenance
- 26L Hot Saunas Installation
 - (1) General
 - (2) Classification of zones
 - (3) Basic protection and fault protection
 - (4) Selection and erection of equipment
- 26M Swimming Pools and Fountains Installation
 - (1) General
 - (2) Assessment of general characteristics
 - (3) Bonding
 - (4) Application of protective measures against electric shock
 - (5) Selection and erection of equipment
- 26N Installation in Restrictive Conductive Locations
 - (1) Scope
 - (2) Basic protection and fault protection
 - (3) Basic protection
 - (4) Fault protection
- 26O Installation of Equipment Having High Earth Leakage Currents
- 26P Renewable Energy Power System
 - (1) Scope
 - (2) Selection and erection of installation
 - (3) Inspection, testing and maintenance
- 26Q Temporary Electrical Installation for Exhibitions, Shows, Stands and Festive Lighting
 - (1) Scope
 - (2) General
 - (3) Design consideration
- 26R Electric Heating Systems installed in Building Structures
- 26S Charging Facilities for Electric Vehicles

Code 26 REQUIREMENTS FOR SPECIFIC INSTALLATIONS AND EQUIPMENT

26A Domestic Installation and Appliance

(1) Supply connection to domestic appliance

- (a) For a single phase domestic appliance having a current rating exceeding 13A to be used in an installation where only 5A and/or 13A socket outlets are provided, or a domestic appliance having a current rating exceeding 15A to be used in an installation where only 5A and/or 15A socket outlets are provided, it should be connected permanently (i.e. not through a plug socket) to a separate radial final circuit and should be controlled by a double-pole switch in a readily accessible position near the appliance.
- (b) For supplying a single phase domestic appliance having a current rating not exceeding 13A, the use of a radial or ring final circuit using 13A socket outlets is acceptable.
- (c) For supplying a single phase domestic appliance having a current rating not exceeding 5A or 15A, the use of a radial final circuit using 5A or 15A socket outlet respectively, is acceptable.
- (d) Adequate number of socket outlets for supply connections to domestic appliances is to be provided for each individual household. Table 26(1) recommends the acceptable minimum number of socket outlets provided in various locations to afford the lowest quality of service.

(2) Electrical equipment in kitchens

- (a) For a circuit arrangement using 13A socket outlets to Code 6E, separate circuits should be used for supply to electrical equipment in kitchen other than luminaires.
- (b) Every cooking appliance having more than one boiling or cooking surfaces and with a total current rating exceeding 15A should be fed from an exclusive radial final circuit and controlled by a double-pole switch separate from the appliance and placed within 2 metres of the appliance.
- (c) Where two fixed or stationary cooking appliances are installed in one room of household premises, one switch may be used to control both appliances provided that neither appliance is placed more than 2 metres from the controlling switch.
- (d) The switch for the cooking appliance of subparagraphs (b) and (c) should be so positioned that the user does not have to lean across the appliance in order to operate it.

(3) *Electrical equipment in bathrooms*

- (a) Except for SELV, for a circuit supplying equipment in a room containing a fixed bath or shower, where the equipment is simultaneously accessible with exposed conductive parts of other equipment or with extraneous conductive parts, the characteristics of the protective devices and the earthing arrangements should be such that, in the event of a fault to earth, disconnection occurs within 0.4s. All circuits supplying electrical equipment with exposed conductive parts within 2.25m height above finished floor level should be protected by residual current device (RCD) with a residual operating current not exceeding 30mA.
- (b) Except for equipment supplied from a SELV circuit, in a room containing a fixed bath or shower, supplementary equipotential bonding to Code 11 should be provided between simultaneously accessible exposed conductive parts of equipment, between exposed conductive parts and simultaneously accessible extraneous conductive parts, and between simultaneously accessible extraneous conductive parts.

(Note: Where the bathroom is in a building with a protective equipotential bonding system in accordance with Code 11E, supplementary equipotential bonding may be omitted where all of the following conditions are met:

- (i) All final circuits of the bathroom comply with the requirements for automatic disconnection according to Code 11B;
 - (ii) All final circuits have additional protection by means of an RCD having the characteristics specified in Code 11J;
 - (iii) All extraneous conductive parts of the bathroom are effectively connected to the protective equipotential bonding according to Code 11E.)
- (c) Where electrical equipment is installed in the space below a bath, that space should be accessible only by the use of a tool and, in addition, the requirement of subparagraph (b) above should extend to the interior of that space.
 - (d) Every switch or other means of electrical control or adjustment should be so situated as to be normally inaccessible to a person using a fixed bath or shower. This requirement does not apply to:
 - (i) the insulating cords of cord-operated switches which comply with IEC 60669-1 or BS EN 60669-1 or equivalent;
 - (ii) mechanical actuators, with linkages incorporated insulating components, of remotely operated switches;

- (iii) controls and switches of water heaters and shower pumps which comply with the relevant requirements of appropriate recognised standards;
 - (iv) switches supplied by SELV at a nominal voltage not exceeding 12 V r.m.s. a.c. or d.c.;
 - (v) a shaver supply unit complying with subparagraph (e) below.
- (e) In a room containing a fixed bath or shower, provision for the connection of an electric shaver, toothbrush or similar light current appliance can be by means of a shaver supply unit complying with BS EN 61558-2-5 or such a unit incorporated in a luminaire (should be installed beyond Zone 2*). The earthing terminal of the shaver supply unit should be connected to the protective conductor of the final circuit from which the supply is derived.
 - (f) Surface wiring systems should not employ metallic conduit or metallic trunking or an exposed metallic cable sheath or an exposed earthing or bonding conductor.
 - (g) Lampholders within a distance of 2.5 metres from the bath or shower cubicle should be constructed of or shrouded in an insulating material.
 - (h) No stationary equipment having heating elements which can be touched should be installed within reach of a person using the bath or shower.
 - (i) No electrical installation or equipment should be installed in the interior of a bath tub or shower basin.
 - (j) In a room containing a fixed bath or shower, the provision of socket outlets should comply with IEC 60364-7-701 and be installed beyond Zone 2* (i.e. 0.6m away from shower basin or bath tub) and the socket outlets should be protected by an RCD with a residual operating current not exceeding 30mA. When a circuit designer who is a Registered Electrical Worker for Grade A, B or C considers it appropriate for the situations under consideration, additional safety measures may be used. These measures include the use of a dedicated circuit or a dedicated circuit protected by an isolating transformer.

* Zone dimensions in bathrooms should be referred to Figure 26(1)(a) and 26(1)(b)

(4) *Air-conditioners and space heaters*

- (a) Fixed air-conditioners and space heaters should be fed by separate radial final circuits controlled by a fuse or miniature circuit breaker at the distribution board.

- (b) Fixed air-conditioners and space heaters having a rating not exceeding 13A for a final circuit using 13A socket outlets or 15A for a final circuit using 15A socket outlets, may be connected via a plug and socket arrangement of adequate capacity. For this purpose, a switched socket outlet is to be used.
- (c) A fixed air-conditioner or a space heater having a rating exceeding that of subparagraph (b), should be connected to a terminal block adjacent to it and controlled by a double-pole switch.

(5) *Water heaters*

(a) *Electrode water heaters and boilers*

- (i) Every electrode boiler and electrode water heater should be connected to an a.c. system only, and should be selected and erected in accordance with the appropriate requirements of this CoP.
- (ii) The supply to the heater or boiler should be controlled by a linked circuit breaker arranged to disconnect the supply from all electrodes simultaneously and provided with an overcurrent protective device in each conductor feeding an electrode.
- (iii) The earthing of the heater or boiler shall comply with the requirements of Code 11 and, in addition, the shell of the heater or boiler should be bonded to the metallic sheath and armour, if any, of the incoming supply cable. The protective conductor should be connected to the shell of the heater or boiler and should comply with Code 11C(2).
- (iv) Where an electrode water heater or electrode boiler is directly connected to a supply at a voltage exceeding low voltage, the installation should include a residual current device arranged to disconnect the supply from the electrodes on the occurrence of a sustained earth leakage current in excess of 10% of the rated current of the heater or boiler under normal conditions of operation, except that if in any instance a higher value is essential to ensure stability of operation of the heater or boiler, the value may be increased to a maximum of 15%. A time delay may be incorporated in the device to prevent unnecessary operation in the event of imbalance of short duration.
- (v) Where an electrode water heater or electrode boiler is connected to a three phase low voltage supply, the shell of the heater or boiler should be connected to the neutral of the supply as well as to the earthing conductor. The current carrying capacity of the neutral conductor should be not less than that of the largest phase conductor connected to the equipment.

- (vi) Except as provided by (vii) where the supply to an electrode water heater or electrode boiler is single phase and one electrode is connected to a neutral conductor earthed by the electricity supplier, the shell of the water heater or boiler should be connected to the neutral of the supply as well as to the earthing conductor.
- (vii) Where the heater or boiler is not piped to a water supply or in physical contact with any earthed metal, and where the electrodes and the water in contact with the electrodes are so shielded in insulating material that they cannot be touched while the electrodes are live, a fuse in the phase conductor may be substituted for the circuit breaker required under (ii) and the shell of the heater or boiler need not be connected to the neutral of the supply.

(b) *Heaters for liquids or other substances, having immersed heating elements*

Every heater for liquid or other substance should incorporate or be provided with an automatic device to prevent a dangerous rise in temperature.

(c) *Water heaters having immersed and uninsulated heating elements*

- (i) Every single phase water heater or boiler having an uninsulated heating element immersed in the water should comply with the requirements of (ii) and (iii). This type of water heater or boiler is deemed not to be electrode water heater or boiler.
- (ii) All metal parts of the heater or boiler which are in contact with the water (other than current carrying parts) should be solidly and metallically connected to a metal water pipe through which the water supply to the heater or boiler is provided, and that water pipe should be connected to the main earthing terminal by means independent of the circuit protective conductor.
- (iii) The heater or boiler should be permanently connected to the electricity supply through a double-pole linked switch which is either separate from and within easy reach of the heater or boiler or is incorporated therein and the wiring from the heater or boiler should be directly connected to that switch without use of a plug and socket outlet; and, where the heater or boiler is installed in a room containing a fixed bath, the switch should also comply with Code 26A(3).
- (iv) Before a heater or boiler of the type referred to in subparagraph (c) is connected, the electrical worker should confirm that no single-pole switch, non-linked circuit breaker or fuse is fitted in the neutral conductor in any part of the circuit between the heater or boiler and the origin of the installation.

- (d) Single phase domestic thermal storage or instantaneous water heaters not exceeding 6 kilowatts should be connected to an individual final circuit and be controlled by a double-pole switch of adequate rating. If the water heater is installed in a bathroom, the double pole switch should be installed outside the bathroom in a convenient position.
 - (e) A thermal storage or instantaneous water heaters exceeding 30 ampere or having a current rating exceeding half of the maximum demand of an installation in any one phase, should be connected to a three phase supply except when approved by the electricity supplier.
- (6) *Electrical call bells and electric clocks*
- (a)
 - (i) Call bell transformers should be double wound.
 - (ii) Call bell transformers should be connected via a plug and socket arrangement or via a connection unit or cable coupler.
 - (iii) Call bell pushes should be wired to the secondary windings at an extra low voltage.
 - (b) Electric clocks may be connected to a lighting circuit via a connection unit or cable coupler provided that the current demand of the circuit does not exceed the rating of the overcurrent protective device.

26B **Busbar Trunking Distribution System**

(1) *General*

- (a) The busbar trunking system should comply with IEC 60439-2 / BS EN 60439-2 and should be properly supported.
- (b) The busbar trunking system must be suitable for branch circuit connections to the busbars by tap-off units or cable clamping devices.
- (c) The cross-sectional area of phase and neutral conductors of the busbars system should be selected taking into account the effects of harmonic current that may be present in the distribution system.

(2) *Busbar casing*

- (a) The casing of the busbar trunking system should be totally enclosed. It should be rigidly constructed from sheet steel galvanised or suitably protected against corrosion of not less than 1.2 mm thick for the width or height of the casing not exceeding 100 mm; and not less than 1.5 mm thick for a width or height exceeding 100 mm.

- (b) Facilities should be incorporated in the busbar casing to provide access to the busbars at regular intervals throughout the entire length. Removal of the cover for access facility should necessitate the use of tools.

(3) *Busbar*

- (a) For busbar installation having a rated capacity not exceeding 400 amperes in each phase of a 3-phase 4-wire system, the associated neutral busbars should have a cross-sectional area not less than the cross-sectional area of the phase busbar.
- (b) For busbar installation having a rated capacity exceeding 400A in each phase of a 3-phase 4-wire system, the associated neutral busbar may have a cross-sectional area smaller than the cross sectional area of the phase busbar if overcurrent detection is provided for the neutral conductor, which is appropriate to the cross-sectional area of the conductor. This detection shall cause the disconnection of the phase conductors but not necessarily the neutral conductor.
- (c) The joint part of the busbar, or contact part of the busbars in the case of plug-in busbar trunking systems, should be electroplated with tin or other equivalent materials.
- (d) Drilling of all-insulated busbars for connection of cables are not acceptable.

(4) *Expansion unit*

Proper expansion unit should be provided where:

- (a) both ends of the busbar trunking system are fixed, or
- (b) the busbar trunking system is installed across a building expansion joint, or
- (c) the run of busbar exceeds 30 metres or as recommended by the busbar manufacturer.

(5) *Feeder unit*

A proper feeder unit should be provided for each busbar trunking system for connection of incoming supply.

(6) *Tap-off unit*

- (a) Proper tap-off unit should be used where a branch circuit is taken off from the busbars.

- (b) Where protective devices are used separately for tapping-off, they should be provided adjacent to the tapping position for protection of the branch circuits.
 - (c) Where conductors are used for connection to the busbars, they should have a current rating not less than that of the tap-off units.
 - (d) Where plug-in tap-off units are used, mechanical interlocks should be provided such that the tap-off unit cannot be inserted or removed from the busbar trunking unless it is in the 'OFF' position.
 - (e) Where cutout fuses are used for tap-off supply from busbars, they should be equipped with an insulated carrier to avoid danger during replacement of withdrawal.
- (7) *Busbar trunking accessories*
- (a) Accessories such as bends, tees, feeder and tap-off units for busbar trunking system should be purpose-made.
 - (b) Bends, tees and intersection units should be designed and manufactured to suit the particular type of busbar system. The casing should have a cross-sectional area not less than that of the busbar casing.

26C **Electric Motor**

- (1) *General*
- (a) Every electrical motor having a rating exceeding 0.37 kW should be provided with control equipment incorporating means of protection against overload in the motor.
 - (b) This requirement does not apply to motors incorporated in an item of current using equipment complying as a whole with an appropriate recognised standard.
- (2) *Rating of circuits supplying electric motors*
- (a) All equipment, including cable of every electrical part of the circuit carrying the starting, accelerating and load currents of a motor should be suitable for a current at least equal to the full load current rating of the motor. Where the motor is intended for intermittent duty and for frequent stopping and starting, account should be taken of any cumulative effects of the starting or braking currents upon the temperature rise of the equipment of the circuit.
 - (b) The rating of the circuit supplying a slip ring or a commutator induction motor should be suitable for the starting and load conditions of the motor.

(3) *Starting facilities of electric motors*

- (a) The starting facilities of induction motors of various sizes should restrict the starting current of the motors to maximum acceptable limits as required by the electricity supplier.
- (i) Low voltage induction motors
- (A) The choice of motor size and maximum acceptable starting current should be in accordance with the following table:

Supply Arrangement	Motor Size (M) in Kilowatts	No. of Phases	Maximum Starting Current (in Multiple of Full Load Current)
From Electricity Supplier's Overhead Line System	$M \leq 1.5$	1-phase	6
	$1.5 < M < 3.8$	3-phase	6
	$3.8 \leq M \leq 11$	3-phase	2.5
From Electricity Supplier's Non-overhead Line System	$M \leq 2.2$	1-phase	6
	$2.2 < M < 11$	3-phase	6
	$11 \leq M \leq 55$	3-phase	2.5

- (B) Motors exceeding the limits stipulated in the table above must be approved in writing by the electricity supplier.
- (ii) Synchronous motors and high voltage motors should only be installed by special arrangement with the electricity supplier.
- (b) Except where failure to start after a brief interruption would be likely to cause greater danger, motors should be provided with means to prevent automatic restarting after the stoppage due to drop in voltage or failure of supply, where unexpected restarting of the motor might cause danger. These requirements do not preclude arrangements for starting a motor at intervals by an automatic control device, where other adequate precautions are taken against danger from unexpected restarting.

26D **Supply Connection to Transformers**

- (a) Where an autotransformer is connected to a circuit having a neutral conductor, the common terminal of the winding should be connected to the neutral conductor.
- (b) Where a step-up transformer is used, a linked switch should be provided for disconnecting the transformer from all live conductors (i.e. phase and neutral conductors) of the supply.

26E **Supply Connection to Welding Sets**

Welding sets having a current rating exceeding 30A single phase or half of the maximum demand of an installation in any one phase should be permanently connected to the mains on a 3-phase supply. Exposed conductive parts of welding sets must be effectively connected to earth.

26F **Installation of Fluorescent and Gaseous Discharge Lamps**

- (a) Capacitors and chokes should normally be fitted inside the luminaire. Where they are fitted separately, they should be mounted in a metal box. Precautions should be taken to prevent the components from overheating, e.g. by the provision of adequate ventilation.
- (b) The type and size of cables should be properly selected with due regard to the ambient temperature, the inrush current and high voltages generated during starting. The neutral conductor in every discharge lamp circuit should have a cross-sectional area not less than that of the phase conductor.

26G **Installation of Category 3 Circuits**

Electrical installation of Category 3 circuits should comply with the requirements of the relevant authority in respect to fire protection aspects.

26H **High Voltage Discharge Lighting Installation (Neon Signs)**

- (1) *Requirements of circuits*
 - (a) High voltage discharge lighting installation should *not* be connected to the electricity supply through a plug and socket arrangement.
 - (b) Circuits should be capable of carrying the total steady load current of the lamps, any associated gear and also their harmonic currents.
 - (c) Where exact information on the associated gear is not available, the product of the rated wattage of the associated gear and a multiplying factor of not less than 1.8 shall be taken as the demand of the installation in volt-amperes.
 - (d) The cross-sectional area of the neutral conductor in every discharge lighting circuit should not be less than that of the phase conductor.
 - (e) Every switch for a discharge lighting circuit should be identified with a permanent label and should have a normal current rating not less

than the product of the total steady current which it is required to carry and a multiplying factor of 1.8.

(2) *Means of isolation*

One or more of the following means should be provided inside the building for the isolation from all live conductors of the supply to self-contained luminaires or every circuit supplying high voltage luminaires, and such means should comply with requirements of Code 8B(2):

- (a) an interlock on the self-contained luminaire, so arranged that before access can be made to live parts, the supply is automatically disconnected, such means being additional to the switch normally used for controlling the circuit, or
- (b) a switch having a lock or removable handle, or a distribution board which can be locked, and with such arrangements to prevent the restoration of the supply by unauthorised persons. Where an installation comprises more than one such switch or distribution board, all keys and removable handles should be non-interchangeable.

(3) *Fireman's emergency switch*

A fireman's emergency switch complying with requirements of Code 8B(4), should be provided for every exterior or interior high voltage lighting installation which is operated unattended. Such firemen's emergency switch should:

- (a) be arranged to isolate the installation from all live conductors of the supply, except that it need not isolate the neutral conductor of a 3-phase 4-wire supply;
- (b) be fixed in a conspicuous position, reasonably accessible to firemen at not less than 2.7 metres and not more than 3.0 metres above the floor or the ground;
- (c) be clearly marked to indicate the installation or part of the installation which they control, where more than one fireman's switch is installed in any one building;
- (d) preferably be provided with a catch so designed as to prevent the switch being inadvertently or accidentally returned to the 'ON' position;
- (e) for exterior installation, be outside the building and as near as possible vertically below the electrical discharge lamp(s). Alternatively a notice indicating the position of the switch shall be placed directly below the electrical discharge lamp(s) and a nameplate should be fixed near the switch so as to render it clearly distinguishable. An installation in a closed market or in an arcade is deemed to be an

exterior installation and a temporary installation in a permanent building used for exhibitions is considered as an interior installation and not an exterior installation.

- (f) for interior installations, be near the main entrance to the building or alternatively in a position to be agreed with the electricity supplier and the Fire Services Department.

(4) *Installation*

- (a) The luminous discharge tubes should be substantially supported at a sufficient distance from the sign face to ensure no arcing from the tube to any other portion of the sign could occur under normal condition, and be so installed as to be free from contact with inflammable material except that rubber glands are permitted where a weather proof construction is desirable.
- (b) Tubes should not be unduly exposed to mechanical damage.
- (c) Ancillary equipment for high voltage installations including inductors, capacitors, resistors and transformers should either be totally enclosed in a rigid and effectively earthed metal container (which may form part of the luminaires), or alternatively should be placed in a suitably ventilated enclosure of incombustible material or of fire resisting construction.
- (d) High voltage cables and conductors should be supported at intervals not exceeding the appropriate values stated in the following table. Support for insulated-and-braided cables and for bare conductors should be of non-ignitable, non-hygroscopic insulating material, e.g. glass or glazed porcelain.

Type of Cable or Conductor	Spacing of Supports	
	Horizontal (mm)	Vertical (mm)
Bare conductor	500	500
Insulated-and-braided cables	500	800
Metal sheathed, non-armoured cables	800	1 250
Armoured cables	1 000	1 500

- (e) Every inductor and high reactance transformer should be installed as near as practicable to its associated electric discharge tube.
- (f) The transformer, discharge tube and other parts of high voltage circuits should be located out of reach.

(5) *Transformers*

- (a) Every transformer should be double wound with windings insulated with material to a minimum quality of class E insulation and tropicalised.
- (b) One point of the secondary winding of every transformer should be connected to an earthing terminal on the body of the container.
- (c) The secondary voltage of every transformer should not exceed 5 kV r.m.s. to earth on open circuit.
- (d) Every high voltage circuit supplied from a transformer having a rated input exceeding 500 watts should be provided with means for automatic disconnection of the supply at the supply end of the transformer in the event of a fault current exceeding 20 percent of the normal steady current in the circuit.
- (e) The rating plate of every transformer should carry:
 - (i) the maker's name,
 - (ii) open-circuit secondary voltage,
 - (iii) rated secondary current,
 - (iv) rated primary voltage, and
 - (v) rated primary current.

(6) *Barrier for live parts*

- (a) All live parts, including all conductors but excluding the tubes except in the neighbourhood of their terminals, should be provided with effective barriers of earthed metal or insulating materials, or mechanical strength adequate to withstand the conditions of normal service, or alternatively, for installations on the exterior of a building, such live parts may be so situated as to be accessible only to responsible persons.
- (b) Barriers made of insulating material used for this purpose should be non-hygroscopic, anti-tracking and substantially non-ignitable. Glass barriers may be used only if so situated as to be accessible only to responsible persons.

(7) *Earthing*

Exposed conductive parts and metalwork inclusive of metal frames of high voltage discharge lighting signs, as well as sheaths of cables should be permanently connected to protective conductors and effectively earthed.

26I **Lightning Protection Installation**

Lightning protection installations should be installed to IEC 62305, BS EN 62305, AS/NZS 1768, NFPA 780 or equivalent.

26J **Rising Mains Installation**

- (a) Any building of more than four floors including the ground floor should be provided with 3-phase electrical rising mains with a 3-phase 4-wire tee-off at each floor unless otherwise agreed by the electricity supplier.
- (b) The design of the rising mains installation should be agreed by the electricity supplier.
- (c) Separate riser earthing conductors should be provided to earth all units therein. The minimum cross-sectional area of riser earthing conductor should be 70 mm² for copper and 150 mm² for aluminium.
- (d) The consumer's main connection between the electricity supplier's meter and the consumer's main switch should be installed and maintained by the consumer and should be not less than 4 mm² stranded copper conductors.
- (e) In multi-consumer premises a device capable of both isolating and switching the full load current of the whole installation should be provided for each consumer at a position immediately before the electricity supplier's meter. For a single phase installation this device should be of double-pole type interrupting all live conductors.
- (f) In multi-consumer premises no part of the communal installation should pass through any individual consumer's unit within the building.

26K **Temporary Supply Installation for Construction and Demolition Sites or Repair and Testing Purposes**

(1) *Scope*

The particular requirements of this Code should apply to temporary installation providing supplies during the execution of construction or demolition works, or for repair and testing purposes. This type of installation should not be used as permanent supply.

(2) *General*

- (a) This type of installation should comply with the requirement of the Wiring Regulations.

- (b) Electrical apparatus and wiring installations in construction sites may be subjected to extreme abuse and the equipment to be used should withstand the particularly adverse conditions. Correct installation of overhead line or underground cable system, circuit protection, earthing arrangement will be essential as well as frequent inspection and testing to such installations.

(3) *Design consideration*

(a) *Operating voltage*

(i) *Mains voltage*

- Three phase, low voltage - 380 V 4-wire is the standard three phase mains supply voltage.
- Single phase, low voltage - 220 V 2-wire is the standard single phase mains supply voltage.
- Three phase, high voltage - Please consult the power companies regarding their standard three phase mains supply voltage.

(ii) *Lighting accessible to public*

Road work and site lighting which is connected to mains supply system and accessible to general public should be operated at 110 volts obtained by use of an isolating transformer having the centre tap of the secondary winding earthed so that the normal voltage of circuit to earth does not exceed 55 volts.

(b) *Selection and erection of installation*

(i) *Cable circuits*

Where risk of mechanical damage is slight, the installation can be carried out in PVC insulated cable. However where damage is likely to occur armoured cables should be used. All cables that are likely to be frequently moved in normal use should be flexible cables.

All cables shall be suitably supported and properly fixed.

(ii) *Overhead line circuits*

Where carrier wire is used to support cable suspended between poles, Codes 16H and 16I should be complied with.

Cables crossing carriage ways should be supported by steel poles of suitable construction to withstand wind of typhoon force. Wooden supports of adequate strength will be permitted in other locations.

- (iii) Minimum clearance between ground and line should comply with Code 16E(2).

- (iv) Where steel poles are used, installation methods shall comply with Codes 16B and 16I.

- (v) Where wooden poles are used, all stay wires should be insulated to prevent danger from leakage. A stay insulator placed at a height not less than 3.1 m from ground should be installed.
- (c) *Protection of circuits*
- (i) Protection apparatus with adequate interrupting capability should be provided for all main and sub-circuits against overcurrent and earth faults.
 - (ii) Discrimination between protection devices of main and sub-circuits should be allowed where necessary.
- (d) *Protection against earth leakage*
- (i) This type of installation should be provided with a Residual Current Device (RCD) at main intake position to afford protection against earth leakage.
 - (ii) The operating current of the RCD to be used should be such that when its value in amperes is multiplied by the earth fault loop impedance in ohms, the product does not exceed 25 volts.
 - (iii) Circuits supplying socket outlet should be protected by RCD having a rated residual operating current not exceeding 30 mA.
 - (iv) An earthing conductor should connect the consumer's main earthing terminal to an effective earth electrode. The size of the earthing conductor should be in accordance with Code 11H.
 - (v) In addition to the item (iv), the consumer should provide a bond between electricity supplier's metal sheath cable and consumer's main earthing terminal. The size of bonding conductor should be in accordance with Code 11G(b).
- (e) *Precaution against danger*
- (i) All equipment and cables exposed to weather, corrosive atmosphere or damp conditions should be of the weather proof type or contained in weather proof enclosures suitable for the conditions.
 - (ii) Socket outlets, plugs and cable couplers should comply with IEC 60309-2 with the colour identification coding as follows:
 - 380/415 V, 50/60 Hz — Red;
 - 220/250 V, 50/60 Hz — Blue;
 - 110/130 V, 50/60 Hz — Yellow.
 - (iii) Lampholders should be of the all-insulated pattern and capable of withstanding rough usage. Handlamps must be made of insulated material with bulbs efficiently guarded against breakage.

(f) *Supply from generator set*

Where the electricity supply is obtained from a generator set, the TN-S earthing system should be used.

(4) *Inspection, testing and maintenance*

An owner of the temporary installation should ensure that the electrical equipment and apparatus are maintained in a safe and proper working condition at all times.

A registered electrical worker should be appointed to be responsible for the safety and any alteration or extension of the installation. The name, designation and contact telephone number of such person should be permanently displayed close to the main switch of the installation.

A separate log book recording regular checks, maintenance, repair, extension and alteration should be provided for inspection by the Director and the electricity supplier.

26L **Hot Air Saunas Installation**

(1) *General*

The particular requirements of this Code should apply to:

- (a) sauna cabins erected on site, e.g. in a location or in a room;
- (b) the room where the sauna heater is, or the sauna heating appliances are installed. In this case the whole room is considered as the sauna.

The requirements of this Code do not apply to prefabricated sauna cabins complying with a relevant equipment standard.

(2) *Classification of zones*

The zones specified below should be taken into account (see Figure 26(2)):

- (a) Zone 1 is the volume containing the sauna heater, limited by the floor, the cold side of the thermal insulation of the ceiling and a vertical surface circumscribing the sauna heater at a distance 0.5m from the surface of the heater. If the sauna heater is located closer than 0.5m to a wall, then Zone 1 is limited by the cold side of the thermal insulation of that wall.
- (b) Zone 2 is the volume outside Zone 1, limited by the floor, the cold side of the thermal insulation of the walls and a horizontal surface located 1.0m above the floor.

- (c) Zone 3 is the volume outside Zone 1, limited by the cold side of the thermal insulation of the ceiling and walls and a horizontal surface located 1.0m above the floor.

(3) *Basic protection and fault protection*

- (a) The protective measures of obstacles and placing out of reach are not permitted.
- (b) The protective measures of non-conducting locations and earth-free local equipotential bonding are not permitted.
- (c) Additional protection should be provided for all circuits of the sauna, by the use of one or more RCDs having the characteristics specified in Code 11J. RCD protection need not be provided for the sauna heater unless such protection is recommended by the manufacturer.
- (d) Where SELV or PELV is used, whatever the nominal voltage, basic protection should be provided by:
 - (i) basic insulation of live parts such that they are completely covered with insulation which can only be removed by destruction, or
 - (ii) barriers or enclosures affording a degree of protection of at least IPXXB or IP2X.

(4) *Selection and erection of equipment*

- (a) All equipment should have at least the degree of protection of IPX4. If cleaning by use of water jets may be reasonably expected, electrical equipment should have a degree of protection of at least IPX5.
- (b) In Zone 1, only the sauna heater and equipment belonging to the sauna heater should be installed.

In Zone 2, there is no special requirement concerning heat resistance of equipment.

In Zone 3, equipment should withstand a minimum temperature of 125°C and the insulation and sheaths of cables should withstand a minimum temperature of 170°C.
- (c) The wiring system should be preferably installed outside the zones, i.e. on the cold side of the thermal insulation. If the wiring system is installed on the warm side of the thermal insulation in Zones 1 or 3, it should be heat-resisting. Metallic sheaths and metallic conduits should not be accessible in normal use.
- (d) Switchgear and controlgear which forms part of the sauna heater equipment or of other fixed equipment installed in Zone 2 may be installed within the sauna room or cabin in accordance with the

manufacturer's instructions. Other switchgear and controlgear, e.g. for lighting, should be placed outside the sauna room or cabin. Socket outlets should not be installed within the sauna room or cabin.

- (e) Sauna heating appliances should comply with BS EN 60335-2-53 and be installed in accordance with the manufacturer's instructions.

26M **Swimming Pools and Fountains Installation**

(1) *General*

The particular requirements of this Code should apply to the basins of swimming pools, the basins of fountains and the basins of paddling pools and their surrounding zones where, in normal use, the risk of electric shock is increased by a reduction in body resistance and contact of the body with earth potential.

Special requirements may be necessary for swimming pools for medical purposes.

(2) *Assessment of general characteristics*

Figures 26(3), 26(4), 26(5) and 26(6) illustrate the zone dimensions of swimming pools/fountains/paddling pools.

Zone 0 is the interior of the basin of the swimming pool or fountain including any recesses in its walls or floors, basins for foot cleaning and waterjets or waterfalls and the space below them.

Zone 1 is limited by:

- (a) Zone 0,
- (b) a vertical plane 2 m from the rim of the basin,
- (c) the floor or surface expected to be occupied by persons, and
- (d) the horizontal plane 2.5 m above the floor or the surface expected to be occupied by persons.

Where the swimming pool or fountain contains diving boards, spring boards, starting blocks, chutes or other components expected to be occupied by persons, Zone 1 comprises the zone limited by:

- (a) a vertical plane situated 1.5 m from the periphery of the diving boards, spring boards, starting blocks, chutes and other components such as accessible sculptures, viewing bays and decorative basins, and
- (b) the horizontal plane 2.5 m above the highest surface expected to be occupied by persons.

Zone 2 is limited by:

- (a) the vertical plane external to Zone 1 and a parallel plane 1.5 m from the former,
- (b) the floor or surface expected to be occupied by persons, and
- (c) the horizontal plane 2.5 m above the floor or surface expected to be occupied by persons.

There is no Zone 2 for fountains.

(3) *Bonding*

All extraneous conductive parts in Zones 0, 1 and 2 should be connected by supplementary equipotential bonding conductors to the protective conductors of exposed conductive parts of equipment situated in these Zones.

(4) *Application of protective measures against electric shock*

- (a) Except for fountains as stated in Code 26M(6), in Zone 0 only protection by SELV at a nominal voltage not exceeding 12V a.c. r.m.s. or 30V ripple-free d.c. is permitted, the source for SELV being installed outside Zones 0, 1 and 2.
- (b) Except for fountains as stated in Code 26M(6), in Zone 1 only protection by SELV at a nominal voltage not exceeding 25V a.c. r.m.s. or 60V ripple-free d.c. is permitted, the source for SELV being installed outside Zones 0, 1 and 2.
- (c) Equipment for use in the interior of basins which is only intended to be in operation when people are not inside Zone 0 should be supplied by a circuit protected by:
 - SELV, the source for SELV being installed outside Zones 0, 1 and 2. However, it is permitted to install the source for SELV in Zone 2 if its supply circuit is protected by an RCD having the characteristics specified in Code 11J, or
 - automatic disconnection of supply, using an RCD having the characteristics specified in Code 11J, or
 - electrical separation, the source for electrical separation supplying only one item of current using equipment and being installed outside Zones 0, 1 and 2. However, it is permitted to install the source in Zone 2 if its supply circuit is protected by an RCD having the characteristics specified in Code 11J.
- (d) In Zone 2, one or more of the following protective measures should be employed:

- SELV, the source for SELV being installed outside Zones 0, 1 and 2. However, it is permitted to install the source for SELV in Zone 2 if its supply circuit is protected by an RCD having the characteristics specified in Code 11J;
- Automatic disconnection of supply, using an RCD having the characteristics specified in Code 11J;
- Electrical separation, the source for electrical separation supplying only one item of current using equipment and being installed outside Zones 0, 1 and 2. However, it is permitted to install the source in Zone 2 if its supply circuit is protected by an RCD having the characteristics specified in Code 11J.

(5) *Selection and erection of equipment*

(a) *Degree of protection of enclosures*

Equipment should have the following minimum degrees of protection or equivalent:

- (i) in Zone 0 – IPX8
- (ii) in Zone 1 – IPX4
 - IPX5 where water jets are likely to occur for cleaning purposes
- (iii) in Zone 2 – IPX2 for indoor locations
 - IPX4 for outdoor locations
 - IPX5 where water jets are likely to occur for cleaning purposes.

(b) *Wiring systems*

- (i) In Zones 0, 1 and 2, any metallic sheath or metallic covering of a wiring system should be connected to the supplementary equipotential bonding. Cables should preferably be installed in conduits made of insulating material.
- (ii) In Zones 0 and 1, a wiring system should be limited to that necessary to supply equipment situated in these Zones.
- (iii) Junction box should not be installed in Zones 0 and 1, but in case of SELV circuits it is permitted to install junction boxes in Zone 1.

(c) *Switchgear and controlgear*

- (i) In Zones 0 and 1, switchgear or controlgear should not be installed.
- (ii) In Zones 0 or 1, a socket outlet should not be installed.
- (iii) In Zone 2, a socket outlet or a switch is permitted only if the supply circuit is protected by one of the following protective measures:

- SELV, the source of SELV being installed outside Zones 0, 1 and 2. However, it is permitted to install the source of SELV in Zone 2 if its supply circuit is protected by a RCD having the characteristics specified in Code 11J;
 - Automatic disconnection of supply, using an RCD having the characteristics specified in Code 11J;
 - Electrical separation, the source for electrical separation supplying only one item of current using equipment, or one socket outlet, and being installed outside Zones 0, 1 and 2. However, it is permitted to install the source in Zone 2 if its supply circuit is protected by an RCD having the characteristics specified in Code 11J.
- (iv) For a swimming pool where it is not possible to locate a socket outlet or switch outside Zone 1, a socket outlet or switch, preferably having a non-conductive cover or coverplate, is permitted in Zone 1 if it is installed outside (1.25 m) from the border of Zone 0, is placed at least 0.3 m above the floor, and is protected by:
- SELV, at a nominal voltage not exceeding 25V a.c. r.m.s. or 60V ripple-free d.c., the source for SELV being installed outside Zones 0 and 1, or
 - automatic disconnection of supply, using an RCD having the characteristics specified in Code 11J, or
 - electrical separation for a supply to only one item of current using equipment, the source for electrical separation being installed outside Zones 0 and 1.
- (d) *Other equipment*
- (i) In Zones 0 and 1, it is only permitted to install fixed current using equipment specifically designed for use in a swimming pool.
- (ii) Equipment which is intended to be in operation only when people are outside Zone 0 may be used in all zones provided that it is supplied by a circuit protected according to subparagraph (4) above.
- (iii) It is permitted to install an electric heating unit embedded in the floor, provided that it:
- is protected by SELV, the source of SELV being installed outside Zones 0, 1 and 2. However, it is permitted to install the source of SELV in Zone 2 if its supply circuit is protected by an RCD having the characteristics specified in Code 11J, or
 - incorporates an earthed metallic sheath connected to the supplementary equipotential bonding specified in subparagraph (3) above and its supply circuit is additionally

protected by an RCD having the characteristics specified in Code 11J, or

- is covered by an embedded earthed metallic grid connected to the supplementary equipotential bonding specified in subparagraph (3) above and its supply circuit is additionally protected by an RCD having the characteristics specified in Code 11J.
- (iv) A luminaire for use in the water or in contact with the water should be fixed and comply with BS EN 60598-2-18. Underwater lighting located behind watertight portholes, and serviced from behind, should comply with the appropriate part of BS EN 60598 and be installed in such a way that no intentional or unintentional conductive connection between any exposed conductive part of the underwater luminaires and any conductive parts of the portholes can occur.
- (v) Fixed equipment designed for use in swimming pools and other basins (e.g. filtration systems, jet stream pumps) and supplied at low voltage is permitted in Zone 1, subject to all the following requirements being met:
- The equipment should be located inside an insulating enclosure providing at least Class II or equivalent insulation and providing protection against mechanical impact of medium severity (AG2);
 - The equipment should be accessible only via a hatch (or a door) by means of a key or a tool. The opening of the hatch (or door) should disconnect all live conductors. The supply cable and the main disconnecting means should be installed in a way which provides protection of Class II or equivalent insulation;
 - The supply circuit of the equipment should be protected by SELV at a nominal voltage not exceeding 25V a.c. r.m.s. or 60V ripple-free d.c., the source of SELV being installed outside Zones 0, 1 and 2, or an RCD having the characteristics specified in Code 11J, or electrical separation, the source for electrical separation supplying a single fixed item of current using equipment and being installed outside Zones 0, 1 and 2.
- (vi) For swimming pools where there is no Zone 2, lighting equipment supplied by other than a SELV source at 12V a.c. r.m.s. or 30V ripple-free d.c. may be installed in Zone 1 on a wall or on a ceiling, provided that the following requirements are fulfilled:
- The circuit is protected by automatic disconnection of the supply and additional protection is provided by an RCD having the characteristics specified in Code 11J;

- The height from the floor is at least 2m above the lower limit of Zone 1.
- (vii) In addition, every luminaire should have an enclosure providing Class II or equivalent insulation and providing protection against mechanical impact of medium severity.

(6) *Fountains*

- (a) In Zones 0 and 1 of fountains, one or more of the following protective measures should be employed:
- (i) SELV, the source for SELV being installed outside Zones 0 and 1;
 - (ii) Automatic disconnection of supply, using an RCD having the characteristics specified in Code 11J;
 - (iii) Electrical separation, the source for electrical separation supplying only one item of current using equipment and being installed outside Zones 0 and 1.
- (b) For a fountain, the following additional requirements should be met:
- (i) A cable for electrical equipment in Zone 0 should be installed as far outside the basin rim as is reasonably practicable and run to the electrical equipment inside Zone 0 by the shortest practicable route;
 - (ii) In Zone 1, a cable should be selected, installed and provided with mechanical protection to medium severity (AG2) and the relevant submersion in water depth (AD8). The cable type to BS 7919 is suitable up to a depth of 10m of water. For depths of water greater than 10m the cable manufacturer should be consulted;
 - (iii) Electrical equipment in Zones 0 or 1 should be provided with mechanical protection to medium severity (AG2), e.g. by use of mesh glass or by grids which can only be removed by the use of a tool;
 - (iv) A luminaire installed in Zones 0 or 1 should be fixed and should comply with BS EN 60598-2-18.
 - (v) An electric pump should comply with the requirements of BS EN 60335-2-41.

26N **Installation in Restrictive Conductive Locations**

(1) *Scope*

The particular requirements of this Code should apply to installations within or intended to supply equipment or appliances to be used within a Restrictive Conductive Location. They do not apply to any location in which freedom of movement is not physically constrained.

(2) *Basic protection and fault protection*

Where protection by the use of SELV or functional extra low voltage (FELV) is used, the voltage should not exceed 25V a.c., r.m.s. or 60V ripple free d.c. and, regardless of the voltage, basic protection should be provided by:

- (a) a barrier or enclosure affording at least the degree of protection IP2X or IPXXB or equivalent, or
- (b) insulation capable of withstanding a test voltage of 500V d.c. for 60 seconds.

(3) *Basic protection*

Protection by obstacles or placing out of reach is not permitted.

(4) *Fault protection*

- (a) Fault protection should be provided by one of the following:
 - (i) SELV,
 - (ii) automatic disconnection, a supplementary equipotential bonding conductor should be provided and be connected to the exposed conductive parts of the fixed equipment and the conductive parts of the location,
 - (iii) electrical separation, in which case only one socket or piece of equipment should be connected to each secondary winding of the isolating transformer, or
 - (iv) the use of Class II equipment adequately protected to an IP code (see IEC 60529) in which case the circuit should be further protected by a residual current device having the characteristics specified in Code 11J.
- (b) A supply to or a socket intended to supply a hand lamp should be protected by SELV.
- (c) If a functional earth is required for certain equipment, for example measurement or control apparatus, equipotential bonding should be provided between all exposed conductive parts, all extraneous conductive parts inside the restrictive conductive location, and the functional earth.
- (d) A supply to or a socket intended to supply a handheld tool should be protected by SELV or electrical separation.
- (e) A supply to fixed equipment should be protected by one of the methods listed in subparagraph (a) above.

- (f) Every safety source and isolating source, other than an electro-chemical source (e.g. a battery) or another source independent of a higher voltage circuit (e.g. an engine driven generator), should be situated outside the restrictive conductive location, unless it is part of a fixed installation which satisfies subparagraph (a) above within a permanent restrictive conductive location.

260 **Installation of Equipment Having High Earth Leakage Currents**

- (a) The particular requirements of this Code should apply to every installation supplying equipment having a high earth leakage current (usually exceeding 3.5 mA), including information technology equipment to IEC 60950 and industrial control equipment where values of earth leakage current in normal service permitted by recognised standards necessitate special precautions being taken in the installation of the equipment.
- (b) Where more than one item of stationary equipment having an earth leakage current exceeding 3.5 mA in normal service is to be supplied from an installation incorporating a residual current device, it should be verified that the total leakage current does not exceed 25% of the nominal tripping current of the residual current device.

Where compliance with this Code cannot be otherwise achieved, the items of equipment should be supplied through a double-wound transformer or equivalent device as described in paragraph (f)(vi) of this Code.

- (c) An item of stationary equipment having an earth leakage current exceeding 3.5 mA but not exceeding 10 mA in normal service should either be permanently connected to the fixed wiring of the installation without the use of a plug and socket outlet or should be connected by means of a plug and socket outlet complying with IEC 60309-2 or equivalent.
- (d) An item of stationary equipment having an earth leakage current exceeding 10 mA in normal service should preferably be permanently connected to the fixed wiring of the installation. Alternatively, one of the following precautions should be taken:
 - (i) the equipment may be connected by means of a plug and socket outlet complying with IEC 60309-2 provided that the protective conductor of the associated flexible cable is supplemented by a separate contact and a second protective conductor having a cross-sectional area not less than 4 mm² or the flexible cable complies with paragraph (f)(iii) of this Code with the second protective conductor connected via a separate contact within the

plug. The permanent connection to the fixed wiring may be by means of a flexible cable, or

- (ii) a monitoring system to BS4444 may be installed which, in the event of a discontinuity in the protective conductor, automatically disconnects the supply by a residual current device complying with relevant recognised standards and having the characteristic specified in Code 11J or an overcurrent protective device described in Code 9.
- (e) For a final circuit supplying a number of socket outlets in a location intended to accommodate several items of equipment, where it is known or is reasonably to be expected that the total earth leakage current in normal service will exceed 10 mA, the circuit should be provided with a high integrity protective connection complying with one or more of the arrangements described in paragraph (f)(i) to (f)(vi) of this Code. Alternatively a ring circuit may be used to supply a number of single socket outlets. There should be no spur from the ring and the supply ends of the protective conductor ring should be separately connected at the distribution board. The minimum size of the ring protective earth conductor should be 1.5 mm².
- (f) The fixed wiring of every final circuit intended to supply an item of stationary equipment having an earth leakage current exceeding 10 mA in normal service should be provided with a high integrity protective connection complying with one or more of the arrangements described below:
- (i) a single protective conductor with a cross-sectional area of not less than 10 mm²;
 - (ii) separate duplicated protective conductors, having independent connections complying with Code 25D, each having a cross-sectional area not less than 4 mm²;
 - (iii) duplicate protective conductors incorporated in a multicore cable together with the live conductors of the circuit, provided that the total cross-sectional area of all the conductors of the cable is not less than 10 mm². One of the protective conductors may be formed by a metallic armour, sheath or braid incorporated in the construction of the cable and complying with Code 11C;
 - (iv) duplicate protective conductors formed by metal conduit, trunking or ducting complying with Code 11C, and by a conductor having a cross-sectional area not less than 2.5 mm² installed in the same enclosure and connected in parallel with it;
 - (v) an earth monitoring device which, in the event of a discontinuity in the protective conductor, automatically disconnects the supply of the equipment;
 - (vi) connection of the equipment to the supply by means of a double-wound transformer or other unit in which the input and output

circuits are electrically separated, the circuit protective conductor is connected to the exposed conductive parts of the equipment and to a point of the secondary winding of the transformer or equivalent device. The protective conductor(s) between the equipment and the transformer should comply with one of the arrangements described in (i) to (iv) above.

Except where paragraph (d) of this Code applies, each protective conductor mentioned in (i) to (iv) above should comply with the requirements of Codes 11B, 11C and paragraph (e) of this Code.

- (g) Where items of stationary equipment having an earth leakage current exceeding 3.5 mA in normal service are to be supplied from an installation forming part of a TT system, it should be verified that the product of the total earth leakage current (in amperes) and the resistance of the installation earth electrodes (in ohms) does not exceed 25 volts.

Where compliance with this requirement cannot be otherwise achieved, the items of equipment should be supplied through a double-wound transformer or equivalent device as described in paragraph (f)(vi) of this Code.

26P **Renewable Energy Power System**

(1) *Scope*

The particular requirements of this Code should apply to renewable energy power system (REPS) installations.

(2) *Selection and erection of installation*

The REPS installation should be selected and erected to ensure safe operation and ease of maintenance at all times. The REPS should be designed and installed in accordance with the requirements specified in the Technical Guidelines on Grid Connection of Renewable Energy Power Systems published by the Energy Efficiency Office (EEO) of EMSD as appropriate and other relevant national / international standards such as IEC 60364-7-712, IEC 61400-2, BS 7671 or equivalent.

(3) *Inspection, testing and maintenance*

An owner of the REPS should ensure that the REPS and its associated electrical equipment be regularly inspected and maintained in a safe and proper working condition in accordance with manufacturer's guidelines / instructions and the relevant requirements in the CoP. For REPS connected in parallel with supply from an electricity supplier, special attention should be paid to ensure that the REPS should be automatically disconnected from the mains supply when the mains supply was tripped. During maintenance, the power generation side of REPS should be isolated to

prevent electric shock to electrical workers, as the REPS can still be energised even when the REPS is isolated from the a.c. side.

26Q **Temporary Electrical Installation for Exhibitions, Shows, Stands and Festive Lighting**

(1) *Scope*

The particular requirements of this Code should apply to temporary electrical installation including those used for exhibitions, shows, stands, etc. and festive lighting.

(2) *General*

- (a) Every temporary electrical installation should comply with the requirement of the Wiring Regulations.
- (b) The external influence conditions of the particular location where the temporary electrical installation is erected, e.g. the presence of water or mechanical stresses, should be taken into account.

(3) *Design consideration*

(a) *Selection and erection of installation*

- (i) Control and protective switchgear should be placed in closed cabinets which can only be opened by the use of a key or a tool, except for those parts designed and intended to be operated by ordinary persons.
- (ii) Armoured cables or cables protected against mechanical damage should be used whenever there is a risk of mechanical damage.
- (iii) Wiring cables should be copper and have a minimum cross-sectional area of 1.5 mm², and should comply with an appropriate recognised standard for either thermoplastic or thermosetting insulated electric cables.
- (iv) Flexible cords should not be laid in areas accessible to the public unless they are protected against mechanical damage.
- (v) An adequate number of socket outlets should be installed to allow user requirements to be met safely. Where a floor-mounted socket outlet is installed, it should be adequately protected from the accidental ingress of water.

(b) *Protection against earth leakage*

- (i) Each socket outlet circuit and all final circuits other than for emergency lighting should be protected by a Residual Current Device (RCD) having the characteristics specified in Code 11J.
- (ii) A cable intended to supply temporary structures should be provided at its origin by an RCD having a rated residual operating current not exceeding 300 mA. This device should provide a delay by using a device in accordance with BS EN 60947-2, or be of "Type S" in accordance with BS EN 61008-1 or BS EN 61009-1 for discrimination with RCDs protecting final circuits.
- (iii) Structural metallic parts which are accessible from within the stand, container, etc. should be bonded to the earthing terminal.

(c) *Precaution against danger*

All equipment and cables exposed to weather, corrosive atmosphere or damp conditions should be of the weather proof type or contained in weather proof enclosures suitable for the conditions.

(d) *Protection against fire*

Where no fire alarm system is installed in a building used for exhibitions etc. cable systems should be either:

- (i) flame retardant to BS EN 60332-1-2 or to a relevant part of the BS EN 50266 series, and low smoke to BS EN 61034-2, or
- (ii) single-core or multicore unarmoured cables enclosed in metallic or non-metallic conduit or trunking, providing fire protection in accordance with BS EN 61386 series or BS EN 50085 series and providing a degree of protection of at least IP4X.

(e) *Isolation*

Every separate temporary structure, such as a stand or unit, intended to be occupied by one specific user and each distribution circuit supplying outdoor installations should be provided with its own readily accessible and properly identifiable means of isolation.

(f) *Supply from generator set*

Where the electricity supply for the temporary electrical installation is obtained from a generator set, the TN-S earthing system should be used.

26R **Electric Heating Systems installed in Building Structures**

- (a) RCDs with a rated residual operating current not exceeding 30 mA should be used as disconnecting devices for the electric heating systems installed in buildings structures (including floor, wall and ceiling) for the case when appropriate earthed mechanical protection cannot be provided.
- (b) Appropriate degree of mechanical protection on heating elements should be considered to prevent penetration of object and ingress of water, and suitable means of heat dissipation and overheat protection should also be provided to the heating elements.
- (c) Flexible sheet heating elements should comply with the requirements of BS EN 60335-2-96 or IEC 60800, and heating cables should comply with the requirements of BS EN 62395-1 series.
- (d) The manufacturer's installation instructions should be followed.

26S **Charging Facilities for Electric Vehicles**

Charging facilities for electric vehicles should be designed and installed in accordance with the requirements specified in the relevant guidelines published by EMSD as appropriate and other relevant national / international standards or equivalent.

Table 26(1)

Recommended Number of Socket Outlets in Dwellings

Location	Minimum No. of Socket Outlet	Recommended Maximum Floor Area sq. metre Served by a Socket Outlets
Kitchen	3	1.2
Living/Dining Room	4	2.5
Bedroom	2	3
Store	1	—
Utility Room	3	—

Note: A twin socket outlet is regarded as 2 outlets.

Examples of zone dimensions (plan)

a) Bath tub

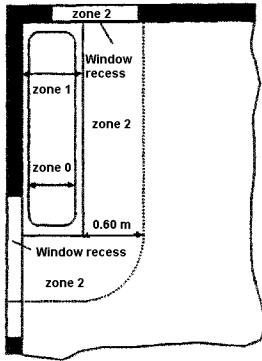

b) Bath tub, with permanent fixed partition

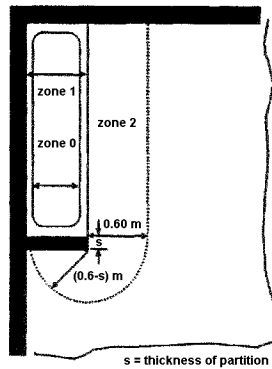

c) Shower basin

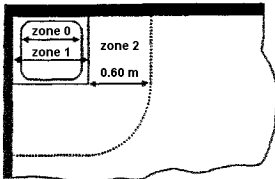

d) Shower basin with permanent fixed partition

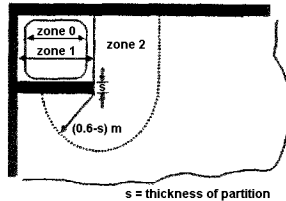

e) Shower, without basin

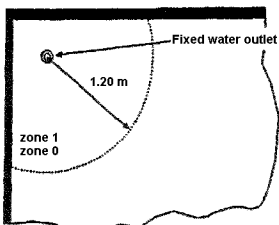

f) Shower, without basin, but with permanent fixed partition

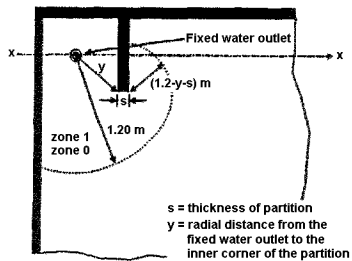

(Note: The information above is extracted from BS 7671.)

CODE No.

26

FIGURE No.

28(1)(a)

CODE OF PRACTICE FOR THE ELECTRICITY (WIRING) REGULATIONS

Examples of zone dimensions (elevation)

a) Bath tub

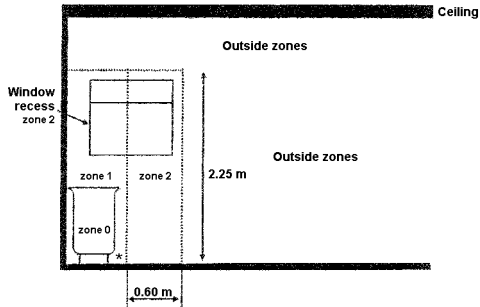

c) Shower basin

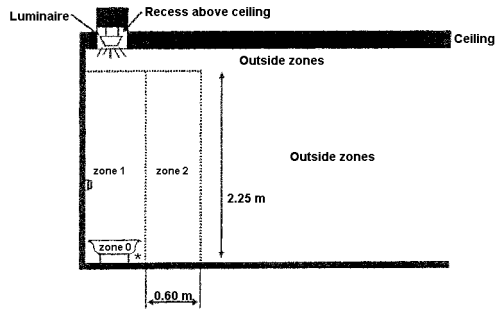

f) Shower, without basin, but with permanent fixed partition

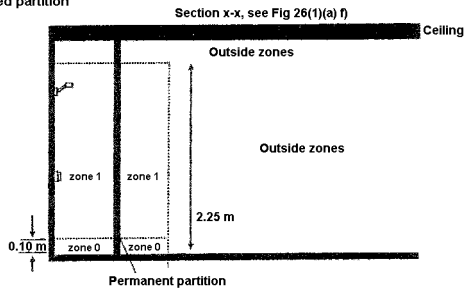

* Zone 1 if the space is accessible without the use of a tool.
Spaces under the bath accessible only with the use of a tool are outside the zones.

(Note: The information above is extracted from BS 7671.)

CODE No.

26

FIGURE No.

26(1)(b)

zone dimensions for a sauna

ELEVATION

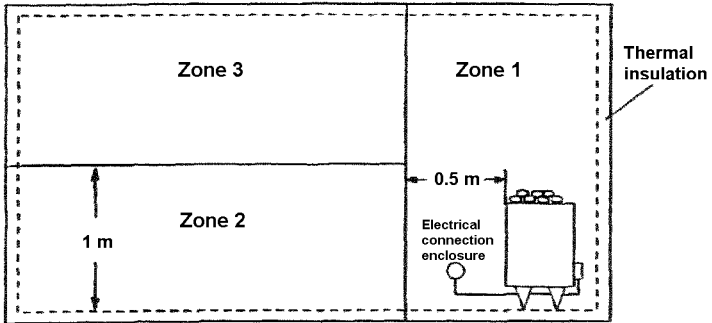

PLAN

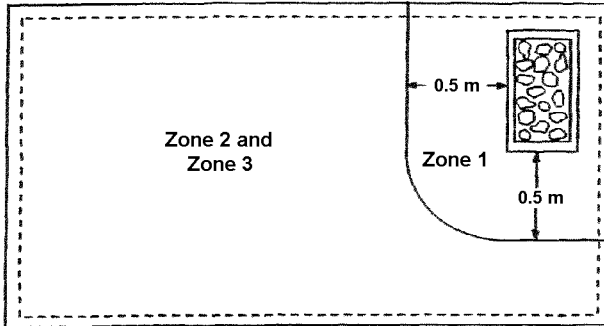

(Note: The information above is extracted from BS 7671.)

CODE No.

26

FIGURE No.

26(2)

zone dimensions for swimming pools and paddling pools

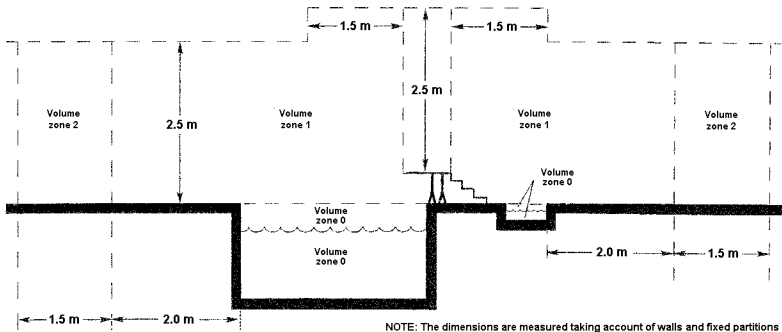

(Note: The information above is extracted from BS 7671.)

CODE No.	26	FIGURE No.	26(3)
----------	----	------------	-------

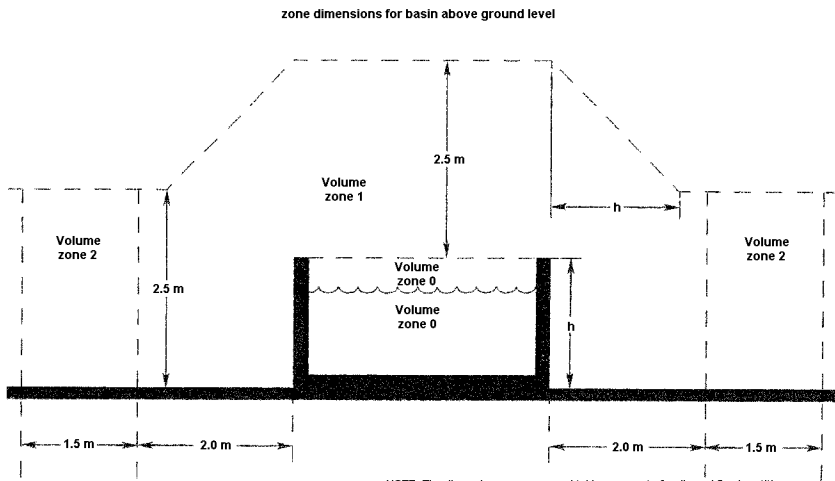

(Note: The information above is extracted from BS 7671.)

CODE No. 26

FIGURE No. 26(4)

Example of zone dimensions (plan) with fixed partitions of height at least 2.5 m

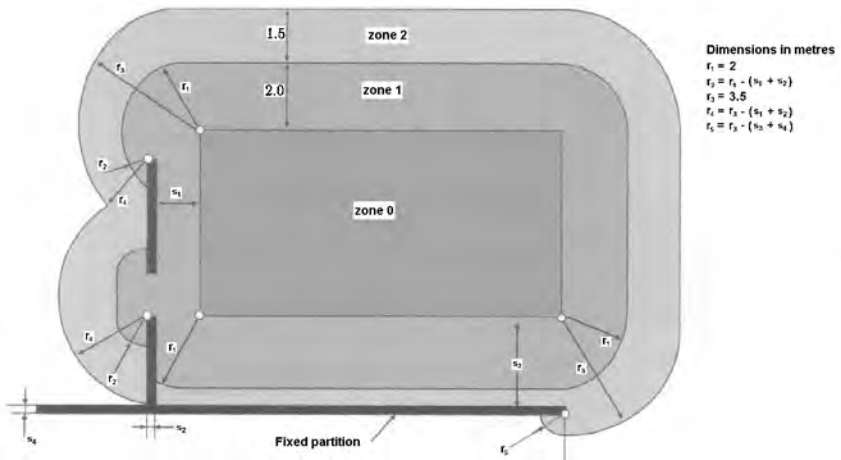

(Note: The information above is extracted from BS 7671.)

CODE No.	26	FIGURE No.	26(5)
----------	----	------------	-------

Example of determination of the zones of a fountain

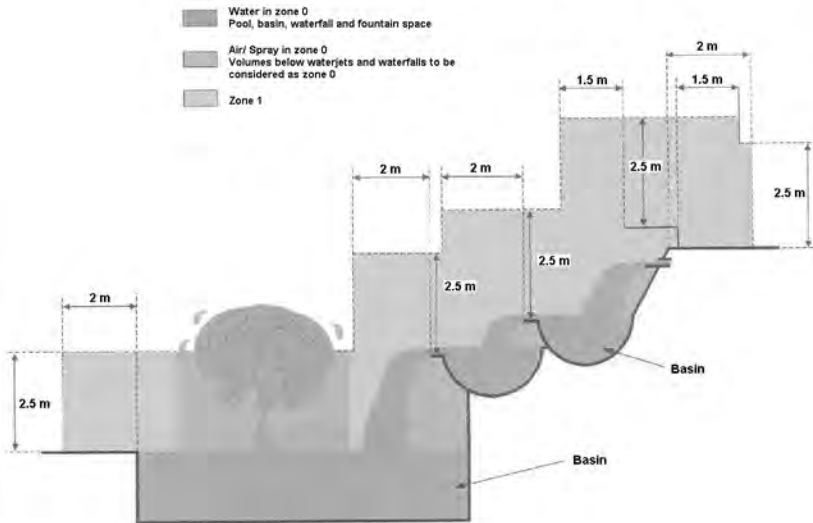

(Note: The information above is extracted from BS 7671.)

CODE No. 26

FIGURE No. 26(6)

APPENDICES

1. Prescribed Requirements for 3-pin (non-reversible) 5 ampere and 15 ampere Socket Outlets
2. Prescribed Requirements for 3-pin (non-reversible) 13 ampere Socket Outlets
3. Prescribed Requirements for Protected Type Non-reversible 5 ampere, 15 ampere and 30 ampere Socket Outlets
4. Prescribed Requirements for Industrial Type 16 ampere, 32 ampere, 63 ampere and 125 ampere Socket Outlets with Retaining Devices
5. Rating Factors for Sizing of Cable Conductors
6. Current Carrying Capacities and Voltage Drop Tables for PVC Insulated and XLPE Insulated Cables
7. Typical Methods of Installation of Cables
8. Graphical Symbols for Electrical Diagrams
9. Performance Monitoring Points System for Registered Electrical Workers / Contractors
10. Degree of Protection Provided by Enclosures (IP Code)
11. Forms of Internal Separations for Switchgear Assemblies
12. (Reserved for Future Uses)
13. Sample of Schedule of Test Results for Electrical Wiring and Checklists
14. References
15. Safety for Live Work
16. Sample of Permit-To-Work / Sanction-For-Test
17. Sample of H.V. Enclosure Log Book / H.V. Padlock Movement Log Book
18. New Cable Colour Code for Fixed Electrical Installations - Installation Guidelines

Appendix 1

Prescribed Requirements for 3-pin (non-reversible) 5 ampere and 15 ampere Socket Outlets

(1) General

A 5A or 15A socket outlet to BS 546 is acceptable as complying with the prescribed requirements of this appendix.

(2) Materials for plate/cover, base and current carrying parts

- (a) Parts made of ferrous metal should be rendered rust proof, special attention being given to springs and moving parts.
- (b)
 - (i) Insulating materials should be tough, non-ignitable and having a plastic yield not exceeding 6 mm when heated to a temperature of 100°C in accordance with the plastic yield test method 102A of BS2782 Part 1 or equivalent.
 - (ii) Current carrying parts, including earthing contact should be made of brass, copper, phosphor-bronze, and/or other suitable material.
 - (iii) A shutter if provided, the distortion of the material should not be such as to impede its action.
 - (iv) The enclosure of the socket outlet should be rigid and be capable of withstanding a minimum force of 4 kg applied over an area of 250 mm² anywhere on the surface without causing appreciable damage or reducing the protective clearance below the minimum values specified in paragraph (6).

(3) Construction of socket outlet

- (a)
 - (i) Socket outlets are to be constructed to accommodate the plug having physical dimensions as detailed in Figure A1(1).
 - (ii) In this appendix, where reference is made to a plug, it means a plug having a corresponding rating and dimensions as detailed in Figure A1(1).
- (b) The configuration of the socket contacts should be as shown in Figure A1(2).
- (c) There should be no projection on the minimum engagement surface of the socket outlet within a circle having the radius illustrated in Figure A1(2) and concentric with a circle through the centres of the contacts, such as would prevent the full insertion of a plug. Raised marking is permitted provided it does not project more than 0.5 mm from the engagement surface.

- (d) The spacing of the socket contacts should correspond with that of the plug pins as shown in Figure A1(1).
- (e) On insertion of pins into contacts, the travel from the first point of contact to the complete engagement, should not be less than the minimum, or more than the maximum, given in Table A1(1).

Table A1(1) Contact Travel

Current Rating (ampere)	Minimum (mm)	Maximum (mm)
5	4.17	6.25
15	4.75	6.83

- (f) Socket contacts should be self-adjusting as to contact making and each socket contact should be such as to make and maintain, in normal use, effective electrical and mechanical contact with the corresponding plug pins. The means for producing the contact pressure should be associated with each socket contact independently such that individual line or neutral socket contact should be capable of retaining the withdrawal—pull of a gauge as detailed in Figure A1(3) for 30 sec. when the socket outlet is held horizontally with the gauge hanging vertically downwards. It should be checked that neither shutter nor the cover/moulding has any effect on the results.
- (g) Where a shutter is provided, the construction of the socket outlet should be such that when a plug is withdrawn from it, the current carrying socket contacts are automatically screened by the shutter. The shutter should be operated by the insertion of the earthing pin.
- (h)
 - (i) Unless a shutter is provided, diameter of holes in the socket outlet plate or cover for the reception of the line and the neutral plug pins should not exceed 5.8 mm or 7.7 mm for 5A or 15A socket outlet respectively.
 - (ii) The holes for the line and the neutral plug pins in metal plates should have insulated material of at least 2 mm thick around them.
- (i) The socket outlet should be constructed to prevent a current carrying pin of a plug from making contact with a current carrying contact of the socket while either or both of other pins are completely exposed. The provision of a shutter, or no part of hole intended for the reception of line or neutral pin should be less than 16.5 mm or 21 mm from the edge of a 5A or 15A socket outlet respectively, is acceptable for this purpose.

- (j) Multiple socket outlets should be capable of simultaneous use of all socket outlets.
- (k) Where a switch is incorporated:
 - (i) the actuating member of a switch should not remain at rest in the off position whilst the switch contacts remain closed; and
 - (ii) the actuating mechanism should be so constructed that when operated the switch can remain only in a position giving adequate contact or adequate separation of the contacts; and
 - (iii) switches should be so constructed that undue arcing cannot occur when the switch is operated slowly; and
 - (iv) the switch in any switched socket outlet should disconnect the supply to the line socket contact.
- (l) Conductive component parts of the socket outlet should be so located and separated that, in normal use, they cannot be displaced so as to affect adversely the safety or proper operation of the socket outlet.
- (m)
 - (i) For the flush socket outlet intended to be used in enclosure, the size of the base shall be such that the clearance for the purpose of wiring between the base and the inside walls of the box or enclosure is not less than 6 mm.
 - (ii) There should be no live metal protruding from or flush with the socket outlet base. Any exposed live metal part should be recessed at least 2.5 mm from the base surface.
 - (iii) Where it is intended that the fixed wiring conductors pass through holes in the base of the socket outlet to the terminals, the minimum diameter of each hole should not be less than 7.9 mm or 9.5 mm for the 5A or 15A socket outlet respectively.

(4) Construction of terminals

- (a) Terminals in the 5A socket outlet should permit the connection, without special preparation, of one or two 1.5 mm² solid or stranded conductors.
- (b) Line and neutral terminals in the 15A socket outlet should permit the connection, without special preparation, of one or two 2.5 mm² solid or stranded conductors.
- (c) Earthing terminals should permit the connection without special preparation of one or two 1.5 mm² or 2.5 mm² solid or stranded conductors.
- (d) Where pillar terminals are used they should have clamping screws of sufficient length to extend to the far side of the conductor hole. The end of the screw should be slightly rounded so as to minimize damage to the conductors. The sizes of the conductor hole and the clamping screw should be such that the clearance between the sides of the major

diameter of the clamping screw and the conductor hole does not exceed 0.6 mm. The size of conductor hole should not be less than 3.5 mm or 4.3 mm for 5A or 15A socket outlet respectively.

- (e) Terminal screws should have a nominal diameter of not less than 2.8 mm or 3 mm for 5A or 15A socket outlets.

(5) Screws and connections

- (a) Screwed connections, electrical and otherwise should withstand the mechanical stresses occurring in normal use. Screws transmitting electrical contact pressure should screw into metal.
- (b) Screws should not be of insulating material if their replacement by a metal screw would affect the safety or performance requirements of the accessory.
- (c) Where current carrying parts are screwed together, the current path should not rely on the screw threads.

(6) Creepage distances, clearances and distances through insulation

- (a) When the socket outlet is correctly assembled and wired with the appropriate cable, the minimum clearance through air and the minimum creepage distance shall be 2.5 mm:
 - (i) between live parts of opposite polarity;
 - (ii) between live parts and any other metal parts; and
 - (iii) between live parts and the accessible external surface of the accessory.
- (b) The minimum clearance between switch contacts in the open position for socket outlet should be 1.2 mm.
- (c) The socket outlet should have a minimum distance of 2 mm between insulated live parts and the accessible external surface.

(7) Provision of earthing

- (a) The socket outlet should be so constructed that, when inserting the plug, the earth connection is made before the current carrying pins of the plug become live. When withdrawing the plug, the current carrying parts should separate before the earth contact is broken.
- (b) All accessible metal parts of accessories should be in effective electrical contact with the earthing socket contact except the metal parts on, or screws in or through, non-conducting material, and separated by such material from current carrying parts in such a way that in normal use they cannot become live, need not be in effective electrical contact with the earthing socket contact.

(8) Marking

- (a) The socket outlet should be legibly and durably marked with the following information, which should not be placed on screws, removable washers or other easily removable parts, or upon parts intended for separate sale:
- (i) rated current;
 - (ii) rated voltage;
 - (iii) nature of supply.
- (b) If symbols are used they should be as follows:
- | | |
|---------------------|--------------|
| amperes | A |
| volts | V |
| alternating current | a.c. |
| earth | \perp or E |
- (c) The letters L and N should be used to indicate the terminals corresponding respectively to the line socket contact (L) and the neutral socket contact (N) and letter E or symbol \perp for the earthing socket contact (E). The letters and symbols should be as close as practicable to the corresponding terminals.

(9) Temperature rise

- (a) The permitted temperature rise of the accessible external surface of the socket outlet after the test of subparagraph (b) should be 50°C.
- (b) The following procedures of the test on the temperature rise of the accessible external surface of the socket outlet are acceptable:
- (i) Temperature rise of socket outlets should be measured by fine wire thermocouples.
 - (ii) Surface mounted outlets should be mounted as in use with their accompanying mounting block or backplate fixed to a vertical plywood board 25 mm thick and having a flat surface extending at least 150 mm in each direction beyond the extremity of the socket outlet.
 - (iii) Flush mounted socket outlets should be mounted on socket outlet boxes with an internal depth of 35 mm. The flush mounted socket outlet box is placed in a block of wood, so that the front edges of the box are between 2.5 mm and 5 mm below the front surface of the block. The size of the block should be such that there is a minimum of 25 mm of wood surrounding the box on all four sides and the back.
 - (iv) Socket outlets under test should be subjected to its rated loading connected via a plug for a minimum continuous period of 4 hours or longer until stability is reached with a maximum duration of 8 hours, stability being taken as less than 1°C rise within 1 hour.

CODE OF PRACTICE FOR THE ELECTRICITY (WIRING) REGULATIONS

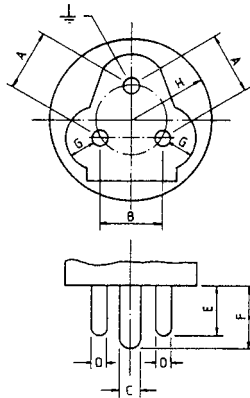

RATED CURRENT (AMPERE)	DIMENSIONS IN mm							
	A	B	C	D	E	F	G (NOTE 1)	H (NOTE 2)
5	22.22	19.05	7.04 TO 7.09	5.05 TO 5.1	14.73 TO 15.62	20.5 TO 21.39	7.94	27.2
15	28.58	25.4	8.69 TO 8.74	7.04 TO 7.09	18.49 TO 19.38	28.45 TO 29.34	9.52	32.3

NOTES :- (1) "G" IS THE MINIMUM DISTANCE BETWEEN THE PINS AND THE PERIPHERY OF THE PLUG.

(2) "H" IS THE RADIUS OF THE MAXIMUM PERMISSIBLE PLUG CONTOUR. THE RADIUS IS CONCENTRIC WITH THE PITCH CIRCLE RADIUS OF THE PINS.

3 PIN 5 AMPERE AND 15 AMPERE PLUGS

CODE No. A1	FIGURE No. A1(1)	
----------------	---------------------	--

CODE OF PRACTICE FOR THE ELECTRICITY (WIRING) REGULATIONS

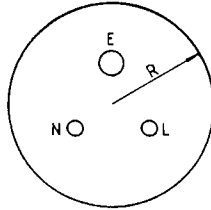

	RATED CURRENT	
	5 A	15 A
RADIUS OF ENGAGEMENT SURFACE (R)	27.2 mm	32.3 mm

CONFIGURATION OF THE SOCKET CONTACTS AND ENGAGEMENT SURFACE OF 5 AMPERE AND 15 AMPERE SOCKET OUTLETS

CODE No.

A1

FIGURE No.

A1(2)

CODE OF PRACTICE FOR THE ELECTRICITY (WIRING) REGULATIONS

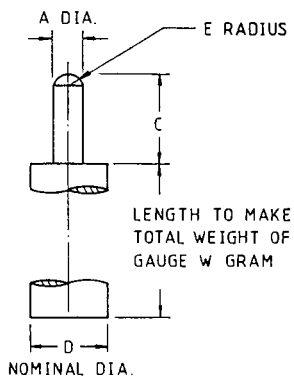

CURRENT RATING	CONTACTS	A	C	D	W	E
AMPERE		mm	mm	mm	GRAM	mm
5	CURRENT CARRYING	5.05	14.86	15.88	226.8	2.74
	EARTHING	7.04	20.63	19.05	226.8	4.01
15	CURRENT CARRYING	7.04	18.62	19.05	340.2	4.01
	EARTHING	8.69	28.56	22.23	340.2	5.05
TOLERANCE		- 0.008	± 0.025		+ 1.8	± 0.127

**WITHDRAWAL-PULL GAUGES FOR 5 AMPERE AND
15 AMPERE SOCKET OUTLETS**

CODE No. A1	FIGURE No. A1(3)	
----------------	---------------------	--

Appendix 2

Prescribed Requirements for 3-pin (non-reversible) 13 ampere Socket Outlets

(1) General

A 13A outlet to BS 1363 is acceptable subject to complying with the prescribed requirements of this appendix.

(2) Materials for plate/cover, base and current carrying parts

- (a) Parts made of ferrous metal should be rendered rust proof, special attention being given to springs and moving parts.
- (b)
 - (i) Insulating materials should be tough, non-ignitable and not soften when heated to a temperature of 100°C
 - (ii) Current carrying parts, including earthing contact should be made of brass, copper, phosphor-bronze, and/or other suitable material.
 - (iii) The material of the shutter should not distort to an extent to impede its action.
 - (iv) The enclosure of the socket outlet should be rigid and be capable of withstanding a minimum force of 4 kg applied over an area of 250 mm² anywhere on the surface without causing appreciable damage or reducing the protective clearance below the minimum values specified in paragraph (6).

(3) Construction of socket outlet

- (a)
 - (i) Socket outlets are to be constructed to accommodate the plug having physical dimensions as detailed in Figure A2(1).
 - (ii) In this appendix, where reference is made to a plug, it means a plug having a current rating and dimensions of 13A as detailed in Figure A2(1).
- (b) The configuration of the socket contacts should be as shown in Figure A2(2).
- (c) There should be no projection on the minimum engagement surface of the socket outlet illustrated in Figure A2(2), such as would prevent the full insertion of a plug. Raised marking is permitted provided it does not project more than 0.5 mm from the engagement surface.
- (d) The spacing of the socket contacts should correspond with that of the plug pins as shown in Figure A2(1).
- (e) On insertion of pins into contacts, the travel of the end of either current carrying pin from the first face of the socket outlet to the first point of

contact with appropriate socket contact, should not be less than the minimum of 9.5 mm, or more than the maximum of 12.7 mm.

- (f) Socket contacts should be self-adjusting as to contact making and each socket contact should be such as to make and maintain, in normal use, effective electrical and mechanical contact with the corresponding plug pins. The means for producing the contact pressure should be associated with each socket contact independently such that individual line or neutral socket contact should be capable of retaining the gauge as detailed in Figure A2(3) for 30 sec. when the socket outlet is held horizontally with the gauge hanging vertically downwards. It should be checked that neither shutter nor the cover/moulding has any effect on the results.
- (g) The construction of the socket outlet should be such that when a plug is withdrawn from it, the current carrying socket contacts are automatically screened by the shutter. The shutter should be operated by the insertion of the earthing pin.
- (h)
 - (i) Apertures of the socket outlet plate or cover for the reception of the line and the neutral plug pins should not exceed 7.2 mm × 4.8 mm and for the earthing plug pin 8.8 mm × 4.8 mm.
 - (ii) The holes for the line and the neutral plug pins in metal plates should have insulated material of at least 2 mm thick around them.
- (i) No part of the aperture intended for the reception of the line or neutral pin should be less than 9.5 mm from the periphery of the engagement face of a socket outlet.
- (j) Multiple socket outlets should be capable of simultaneous use of all socket outlets.
- (k) Where a switch is incorporated:
 - (i) the actuating member of a switch should not remain at rest in the off position whilst the switch contacts remain closed; and
 - (ii) the actuating mechanism should be so constructed that when operated the switch can remain only in a position giving adequate contact or adequate separation of the contacts; and
 - (iii) switches should be so constructed that undue arcing cannot occur when the switch is operated slowly; and
 - (iv) the switch in any switched socket outlet should disconnect the supply to the line socket contact.
- (l) Conductive component parts of the socket outlet should be so located and separated that, in normal use, they cannot be displaced so as to affect adversely the safety or proper operation of the socket outlet.
- (m)
 - (i) For the flush socket outlet intended to be used in enclosure, the size of the base shall be such that the clearance for the purpose of wiring

between the base and the inside walls of the box or enclosure is not less than 6 mm.

- (ii) There should be no live metal protruding from or flush with the socket outlet base. Any exposed live metal part should be recessed at least 2.5 mm from the base surface.
- (iii) Where it is intended that the fixed wiring conductors pass through holes in the base of the socket outlet to the terminals, the minimum diameter of each hole should not be less than 9.5 mm.

(4) Construction of terminals

- (a) Line and neutral terminals in the socket outlet should permit the connection, without special preparation, of one, two or three 2.5 mm² solid or stranded or of one or two 4 mm² stranded conductors.
- (b) Earthing terminals should permit the connection without special preparation, of one, two or three 1.5 mm² or 2.5 mm² solid or stranded or of one or two 4 mm² stranded conductors.
- (c) Where pillar terminals are used they should have clamping screws of sufficient length to extend to the far side of the conductor hole. The end of the screw should be slightly rounded so as to minimize damage to the conductors. The sizes of the conductor hole and the clamping screw should be such that the clearance between the sides of the major diameter of the clamping screw and the conductor hole does not exceed 0.6 mm. The size of conductor hole should not be less than 4.3 mm.
- (d) Terminal screws should have a nominal diameter of not less than 3 mm.

(5) Screws and connections

- (a) Screwed connections, electrical and otherwise should withstand the mechanical stresses occurring in normal use. Screws transmitting electrical contact pressure should screw into metal.
- (b) Screws should not be of insulating material if their replacement by a metal screw would affect the safety or performance requirements of the accessory.
- (c) Where current carrying parts are screwed together, the current path should not rely on the screw threads.

(6) Creepage distances, clearances and distances through insulation

- (a) When the socket outlet is correctly assembled and wired with the appropriate cable, the minimum clearance through air and the minimum creepage distance shall be 2.5 mm:
 - (i) between live parts of opposite polarity;

- (ii) between live parts and any other metal parts; and
 - (iii) between live parts and the accessible external surface of the accessory.
- (b) The minimum clearance between switch contacts in the open position for socket outlet should be 1.2 mm.
- (c) The socket outlet should have a minimum distance of 2 mm between insulated live parts and the accessible external surface.

(7) Accessibility of live parts

Socket outlets should be so designed that when mounted and wired as in normal use, live parts are not accessible as tested by a test pin shown in Figure A2(4).

(8) Provision of earthing

- (a) The socket outlet should be so constructed that, when inserting the plug, the earth connection is made before the current carrying pins of the plug become live. When withdrawing the plug, the current carrying parts should separate before the earth contact is broken.
- (b) All accessible metal parts of accessories should be in effective electrical contact with the earthing socket contact except the metal parts on, or screws in or through, non-conducting material, and separated by such material from current carrying parts in such a way that in normal use they cannot become live, need not be in effective electrical contact with the earthing socket contact.

(9) Marking

- (a) The socket outlet should be legibly and durably marked with the following information, which should not be placed on screws, removable washers or other easily removable parts, or upon parts intended for separate sale:
- (i) rated current;
 - (ii) rated voltage;
 - (iii) nature of supply.
- (b) If symbols are used they should be as follows—
- | | |
|---------------------|--------------|
| amperes | A |
| volts | V |
| alternating current | a.c. |
| earth | \perp or E |

- (c) The letters L and N should be used to indicate the terminals corresponding respectively to the line socket contact (L) and the neutral socket contact (N) and letter E or symbol \perp for the earthing socket contact (E). The letters and symbols should be as close as practicable to the corresponding terminals.

(10) Temperature rise

- (a) The permitted temperature rise of the accessible external surface of the socket outlet after the test of subparagraph (b) should be 50°C.
- (b) The following procedures of the test on the temperature rise of the accessible external surface of the socket outlet are acceptable:
- (i) Temperature rise of socket outlets should be measured by fine wire thermocouples.
 - (ii) Surface mounted socket outlets should be mounted as in use with their accompanying mounting block or backplate fixed to a vertical plywood board 25 mm thick and having a flat surface extending at least 150 mm in each direction beyond the extremity of the socket outlet.
 - (iii) Flush mounted socket outlets should be mounted on socket outlet boxes with an internal depth of 35 mm. The flush mounted socket outlet box is placed in a block of wood, so that the front edges of the box are between 2.5 mm and 5 mm below the front surface of the block. The size of the block should be such that there is a minimum of 25 mm of wood surrounding the box on all four sides and the back.
 - (iv) Socket outlets under test should be subjected to its rated loading connected via a plug for a minimum continuous period of 4 hours or longer until stability is reached with a maximum duration of 8 hours, stability being taken as less than 1°C rise within 1 hour.

CODE OF PRACTICE FOR THE ELECTRICITY (WIRING) REGULATIONS

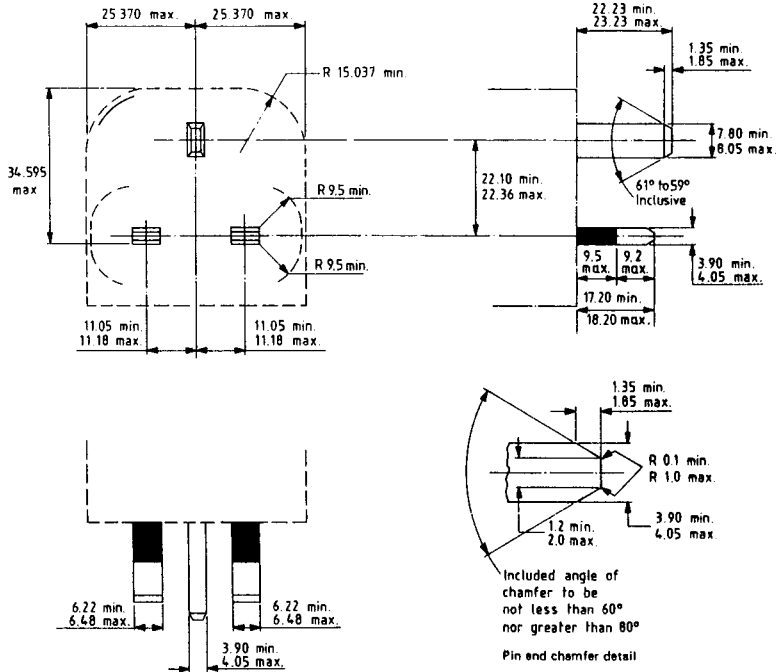

(All dimensions are in mm)

13 AMPERE 3-PIN PLUG

CODE No.	FIGURE No.
A2	A2(1)

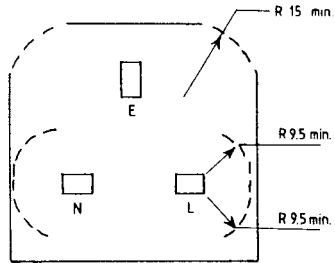

(All dimensions are in mm)

**CONFIGURATION OF THE SOCKET CONTACTS AND
ENGAGEMENT SURFACE OF 13 AMPERE SOCKET OUTLETS**

CODE No.

A2

FIGURE No.

A2(2)

CODE OF PRACTICE FOR THE ELECTRICITY (WIRING) REGULATIONS

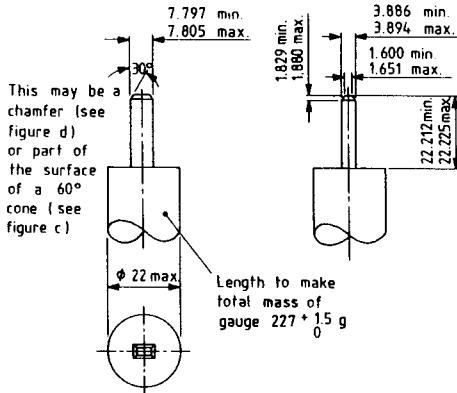

(a) Gauge for earthing socket contact

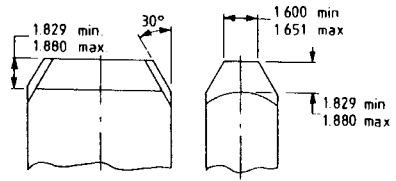

(c) Part of 60° cone for earthing socket contact gauge

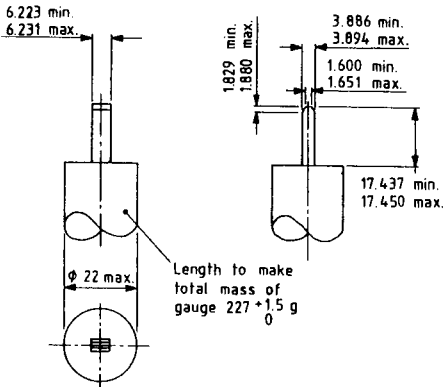

(b) Gauge for line and neutral current carrying socket contacts
All dimensions are in millimetres

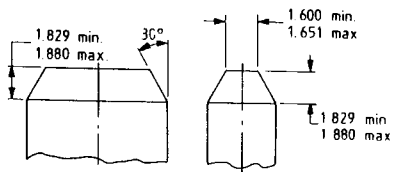

(d) Chamfer of earthing socket contact gauge
(Chamfer on long sides only for line and neutral socket contact gauges)

WITHDRAWAL - PULL GAUGES FOR 13 AMPERE SOCKET OUTLET

CODE No.	FIGURE No.
A2	A2(3)

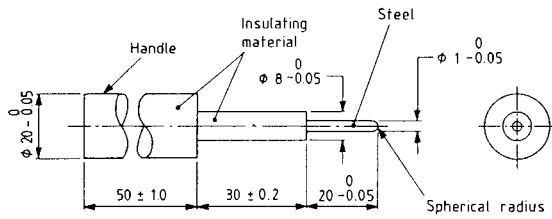

All dimensions are in millimetres.

STANDARD TEST PIN FOR 13 AMPERE SOCKET OUTLET

CODE No.

A2

FIGURE No.

A2(4)

Appendix 3

Prescribed Requirements for Protected Type Non-reversible 5 ampere, 15 ampere and 30 ampere Socket Outlets

(1) General

A 5A or 15A or 30A socket outlet to BS 196 is acceptable as complying with the prescribed requirements of this appendix.

(2) Materials for plate/cover, base and current carrying parts

- (a) Parts made of ferrous metal should be rendered rust proof, special attention being given to springs and moving parts.
- (b)
 - (i) Insulating materials should be tough, non-ignitable and not soften when heated to a temperature of 100°C.
 - (ii) Current carrying parts, including earthing contact should be made of brass, copper, phosphor-bronze, and/or other suitable material.
 - (iii) The enclosure of the socket outlet should be rigid and be capable of withstanding a minimum force of 4 kg applied over an area of 250 mm² anywhere on the surface without causing appreciable damage or reducing the protective clearance below the minimum values specified in paragraph (6).

(3) Construction of socket outlet

- (a)
 - (i) The socket outlet is to be constructed to accommodate the plug having physical dimensions as detailed in Figure A3(1).
 - (ii) In this appendix, where reference is made to a plug, it means a plug having a corresponding rating and dimensions as detailed in Figure A3(1).
- (b) The configuration of the socket contacts should be as shown in Figure A3(2).
- (c) The essential dimensions of the socket outlet fed exclusively by a radial final circuit is shown in Figure A3(2).
- (d) Socket contacts should be self-adjusting as to contact making and each socket contact should such as to make and maintain, in normal use, effective electrical and mechanical contact with the corresponding plug pins. The means for producing the contact pressure should be associated with each socket contact independently.

- (e) Conductive component parts of socket outlets should be so located and separated that, in normal use, they cannot be displaced so as to affect adversely the safety or proper operation of the socket outlet.
- (f) Where the socket outlet is required to be weatherproof, it should be totally enclosed when fitted with screwed conduits, or PVC sheathed cables and without a plug in position. The socket outlets should be threaded with dimensions given in Figure A3(3) for use with the corresponding screwed ring fitted to plugs.
- (g) For a ring or radial final circuit feeding a number of socket outlets and where:
 - (i) the circuit has one pole earthed, the socket outlet should be of the type that will accept only 2-pole-and-earth contact plugs with single-pole fusing on the live pole. Such socket outlets with raised socket keys are shown in Figure A3(4), and those with socket keyways recessed at position 'B' are shown in Figure A3(5).
 - (ii) the circuit has neither pole earthed (e.g. a circuit supplied from a double-wound transformer having the midpoint of its secondary winding earthed), the socket outlet should be of the type that will accept only 2-pole-and-earth contact plugs with double-pole fusing. Such socket outlet is those which have raised socket keys as shown in Figure A3(4), together with socket keyways recessed at position 'P' as shown in figure A3(5).

(4) Construction of terminals

- (a) Connection should be made by means of screws, nuts or equally effective devices.
- (b) When pillar type terminals are used, they should comply with the following requirements:
 - (i) the minimum dimensions are in accordance with Figure A3(2).
 - (ii) the cable clamping screws should be long enough to reach the opposite surface of the cable hole, and should have rounded ends, and
 - (iii) the surface of the cable hole against which the cable is clamped should be smooth and unbroken.
- (c) Terminals should be effectively enclosed. Insulating barriers securely fixed to, or forming an integral part of the interiors, should be provided to separate internal metal at different potential including any bare flexible conductors, even if such conductors should become detached from their terminals.

- (d) An earthing terminal should be provided and be so arranged that the earth wire of the cable, if any, is visible at least when the plug or appliance inlet is removed from the corresponding socket outlet or connector.

(5) Screws and connections

- (a) Screwed connections, electrical and otherwise should withstand the mechanical stresses occurring in normal use. Screws transmitting electrical contact pressure should screw into metal.
- (b) Screws should not be made of insulating material if their replacement by a metal screw would affect the safety or performance requirements of the accessory.
- (c) Where current carrying parts are screwed together, the current path should not rely on the screw threads.

(6) Creepage distances, clearances and distances through insulation

- (a) When the socket outlet is correctly assembled and wired with the appropriate cable, the minimum clearance through air and the minimum creepage distance shall be 2.5 mm:
 - (i) between live parts of opposite polarity;
 - (ii) between live parts and any other metal parts; and
 - (iii) between live parts and the accessible external surface of the accessory.
- (b) The socket outlet should have a minimum distance of 2 mm between insulated live parts and the accessible external surface.

(7) Accessibility of live parts

Socket outlets should be so designed that when mounted and wired as in normal use, live parts are not accessible as tested by a test finger shown in Figure A3(6).

(8) Provision of earthing

- (a) Socket outlets should be so constructed with scraping earthing contact that, when inserting the plug, the earth connection is made before the current carrying pins of the plug become live. When withdrawing the plug, the current carrying parts should separate before the earth contact is broken.

- (b) All accessible metal parts at accessories shall be in effective electrical contact with the scraping earthing contact except that metal parts on, or screws in or through, non-conducting material, and separated by such material from current carrying parts in such a way that in normal use they cannot become live, need not be in effective electrical contact with the scraping earthing contact.

(9) Marking

- (a) The socket outlet should be legibly and durably marked with the following information, which should not be placed on screws, removable washers or other easily removable parts, or upon parts intended for separate sale:

- (i) rated current;
- (ii) rated voltage;
- (iii) nature of supply.

- (b) If symbols are used they should be as follows:

amperes	A
volts	V
alternating current	a.c.
earth	\perp or E

- (c) The letters L and N should be used to indicate the terminals corresponding respectively to the line socket contact (L) and the neutral socket contact (N) and letter E or symbol \perp for the earthing socket contact (E). The letters and symbols should be as close as practicable to the corresponding terminals.

(10) Temperature rise

- (a) The permitted temperature rise of the accessible external surface of the socket outlet after the test of subparagraph (b) should be 50°C.
- (b) The following procedures of the test on the temperature rise of the accessible external surface of the socket outlet are acceptable:
- (i) Temperature rise of socket outlets should be measured by fine wire thermocouples.
 - (ii) Socket outlets under test should be subjected to its rated loading connected via a plug for a minimum continuous period of 1 hour.
 - (iii) Sockets and plugs should be mounted and connected as in normal use.

CODE OF PRACTICE FOR THE ELECTRICITY (WIRING) REGULATIONS

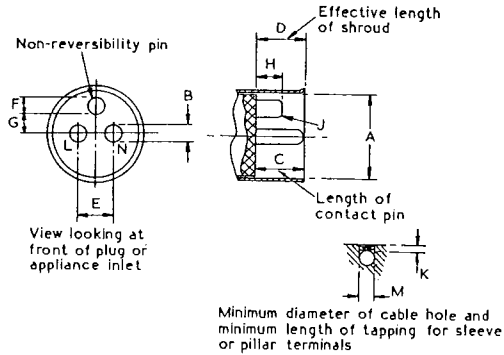

Current rating of plug	A dia.	B dia.	C	D	E	F dia.	G	H	J radius	K min.	M dia. min.
5	35.71	5.11	17.48	17.48	15.88	7.14	8.33	9.52	0.40	1.65	2.64
15	42.06	7.09	22.22	22.22	19.05	7.95	9.52	12.70	2.38	3.18	3.58
30	54.76	7.95	30.18	30.18	22.18	11.13	11.13	15.88	3.18	4.75	4.75
Tolerance	+0 -0.13	+0 -0.05	+0 -0.25	+0.25 -0.25	— —	+0.13 -0.13	+0.25 -0.25	+0.25 -0.25	— —	— —	— —

**DIMENSIONS OF 5 AMPERE, 15 AMPERE AND 30 AMPERE
PROTECTED TYPE NON-REVERSIBLE PLUGS**

CODE No. A3	FIGURE No. A3(1)
----------------	---------------------

CODE OF PRACTICE FOR THE ELECTRICITY (WIRING) REGULATIONS

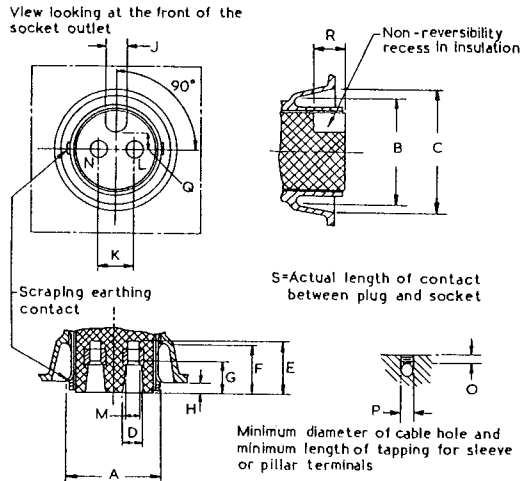

Current rating of socket	A	B	C	D	E	F	G	H	J	K	M	O	P	Q	R	S
	dia.	dia. min.	dia. max.	dia. ori- face max.	min.						dia. ori- face max.	min.	dia. min.		min.	min.
5	35.97	41.28	44.83	6.55	19.05	17.48	9.52	3.18	9.52	15.88	5.72	1.65	3.56	7.14	12.70	4.78
15	42.32	47.62	51.21	8.94	23.83	22.22	11.13	0.41	11.13	19.05	8.10	3.18	4.37	7.95	15.88	6.35
30	55.02	62.69	69.85	10.52	31.75	30.18	17.48	1.60	14.30	22.23	8.89	4.75	6.35	9.52	19.05	7.95
Tolerance	+0.12 -0	—	—	—	—	+0.13 -0.13	+0.25 -0.25	—	+0.50 -0.50	—	—	—	—	+0.50 -0.50	—	—

**CONFIGURATION OF SOCKET CONTACTS AND DIMENSIONS OF
5 AMPERE, 15 AMPERE AND 30 AMPERE PROTECTED TYPE
NON-REVERSIBLE SOCKET OUTLETS**

CODE No.	FIGURE No.
A3	A3(2)

Screwed ring fittings
for weatherproof models

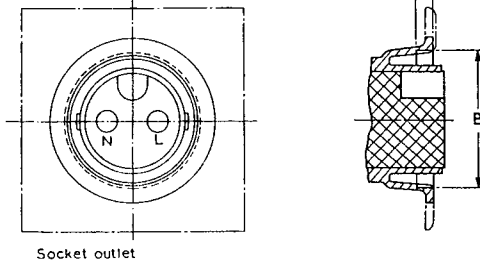

Socket outlet

SOCKET OUTLET DIMENSIONS

Current rating of tubes	A	B major diameter
amperes	mm	mm
5	6.35	47.63
15	6.35	53.98
30	6.35	73.03

SCREWED RING FITTINGS FOR 5 AMPERE, 15 AMPERE AND 30 AMPERE PROTECTED TYPE NON-REVERSIBLE SOCKET OUTLET

CODE No.

A3

FIGURE No.

A3(3)

CODE OF PRACTICE FOR THE ELECTRICITY (WIRING) REGULATIONS

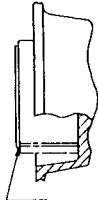

Note: Key to be flush with front of casing

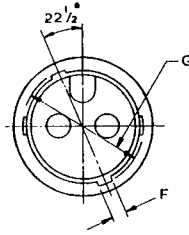

View looking at the front of the socket outlet

SOCKET OUTLET DIMENSIONS

Current rating of socket	F	G	Minimum shearing load on each key
Amperes	mm	mm	kg
5	3.96	36.91	45.4
15	3.96	43.25	45.4
30	3.96	55.96	45.4
Tolerance	—	+0 -0.13	—

**SOCKET KEY OF 5 AMPERE, 15 AMPERE AND 30 AMPERE
PROTECTED TYPE NON-REVERSIBLE SOCKET OUTLETS FOR FUSED PLUGS**

CODE No.

A3

FIGURE No.

A3(4)

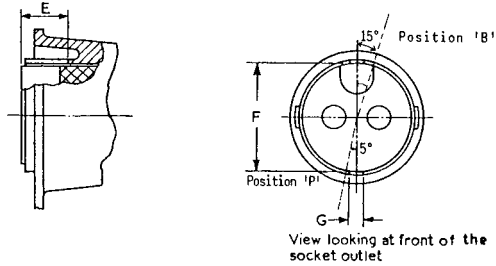

SOCKET OUTLET DIMENSIONS			
Current rating of socket	E	F	G
Amperes	mm	mm	mm
5	11.91	32.05	4.78
15	13.49	37.54	4.78
30	22.22	49.05	4.78
Tolerance	—	+0.13 —0	—

**SOCKET KEYWAYS OF 5 AMPERE, 15 AMPERE AND 30 AMPERE
PROTECTED TYPE NON-REVERSIBLE SOCKET OUTLETS FOR FUSED PLUGS**

CODE No. A3	FIGURE No. A3(5)
----------------	---------------------

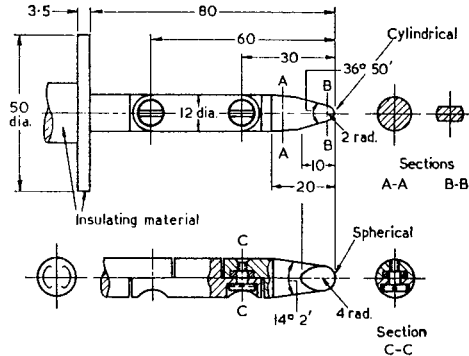

Tolerances on angles $\pm 5'$, on linear dimensions:
less than 25 mm ± 0.05 over 25 mm ± 0.2 .

All dimensions are in mm.

TEST FINGER FOR INDUSTRIAL SOCKET OUTLETS

CODE No.

A3

FIGURE No.

A3(6)

Appendix 4

Prescribed Requirements for Industrial Type 16 ampere, 32 ampere, 63 ampere and 125 ampere Socket Outlets with Retaining Devices

(1) General

A 16A or 32A or 63A or 125A socket outlet to IEC 60309 is acceptable as complying with the prescribed requirements of this appendix.

(2) Materials for plate/cover, base and current carrying parts

- (a) Parts made of ferrous metal should be rendered rust proof, special attention being given to springs and moving parts.
- (b)
 - (i) Insulating materials should be tough, non-ignitable and not soften when heated to a temperature of 100°C.
 - (ii) Current carrying parts, including earthing contact should be made of brass, copper, phosphor-bronze, and/or other suitable material.
 - (iii) The enclosure of the socket outlet should be rigid and be capable of withstanding a minimum force of 4 kg applied over an area of 250 mm² anywhere on the surface without causing appreciable damage or reducing the protective clearance below the minimum values specified in paragraph (6).

(3) Construction of socket outlet

- (a)
 - (i) The socket outlet is to be constructed to accommodate the plug having physical dimensions as detailed in Figure A4(1) and A4(2).
 - (ii) In this appendix, where reference is made to a plug, it means a plug having a corresponding rating and dimensions as detailed in Figure A4(1) and A4(2).
- (b) The configuration of the socket contacts should be as shown in Figure A4(3) and A4(4).
- (c) The essential dimensions of the socket outlets are shown in Figure A4(3) and A4(4).
- (d) Socket contacts should be self-adjusting as to contact making and each socket contact should such as to make and maintain, in normal use, effective electrical and mechanical contact with the corresponding plug pins. The means for producing the contact pressure should be associated with each socket contact independently.
- (e) Conductive component parts of the socket outlet should be so located and separated that, in normal use, they cannot be displaced so as to affect adversely the safety or proper operation of the socket outlet.

- (f) (i) Socket outlets having a rated current exceeding 32A should be splash proof or watertight.
- (ii) Sockets outlets having a rated current exceeding 63A should be watertight.
- (g) Splash proof socket outlets should be totally enclosed when fitted with screwed conduits, or lead sheathed or armoured cables and without a plug in position.
- (h) The construction of splash proof or watertight socket outlets to Figure A4(5) or Figure A4(6) are acceptable.
- (i) 63A and 125A socket outlets should have provision for an electrical interlock in the form of a pilot contact shown on Figure A4(4).
- (j) Socket outlets should be provided with a retaining device as indicated in Table A4(1).

Table A4(1)—Retaining devices

Rated Current of the Socket Outlet Amperes	Classification According to Degree of Protection against Moisture	Retaining Means	Figures Referred to
16 and 32	ordinary	lever or lid	A4(7)
	splash proof	lid	A4(7)
	watertight	two-ramp system	A4(8)
63	splash proof	lid and two-ramp system	A4(5)
	watertight	two-ramp system	A4(6)
125	watertight	two-ramp system	A4(6)

(4) Construction of terminals

- (a) Connection should be made by means of screws, nuts or equally effective devices.
- (b) Dimensions of terminals should comply with Figure A4(9) for pillar terminals, Figure A4(10) for screw terminals and stud terminals, Figure A4(11) for saddle terminals and Figure A4(12) for lug terminals.
- (c) Terminals should be effectively enclosed. Insulating barriers securely fixed to, or forming an integral part of the interiors, should be provided to separate internal metal at different potential including any bare flexible conductors, ever if such conductors should become detached from their terminals.

(5) Screws and connections

- (a) Screwed connections, electrical and otherwise should withstand the mechanical stresses occurring in normal use. Screws transmitting electrical contact pressure should screw into metal.
- (b) Screws should not be of insulating material if their replacement by a metal screw would affect the safety or performance requirements of the accessory.
- (c) Where current carrying parts are screwed together, the current path should not rely on the screw threads.
- (d) Screws and nuts for clamping the conductors should not serve to fix any other component.

(6) Creepage distances, clearances and distances through insulation

- (a) When the socket outlet is correctly assembled and wired with the appropriate cable, the minimum clearance through air and the minimum creepage distance should be 4 mm:
 - (i) between live parts of opposite polarity;
 - (ii) between live parts and any other metal parts; and
 - (iii) between live parts and the accessible external surface of the accessory.
- (b) The socket outlet should have a minimum distance of 2 mm between insulated live parts and the accessible external surface.

(7) Accessibility of live parts



Socket outlets should be so designed that when mounted and wired as in normal use, live parts are not accessible as tested by a test finger shown in Figure A3(6).

(8) Provision for earthing

- (a) The socket outlet should be so constructed with earthing contacts which should be directly connected to an internal earthing terminal.
- (b) Metalclad socket outlets should be provided with an earthing terminal intended for connection of an external earthing conductor, except for flush type socket outlets, this earthing terminal should be so arranged that the protective conductor of the cable, if any, is visible at least when the plug or appliance inlet is removed from the corresponding socket outlet.
- (c) All accessible metal parts of the socket outlet should be in effective electrical contact with the earthing contact except that metal parts on, or screws in or through, non-conducting material, and separated by such

material from current carrying parts in such a way that in normal use they cannot become live, need not be in effective electrical contact with the scraping earthing contact.

(9) Marking

- (a) The socket outlet should be legibly and durably marked with the following information, which should not be placed on screws, removable washers or other easily removable parts, or upon parts intended for separate sale:
- (i) rated current;
 - (ii) rated voltage;
 - (iii) nature of supply.
- (b) If symbols are used they should be as follows:
- | | |
|---------------------------|---|
| amperes | A |
| volts | V |
| alternating current | a.c. |
| earth | \perp or E |
| splash proof construction |  |
| watertight construction |  |
- (c) The letters R1, S2, T3 and N should be used to indicate the terminals corresponding respectively to the phase socket contacts and the neutral socket contact (N), and a symbol \perp for the earth contact. The letters and symbols should be as close as practicable to the corresponding terminals.

(10) Temperature rise

- (a) The permitted temperature rise of the accessible external surface of the socket outlet after the test of subparagraph (b) should be 50°C.
- (b) The following procedures of the test on the temperature rise of the accessible external surface of the socket outlet are acceptable:
- (i) Temperature rise of socket outlets should be measured by fine wire thermocouples.
 - (ii) The socket outlets under test should be subjected to its rated loading connected via a plug. The duration of the test is 1 hour for socket outlets having a rated current not exceeding 32A; and 2 hours for socket outlets having a rated current exceeding 32A.
- (c) Socket outlets and plugs should be mounted and connected as in normal use.

CODE OF PRACTICE FOR THE ELECTRICITY (WIRING) REGULATIONS

All dimensions are in mm.
The sketches are not intended to govern design except as regards the dimensions shown.

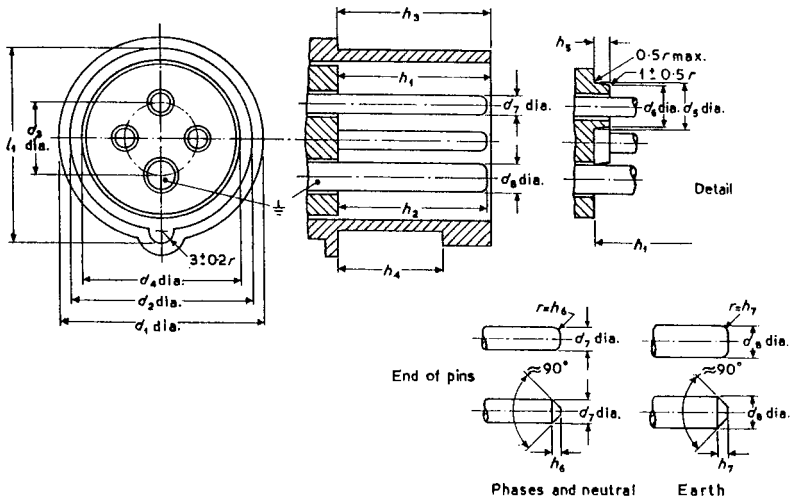

Rated current	Dimension Tolerance	d_1	$d_4^{(4)}$	d_5	d_6	$d_4^{(5)}$	$d_4^{(6)}$	d_7	d_8	h_1	h_2	h_3	h_4	$h_4^{(5)}$	h_6	h_7	$l_1^{(1)}$			
		min.	Tol.	±0.5	min.	max.	max.	+0 -0.075	+0 -0.09	+0 -1	+0 -1	+0 -1	+1 -0	max.	max.	max.	(1)	(2)	Tol.	
16	2 P + \star	47.5	43.5		17.5	37.9											46.5	47.0	1.0 -0.4	
	3 P + \star	53.5	49.5	+0 -0.6	21.5	42.8	11	10	5	7	37	36	37	24.0 ⁽¹⁾ 27.5 ⁽⁴⁾	3.5	1.7	2.2	52.9	53.6	1.0 -0.5
	3 P + N + \star	60.5	56.1		26.5	48.8												60.1	61.0	1.0 -0.6
32	2 P + \star	81.5	57.3	+0 -0.8	25.0	49.7											63.2	63.2	1.0 -0.6	
	3 P + \star	87.5	63.4		30.3	55.6	13	12	6	8	46	45	46	32.0 ⁽¹⁾ 35.5 ⁽⁴⁾	5.0	2.0	2.5	69.9	69.9	1.0 -0.7
	3 P + N + \star																			

- (1) Applicable only to ordinary or splash proof accessories.
- (2) Applicable only to watertight accessories.
- (3) Spots as shown in detail required for accessories having rated voltages exceeding 500 V, optional for other accessories.
- (4) For metal enclosures.
- (5) For enclosures of insulating material.
- (6) These dimensions shall be within the prescribed limits over the specified length.

DIMENSIONS OF 16 AMPERE AND 32 AMPERE PLUGS WITH RETAINING DEVICES

CODE No.	FIGURE No.
A4	A4(1)

CODE OF PRACTICE FOR THE ELECTRICITY (WIRING) REGULATIONS

All dimensions are in mm.
The sketches are not intended to govern design except as regards the dimensions shown.

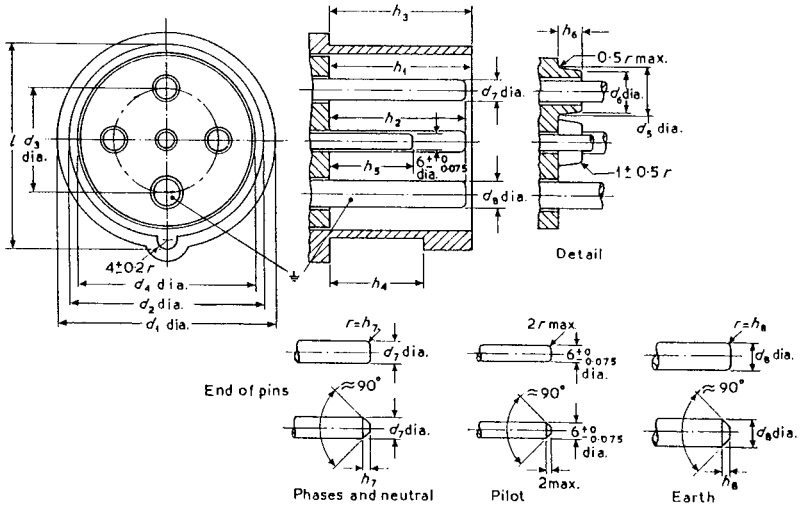

Rated current	Dimension	d_1	d_3	d_5	d_7	$d_8^{(1)}$	$d_7^{(1)}$	d_8	h_1	h_2	h_3	h_4	h_5	$h_6^{(1)}$	h_7	h_8	l	
	Tolerance	min.	+0 -0.8	±0.5	min.	max.	max.	+0 -0.09	+0 -0.11	+0 -1	+0 -1	+2 -0	+0 -1	max.	max.	max.	+0 -0.6	
A 63	2P + p + $\frac{N}{\rightarrow}$	75.5	69.5	36.5	61.5	15.8	14.3	8	10	67.0	66.0	67.0	50	29.0	8	2.5	3	75.5
125	3P + p + $\frac{N}{\rightarrow}$	87.5	81.5	42.5	72.5	20.2	18.2	10	12	74.5	69.5	75.5	58	31.5	10	3.0	4	87.5

(1) Spats as shown in detail required only for accessories having rated voltages exceeding 500 V, optional for other accessories.

DIMENSIONS OF 63 AMPERE AND 125 AMPERE PLUGS WITH RETAINING DEVICES

CODE No.	FIGURE No.
A4	A4(2)

CODE OF PRACTICE FOR THE ELECTRICITY (WIRING) REGULATIONS

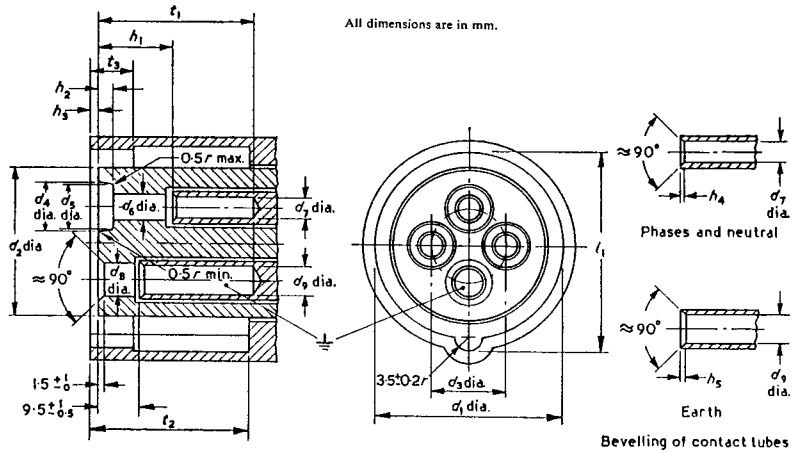

Rated Current	Dimension Tolerance	$d_1^{(*)}$	$d_2^{(*)}$	d_3	d_4	d_5	d_6	$d_7^{(*)}$	d_8	$d_9^{(*)}$	$h_1^{(*)}$	h_2	h_3	h_4	h_5	$l_1^{(*)}$	l_2	l_3	l_4	
		Tol.	+0 -1.5	±0.5	+1 -0	min.	+0.6 -0		+0.6 -0	+1 -0.5	+3 -0	+0 -1	max.	max.	+0.5 -0	min.	min.	min.	min.	
16	2 P + \star	44.3	+0.4 -0	36	17.5											47.5				
	3 P + \star	50.4	+0.5 -0	40.8	21.5	11.6	11	6	5	8.0	7	19.5	3.8	2	0.8	1.2	54.0	37	38	10
	3 P + N + \star	57.3	+0.6 -0	46.4	26.5												61.3			
32	2 P + \star																			
	3 P + \star	58.6	+0.6 -0	47	25.0	13.6	13	7	6	9.1	8	21.5	5.3	3	1.0	1.5	64.6	45	48	15
	3 P + N + \star	64.7	+0.6 -0	52.9	30.3												71.2			

- (1) The dimension d_4 shall be within the prescribed limits over the distance l_4 .
- (2) The dimensions d_4 and l_4 shall be within the prescribed limits over the distance l_4 . Beyond this, they may be larger but not smaller.
- (3) For type 3 P + N + \star the dimension h_1 is 16.0 mm for the neutral.
- (4) The contact tubes should be suitable for pins of the specified diameters.

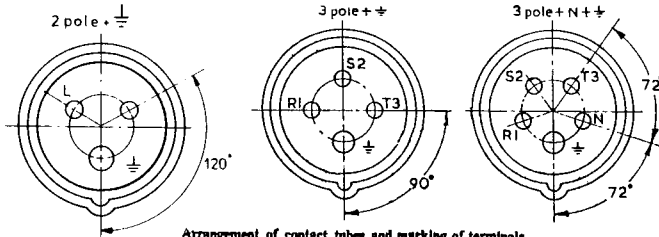

Arrangement of contact tubes and marking of terminals.
Front view of contact tubes of socket-outlet or connector

CONFIGURATION OF SOCKET CONTACTS AND DIMENSIONS OF
16 AMPERE AND 32 AMPERE SOCKET OUTLET WITH RETAINING DEVICES

CODE No.	FIGURE No.
A4	A4(3)

CODE OF PRACTICE FOR THE ELECTRICITY (WIRING) REGULATIONS

All dimensions are in mm.

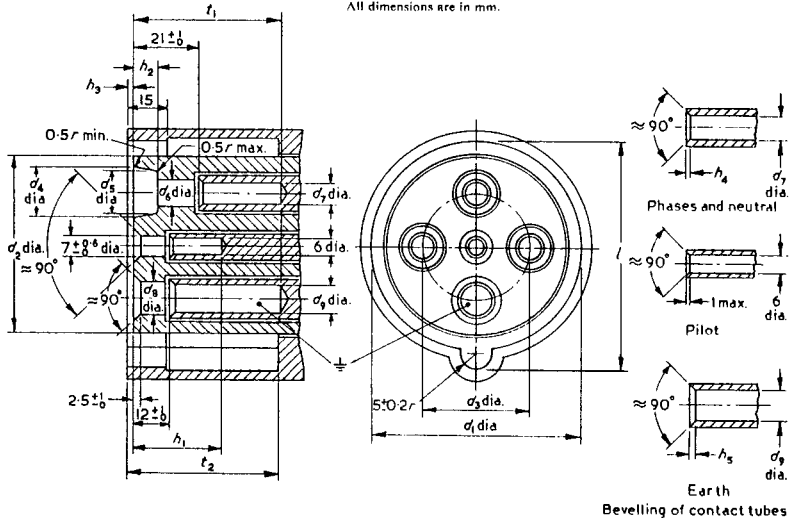

Beveling of contact tubes

Rated current	Dimension	$d_1(t)$	$d_4(t)$	d_5	d_6	d_7	d_8	d_9	d_{10}	h_1	h_2	h_3	h_4	h_5	$l(t)$	t_1	t_2	
		Tolerance	+0.8 -0	+0 -1.5	± 0.5	+1 -0	min.	+0.6 -0			min.	+1.3 -1	+0	max.	max.	+0.6 -0	min.	min.
63	2P + p + $\frac{1}{2}$ 3P + p + $\frac{1}{2}$	71	60	36.5	16.6	15.1	9.0	8	11.5	10	30	8	2.5	1.5	2.0	17.5	67	69
125	3P + p + N + $\frac{1}{2}$	83	71	42.5	21.0	19.0	11.5	10	14.0	12	32	10	4.0	2.0	2.5	19.5	71	76

- (1) The dimension d_4 shall be within the prescribed limits over the distance t_1 .
 (2) The dimensions d_4 and l shall be within the prescribed limits over a distance of 15 mm. Beyond this, they may be larger but not smaller.
 (3) The contact tubes shall be suitable for pins of the specified diameters.

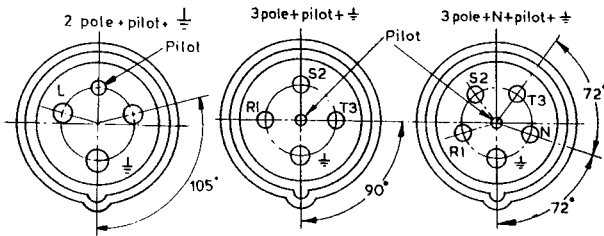

Arrangement of contact tubes and marking of terminals.
 Front view of contact tubes of socket-outlet or connectors.

**CONFIGURATION OF SOCKET CONTACTS AND DIMENSIONS OF
 63 AMPERE AND 125 AMPERE SOCKET OUTLETS WITH RETAINING DEVICES**

CODE No.	FIGURE No.
A4	A4(4)

All dimensions are in mm

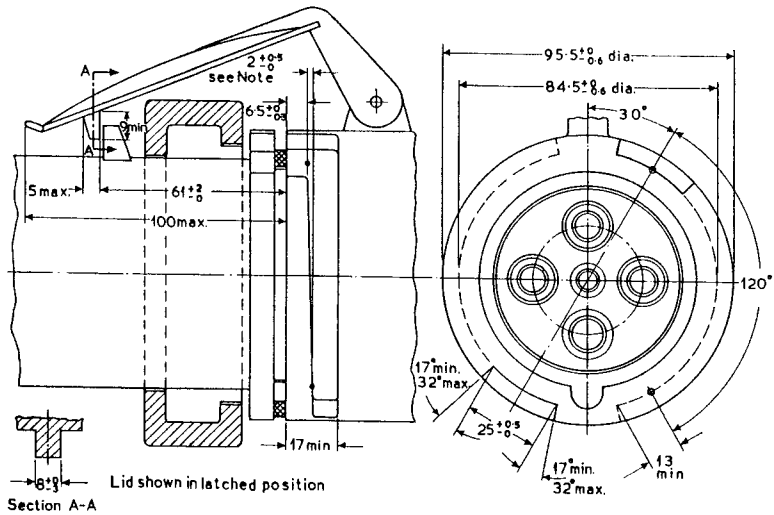

Note : The inclination of the ramp shall be such that this dimension refers to the angle of 120° shown.

**CONSTRUCTION OF 63 AMPERE SPLASH PROOF SOCKET OUTLET
WITH RETAINING DEVICE**

CODE No. A4	FIGURE No. A4(5)
----------------	---------------------

CODE OF PRACTICE FOR THE ELECTRICITY (WIRING) REGULATIONS

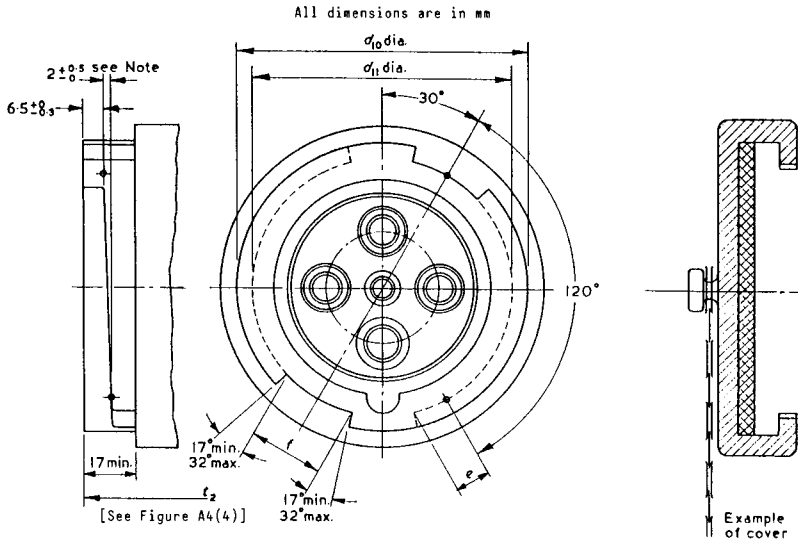

Rated current	Dimension	d ₁₀	d ₁₁	e	f
	Tolerance	+0 -0.6	+0 -0.6	min.	+0.5 -0
A 63	2 P + p + $\frac{\phi}{2}$	95.5	84.5	13	25
	3 P + p + $\frac{\phi}{2}$				
125	3 P + p + N + $\frac{\phi}{2}$	108.5	97.5	16	30

Note: The inclination of the ramps shall be such that this dimension refers to the angle of 120° shown.

**CONSTRUCTION OF 63 AMPERE AND 125 AMPERE WATERTIGHT
SOCKET OUTLETS WITH RETAINING DEVICES**

CODE No. A4 FIGURE No. A4(6)

CODE OF PRACTICE FOR THE ELECTRICITY (WIRING) REGULATIONS

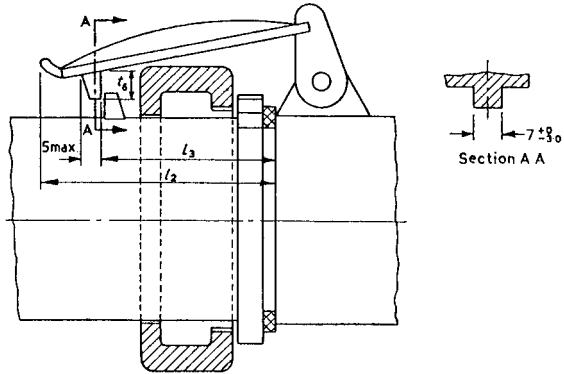

Rated current	Dimension	l_1	l_3		t_4
	Tolerance	max.		Tol.	min.
16	2 P + \uparrow	70	41.5	+1.5 -0	5
	3 P + \uparrow	75	47.5		5
	3 P + N + \uparrow	85	53.5		6
32	2 P + \uparrow	85	54.5	+1.5 -0	6
	3 P + \uparrow				
	3 P + N + \uparrow	100	60.5	+2 -0	7

All dimensions are in mm

LEVEL OR LID FOR 16 AMPERE AND 32 AMPERE
SOCKET OUTLETS WITH RETAINING DEVICES

CODE No.	FIGURE No.
A4	A4(7)

CODE OF PRACTICE FOR THE ELECTRICITY (WIRING) REGULATIONS

All dimensions are in mm

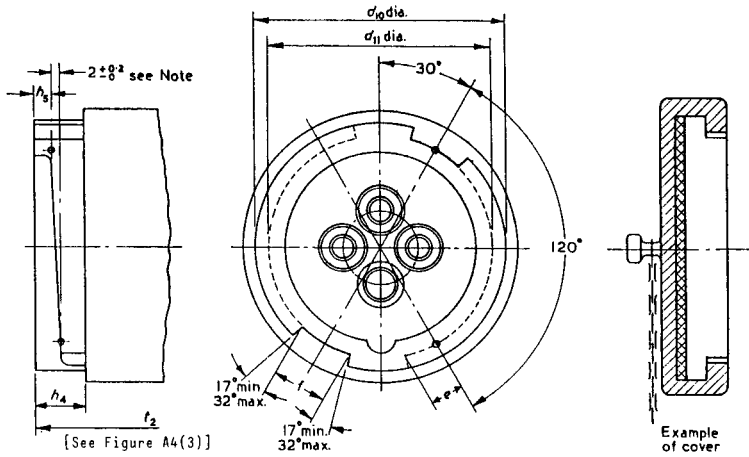

Rated current	Dimension	d_{10}	d_{11}	e	f	h_4	h_5
	Tolerance	+0 -0.5	+0 -0.5	min.	+0.5 -0	min.	+0 -0.2
A	2 P + ✦	60	53	8	13		
16	3 P + ✦	68	60	10	17	12	4.2
	3 P + N + ✦	76	68	12	20		
32	2 P + ✦	82	72	12	20	14	6.2
	3 P + ✦						
	3 P + N + ✦	89	79	15	23		

Note: The inclination of the ramps shall be such that this dimension refers to the angle of 120° shown.

**TWO-RAMP SYSTEM FOR 16 AMPERE AND 32 AMPERE
SOCKET OUTLETS WITH RETAINING DEVICES**

CODE No.	FIGURE No.
A4	A4(8)

CODE OF PRACTICE FOR THE ELECTRICITY (WIRING) REGULATIONS

All dimensions are in mm.

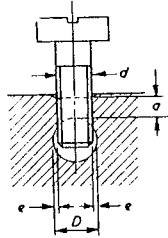

Terminal without pressure plate

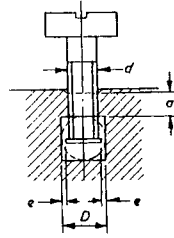

Terminal with pressure plate

Terminal size	Minimum diameter of conductor space D	Minimum nominal thread diameter d		Maximum gap between conductor restraining parts e	Minimum length of thread in terminal a		Minimum distance between clamping screw and end of conductor when fully inserted	
		One screw	Two screws		One screw	Two screws	One screw	Two screws
2	3.0	3.0 [†]	2.5	0.5	2.0	1.8	1.5	1.5
3	3.6	3.5	2.5 [†]	0.5	2.5	1.8	1.8	1.5
4	4.0	3.5	3.0 [†]	0.6	2.5	2.0	1.8	1.5
5	4.5	4.0	3.0 [†]	1.0	3.0	2.0	2.0	1.5
6	5.5	5.0	4.0	1.3	4.0	3.0	2.5	2.0
7	7.0	6.0	4.0	1.5	4.0	3.0	3.0	2.0
8	8.0	—	6.0	—	—	4.5	—	3.0
9	12	—	10	—	—	7.5	—	—
10	16	—	—	—	—	—	—	—

DIMENSIONS OF PILLAR TERMINALS FOR SOCKET OUTLET WITH RETAINING DEVICE

CODE No. A4 FIGURE No. A4(9)

CODE OF PRACTICE FOR THE ELECTRICITY (WIRING) REGULATIONS

All dimensions are in mm.

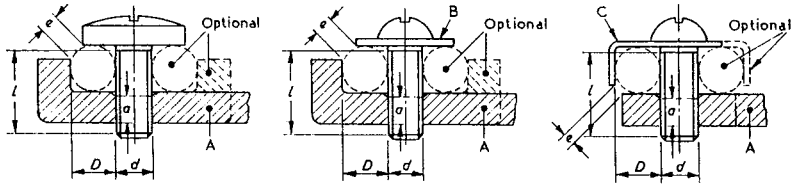

Screw not requiring washer or clamping plate

Screw requiring washer or clamping plate

Screw terminals

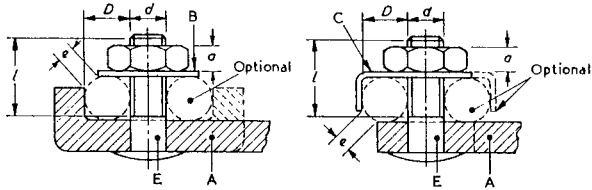

Stud terminals

A Fixed part.
B Washer or clamping plate.

C Anti-spread device.
E Stud.

Terminal size	Minimum diameter of conductor space <i>D</i>	Minimum nominal thread diameter <i>d</i>		Maximum gap between conductor restraining parts <i>e</i>	Minimum length of thread in fixed part or nut <i>a</i>		Minimum length of thread on screw or stud <i>l</i>
		One screw	Two screws		One screw	Two screws	
2	2.0	3.5	—	1.5	1.5	—	4.0
3	2.7	4.0	3.0 ¹	1.5	2.5	1.5	5.5
4	3.6	5.0	4.0	1.5	3.0	2.5	6.5
5	4.3	5.0	4.0	2.0	3.0	2.5	7.5
6	5.5	5.0	4.0	2.0	3.5	2.5	9.0
7	7.0	6.0	5.0	2.0	3.5	3.0	10.5
8	8.0	6.0	5.0	2.0	4.0	3.0	12.0
9	—	8.0	—	—	5.5	—	14.0
10	—	10.0	—	—	7.0	—	16.0

**DIMENSIONS OF SCREW TERMINALS AND STUD TERMINALS
FOR SOCKET OUTLET WITH RETAINING DEVICE**

CODE No.	FIGURE No.
A4	A4(10)

CODE OF PRACTICE FOR THE ELECTRICITY (WIRING) REGULATIONS

All dimensions are in mm.

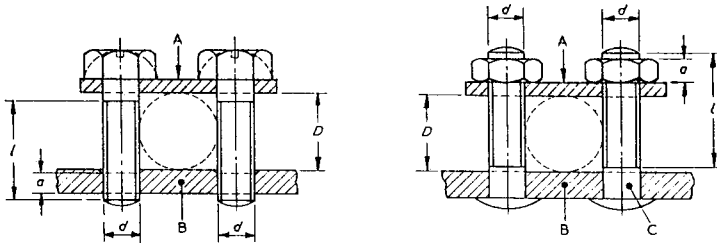

A Saddle.
B Fixed part.
C Stud.

Terminal size	Minimum diameter of conductor space <i>D</i>	Minimum nominal thread <i>d</i>	Minimum length of thread in fixed part or nut <i>a</i>	Minimum length of thread on screws or studs <i>l</i>
3	3.0	3.0 ¹	1.5	5.0
4	4.0	3.5	1.5	6.0
5	4.5	4.0	2.5	7.0
6	5.5	4.0	2.5	8.0
7	7.0	5.0	3.0	10.0

DIMENSIONS OF SADDLE TERMINALS FOR SOCKET OUTLET
WITH RETAINING DEVICE

CODE No.	FIGURE No.
A4	A4(11)

CODE OF PRACTICE FOR THE ELECTRICITY (WIRING) REGULATIONS

All dimensions are in mm.

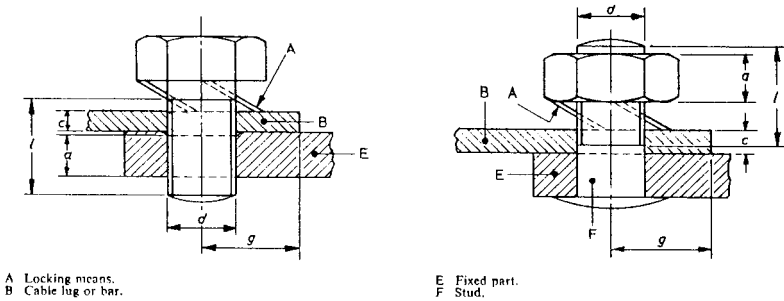

A Locking means.
B Cable lug or bar.

E Fixed part.
F Stud.

Terminal size	Minimum nominal thread diameter	Minimum length of thread on fixed part or nut	Minimum length of thread on screw or stud	Maximum thickness of lug or bar to be accommodated	Minimum distance from centre of screw or hole to side of rectangular clamping area
	<i>d</i>	<i>a</i>	<i>l</i>	<i>c</i>	<i>g</i>
6	5.0	3.0	10	6.0	10
7	6.0	3.5	12	8.0	12

DIMENSIONS OF LUG TERMINALS FOR
SOCKET OUTLET WITH RETAINING DEVICE

CODE No. A4 FIGURE No. A4(12)

Appendix 5

Rating Factors for Sizing of Cable Conductors

(1) Rating factors for ambient temperature

Table A5(1)

Rating factors for ambient temperature

Ambient temperature °C	Type of insulation				
	60°C thermosetting	70°C thermoplastic	90°C Thermosetting	Mineral *	
				Thermoplastic covered or bare and exposed to touch 70°C	Bare and not exposed to touch 105°C
25	1.04	1.03	1.02	1.07	1.04
30	1.00	1.00	1.00	1.00	1.00
35	0.91	0.94	0.96	0.93	0.96
40	0.82	0.87	0.91	0.85	0.92
45	0.71	0.79	0.87	0.78	0.88
50	0.58	0.71	0.82	0.67	0.84
55	0.41	0.61	0.76	0.57	0.80
60	–	0.50	0.71	0.45	0.75
65	–	–	0.65	–	0.70
70	–	–	0.58	–	0.65
75	–	–	0.50	–	0.60
80	–	–	0.41	–	0.54
85	–	–	–	–	0.47
90	–	–	–	–	0.40
95	–	–	–	–	0.32

*For higher ambient temperature, please consult manufacturer.

Table A5(2)

(Reserved for Future Uses)

(2) Rating factors for groups of cables

Table A5(3)

Rating factors for one circuit or one multi-core cable, or for a group of circuits, or a group of multi-core cables, to be used with current-carrying capacities of Table A6(1) to A6(8)

Item	Arrangement (cable touching)	Number of circuits or multicore cables												To be used with current- carrying capacities, Reference Method
		1	2	3	4	5	6	7	8	9	12	16	20	
1.	Bunched in air, on a surface, embedded or enclosed	1.00	0.80	0.70	0.65	0.60	0.57	0.54	0.52	0.50	0.45	0.41	0.38	A to F
2.	Single layer on wall or floor	1.00	0.85	0.79	0.75	0.73	0.72	0.72	0.71	0.70	0.70	0.70	0.70	C
3.	Single layer multi-core on a perforated horizontal or vertical cable tray system	1.00	0.88	0.82	0.77	0.75	0.73	0.73	0.72	0.72	0.72	0.72	0.72	E and F
4.	Single layer multicore on cable ladder system or cleats, etc.	1.00	0.87	0.82	0.80	0.80	0.79	0.79	0.78	0.78	0.78	0.78	0.78	E and F

Notes to Table A5(3)

- 1: These factors are applicable to uniform groups of cable, equally loaded.
- 2: Where horizontal clearances between adjacent cables exceed twice their overall diameter, no rating factor need be applied.
- 3: The same factors are applied to:
 - groups of two or three single-core cables;
 - multicore cables
- 4: If a group consists of both two- and three-core cables, the total number of cables is taken as the number of circuits, and the corresponding factor is applied to the tables for two loaded conductors for the two-core cables, and to the Tables for three loaded conductors for the three-core cables.
- 5: If a group consists of n single-core cables it may either be considered as n/2 circuits of two loaded conductors or n/3 circuits of three loaded conductors
- 6: The rating factors given have been averaged over the range of conductor sizes and types of installation included in BS 7671 and the overall accuracy of tabulated values is within 5%.
- 7: Where cables having differing conductor operating temperature are grouped together, the current rating is to be based upon the lowest operating temperature of any cable in the group.
- 8: If, due to known operating conditions, a cable is expected to carry not more than 30% of its grouped rating, it may be ignored for the purpose of obtaining the rating factor for the rest of the group.
 For example, a group of N loaded cables would normally require a group rating factor of C_g applied to the tabulated I_c .
 However, if M cables in the group carry loads which are not greater than $0.3 C_g I_c$ amperes the other cables can be sized by using the group rating factor corresponding to (N-M) cables.

(3) Correction factors for cables enclosed in thermal insulating material

For a cable installed in a thermally insulated wall or above a thermally insulated ceiling, the cable being in contact with a thermally conductive surface on one side, current carrying capacities are tabulated in Appendix 6, Method 4 of Appendix 7 being the appropriate Reference Method.

For a single cable likely to be totally surrounded by thermally insulating material over a length of more than 0.5m, the current carrying capacity shall be taken, in the absence of more precise information, as 0.5 times the current carrying capacity for that cable clipped direct to a surface and open (Reference Method 1 of Appendix 7).

Where a cable is to be totally surrounded by thermal insulation for less than 0.5 m the current carrying capacity of the cable shall be reduced appropriately depending on the size of cable, length in insulation and thermal properties of the insulation. The derating factors in Table A5(4) are appropriate to conductor size up to 10 mm² in thermal insulation having a thermal conductivity greater than 0.04 W/K.m.

Table A5(4)

Cable surrounded by thermal insulation

length in insulation mm	derating factor
50	0.88
100	0.78
200	0.63
400	0.51

(4) Correction factors for the type of protective devices protecting the cable

Table A5(5)

Correction Factors for Type of Protective Devices

Type of Protective Device	Correction Factor
Semi-enclosed fuse to BS 3036	0.725
Others	1.0

(5) Rating factors for cable enclosed in infloor concrete troughs

Table A5(6)

*Rating factors for cables enclosed in infloor concrete troughs
(Installation Methods 118, 119 and 120 of Appendix 7)* ^{Notes}

The rating factors tabulated below relate to the disposition of cables illustrated in items 118 to 120 of Appendix 7 and are applicable to the current-carrying capacities for Reference Methods E & F as given in the relevant tables of Appendix 6.

Rating Factors

Conductor cross-sectional area	Installation Method 118				Installation Method 119			Installation Method 120		
	2 single-core cables, or 1 three- or four-core cable	3 single-core cables, or 2 two-core cables	4 single-core cables, or 2 three- or four-core cables	6 single-core cables, 4 two-core cables, or 3 three- or four-core cables	6 single-core cables, 4 two-core cables, or 3 three- or four-core cables	8 single-core cables, or 4 three- or four-core cables	12 single-core cables, 8 two-core cables, or 6 three- or four-core cables	12 single-core cables, 8 two-core cables, or 6 three- or four-core cables	18 single-core cables, 12 two-core cables, or 9 three- or four-core cables	24 single-core cables, 16 two-core cables, or 12 three- or four-core cables
mm ²										
4	0.93	0.90	0.87	0.82	0.86	0.83	0.76	0.81	0.74	0.69
6	0.92	0.89	0.86	0.81	0.86	0.82	0.75	0.80	0.73	0.68
10	0.91	0.88	0.85	0.80	0.85	0.80	0.74	0.78	0.72	0.66
16	0.91	0.87	0.84	0.78	0.83	0.78	0.71	0.76	0.70	0.64
25	0.90	0.86	0.82	0.76	0.81	0.76	0.69	0.74	0.67	0.62
35	0.89	0.85	0.81	0.75	0.80	0.74	0.68	0.72	0.66	0.60
50	0.88	0.84	0.79	0.74	0.78	0.73	0.66	0.71	0.64	0.59
70	0.87	0.82	0.78	0.72	0.77	0.72	0.64	0.70	0.62	0.57
95	0.86	0.81	0.76	0.70	0.75	0.70	0.63	0.68	0.60	0.55
120	0.85	0.80	0.75	0.69	0.73	0.68	0.61	0.66	0.58	0.53
150	0.84	0.78	0.74	0.67	0.72	0.67	0.59	0.64	0.57	0.51
185	0.83	0.77	0.73	0.65	0.70	0.65	0.58	0.63	0.55	0.49
240	0.82	0.76	0.71	0.63	0.69	0.63	0.56	0.61	0.53	0.48
300	0.81	0.74	0.69	0.62	0.68	0.62	0.54	0.59	0.52	0.46
400	0.80	0.73	0.67	0.59	0.66	0.60	0.52	0.57	0.50	0.44
500	0.78	0.72	0.66	0.58	0.64	0.58	0.51	0.56	0.48	0.43
630	0.77	0.71	0.65	0.56	0.63	0.57	0.49	0.54	0.47	0.41

Notes to Table A5(6)

- 1: The factors in Table A5(6) are applicable to groups of cables all of one size. The value of current derived from application of the appropriate factors is the maximum current to be carried by any of the cables in the group.
- 2: If, due to known operating conditions, a cable is expected to carry not more than 30% of its grouped rating, it may be ignored for the purpose of obtaining the rating factor for the rest of the group.
- 3: Where cables having differing conductor operating temperature are grouped together, the current rating is to be based upon the lowest operating temperature of any cable in the group.
- 4: When the number of cables used differs from those stated in the table, the rating factor for the next higher stated number of cables should be used.

Appendix 6

Current Carrying Capacities and Voltage Drop Tables for PVC Insulated and XLPE Insulated Cables

- (Note: 1. For cable types other than PVC insulated or XLPE insulated cables, tables of current carrying capacities and voltage drop can be obtained in BS 7671.
2. PVC insulated cables are also known as 70°C thermoplastic insulated cables.
3. XLPE insulated cables are also known as 90°C thermosetting insulated cables.)

1. Tables of current carrying capacities

- (a) The tabulated current carrying capacities relate to continuous loading of cables in single circuit with the installation methods shown in Appendix 7. The values correspond to the conductor operating temperatures indicated in the headings of the tables and for a.c. operation apply only to frequencies in the range 49 to 61 Hz.
- (b) The values of current tabulated represent current carrying capacities where no correction factor is applied. Under individual installation conditions, appropriate correction factors (see Appendix 5) for ambient temperature, grouping and thermal insulation etc. should be applied as multipliers to the tabulated values.

2. Tables of voltage drop

- (a) In the Tables, values of voltage drop are given for a current of one ampere for a metre run and represent the result of the voltage drops in all the circuit conductors. The values of voltage drop assume that the conductors are at their maximum permitted normal operating temperatures. For a.c. operation, the tabulated values apply only to frequencies in the range 49 to 61 Hz and for armoured cables, the values apply where the armour is bonded.
- (b) For cables having conductors cross-sectional area of 16 mm² or less, inductance can be ignored and only the resistive component (mV/A/m)_r, values are tabulated. For cables having conductors cross-sectional area greater than 16 mm², the impedance values are given as (mV/A/m)_z, together with the resistive component (mV/A/m)_r and the reactive component (mV/A/m)_x.

This page is intentionally left blank

TABLE A6(1)

Single-core PVC insulated cables, non-armoured, with or without sheath
(COPPER CONDUCTORS)

BS 6004

BS EN 50525-2-31

Ambient temperature: 30°C

Conductor operating temperature: 70°C

CURRENT CARRYING CAPACITY (Amperes):

Conductor cross-sectional area	Reference Method A (enclosed in conduit in thermally insulating wall, etc.)		Reference Method B (enclosed in conduit on a wall or in trunking, etc.)		Reference Method C (clipped direct)		Reference Method F (in free air or on a perforated cable tray horizontal or vertical)					
	2 cables, single-phase a.c. or d.c.		3 or 4 cables, three-phase a.c.		2 cables, single-phase a.c. or d.c. flat and touching		3 or 4 cables, three-phase a.c. flat and trefoil		Touching		Spaced by one diameter	
	2	3	4	5	6	7	8	9	10	Horizontal	Vertical	
1	A	A	A	A	A	A	A	A	A	A	A	A
mm ²												
1	11	10.5	13.5	12	15.5	14	131	146	110	146	130	130
1.5	14.5	13.5	17.5	15.5	20	18	162	181	137	181	162	162
2.5	20	18	24	21	27	25	196	219	167	219	197	197
4	26	24	32	28	37	33	251	281	216	281	254	254
6	34	31	41	36	47	43	304	341	264	341	311	311
10	46	42	57	50	65	59	352	396	308	396	362	362
16	61	56	76	68	87	79	406	456	356	456	419	419
25	80	73	101	89	114	104	463	521	409	521	480	480
35	99	89	125	110	141	129	546	615	485	615	569	569
50	119	108	151	134	182	167	629	709	561	709	659	659
70	151	136	192	171	234	214	754	852	656	852	795	795
95	182	164	232	207	284	261	868	982	749	982	920	920
120	210	188	269	239	330	303	1005	1138	855	1138	1070	1070
150	240	216	300	262	381	349	1086	1216	911	1216	1188	1188
185	273	245	341	296	436	400	1154	1337	1079	1337	1337	1337
240	321	286	400	346	515	472						
300	367	328	458	394	594	545						
400	-	-	546	467	694	634						
500	-	-	626	533	792	723						
630	-	-	720	611	904	826						
800	-	-	-	-	1030	943						
1000	-	-	-	-	1154	1058						

TABLE A6(1) (Cont.)

VOLTAGE DROP (per ampere per metre):

Conductor operating temperature: 70°C

Conductor cross-sectional area	2 cables, d.c.			2 cables --- single-phase a.c.						3 or 4 cables --- three-phase a.c.								
	Reference Methods A&B (enclosed in conduit or trunking)			Reference Methods C & F (clipped direct, on tray or in free air)			Reference Methods C & F (clipped direct, on tray or in free air)			Reference Methods A & B (enclosed in conduit or trunking)			Reference Methods C & F (clipped direct, on tray or in free air)					
	Cables touching			Cables spaced *			Cables touching			Cables touching			Cables touching, Flat			Cables spaced *, Flat		
	mV			mV			mV			mV			mV			mV		
1	2	3	4	5	6	7	8	9										
mm ²		mV	mV	mV	mV	mV	mV	mV	mV	mV	mV	mV	mV	mV	mV	mV	mV	mV
1	44	44	44	44	44	44	44	44	38	38	38	38	38	38	38	38	38	38
1.5	29	29	29	29	29	29	29	29	25	25	25	25	25	25	25	25	25	25
2.5	18	18	18	18	18	18	18	18	15	15	15	15	15	15	15	15	15	15
4	11	11	11	11	11	11	11	11	9.5	9.5	9.5	9.5	9.5	9.5	9.5	9.5	9.5	9.5
6	7.3	7.3	7.3	7.3	7.3	7.3	7.3	7.3	6.4	6.4	6.4	6.4	6.4	6.4	6.4	6.4	6.4	6.4
10	4.4	4.4	4.4	4.4	4.4	4.4	4.4	4.4	3.8	3.8	3.8	3.8	3.8	3.8	3.8	3.8	3.8	3.8
16	2.8	2.8	2.8	2.8	2.8	2.8	2.8	2.8	2.4	2.4	2.4	2.4	2.4	2.4	2.4	2.4	2.4	2.4
25	1.75	1.80	0.33	1.80	1.75	0.20	1.75	0.29	1.55	1.5	0.175	1.50	0.25	1.55	1.50	0.32	1.55	1.50
35	1.25	1.30	0.31	1.30	1.25	0.195	1.25	0.28	1.10	1.10	0.170	1.10	0.24	1.10	1.10	0.32	1.15	1.10
50	0.93	0.95	0.30	1.00	0.93	0.190	0.95	0.28	0.85	0.80	0.165	0.82	0.24	0.84	0.80	0.32	0.86	0.80
70	0.63	0.65	0.29	0.72	0.63	0.185	0.66	0.27	0.61	0.55	0.160	0.57	0.24	0.60	0.55	0.31	0.63	0.55
95	0.46	0.49	0.28	0.56	0.47	0.180	0.50	0.27	0.54	0.41	0.155	0.43	0.23	0.47	0.40	0.31	0.51	0.40
120	0.36	0.39	0.27	0.47	0.37	0.175	0.41	0.26	0.45	0.33	0.25	0.41	0.23	0.40	0.32	0.30	0.44	0.32
150	0.29	0.31	0.27	0.41	0.30	0.170	0.34	0.29	0.39	0.27	0.23	0.36	0.26	0.34	0.26	0.30	0.40	0.26
185	0.23	0.25	0.27	0.37	0.24	0.170	0.29	0.24	0.35	0.22	0.23	0.32	0.21	0.31	0.21	0.30	0.36	0.21
240	0.180	0.195	0.26	0.33	0.185	0.165	0.25	0.185	0.25	0.17	0.23	0.29	0.160	0.22	0.160	0.29	0.34	0.160
300	0.145	0.160	0.26	0.31	0.150	0.165	0.22	0.150	0.25	0.14	0.23	0.27	0.130	0.22	0.130	0.29	0.32	0.130
400	0.105	0.130	0.26	0.29	0.120	0.160	0.20	0.115	0.25	0.12	0.22	0.25	0.105	0.21	0.105	0.29	0.31	0.100
500	0.086	0.110	0.26	0.28	0.098	0.155	0.185	0.093	0.24	0.26	0.10	0.22	0.086	0.21	0.086	0.29	0.30	0.081
630	0.068	0.094	0.25	0.27	0.081	0.155	0.175	0.076	0.24	0.25	0.08	0.22	0.072	0.21	0.072	0.28	0.29	0.066
800	0.053	0.075	0.25	0.27	0.068	0.150	0.165	0.061	0.24	0.25	0.055	0.21	0.060	0.21	0.060	0.28	0.29	0.053
1000	0.042	0.055	0.25	0.27	0.059	0.150	0.160	0.050	0.24	0.24	0.052	0.21	0.052	0.21	0.052	0.28	0.28	0.044

NOTE: * Spacings larger than one cable diameter will result in a larger voltage drop.

TABLE A6(2)
Multicore PVC insulated cables, non-armoured
(COPPER CONDUCTORS)

BS 6004
 BS 7629-1
 BS 8436

Ambient temperature: 30°C
 Conductor operating temperature: 70°C

CURRENT CARRYING CAPACITY (Amperes):

Conductor cross-sectional area	Reference Method A (enclosed in conduit in thermally insulating wall etc.)		Reference Method B (enclosed in conduit on a wall or in trunking etc.)		Reference Method C (clipped direct)		Reference Method E (in free air or on a perforated cable tray, etc, horizontal or vertical)	
	1 two-core cable*, single-phase a.c. or d.c.	3 three-core cable or 1 four-core cable*, three-phase a.c.	1 two-core cable*, single-phase a.c. or d.c.	1 three-core cable or 1 four-core cable*, three-phase a.c.	1 two-core cable*, single-phase a.c. or d.c.	1 three-core cable or 1 four-core cable*, three-phase a.c.	1 two-core cable*, single-phase a.c. or d.c.	1 three-core cable or 1 four-core cable*, three-phase a.c.
1	2	3	4	5	6	7	8	9
mm ²	A	A	A	A	A	A	A	A
1	11	10	13	11.5	15	13.5	17	14.5
1.5	14	13	16.5	15	19.5	17.5	22	18.5
2.5	18.5	17.5	23	20	27	24	30	25
4	25	23	30	27	36	32	40	34
6	32	29	38	34	46	41	51	43
10	43	39	52	46	63	57	70	60
16	57	52	69	62	85	76	94	80
25	75	68	90	80	112	96	119	101
35	92	83	111	99	138	119	148	126
50	110	99	133	118	168	144	180	153
70	139	125	168	149	213	184	232	196
95	167	150	201	179	258	223	282	238
120	192	172	232	206	299	259	328	276
150	219	196	258	225	344	299	379	319
185	248	223	294	255	392	341	434	364
240	291	261	344	297	461	403	514	430
300	334	298	394	339	530	464	593	497
400	—	—	470	402	634	557	715	597

NOTE: *With or without protective conductor

TABLE A6(2) (Cont.)

VOLTAGE DROP (per ampere per metre):

Conductor operating temperature: 70°C

Conductor cross-sectional area 1	Two-core cable d.c. 2	Two-core cable single phase a.c. 3	Three-or four-core cable three phase a.c. 4
mm ²	mV	mV	mV
1	44	44	38
1.5	29	29	25
2.5	18	18	15
4	11	11	9.5
6	7.3	7.3	6.4
10	4.4	4.4	3.8
16	2.8	2.8	2.4
25	1.75	1.75	1.50
35	1.25	1.25	1.10
50	0.93	0.93	0.80
70	0.63	0.63	0.55
95	0.46	0.47	0.41
120	0.36	0.38	0.33
150	0.29	0.30	0.26
185	0.23	0.25	0.21
240	0.180	0.190	0.165
300	0.145	0.155	0.135
400	0.105	0.115	0.100
		r	r
		x	x
		z	z
		1.75	1.50
		1.25	1.10
		0.94	0.81
		0.65	0.57
		0.50	0.43
		0.41	0.35
		0.34	0.29
		0.29	0.25
		0.24	0.21
		0.21	0.185
		0.185	0.160

TABLE A6(3)

Single-core armoured PVC insulated cables
(non-magnetic armour)
(COPPER CONDUCTORS)

BS 6346

CURRENT CARRYING CAPACITY (Amperes):

Ambient temperature: 30°C
Conductor operating temperature: 70°C

Conductor cross-sectional area	Reference Method C (clipped direct)				Reference Method F (in free air or on a perforated cable tray horizontal or vertical)							
	Touching				Touching		Spaced by one diameter		Spaced by one diameter		Spaced by one diameter	
	2 cables, single-phase a.c. or d.c. flat	3 or 4 cables, three-phase a.c. flat	2 cables, single-phase a.c. or d.c. flat	3 cables, three-phase a.c. flat	3 cables, three-phase a.c. flat	3 cables, three-phase a.c. trefoil	2 cables, d.c.	2 cables, d.c.	2 cables, single-phase a.c.	2 cables, single-phase a.c.	3 or 4 cables, three-phase a.c.	3 or 4 cables, three-phase a.c.
1	2	3	4	5	6	7	8	9	10	11	12	
mm ²	A	A	A	A	A	A	A	A	A	A	A	A
50	193	179	205	189	181	229	216	229	217	230	212	A
70	245	225	259	238	231	294	279	287	272	286	263	A
95	296	269	313	285	280	357	340	349	332	338	313	A
120	342	309	360	327	324	415	396	401	393	385	357	A
150	393	352	413	373	373	479	458	449	429	436	405	A
185	447	399	469	422	425	548	525	511	489	490	456	A
240	525	465	550	492	501	648	622	593	568	566	528	A
300	594	515	624	547	567	748	719	668	640	616	578	A
400	687	575	723	618	657	885	851	737	707	674	632	A
500	763	622	805	673	731	1035	997	810	777	721	676	A
630	843	669	891	728	728	1218	1174	893	856	771	723	A
800	919	710	976	777	777	1441	1390	943	905	824	772	A
1000	978	737	1041 ¹	808	808	1685	1627	1008	967	872	816	A

TABLE A6(3) (Cont.)

VOLTAGE DROP (per ampere per metre):

Conductor operating temperature: 70°C

Conductor cross-sectional area	Reference Methods C & F (clipped direct, on tray or in free air)																	
	2 cables, single-phase a.c.						3 or 4 cables, three-phase a.c.											
	touching			spaced *			Trefoil and touching			flat and touching			flat and spaced *					
1	2			3			4			5			6			7		
mm ²	mV			mV			mV			mV			mV			mV		
50	0.93	0.22	0.95	0.92	0.30	0.97	0.80	0.190	0.82	0.79	0.26	0.84	0.79	0.26	0.84	0.79	0.34	0.86
70	0.63	0.21	0.68	0.66	0.29	0.72	0.56	0.180	0.58	0.57	0.25	0.62	0.57	0.25	0.62	0.59	0.32	0.68
95	0.46	0.20	0.52	0.51	0.28	0.58	0.42	0.175	0.45	0.44	0.25	0.50	0.47	0.25	0.50	0.47	0.31	0.57
120	0.36	0.195	0.43	0.42	0.28	0.50	0.33	0.170	0.37	0.36	0.24	0.43	0.40	0.24	0.43	0.40	0.30	0.50
150	0.29	0.190	0.37	0.34	0.27	0.44	0.27	0.165	0.32	0.30	0.24	0.38	0.34	0.24	0.38	0.34	0.30	0.45
185	0.23	0.190	0.32	0.29	0.27	0.39	0.22	0.160	0.27	0.25	0.23	0.34	0.29	0.23	0.34	0.29	0.29	0.41
240	0.180	0.180	0.27	0.23	0.26	0.35	0.175	0.160	0.23	0.20	0.23	0.30	0.24	0.23	0.30	0.24	0.28	0.37
300	0.145	0.180	0.24	0.190	0.26	0.32	0.140	0.155	0.21	0.165	0.22	0.28	0.20	0.22	0.28	0.20	0.28	0.34
400	0.105	0.175	0.22	0.180	0.24	0.30	0.120	0.130	0.195	0.160	0.21	0.26	0.21	0.21	0.26	0.21	0.25	0.32
500	0.086	0.170	0.21	0.165	0.23	0.29	0.105	0.145	0.180	0.145	0.20	0.25	0.190	0.20	0.25	0.190	0.24	0.30
630	0.068	0.165	0.195	0.150	0.22	0.27	0.091	0.145	0.170	0.135	0.195	0.23	0.175	0.195	0.23	0.175	0.22	0.28
800	0.053	0.160	0.185	0.145	0.21	0.25	0.082	0.140	0.160	0.125	0.180	0.22	0.170	0.180	0.22	0.170	0.195	0.26
1 000	0.042	0.155	0.180	0.140	0.19	0.24	0.079	0.135	0.155	0.125	0.165	0.21	0.165	0.165	0.21	0.165	0.170	0.24

NOTE: * Spacings larger than one cable diameter will result in larger voltage drop.

TABLE A6(4)

Multicore armoured PVC insulated cables
(COPPER CONDUCTORS)

BS 6346

CURRENT CARRYING CAPACITY (Amperes):

Ambient temperature: 30°C
Conductor operating temperature: 70°C

Conductor cross-sectional area	Reference Method C (clipped direct)		(in free air or on a perforated cable tray, etc, horizontal or vertical)	Reference Method E (in free air or on a perforated cable tray, etc, horizontal or vertical)
	1 two-core cable, single-phase, a.c. or d.c.	3		
1	2	3	4	5
mm ²	A	A	A	A
1.5	21	18	22	19
2.5	28	25	31	26
4	38	33	41	35
6	49	42	53	45
10	67	58	72	62
16	89	77	97	83
25	118	102	128	110
35	145	125	157	135
50	175	151	190	163
70	222	192	241	207
95	269	231	291	251
120	310	267	336	290
150	356	306	386	332
185	405	348	439	378
240	476	409	516	445
300	547	469	592	510
400	621	540	683	590

TABLE A6(4) (Cont.)

VOLTAGE DROP (per ampere per metre):

Conductor operating temperature: 70°C

Conductor cross-sectional area	Two-core cable d.c.	Two-core cable single phase a.c.	Three- or four-core cable three phase a.c.
1	2	3	4
mm ²	mV	mV	mV
1.5	29	29	25
2.5	18	18	15
4	11	11	9.5
6	7.3	7.3	6.4
10	4.4	4.4	3.8
16	2.8	2.8	2.4
25	1.75	1.75	1.50
35	1.25	1.25	1.10
50	0.93	0.93	0.80
70	0.63	0.63	0.55
95	0.46	0.47	0.41
120	0.38	0.38	0.35
150	0.29	0.30	0.26
185	0.23	0.25	0.21
240	0.180	0.190	0.165
300	0.145	0.155	0.135
400	0.105	0.115	0.100
	r	r	r
	x	x	x
	z	z	z
	0.170	1.75	0.145
	0.165	1.25	0.145
	0.165	0.94	0.140
	0.160	0.65	0.135
	0.155	0.50	0.130
	0.155	0.41	0.125
	0.155	0.34	0.120
	0.150	0.29	0.115
	0.145	0.21	0.110
	0.145	0.186	0.105

TABLE A6(5)

Single core XLPE insulated cables, non-armoured, with or without sheath
(COPPER CONDUCTORS)

BS 7211/BS 7889

BS 8573/BS EN 50525-3-41

Ambient temperature: 30°C
Conductor operating temperature: 90°C

CURRENT CARRYING CAPACITY (Amperes):

Conductor cross-sectional area	Reference Method A (enclosed in conduit in thermally insulating wall, etc.)		Reference Method B (enclosed in conduit on a wall or in trunking, etc.)		Reference Method C (clipped direct)		Reference Method F (in free air or on a perforated cable tray etc horizontal or vertical etc)			Reference Method G (in free air)	
	2 cables, single-phase a.c. or d.c.	3 or 4 cables, three-phase a.c.	2 cables, single-phase a.c. or d.c.	3 or 4 cables, three-phase a.c.	2 cables, single-phase a.c. or d.c. flat and touching	3 or 4 cables, three-phase a.c. flat touching or trefoil	Touching			Spaced by one diameter	
							2 cables, single-phase a.c. or d.c. flat	3 cables, three-phase a.c. flat	3 cables, three-phase a.c. trefoil	Horizontal	Vertical
1	2	3	4	5	6	7	8	9	10	11	12
mm ²	A	A	A	A	A	A	A	A	A	A	A
1	14	13	17	15	19	17.5	161	141	135	182	161
1.5	19	17	23	20	25	23	200	176	169	226	201
2.5	26	23	31	28	34	31	242	216	207	275	246
4	35	31	42	37	46	41	310	279	268	353	318
6	45	40	54	48	59	54	377	342	328	430	389
10	61	54	75	66	81	74	504	464	444	500	454
16	81	73	100	88	109	99	679	634	607	781	719
25	106	95	133	117	143	130	900	868	823	1085	1008
35	131	117	164	144	176	161	1151	1151	1088	1454	1362
50	158	141	198	175	228	209	1358	1358	1275	1775	1671
70	200	179	253	222	293	268	1719	1719	1646	2249	2104
95	241	216	306	269	355	326	2249	2249	2168	2949	2789
120	278	249	354	312	413	379	2849	2849	2768	3749	3549
150	318	285	393	342	476	436	3549	3549	3468	4649	4449
185	362	324	449	384	545	500	4249	4249	4168	5449	5249
240	424	380	528	454	644	590	5149	5149	5068	6649	6449
300	486	435	603	514	743	681	6149	6149	6068	7849	7649
400	-	-	683	584	868	793	7349	7349	7268	9449	9249
500	-	-	783	666	990	904	8449	8449	8368	10849	10649
630	-	-	900	766	1130	1033	9649	9649	9568	12449	12249
800	-	-	-	-	1288	1179	11179	11179	11100	14849	14649
1000	-	-	-	-	1443	1323	13323	13323	13244	17749	17549

TABLE A6(5) (Cont.)

VOLTAGE DROP (per ampere per metre): Conductor operating temperature: 90°C

Conductor cross-sectional area	2 cables --- single-phase a.c.										3 or 4 cables --- three-phase a.c.										
	Reference Methods A & B (enclosed in conduit or trunking)					Reference Methods C, F & G (clipped direct, on tray or in free air)					Reference Methods A & B (enclosed in conduit or trunking)					Reference Methods C, F & G (clipped direct, on tray or in free air)					
	2		3		4		5		6		7		8		9						
1	mV		mV		mV		mV		mV		mV		mV		mV						
mm ²	1.85	0.31	1.90	1.85	0.190	1.85	1.85	0.28	1.85	1.60	0.27	1.65	1.60	0.165	1.60	1.60	0.190	1.60	1.60	0.27	1.65
1	1.35	0.29	1.35	1.35	0.180	1.35	1.35	0.27	1.35	1.15	0.25	1.15	1.15	0.155	1.15	1.15	0.180	1.15	1.15	0.26	1.20
2.5	0.99	0.29	1.05	0.99	0.180	1.00	0.99	0.27	1.00	0.87	0.25	0.90	0.86	0.155	0.87	0.86	0.180	0.87	0.86	0.26	0.89
4	0.68	0.28	0.75	0.68	0.175	0.71	0.68	0.26	0.73	0.60	0.24	0.65	0.59	0.150	0.61	0.59	0.175	0.62	0.59	0.25	0.65
6	0.49	0.27	0.58	0.49	0.170	0.52	0.49	0.25	0.56	0.44	0.23	0.50	0.43	0.145	0.45	0.43	0.170	0.46	0.43	0.25	0.49
10	0.41	0.26	0.48	0.39	0.165	0.43	0.39	0.25	0.47	0.35	0.23	0.42	0.34	0.140	0.37	0.34	0.165	0.38	0.34	0.24	0.42
150	0.32	0.26	0.43	0.32	0.165	0.36	0.32	0.25	0.41	0.29	0.23	0.37	0.28	0.140	0.31	0.28	0.165	0.32	0.28	0.24	0.37
185	0.25	0.27	0.37	0.26	0.165	0.30	0.25	0.25	0.36	0.23	0.23	0.32	0.22	0.140	0.26	0.22	0.165	0.28	0.22	0.24	0.33
240	0.19	0.21	0.26	0.33	0.20	0.160	0.25	0.195	0.25	0.31	0.185	0.22	0.29	0.17	0.140	0.22	0.17	0.165	0.24	0.17	0.24
300	0.155	0.175	0.25	0.31	0.16	0.160	0.22	0.155	0.25	0.29	0.150	0.22	0.27	0.14	0.140	0.195	0.135	0.160	0.21	0.135	0.24
400	0.120	0.140	0.25	0.29	0.13	0.155	0.20	0.125	0.24	0.27	0.125	0.22	0.25	0.11	0.135	0.175	0.110	0.160	0.195	0.110	0.24
500	0.093	0.120	0.25	0.28	0.105	0.155	0.185	0.098	0.24	0.26	0.100	0.22	0.24	0.09	0.135	0.160	0.088	0.160	0.180	0.085	0.24
630	0.072	0.100	0.25	0.27	0.086	0.155	0.175	0.078	0.24	0.25	0.088	0.21	0.23	0.074	0.135	0.150	0.071	0.160	0.170	0.068	0.24
800	0.056	—	—	—	0.072	0.150	0.170	0.064	0.24	0.25	—	—	—	0.062	0.130	0.145	0.059	0.155	0.165	0.055	0.23
1000	0.045	—	—	—	0.063	0.150	0.165	0.054	0.24	0.24	—	—	—	0.055	0.130	0.140	0.050	0.155	0.165	0.047	0.23

NOTE: * Spacings larger than one cable diameter will result in a larger voltage drop.

TABLE A6(6)

Multicore XLPE insulated cables, non-armoured
(COPPER CONDUCTORS)

BS 7211
BS 7889
BS 8573

CURRENT CARRYING CAPACITY (Amperes): Ambient temperature: 30°C
Conductor operating temperature: 90°C

Conductor cross-sectional area	Reference Method A (enclosed in conduit in thermally insulating wall, etc.)		Reference Method B (enclosed in conduit on a wall or in trunking, etc.)		Reference Method C (clipped direct)		Reference Method E (in free air or on a perforated cable tray etc, horizontal or vertical)	
	2	3	4	5	6	7	8	9
1	1 two-core cable *, single-phase a.c. or d.c.	1 three-core cable or four-core cable*, three-phase a.c.	1 two-core cable *, single-phase a.c. or d.c.	1 three-core cable or four-core cable*, three-phase a.c.	1 two-core cable *, single-phase a.c. or d.c.	1 three-core cable or four-core cable*, three-phase a.c.	1 two-core cable *, single-phase a.c. or d.c.	1 three-core cable or four-core cable*, three-phase a.c.
mm ²	A	A	A	A	A	A	A	A
1	14.5	13	17	15	19	17	21	18
1.5	18.5	16.5	22	19.5	24	22	26	23
2.5	25	22	30	26	33	30	36	32
4	33	30	40	35	45	40	49	42
6	42	38	51	44	58	52	63	54
10	57	51	69	60	80	71	86	75
16	76	68	91	80	107	96	115	100
25	99	89	119	105	138	119	149	127
35	121	109	146	128	171	147	185	158
50	145	130	175	154	209	179	225	192
70	183	164	221	194	269	229	289	246
95	220	197	265	233	328	278	352	298
120	253	227	305	268	382	322	410	346
150	290	259	334	300	441	371	473	399
185	329	295	384	340	506	424	542	456
240	386	346	459	398	599	500	641	538
300	442	396	532	455	693	576	741	621
400	—	—	625	536	803	667	865	741

NOTE: *With or without protective conductor

TABLE A6(6) (Cont.)

VOLTAGE DROP (per ampere per metre):

Conductor operating temperature: 90°C

Conductor cross-sectional area	Two-core cable d.c.	Two-core cable single phase a.c.	Three-or four-core cable three phase a.c.
1	2	3	4
mm ²	mV	mV	mV
1	46	46	40
1.5	31	31	27
2.5	19	19	16
4	12	12	10
6	7.9	7.9	6.8
10	4.7	4.7	4.0
16	2.9	2.9	2.5
25	1.85	1.85	r
35	1.35	1.35	x
50	0.98	0.99	z
70	0.67	0.67	1.60
95	0.49	0.50	1.15
120	0.39	0.40	0.86
150	0.31	0.32	0.59
185	0.25	0.26	0.43
240	0.195	0.20	0.34
300	0.155	0.16	0.28
400	0.120	0.13	0.22
			0.175
			0.140
			0.115
			0.120
			1.65
			1.15
			0.87
			0.60
			0.45
			0.37
			0.30
			0.26
			0.21
			0.185
			0.165

TABLE A6(7)

Single-core armoured XLPE insulated cables
(non-magnetic armour)
(COPPER CONDUCTORS)

BS 5467
BS 6724
BS 7846

Ambient temperature: 30°C
Conductor operating temperature: 90°C

CURRENT CARRYING CAPACITY (Amperes):

Conductor cross-sectional area	Reference Method C (clipped direct)		Reference Method F (in free air or on a perforated cable tray horizontal or vertical)				Reference Method F (in free air or on a perforated cable tray horizontal or vertical)				
	Touching		Touching		Touching		Spaced by one diameter				
	2 cables, single-phase a.c. or d.c. flat	3 or 4 cables, three-phase a.c. flat	2 cables, single-phase a.c. or d.c. flat	3 cables, three-phase a.c. flat	3 cables, three-phase a.c. trefoil	2 cables, d.c.		2 cables, single-phase a.c.		3 or 4 cables, three-phase a.c.	
1	2	3	4	5	6	7	8	9	10	11	12
mm ²	A	A	A	A	A	A	A	A	A	A	A
50	237	220	253	232	222	284	270	282	266	288	266
70	303	277	322	293	285	356	349	357	337	358	331
95	367	333	389	352	346	446	426	436	412	425	393
120	425	383	449	405	402	519	497	504	477	485	449
150	488	437	516	462	463	600	575	566	539	549	510
185	557	496	587	524	529	688	660	643	614	618	574
240	656	579	689	612	625	815	782	749	714	715	666
300	755	662	792	700	720	943	906	842	805	810	755
400	853	717	899	797	815	1137	1094	929	889	848	797
500	962	791	1016	851	918	1314	1266	1032	989	923	871
630	1082	861	1146	935	1027	1528	1474	1139	1092	992	940
800	1170	904	1246	987	1119	1809	1744	1204	1155	1042	978
1000	1261	961	1345	1055	1214	2100	2026	1289	1238	1110	1041

Table A6(7) (Cont.)

VOLTAGE DROP (per ampere per metre)

Conductor operating temperature : 90°C

Con-ductor cross-sectional area	2 cables, d.c.	Reference Methods C & F (clipped direct, on tray or free air)																				
		2 cables, single-phase a.c.						3 or 4 cables, three-phase a.c.														
		touching			spaced *			trefoil and touching			flat and touching			flat and spaced *								
1	2	3	4	5	6	7	1	2	3	4	5	6	7	1	2	3	4	5	6	7		
mm ²	mV	r	x	z	r	x	z	r	x	z	r	x	z	r	x	z	r	x	z	r	x	z
50	0.98	0.99	0.21	1.00	0.98	0.29	1.00	0.86	0.18	0.87	0.84	0.25	0.88	0.84	0.25	0.88	0.84	0.33	0.90	0.84	0.33	0.90
70	0.67	0.68	0.20	0.71	0.69	0.29	0.75	0.59	0.17	0.62	0.60	0.25	0.65	0.62	0.25	0.65	0.62	0.32	0.70	0.62	0.32	0.70
95	0.49	0.51	0.195	0.55	0.53	0.28	0.60	0.44	0.17	0.47	0.46	0.24	0.52	0.49	0.24	0.52	0.49	0.31	0.58	0.49	0.31	0.58
120	0.39	0.41	0.190	0.45	0.43	0.27	0.51	0.35	0.165	0.39	0.38	0.24	0.44	0.41	0.24	0.44	0.41	0.30	0.51	0.41	0.30	0.51
150	0.31	0.33	0.185	0.38	0.36	0.27	0.45	0.29	0.160	0.33	0.31	0.23	0.39	0.34	0.23	0.39	0.34	0.29	0.45	0.34	0.29	0.45
185	0.25	0.27	0.185	0.33	0.30	0.26	0.40	0.23	0.160	0.28	0.26	0.23	0.34	0.29	0.23	0.34	0.29	0.29	0.41	0.29	0.29	0.41
240	0.195	0.21	0.180	0.28	0.24	0.26	0.35	0.180	0.155	0.24	0.21	0.22	0.30	0.24	0.22	0.30	0.24	0.28	0.37	0.24	0.28	0.37
300	0.155	0.17	0.175	0.25	0.195	0.25	0.32	0.145	0.150	0.21	0.17	0.22	0.28	0.20	0.22	0.28	0.20	0.27	0.34	0.20	0.27	0.34
400	0.115	0.145	0.170	0.22	0.180	0.24	0.30	0.125	0.150	0.195	0.16	0.21	0.27	0.20	0.21	0.27	0.20	0.27	0.33	0.20	0.27	0.33
500	0.093	0.125	0.170	0.21	0.165	0.24	0.29	0.105	0.145	0.180	0.145	0.20	0.25	0.19	0.20	0.25	0.19	0.24	0.31	0.19	0.24	0.31
630	0.073	0.105	0.165	0.195	0.150	0.23	0.27	0.092	0.145	0.170	0.135	0.195	0.24	0.175	0.195	0.24	0.175	0.23	0.29	0.175	0.23	0.29
800	0.056	0.090	0.160	0.190	0.145	0.23	0.27	0.086	0.140	0.165	0.130	0.180	0.23	0.175	0.180	0.23	0.175	0.195	0.26	0.175	0.195	0.26
1000	0.045	0.092	0.155	0.180	0.140	0.21	0.25	0.080	0.135	0.155	0.125	0.170	0.21	0.165	0.170	0.21	0.165	0.180	0.24	0.165	0.180	0.24

Note: * Spacings larger than one cable diameter will result in a larger voltage drop.

TABLE A6(8)
Multicore armoured XLPE insulated cables
(COPPER CONDUCTORS)

CURRENT CARRYING CAPACITY (Amperes):
 BS 5467
 BS 6724
 BS 7846

Ambient temperature: 30°C
 Conductor operating temperature: 90°C

Conductor cross-sectional area	Reference Method C (clipped direct)		Reference Method E (in free air or on a perforated cable tray, etc. horizontal or vertical)
	1 two-core cable, single-phase a.c. or d.c. 2	1 three or four-core cable, three-phase a.c. 3	
mm ²	A	A	A
1.5	27	23	25
2.5	36	31	33
4	49	42	44
6	62	53	56
10	85	73	78
16	110	94	99
25	146	124	131
35	180	154	162
50	219	187	197
70	279	238	251
95	338	289	304
120	392	335	353
150	451	386	406
185	515	441	463
240	607	520	546
300	698	599	628
400	787	673	728
			4
			5
			6
			7
			8
			9
			10
			11
			12
			13
			14
			15
			16
			17
			18
			19
			20
			21
			22
			23
			24
			25
			26
			27
			28
			29
			30
			31
			32
			33
			34
			35
			36
			37
			38
			39
			40
			41
			42
			43
			44
			45
			46
			47
			48
			49
			50
			51
			52
			53
			54
			55
			56
			57
			58
			59
			60
			61
			62
			63
			64
			65
			66
			67
			68
			69
			70
			71
			72
			73
			74
			75
			76
			77
			78
			79
			80
			81
			82
			83
			84
			85
			86
			87
			88
			89
			90
			91
			92
			93
			94
			95
			96
			97
			98
			99
			100

NOTE: Refer Notes 1, 2 and 3 of table A6(5).

TABLE A6(8) (Cont.)



VOLTAGE DROP (per ampere per metre):





Conductor operating temperature: 90°C

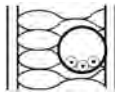
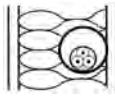
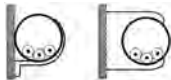
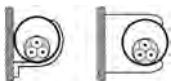
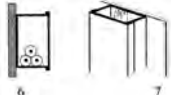
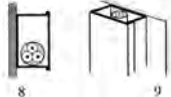
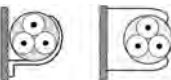

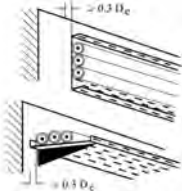
Conductor cross-sectional area	Two-core cable d.c.	Two-core cable single phase a.c.	Three-or four-core cable three phase a.c.
1	2	3	4
mm ²	mV	mV	mV
1.5	31	31	27
2.5	19	19	16
4	12	12	10
6	7.9	7.9	6.8
10	4.7	4.7	4.0
16	2.9	2.9	2.5
		r	r
25	1.85	0.160	0.140
35	1.35	0.155	0.135
50	0.98	0.155	0.135
70	0.67	0.150	0.130
95	0.49	0.150	0.130
120	0.39	0.145	0.130
150	0.31	0.145	0.125
185	0.25	0.145	0.125
240	0.195	0.140	0.125
300	0.155	0.140	0.120
400	0.120	0.140	0.120
		z	z
		1.90	1.65
		1.35	1.15
		1.00	0.87
		0.69	0.60
		0.52	0.45
		0.42	0.37
		0.35	0.30
		0.29	0.26
		0.24	0.21
		0.21	0.185
		0.13	0.115
		0.140	0.120
		0.19	0.165

Appendix 7

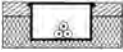
Typical Installation Method for Cables

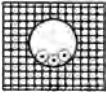
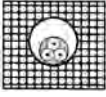
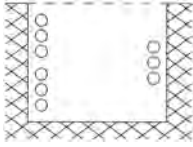
Installation Method			Reference Method to be used to determine current-carry capacity
Number	Examples	Description	
1	 Room	Non-sheathed cables in conduit in a thermally insulated wall with an inner skin having a thermal conductance of not less than 10W/m ² K (#1)	A
2	 Room	Multicore cable in conduit in a thermally insulated wall with an inner skin having a thermal conductance of not less than 10W/m ² K (#1)	A
4		Non-sheathed cables in conduit on a wooden or masonry wall or spaced less than 0.3 x conduit diameter from it (#1)	B
5		Multicore cable in conduit on a wooden or masonry wall or spaced less than 0.3 x conduit diameter from it (#1)	B
6 7		Non-sheathed cables in cable trunking on a wooden or masonry wall 6 – run horizontally (#2) 7 – run vertically (#1) (#2)	B
8 9		Multicore cable in cable trunking on a wooden or masonry wall 8 – run horizontally (#2) 9 – run vertically (#1) (#2)	B
20		Single-core or multicore cables: - fixed on (clipped direct), or spaced less than 0.3 x cable diameter from a wooden or masonry wall (#1)	C
21		Single-core or multicore cables: - fixed directly under a wooden or masonry ceiling	C (Higher than standard ambient temperature may occur with this installation method)
31		Single-core or multicore cables: - on perforated tray run horizontally or vertically (#1)(#3)	E or F

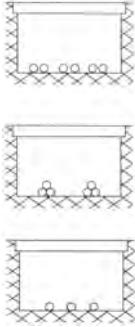
Installation Method			Reference Method to be used to determine current-carry capacity
Number	Examples	Description	
33		Single-core or multicore cables: - spaced more than 0.3 times the cable diameter from a wall	E, F or G (#4)
34		Single-core or multicore cables: - on a ladder (#1)	E or F
50		Non-sheathed cables in flush cable trunking in the floor	B
51		Multicore cable in flush cable trunking in the floor	B
59		Non-sheathed cables or single-core cables in conduit in masonry having a thermal resistivity not greater than 2K.m/W (#5)	B
60		Multicore cables in conduit in masonry having a thermal resistivity not greater than 2K.m/W (#5)	B
117		Cables supported on the wall of an open or ventilated in-floor concrete trough with spacing as follows:- - Sheathed single-core cables in free air (any supporting metalwork under the cables occupying less than 10% of plan area) - Two or three cables vertically one above the other, minimum distance between cable surfaces equal to the overall cable diameters, distance from the wall not less than 1/2 the cable diameter - Two or three cables horizontally with spacing as above	E or F







Installation Method			Reference Method to be used to determine current-carry capacity
Number	Examples	Description	
118		<p>Cables in enclosed trench 450mm wide by 300mm deep (minimum dimensions) including 100mm cover</p> <ul style="list-style-type: none"> - Two or six single-core cables with surfaces separated by a minimum of one cable diameter - One or two groups of three single-core cables in trefoil formation - One to four 2-core cables or one to three cables of 3 or 4 cores with all cables separated by a minimum of 50mm 	E or F using rating factors in Table A5(6)
119		<p>Cables enclosed in an in-floor concrete trough 450mm wide by 600mm deep (minimum dimensions) including 100mm cover.</p> <p>Six to twelve single-core cables arranged in flat groups of two or three on the vertical trench wall with cables separated by one cable diameter and a minimum of 50mm between groups.</p> <p>or</p> <p>two to four groups of three single-core cables in trefoil formation with a minimum of 50mm between trefoil formations</p> <p>or</p> <p>four to eight 2-core cables or three to six cables of 3 or 4 cores with cables separated by a minimum of 75mm</p> <p>All cables spaced at least 25mm from trench wall.</p>	E or F using rating factors in Table A5(6)



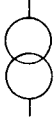



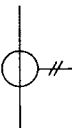



Installation Method			Reference Method to be used to determine current-carry capacity
Number	Examples	Description	
120		<p>Cables enclosed in an infloor concrete trough 600mm wide by 760mm deep (minimum dimension) including 100mm cover</p> <p>Twelve to twenty four single-core cables arranged in either flat formation of two or three cables in a group with cables separated by one cable diameter and each cable group separated by a minimum of 50mm either horizontally or vertically</p> <p>or</p> <p>single-core cable in trefoil formation with each group or trefoil formation separated by a minimum of 50mm either horizontally or vertically</p> <p>or</p> <p>eight to sixteen 2-core cables or six to twelve cables of 3 or 4 cores with cables separated by a minimum of 75mm either horizontally or vertically.</p> <p>All cables spaced at least 25mm from trench wall.</p>	E or F using rating factors in Table A5(6)







- #1 Care is needed where the cable runs vertically and ventilation is restricted. The ambient temperature at the top of the vertical section can be much higher.
- #2 Values given for Installation Method B in Appendix 6 are for a single circuit. Where there is more than one circuit in the trunking the group rating factor given in Table A5(3) is applicable, irrespective of the presence of an internal barrier or partition.
- #3 D_e = the external diameter of a multicore cable:
 - 2.2 x the cable diameter when three single-core cables are bound in trefoil, or
 - 3 x the cable diameter when three single-core cables are laid in flat formation.
- #4 The factors in Table A5(3) may also be used.
- #5 Thermal resistivity of masonry is not greater than 2K.m/W. The term masonry is taken to include brickwork, concrete, plaster and the like (excludes thermally insulating materials)





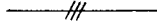
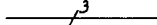
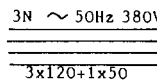

Appendix 8



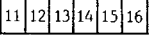

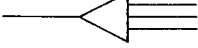
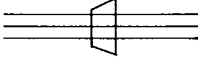





Graphical Symbols for Electrical Diagrams











No.	Symbol		Description
	Form 1	Form 2	
1.			Transformer with two windings Note - The instantaneous voltage polarities may be indicated in form 2 of the symbol. Example : - Transformer with two windings shown with instantaneous voltage polarity indicators. Instantaneous currents entering the marked ends of the windings produce aiding fluxes.
2.			
3.			Auto-transformer
4.			Current transformer











No.	Symbol	Description
5.	Form 1 	Switch (Mechanical)
6.	Form 2 	
7.		Contactor Main make contact of a contactor (contact open in the unoperated position)
8.		Contactor with automatic tripping initiated by a built-in measuring relay or release
9.		Contactor Main break contact of a contactor (contact closed in the unoperated position)
10.		Circuit breaker
11.		Disconnecter (isolator)
12.		Two-way disconnecter (isolator) with off-position in the centre
13.		Switch-disconnector (on-load isolating switch)
14.		Switch-disconnector with automatic tripping initiated by a built-in measuring relay or release
15.		Fuse, general symbol



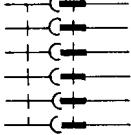
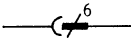





No.	Symbol	Description
16.		Fuse switch
17.		Fuse-disconnector (Fuse isolator)
18.		Fuse switch-disconnector (on-load isolating fuse switch)
19.		<p>Conductor Group of conductors Line Cable Circuit</p> <p>Notes 1. Single-line representation of conductors When a single line represents a group of conductors, their number may be indicated either by adding small strokes or one stroke and a figure</p> <p>Examples: Three conductors</p> <p>2. Additional information may be indicated as follows: Above the line: kind of current, system of distribution frequency and voltage Below the line: the number of conductors of the circuit followed by a multiplication sign and the cross-sectional area of each conductor. If different sizes of conductors are used, their particulars should be separated by a plus sign. The conductor material may be indicated by its chemical symbol</p>
20.	Form 1 	
21.	Form 2 	
22.	<p>3N ~ 50Hz 380V</p>  <p>3x120+1x50</p>	Three-phases circuit, 50Hz, 380V, three conductors of 120mm ² with neutral of 50mm ²
23.		Conductors in a cable, three conductors shown

No.	Symbol	Description
24.	•	Junction, connection point
25.	◦	Terminal
26.		Terminal strip, example shown with terminal markings
27.	Form 1 	Junction of conductors
28.	Form 2 	
29.		Cable sealing end, shown with one three-core cable
30.		Cable sealing end, shown with three one-core cables
31.		Link boxes, distribution board General symbol
32.	Form 1 	Connecting link, closed
33.	Form 2 	
34.		Connecting link, open

No.	Symbol	Description
35.		Motor starter, general symbol Note - Qualifying symbols may be shown inside the general symbol to indicate particular types of starters
36.		Starter operated in steps Note - The number of steps may be indicated
37.		Star-delta starter
38.		Auto-transformer starter
39.		Direct-on-line starter with contactor for reversing the rotation of a motor
40.		Starter-regulator with thyristors
41.		Machine, general symbol The asterisk* shall be replaced by a letter designation as follows: C Synchronous converter G Generator GS Synchronous generator M Motor MG Machine capable of use as a generator or motor MS Synchronous motor
42.		Switch, general symbol
43.		Switch with pilot light
44.		Switch, two pole

No.	Symbol	Description
45.		Pull-cord switch, single pole
46.		Two-way switch
47.		Intermediate switch
48.		Time switch
49.		Period limiting switch, single pole
50.		Dimmer
51.		Push-button
52.		Socket outlet (power), general symbol Receptacle outlet (power), general symbol
53.	<p>Form 1</p> 	Multiple socket outlet (power) The symbol is shown with three outlets.
54.	<p>Form 2</p> 	
55.		Socket outlet (power) with protective contact

No.	Symbol	Description
56.		Socket outlet (power) with shutter
57.		Socket outlet (power) with single-pole switch
58.		Socket outlet (power) with interlocked switch
59.		Socket outlet (power) with isolating transformer, for exampl: shaver outlet
60.		Multipole plug and socket, shown with six poles: multi-line representation
61.		Single-line representation
62.		Luminaire, fluorescent lamp, general symbol
63.		Example: Luminaire with three fluorescent tubes
64.		Luminaire with three fluorescent tubes, simplified representation
65.		Auxilliary apparatus for discharge lamp Note - Use only when the auxilliary apparatus is not incorporated in the luminaire
66.		Self-contained emergency luminaire
67.		Signal lamp

No.	Symbol	Description
68.		Electrical appliance: general symbol Note - If necessary use designations to specify type
69.		Fan, shown with wiring
70.		Heater Type to be specified
71.		Bell
72.		Clock
73.		Earth, general symbol Ground, general symbol
74.		Fault (indication of assumed fault location)
75.		Flashover Break-through

Appendix 9

Performance Monitoring Points System for Registered Electrical Workers / Contractors

The system, which is administered by the Director of Electrical and Mechanical Services (DEMS), serves to monitor the performance of registered electrical workers (REW) / registered electrical contractors (REC) to ensure that the electrical work undertaken by them / registered electrical worker employed by him/her is in compliance with the Electricity Ordinance (Chapter 406), in particular the Electricity (Wiring) Regulations. It provides administrative guidelines to DEMS to take appropriate action to improve the performance of REW/REC.

Further details can be found at the EMSD website:

REW:

www.emsd.gov.hk -> Protecting Public Safety -> Electricity -> Publications -> Guidance Notes / Guidelines -> Notes for Registered Electrical Workers -> PMPS for Registered Electrical Workers

REC:

www.emsd.gov.hk -> Protecting Public Safety -> Electricity -> Publications -> Guidance Notes / Guidelines -> Notes for Registered Electrical Contractors -> PMPS for Registered Electrical Contractors

Appendix 10

Degree of Protection Provided by Enclosures (IP Code)

(A) Arrangement of the IP Code

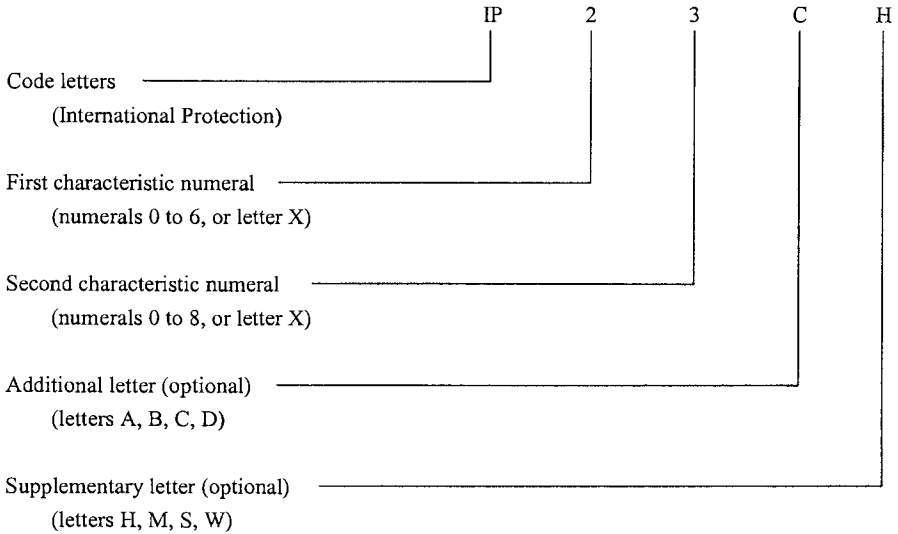

Where a characteristic numeral is not required to be specified, it shall be replaced by the letter "X" ("XX" if both numerals are omitted).

(B) Elements of the IP Code and their meanings

A brief description of the IP Code elements is given in the following chart.

Element	Numerals or letters	Meaning for the protection of equipment	Meaning for the protection of persons
Code letters	IP	-	-
First characteristic numeral	0 1 2 3 4 5 6	Against ingress of solid foreign objects (non-protected) ≥ 50 mm diameter ≥ 12.5 mm diameter ≥ 2.5 mm diameter ≥ 1.0 mm diameter dust-protected dust-tight	Against access to hazardous parts with (non-protected) back of hand finger tool wire wire wire
Second characteristic numeral	0 1 2 3 4 5 6 7 8	Against ingress of water with harmful effects (non-protected) vertically dripping dripping (15° tilted) spraying splashing jetting powerful jetting temporary immersion continuous immersion	-
Additional letter (optional)	A B C D	-	Against access to hazardous parts with: back of hand finger tool wire
Supplementary letter (optional)	H M S W	Supplementary information specific to: High voltage apparatus Motion during water test Stationary during water test Weather conditions	-

(Note: The information above is extracted from IEC 60529 ed.2.1 "Copyright©2001 IEC Geneva, Switzerland.www.iec.ch".)

Appendix 11

Forms of Internal Separations for Switchgear Assemblies

Symbols

Busbars, including distribution busbars

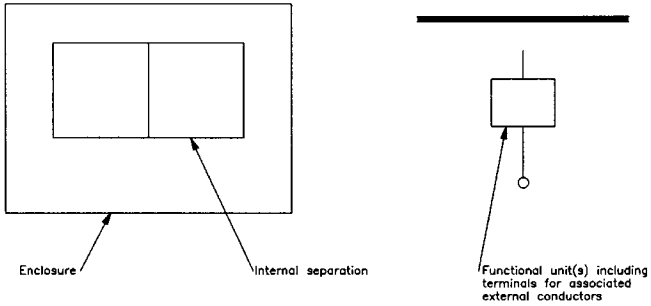
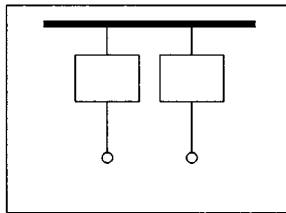

Figure A11(1) - Symbols used

Form 1

No internal separation



Form 2

Separation of busbars from the functional units

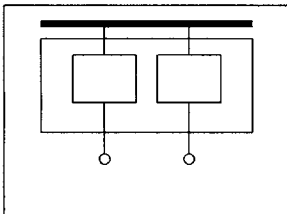

Form 2a:
Terminals not separated from busbars

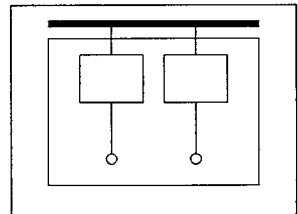

Form 2b:
Terminals separated from busbars

Figure A11(2) - Forms 1 and 2

Form 3

Separation of busbars from the functional units
+
Separation of functional units from one another
+
Separation of terminals from functional units

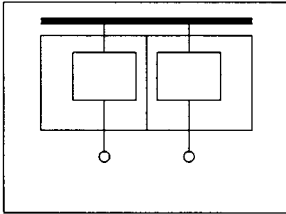

Form 3a:
Terminals not separated from busbars

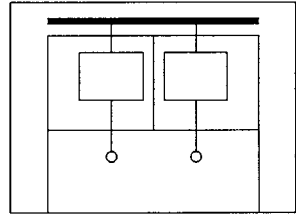

Form 3b:
Terminals separated from busbars

Form 4

Separation of busbars from the functional units
+
Separation of functional units from one another
+
Separation of terminals from functional units

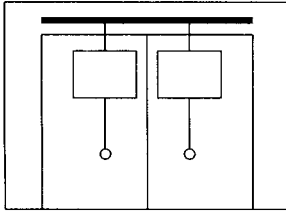

Form 4a:
Terminals in same compartment
as associated functional unit

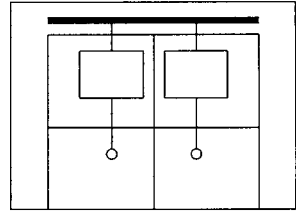

Form 4b:
Terminals separated from busbars
as associated functional unit

Figure A11(3) - Forms 3 and 4

(Note: The information above is extracted from IEC 60439-1 ed.4.1 "Copyright©2004 IEC Geneva, Switzerland.www.iec.ch".)

Appendix 12

(Reserved for Future Uses)

Appendix 13

B) Checklists

(Note: For the use of the following five checklists, please refer to Code 22)

Checklist No. 1—Items For New L.V. Installation or Items For Periodic Testing of L.V. Installations connected before 1.1.85

Installation Address: _____

Tested by/Date
(N/A if not applicable)

(a) *Switchboards, circuit breakers and main switches*

- (i) No visible damage to impair safety. _____
- (ii) Safe access provided. _____
- (iii) Every circuit breaker, main switch and fuse holder(s) provided with up-to-date, legible and durable rating labels giving their ratings. _____
- (iv) Every circuit breaker and main switch provided with a legible and durable identification label. _____
- (v) An up-to-date schematic diagram displayed to show the main distribution system. _____
- (vi) Link of adequate size installed in neutral circuit. _____
- (vii) All accessible live parts screened with insulating plate or earthed metal. _____
- (viii) The overload and fault current protection characteristics of all circuit breakers verified with secondary injection test instruments where appropriate. _____
- (ix) Lowest insulation resistance being _____ Mohms (not less than 1 Mohm) measured between phases/neutral/earth. _____
- (x) All exposed conductive parts effectively earthed with a maximum earth fault loop impedance being _____ ohms. _____

(b) *Busbar trunking system including rising mains*

- (i) No visible damage to impair safety. _____

Tested by/Date
(N/A if not applicable)

- (ii) Phase identification marked on both ends of main cable/conductor, and at terminations. _____
- (iii) All joints of metal conduit or trunking to be mechanically sound, electrically continuous and protected against corrosion. _____
- (iv) All accessible live parts screened with an insulating plate or earthed metal. _____
- (v) Lowest insulation resistance being _____ Mohms (not less than 1 Mohm) measured between phases/neutral/earth. _____
- (vi) All metal conduit or trunking effectively earthed with a maximum earth fault loop impedance being _____ ohms. _____

(c) *Meter board/box*

- (i) No visible damage to impair safety. _____
- (ii) Safe access provided. _____
- (iii) All exposed metal parts effectively earthed with a maximum earth fault loop impedance being _____ ohms. _____

(d) *Overhead lines*

- (i) No visible damage to impair safety _____
- (ii) A minimum height of _____ metres from ground (not less than 5.8 metres for lines crossing any place accessible to vehicular traffic, 5.2 metres in other places or not less than the tallest height restriction of _____ metres). _____
- (iii) Lowest insulation resistance being _____ Mohms (not less than 1 Mohm) measured between phases/neutral/earth. _____
- (iv) All metal work associated with every steel pole effectively earthed. _____

(e) *Main cables*

- (i) No visible damage to impair safety. _____
- (ii) Cables protected against mechanical damage. _____
- (iii) Correct phase identification provided at both ends of the cable. _____

Tested by/Date
(N/A if not applicable)

(iv) Lowest insulation resistance being _____ Mohms (not less than 1 Mohm) measured between cores and cores to earth.

(v) All exposed metal parts including the cable armour effectively earthed with a maximum earth fault loop impedance being _____ ohms.

(f) *Distribution board*

(i) No visible damage to impair safety.

(ii) No fuse installed in the neutral circuit.

(iii) All live parts screened with an insulating plate or earthed metal.

(iv) Phase identification provided on the distribution board.

(v) Insulation resistance of not less than 1 Mohm measured between phases/neutral/earth.

(vi) All exposed metal parts effectively earthed.

(g) *Final circuits*

(i) No visible damage to impair safety.

(ii) All non-armoured cables susceptible to damage protected with steel conduit/trunking. Bushing and rubber grommet, where necessary, provided.

(iii) Conductor sized to suit the rating of the fuse/MCB protecting the circuit.

(iv) No cable joint in final circuit.

(v) All joints of metal conduits or trunking to be mechanically sound, electrically continuous and protected against corrosion.

(vi) For temporary installation, cables lying on the ground or attached to scaffoldings secured on suitable supports.

(vii) Insulation resistance of not less than 1 Mohm measured between phases/neutral/earth.

Tested by/Date
(N/A if not applicable)

(viii) All metal conduits, trunking, switch boxes and exposed metal parts effectively earthed.

(ix) Residual current devices function properly.

(x) Earth fault loop impedance and polarities of every outlet checked.

(h) *Motors*

(i) No visible damage to impair safety.

(ii) Insulation resistance of not less than 1 Mohm measured between phases/neutral/earth.

(iii) All exposed conductive parts effectively earthed.

(i) *Earthing*

(i) No visible damage to impair safety.

(ii) All exposed conductive parts of the wiring installation connected to the earthing terminal with appropriate protective conductors.

(iii) Bonding/earthing connection to water pipe/gas pipe/duct effectively connected.

(j) *Neon signs*

(i) No visible damage to impair safety.

(ii) The fireman's switch clearly labelled.

(iii) All high voltage equipment enclosed in an earthed metal box fitted with a 'DANGER' and '危險' warning notice.

(iv) All live parts screened with an insulation plate or earthed metal.

(v) High voltage cables securely supported with glass or glazed porcelain.

(vi) Insulation resistance of the L.V. circuit being _____ Mohms (not less than 1 Mohm) between phases/neutral/earth.

(vii) All exposed metalwork permanently and effectively bonded and earthed with a maximum earth fault loop impedance of _____ ohms measured at L.V. side.

**Checklist No. 2—Additional Items For New L.V. Installation
or Items For Periodic Testing of L.V.
Installations connected on or after 1.1.85
but before 1.6.92**

Installation Address: _____

Tested by/Date
(N/A if not applicable)

(a) *Earth*

- (i) A warning notice 'SAFETY *EARTH/
ELECTRICAL CONNECTION — DO NOT
REMOVE and '安全接地終端 —— 切勿移去'
provided at all main earthing terminal
and main bonding connections. _____
- (ii) Main equipotential bonding conductors
effectively connected to main water pipes,
main gas pipes, other services pipes/ducting
and exposed metallic parts of structural
framework. _____
- (iii) Supplementary equipotential bonding
effectively provided between exposed
conductive parts and extraneous
conductive parts. _____
- (iv) Exposed conductive parts of fixed
equipment installed outside equipotential
zone effectively earthed for the required
disconnection time. _____
- (v) Exposed conductive parts of fixed
equipment installed within equipotential
zone effectively earthed for the required
disconnection time. _____
- (vi) Effectiveness of the main equipotential
bonding connection to the main earthing
terminal. _____
- (vii) Effectiveness of the main equipotential
bonding connection to the lightning
protection system. _____

*Delete whichever is inapplicable

**Checklist No. 3—Additional Items For New L.V. Installation
or Items For Periodic Testing of L.V.
Installations connected on or after 1.6.92**

Installation Address: _____

Tested by/Date
(N/A if not applicable)

(a) *Substations*

- (i) A warning notice 'DANGE—SUBSTATION, UNAUTHORISED ENTRY PROHIBITED' and '危險——電力分站 未經授權不得內進' provided at every entrance of substations in compliance with Code 17A(1). _____
- (ii) Suitable locking facilities provided for H.V. substations in compliance with Code 4F(1)(c). _____
- (iii) Suitable lighting provided in compliance with Code 4F(3)(a). _____
- (iv) Suitable ventilation provided in compliance with Code 4F(3)(a). _____
- (v) Entrance/exit free of obstruction in compliance with Code 4F(2)(c). _____

(b) *Switchrooms*

- (i) A warning notice 'DANGER—ELECTRICITY, UNAUTHORISED ENTRY PROHIBITED' and '危險——有電 未經授權不得內進' provided at every entrance of switchrooms in compliance with Code 17A(2). _____
- (ii) Suitable locking facilities provided for H.V. substations in compliance with Code 4F(1)(c). _____
- (iii) Suitable lighting provided in compliance with Code 4F(3)(a). _____
- (iv) Suitable ventilation provided in compliance with Code 4F(3)(a). _____
- (v) Entrance/exit free of obstruction in compliance with Code 4F(2)(c). _____

(c) *Switchboards, circuit breakers and main switch*

An up-to-date notice of periodic inspection and testing provided at point of supply (i.e. a switchboard, a circuit breaker or a distribution board) of the installation in compliance with Code 17D. _____

Tested by/Date
(N/A if not applicable)

(d) *Distribution boards*

- (i) A warning notice 'DANGER' and '危險' provided on the front panel of every distribution board in compliance with Code 17A(3). _____
- (ii) A notice of periodic testing provided at or near the main distribution board incorporating a residual current device in compliance with Code 17E. _____

Remarks: REC and REW are required to ensure their responsible fixed electrical installation is able to comply with the relevant requirements of this Code of Practice, rather than the items as listed in the checklists only.

Checklist No. 4—Additional Items For New L.V. Installation

Installation Address: _____

Tested by/Date
(N/A if not applicable)

(a) *Switchboards, circuit breakers and main switches*

- (i) Safe access and adequate clearance space provided in compliance with Code 4E. _____
- (ii) Number of source of supply: _____ and the rating of each of them: _____

- (iii) Maximum loading approved by the electricity supplier: _____
- (iv) Suitable interlock scheme provided to prevent parallel operation of two or more sources of supply and 4-pole incoming and interconnecting circuit breakers provided for supply to be taken from more than one source and is interconnected in compliance with Code 6B(1)(c). _____
- (v) Electrically and mechanically interlocked 4-pole changeover device(s) where standby generator set(s) is installed in compliance with Code 8A(1)(d). _____
- (vi) The breaking capacity of the main switch is _____ kA and all circuit breakers/interconnection devices are able to withstand the prospective fault current in compliance with Code 9C. _____
- (vii) Protective relays have been correctly set and overcurrent protective devices suitably set for all circuits in compliance with Code 21A(i). _____
- (viii) Protective type C.T. are used for protective relays. _____
- (ix) A means of isolation provided for every circuit in compliance with Code 8A(1)(c)(i). _____
- (x) Operation of circuit breakers and main switches checked in compliance with Code 21B(9). _____

Tested by/Date
(N/A if not applicable)

- (xi) Control, indication and alarm functions checked in compliance with Code 21B(2) (viii). _____
- (xii) No undersized conductor used between the main busbar and fuse/MCB's in compliance with Code 13A(3). _____
- (xiii) Fuses/MCB's matching the lowest rated conductor in the circuit in compliance with Code 9B. _____
- (xiv) Suitable cable terminations provided in compliance with Code 25D. _____
- (xv) Cable conductors of correct phases connected in compliance with Code 21A(b) _____
- (xvi) Single-pole devices for protection or switching connected in phase conductors only in compliance with Code 10B. _____

(b) *Busbar trunking system including rising mains*

- (i) The current rating of the rising mains is _____ amperes. _____
- (ii) The rising mains, lateral mains and meter boards positioned at places accessible from public area. _____
- (iii) Fire barriers provided where the busbar trunking system passes through floor slabs or walls designated as fire barriers in compliance with Code 14A(3). _____
- (iv) Cables passing through smoke lobby protected by enclosures of adequate fire rating. _____
- (v) Non-sheathed cables protected by conduit, trunking or ducting in compliance with Code 15. _____
- (vi) Busbar trunking systems, cables and ductings adequately supported in compliance with Code 14A(2). _____
- (vii) Armoured cables properly terminated to metal casing or trunking by proper cable glands in compliance with Code 25D(7). _____

Tested by/Date
(N/A if not applicable)

(viii) Suitable cable lugs used for terminating cables in compliance with Code 4, Code 13C and Code 25D.

(ix) Precaution against corrosion taking on aluminium conductor joined to copper conductor in compliance with Code 25D(7)(d)(ii).

(x) Cutout fuses for tapping off supply fitted with insulated carriers in compliance with Code 26B(6)(e).

(c) *Overhead lines*

(i) A steel carrier wire provided between poles to prevent strain on conductors in compliance with Code 16A and 16H.

(ii) Substantial steel poles used to suspend cables crossing vehicular passes in compliance with Code 26K(3)(b)(ii).

(iii) Overhead cables supported on suitable insulators in compliance with Code 16B.

(iv) Suitable stay wires installed on the terminal poles and on each pole at which the line changes its direction in compliance with Code 16G(1).

(v) Minimum clearance of overhead lines to ground, roads and obstacles maintained in compliance with Code 16E(2)(a), (b) and (c).

(d) *Main cables*

(i) The cross-sectional area of each core of the main supply cable is _____ mm². Number of cables in parallel, if connected is _____.

(ii) Armoured cables properly terminated to metal casing or trunking by proper cable glands in compliance with Code 25D(7).

(iii) Cables passing through smoke lobby protected by enclosures of adequate fire rating.

(iv) Non-sheathed cables protected by conduit, trunking or ducting in compliance with Code 15.

Tested by/Date
(N/A if not applicable)

- (v) Cables and ductings adequately supported in compliance with Code 14A(2). _____
- (vi) Cables at distribution board or busbar terminated with cable lugs in compliance with Code 4, Code13C and Code 25D. _____
- (vii) Main cables connected up with correct polarity. _____

(e) *Distribution board*

- (i) Safe access and adequate clearance space provided in compliance with Code 4E. _____
- (ii) Distribution boards securely mounted on suitable supports in compliance with Code 14A(2). _____
- (iii) A suitable switch provided to control each distribution board in compliance with Code 8A(1)(a). _____
- (iv) Phase barriers for 3-phase distribution board provided in compliance with Code 21A(g). _____
- (v) The breaking capacity of MCB is _____ kA to Code 9. _____
- (vi) Suitable tools for withdrawal of fuses at a fuse board provided, where necessary in compliance with Code 9E(d) _____
- (vii) Circuits connected to MCB or fuse in accordance with the schematic diagram in compliance with Code 6A(b). _____

(f) *Final circuits*

- (i) All fuses and single pole switches connected to the phase conductors only with correct polarity. _____
- (ii) Wiring for emergency lightings and fire services installation segregated from other wirings in compliance with Code 5B(1)(b). _____
- (iii) Low voltage circuits segregated from extra low voltage circuits in compliance with Code 5B(1)(a). _____

Tested by/Date
(N/A if not applicable)

- (iv) Cables of all phases and neutral of the circuit bunched and contained in the same conduit in compliance with Code 25A(1)(f). _____
- (v) Exposed insulated non-sheathed cables protected in compliance with Code 15. _____
- (vi) Wiring inside false ceiling protected by conduit/trunking or metallic sheath in compliance with Code 25C(1)(f). _____
- (vii) Socket outlets installed below 1.5 m from floor being shuttered type complying to the prescribed requirements. _____
- (viii) No socket outlet installed close to water tap, gas tap or cooker so as to avoid danger in compliance with Code 25E(d). _____
- (ix) Floor socket outlets protected with suitable cover in compliance with Code 25E(b). _____
- (x) No 2-pin sockets installed. All socket outlets connected with protective conductors and live conductors terminated at correct terminals. _____
- (xi) Radial final circuits using 5A/15A socket outlets in compliance with Code 6D. _____
- (xii) Final circuits using 13A socket outlets in compliance with Code 6E. _____
- (xiii) Final circuits using industrial socket outlets in compliance with Code 6F or 6G or 6H. _____
- (xiv) Circuit protective conductor is formed by the enclosure and a separate protective conductor between the earthing terminal of socket outlet and its associated metal box provided in compliance with Code 11D(3). _____
- (xv) Circuit protective conductor is not formed by the enclosure and a separate protective conductor to the earthing terminal of socket outlet provided in compliance with Code 11D(3). _____
- (xvi) Residual current device of 30 mA rated residual operating current provided for all socket outlets in compliance with Code 11B(b)(i). _____

Tested by/Date
(N/A if not applicable)

- (xvii) Means of isolation provided for every fixed appliance in compliance with Code 8A(1)(c). _____
- (xviii) All chokes, starters and capacitors of discharge lamps enclosed in earthed metal box(es) and suitably ventilated in compliance with Code 26H(4)(c). _____
- (xix) Phase conductors connected to the centre contact of the Edison-type screw lamp holders in compliance with Code 21B(6)(ii). _____
- (xx) No switches other than a switch fed from a safety source or operated by an insulation cord or rod or a push-button type of switch having an insulated button of a large surface area provided in bathrooms in compliance with Code 26A(3)(d). _____
- (xxi) Shaver supply unit complying with BSEN 61558-2-5 or equivalent in compliance with Code 26A(3)(e). _____
- (xxii) Socket outlet in bathroom installed beyond Zone 2 (i.e. 0.6m away from shower basin or bathtub) protected by an RCD with a residual operating current not exceeding 30mA or protected by an isolating transformer to BSEN 61558 in compliance with Code 26A(3)(j). _____
- (xxiii) No fixed luminaire nor fixed heater having unguarded heating elements installed within reach of a person using the bath or shower in compliance with Code 26A(3)(h). _____
- (xxiv) All circuits supplying electrical equipment with exposed conductive parts within 2.25m height above finished floor level in bathroom protected by RCD having a rated residual operating current not exceeding 30mA in compliance with Code 26A(3)(a). _____
- (xxv) Appliances exposed to weather being splashproof type in compliance with Code 15A. _____
- (xxvi) Luminaires, switches, sockets and plugs, cable couplers installed outdoor, being splashproof type in compliance with Code 15A. _____

Tested by/Date
(N/A if not applicable)

(xxvii) General/site lighting readily accessible to the public supplied from a safety source in compliance with Code 26K(3).

(xxviii) General/site lighting not readily accessible to the public and not supplied from a safety source, protected by RCD having a rated residual operating current not exceeding 30 mA.

(g) *Motors*

(i) A local switch provided to control every motor in compliance with Code 8A(4)(a).

(ii) Means provided to prevent unexpected restarting of motors where such restarting might cause danger in compliance with Code 8A(4)(c).

(iii) Flexible conduits terminated with suitable brass bushes in compliance with Code 25A(2)(b)(i).

(iv) Separate supply to motor heaters having its terminals screened, with warning notice provided.

(h) *Earthing*

(i) Rod electrode(s) having a minimum diameter 12.5 mm copper or 16 mm galvanised or stainless steel used in compliance with Code 12C(2)(a) and (b).

(ii) Copper tape electrode having a cross-section of not less than 25 mm × 3 mm in compliance with Code 12C(3)(a).

(iii) Copper plate electrode not less than 3 mm in thickness and having a maximum dimension of 1 200 mm × 1 200 mm in compliance with Code 12C(4).

(iv) No gas/water pipe used as earth electrodes in compliance with Code 12C(1)(b).

(v) A test link provided at the main earthing terminal.

(vi) Minimum size of protective conductor used in compliance with Table 11(1).

Tested by/Date
(N/A if not applicable)

- (vii) Protective conductor up to and including 6 mm² with green and yellow insulation sheath used throughout its length. _____
- (viii) Bonding conductors of _____ mm² (not less than 150 mm² copper equivalent) used for connection to the earthing terminal of the electricity supplier's transformer(s) in compliance with Code 11G(b). _____
- (ix) Bonding conductors of _____ mm² (not less than 150 mm² copper equivalent) used for connection to the exposed conductive parts of the electricity supplier's underground cable(s) in compliance with Code 11G(b). _____
- (x) Copper links provided at joints of metallic trunking which forms part of a protective conductor in compliance with Code 14A. _____
- (xi) Separate protective conductors provided for all flexible conduits in compliance with Code 11D(3)(b). _____

(i) *Lightning Protection*

- (i) Air termination network/down conductor/earth termination network having good continuity in compliance with relevant standard listed under Code 26I. _____
- (ii) Joints and connections are mechanically and electrically sound in compliance with relevant standard listed under Code 26I. _____
- (iii) Connection link to the main earthing terminal provided in compliance with relevant standard listed under Code 26I. _____
- (iv) Test joint provided in compliance with relevant standard listed under Code 26I. _____
- (v) Rod electrode(s) having a minimum diameter 12.5 mm copper or 16 mm galvanised or stainless steel used in compliance with Code 12C(2)(a) and (b). _____
- (vi) Copper tape electrode having a cross-section of not less than 25 mm × 3 mm in compliance with Code 12C(3)(a). _____

Tested by/Date
(N/A if not applicable)

(vii) Copper plate electrode not less than 3 mm in thickness and having a maximum dimension of 1 200 mm × 1 200 mm in compliance with Code 12C(4).

(viii) No gas/water pipe used as earth electrodes in compliance with Code 12C(1)(b)

(ix) Measured earth termination network resistance to earth not more than 10 Ohm when the connection to main earthing terminal disconnected in compliance with relevant standard listed under Code 26I.

(x) No evidence of corrosion likely to lead deterioration of the lightning protection system.

(j) *High voltage discharge lighting (Neon signs)*

(i) _____ampere control switch fitted with a removable handle or locking facilities in compliance with Code 26H(2)(b).

(ii) Fireman's switch provided with the 'OFF' position at the top in compliance with Code 8B(4)(g)(ii).

(iii) High voltage cables exceeding 1 metre in length for connection between lamps and transformers, being metal sheathed or armoured.

(iv) Bare or lightly insulated conductors for high voltage connection protected with glass tubing.

(k) *Warning notices and labels*

(i) Warning notices for substations and switchrooms provided in compliance with Code 17.

(ii) Warning notices for earthing and main bonding connections provided in compliance with Code 17.

(iii) All switchgears, distribution boards and electrical equipment properly labelled in compliance with Code 4D(1).

Tested by/Date
(N/A if not applicable)

(I) *Installation having both new and old cable colours*

- (i) Warning notice provided in compliance with Code 17 and Appendix 18 _____
- (ii) Proper labels provided near the cable termination interface to identify new colour cables / conductors for 1-phase circuits in compliance with Appendix 18 _____
- (iii) Proper labels provided near the cable termination interface to identify both the new and old colour cables / conductors for 3-phase circuits in compliance with Appendix 18 _____
- (iv) Conductors are properly identified in compliance with Code 13D(2). _____

Remarks: REC and REW are required to ensure their responsible fixed electrical installation is able to comply with the relevant requirements of this Code of Practice, rather than the items as listed in the checklists only.

Checklist No. 5—Items for H.V. Installation

(Note: For L.V. Installation/Equipment, please refer to other checklists in this appendix)

Installation Address: _____

Tested by/Date
(N/A if not applicable)

- (a) *Switchboard, circuit breakers*
 - (i) No visible damage to impair safety in compliance with Code 21A. _____
 - (ii) Safe access and adequate clearance space provided in compliance with Code 4E. _____
 - (iii) Work done properly recorded in log book in compliance with Code 4H(2)(d). _____
 - (iv) Every circuit breaker provided with a legible and durable identification label in compliance with Code 4D(1). _____
 - (v) An up-to-date schematic diagram displayed in compliance with Code 6A(b). _____
 - (vi) All accessible live parts screened with insulating plate or earthed metal in compliance with Code 4C(2)(b) _____
 - (vii) All exposed conductive parts effectively earthed in compliance with Code 11D. _____
 - (viii) Earthing system effectively connected in compliance with Code 12. _____
 - (ix) Warning notice displayed at main bonding connections in compliance with Code 17B. _____
 - (x) All protective devices are functioned properly and correctly set in compliance with Code 21B(9). _____
 - (xi) Padlock facilities for shutters provided in compliance with Code 21C(c). _____
 - (xii) Maintenance test carried out according to relevant recognised standards and manufacturers' recommendation, where appropriate, with test reports. (insulation resistance test, pressure test, ductor test, oil

Tested by/Date
(N/A if not applicable)

dielectric strength test etc.) in compliance with Code 21D(2).

(b) *Main Cables*

(i) No visible damage to impair safety in compliance with Code 21A.

(ii) Cables protected against mechanical damage and suitably supported in compliance with Code 25C.

(iii) All exposed metal parts including the armour effectively earthed in compliance with Code 11D.

(iv) Maintenance test carried out according to relevant recognised standards and manufacturers' recommendation, where appropriate, with test reports. (insulation resistance test, pressure test etc.) in compliance with Code 21D(2).

(c) *Transformers/Motors*

(i) No visible damage to impair safety in compliance with Code 21A.

(ii) All accessible live parts screened with insulating plate or earthed metal in compliance with Code 4C(2)(b)

(iii) Proper ventilation provided to avoid excessive temperature rise in compliance with Code 4F(3).

(iv) Maintenance test carried out according to relevant recognised standards and manufacturers' recommendation, where appropriate, with test reports. (insulation resistance test, pressure test, oil dielectric strength test etc.) in compliance with Code 21D(2).

Tested by/Date
(N/A if not applicable)

(d) *Earth*

(i) A warning notice 'SAFETY EARTH CONNECTION—DO NOT REMOVE' and '安全接地終端——切勿移去' provided at all main earthing terminal and main bonding connections in compliance with Code 17B.

(ii) Earthing conductors of adequate size.

(e) *D.C. Battery System*

(i) Condition of battery system.

(ii) Voltage of each battery cell measured.

(f) *Operation and Testing tools and equipment*

(i) Proper operation tools and equipment provided for switching and isolation use.

(ii) Suitable self-test high voltage tester provided for verifying equipment dead.

Remarks: REC and REW are required to ensure their responsible fixed electrical installation is able to comply with the relevant requirements of this Code of Practice, rather than the items as listed in the checklists only.

Appendix 14

References

References may be made to the following publications for better applying and understanding of the requirements of the CoP.

IEC 60079	Electrical apparatus for explosive gas atmospheres
IEC 60085	Electrical insulation - Thermal classification
IEC 60127	Miniature fuses
IEC 60189	Low-frequency cables and wires with PVC insulation and PVC sheath
IEC 60227	Polyvinyl chloride insulated cables of rated voltages up to and including 450/750 V
IEC 60228	Conductors for insulated cables
IEC 60238	Edison screw lampholders
IEC 60245	Rubber insulated cables of rated voltages up to and including 450/750 V
IEC 60269	Low-voltage fuse
IEC 60309	Plugs, socket-outlets and couplers for industrial purposes
IEC 60364	Low-voltage electrical installations / Electrical installations of buildings
IEC 60423	Conduit systems for cable management - Outside diameters of conduits for electrical installations and threads for conduits and fittings
IEC 60529	Degree of protection provided by enclosures (IP Code)
IEC 60617	Graphical symbols for diagrams
IEC 60669	Switches for household and similar fixed electrical installations
IEC 60702	Mineral insulated cables and their terminations with a rated voltage not exceeding 750 V
IEC 60755	General requirements for residual current operated protective devices
IEC 60800	Heating cables with a rated voltage of 300/500 V for comfort heating and prevention of ice formation

IEC 60898	Electrical accessories - Circuit-breakers for overcurrent protection for household and similar installations
IEC 60947	Low-voltage switchgear and controlgear
IEC 60950	Information technology equipment - Safety
IEC 61008	Residual current operated circuit-breakers without integral overcurrent protection for household and similar uses (RCCBs)
IEC 61009	Residual current operated circuit-breakers with integral overcurrent protection for household and similar uses (RCBOs)
IEC 61084	Cable trunking and ducting systems for electrical installations
IEC 61140	Protection against electric shock - Common aspects for installation and equipment
IEC 61386	Conduit systems for cable management
IEC 61439	Low-voltage switchgear and controlgear assemblies
IEC 61643	Low-voltage surge protective devices
IEC 62305	Protection against lightning
IEEE 519	IEEE recommended practices and requirements for harmonic control in electrical power systems
BS EN 50085	Cable trunking systems and cable ducting systems for electrical installations
BS EN 50174	Information technology - Cabling installation
BS EN 50310	Application of equipotential bonding and earthing in buildings with information technology equipment
BS EN 50525-1	Electric Cables. Low Voltage energy cables of rated voltages up to and including 450/750V. General requirements.
BS EN 50525-2-11	Electric Cables. Low Voltage energy cables of rated voltages up to and including 450/750V. Cables for general applications. Flexible cables with thermoplastic PVC insulation.
BS EN 50525-2-12	Electric Cables. Low Voltage energy cables of rated voltages up to and including 450/750V. Cables for general applications. Cables with thermoplastic PVC insulation for extensible leads.

BS EN 50525-2-21	Electric Cables. Low Voltage energy cables of rated voltages up to and including 450/750V. Cables for general applications. Flexible cables with crosslinked elastomeric insulation
BS EN 50525-2-31	Electric cables. Low voltage energy cables of rated voltages up to and including 450/750V. Cables for general applications. Single core non-sheathed cables with thermoplastic PVC insulation
BS EN 50525-2-41	Electric Cables. Low Voltage energy cables of rated voltages up to and including 450/750V. Cables for general applications. Single core cables with crosslinked silicone rubber insulation.
BS EN 50525-2-42	Electric Cables. Low Voltage energy cables of rated voltages up to and including 450/750V. Cables for general applications. Single core non-sheathed cables with crosslinked EVA insulation.
BS EN 50525-2-51	Electric Cables. Low Voltage energy cables of rated voltages up to and including 450/750V. Cables for general applications. Oil resistant control cables with thermoplastic PVC insulation.
BS EN 50525-2-71	Electric Cables. Low Voltage energy cables of rated voltages up to and including 450/750V. Cables for general applications. Flat tinsel cables (cords) with thermoplastic PVC insulation
BS EN 50525-2-83	Electric Cables. Low Voltage energy cables of rated voltages up to and including 450/750V. Cables for general applications. Multicore cables with crosslinked silicone rubber insulation.
BS EN 50525-3-21	Electric Cables. Low Voltage energy cables of rated voltages up to and including 450/750V. Cables for general applications. Cables with special fire performance. Flexible cables with halogen-free crosslinked insulation, and low emission of smoke.
BS EN 50525-3-41	Electric cables. Low voltage energy cables of rated voltages up to and including 450/750 V. Cables with special fire performance. Single core non-sheathed cables with halogen-free crosslinked insulation, and low emission of smoke
BS EN 60069	Switches for household and similar and similar fixed-electrical installations.

BS EN 60332-1-2	Tests on electric and optical fibre cables under fire conditions - Test for vertical flame propagation for a single insulated wire or cable - Procedure for 1 kW pre-mixed flame
BS EN 60332-3	Tests on electric and optical fibre cables under fire conditions - Test for vertical flame spread of vertically mounted bunched wires or cables - Apparatus
BS EN 60335	Household and similar electrical appliances - Safety
BS EN 60335-2-96	Household and similar electrical appliances. Safety. Particular requirements for flexible sheet heating elements for room heating
BS EN 60423	Conduit systems for cable management - Outside diameters of conduits for electrical installations and threads for conduits and fittings
BS EN 60439	Low-voltage switchgear and controlgear assemblies
BS EN 60598	Luminaires
BS EN 60669	Switches for household and similar fixed electrical installations
BS EN 60947-1	Low - voltage switchgear and controlgear - General rules
BS EN 60947-2	Low-voltage switchgear and controlgear - Circuit-breakers
BS EN 60947-3	Low-voltage switchgear and controlgear - Switches, disconnectors, switch-disconnectors and fuse-combination units
BS EN 60947-4	Low-voltage switchgear and controlgear - Contactors and motor-starters - Electromechanical contactors and motor-starters
BS EN 61008	Residual current operated circuit-breakers without integral overcurrent protection for household and similar uses (RCCBs)
BS EN 61009	Residual current operated circuit-breakers with integral overcurrent protection for household and similar uses (RCBO's)
BS EN 61034-2	Measurement of smoke density of cables burning under defined conditions - Test procedure and requirements
BS EN 61386	Conduit systems for cable management
BS EN 61534	Powertrack systems

BS EN 61558	Safety of power transformers, power supplies, reactors and similar products
BS EN 61558-2-5	Safety of power transformers, power supply units and similar - Particular requirements for shaver transformers and shaver supply units
BS EN 62305	Protection against lightning
BS EN 62395-1	Electrical resistance trace heating systems for industrial and commercial applications. General and testing requirements
BS 31	Specification - Steel conduit and fittings for electrical wiring
BS 88 - 2	Low-voltage fuses. Supplementary requirements for fuses for use by authorized persons (fuses mainly for industrial application). Examples of standardized systems of fuses A to K
BS 88 - 3	Low-voltage fuses. Supplementary requirements for fuses for use by unskilled persons (fuses mainly for household or similar applications). Examples of standardized systems of fuses A to F
BS 476 Part 20	Fire tests on building materials and structures. Method for determination of the fire resistance of elements of construction (general principles)
BS 546	Specification-Two-pole and earthing-pin plugs, socket-outlets and socket-outlet adaptors
BS 1363	13 A plugs, socket-outlets, adaptors and connection units
BS 2782 Part 1	Methods of testing plastics-Thermal properties
BS 3036	Specification - Semi-enclosed electric fuses (ratings up to 100 amperes and 240 volts to earth)
BS 4444	Guide to electrical earth monitoring and protective conductor proving
BS 4607	Non-metallic conduits and fittings for electrical installations
BS 4662	Boxes for flush mounting of electrical accessories. Requirements and test methods and dimensions
BS 4678	Cable trunking
BS 5266	Emergency lighting

BS 5467	Electric cables. Thermosetting insulated, armoured cables for voltages of 600/1000 V and 1900/3300 V
BS 5839	Fire detection and fire alarm systems for buildings
BS 6004	Electric cables. PVC insulated, non-armoured cables for voltages up to and including 450/750 V, for electric power, lighting and internal wiring.
BS 6231	Electric cables. Single core PVC insulated flexible cables of rated voltage 600/1000 V for switchgear and controlgear wiring
BS 6387	Specification for performance requirements for cables required to maintain circuit integrity under fire conditions
BS 6701	Telecommunications equipment and telecommunications cabling. Specification for installation, operation and maintenance
BS 6724	Electric cables. Thermosetting insulated, armoured cables for voltages of 600/1000 V and 1900/3300 V, having low emission of smoke and corrosive gases when affected by fire
BS 7211	Electric cables. Thermosetting insulated, non-armoured cables for voltages up to and including 450/750 V, for electric power, lighting and internal wiring, and having low emission of smoke and corrosive gases when affected by fire
BS 7629	Specification for 300/500 V fire resistant electric cables having low emission of smoke and corrosive gases when affected by fire
BS 7671	Requirements for electrical installations. IEE Wiring Regulations. Seventeenth Edition
BS 7846	Electric cables. Thermosetting insulated, armoured, fire-resistant cables of rated voltage 600/1000 V, having low emission of smoke and corrosive gases when affected by fire. Specification
BS 7919	Electric cables. Flexible cables rated up to 450/750V, for use with appliances and equipment intended for industrial and similar environments
BS 8436	Electric cables. Specification for 300/500 V screened electric cables having low emission of smoke and corrosive gases when affected by fire, for use in walls, partitions and building voids. Multicore cables

BS 8573	Electric cables. Thermosetting insulated, non-armoured cables with a voltage of 600/1 000V, for fixed installations, having low emissions of smoke and corrosive gases when affected by fire
AS/NZS 1768	Lightning protection
NFPA 780	Standard for the installation of lightning protection systems

References may be made to the following publications for the common personal protective equipment and tools used for electrical work.

BS EN 60900	Live working - Hand tools for use up to 1000 V a.c. and 1500 V d.c.
BS EN 60903	Live working - Gloves of insulating material
BS EN ISO 20345	Personal protective equipment - Safety footwear
BS IEC 61111	Matting of insulating material for electrical purposes
BS IEC 61112	Blankets of insulating material for electrical purposes
ASTM F1506	Standard performance specification for flame resistant textile materials for wearing apparel for use by electrical workers exposed to momentary electric arc and related thermal hazards

Appendix 15

Safety for Live Work

(A) Conditions and Safety Precautions for Live Work

1. Live work should not be performed unless:
 - (i) it is necessary in the interests of safety, whether or not electrical safety, for the work to be performed while the electrical equipment is energised (e.g. work on hospital equipment); or
 - (ii) a supply of electricity is essential for the proper performance of the electrical measurement (e.g. testing and fault finding); or
 - (iii) there is no reasonable alternative to perform the electrical work by live work (e.g. widespread outages of a building would occur if live work is not allowed); or
 - (iv) it is justified and approved by the registered electrical worker, registered electrical contractor and owner of the installation (e.g. serious public inconvenience would arise from isolating the circuits).

2. Where live work is unavoidable, adequate precautions should be taken to avoid danger for work involving the handling of energised parts or working within touchable distance, direct or indirect, of energised parts at low voltage. The following precautions are to be taken:
 - (i) work on energised low voltage electrical equipment should be done only by registered electrical workers who are by virtue of knowledge and training competent to be allowed to carry out live work;
 - (ii) electrical safety assessment should be carried out by responsible assessor on the performance of the live work (sample provided);
 - (iii) personal protective equipment (including insulating gloves, safety shoes and insulating mat) and testing equipment appropriate to the performance of the live work should be properly used by the person performing the electrical work;
 - (iv) screen or other means to avoid danger from inadvertent contact with energised conductors should be provided;
 - (v) fixing of warning notices for repair, barriers and screens;
 - (vi) the duration and the extent of the live work should be minimized as far as practicable; and
 - (vii) the isolation point of the electricity supply for the subject electrical equipment has been clearly identified.

Appendix 15B (Sample)

Electrical Safety Assessment Form (電力安全評估表格)

Form No. (表格編號) :

Date (日期) : Time (時間) : Location (地點) :

Details of work to be done (要進行的工程詳情) :

由負責評估者評估

Assessed by (姓名)
Responsible Assessor (Name)

(簽署)
(Signed)

由負責工作人士接收

Received by (姓名)
Person in-charge (Name)

(簽署)
(Signed)

**在帶電工作時，如上游開關裝置已停用但中性導體沒有隔離時，請只需填寫“甲部”。如上游開關裝置沒有停用時，請只需填寫“乙部”。
Please complete Part A only when carrying out LIVE work with switching device at upstream “OFF” but neutral conductor not isolated. Complete Part B only when carrying out LIVE work with switching device at upstream “ON”**

甲部 Part A

帶電工作時上游開關器件狀況

(Condition of Switching Device at Upstream under LIVE WORK)

- 三極及中性線連桿空氣斷路器停用中 TPN ACB “OFF” 三極及中性線連桿模製外殼斷路器停用中 TPNMCCB “OFF”
 - 三極及中性線連桿熔斷器開關擊停用中 TPN Fused-Switch “OFF” 單極微型斷路器停用中 Single -pole MCB “OFF”
 - 單極開關擊停用中 Single-Pole Switch “OFF” 其他 (請註明)
- Others (Please specify)

請在適當方格加上剔號

Please tick in the appropriate boxes

注意：

- 小心中性導體有電
- 請確認電力器具已放電
- 請確認相性導體已截斷電源
- 請使用適當的個人保護設備

BEWARE OF ELECTRICITY AT NEUTRAL CONDUCTORS

- ENSURE ELECTRICAL EQUIPMENT HAS BEEN DISCHARGED
- ENSURE PHASE CONDUCTORS HAVE BEEN MADE DEAD
- PLEASE USE APPROPRIATE PERSONAL PROTECTIVE EQUIPMENT (PPE)

乙部 Part B

帶電工作時上游開關器件狀況

(Condition of Switching Device at Upstream under LIVE WORK)

- 請在適當方格加上剔號
- Please tick in the appropriate boxes
- 四極空氣斷路器供電中 4P ACB "ON" 四極模對外殼斷路器供電中 4P MCCB "ON"
- 三極及中性線連桿模對外殼斷路器供電中 TPNACB "ON" 三極及中性線連桿空氣斷路器供電中 TPN ACB "ON"
- 雙極開關型供電中 Double-pole Switch "ON" 雙極微型斷路器供電中 Double-pole MCB "ON"
- 單極開關型供電中 Single-pole Switch "ON" 單極微型斷路器供電中 Single-pole MCB "ON"
- 其他 (請註明)
- Others (Please specify)

在帶電工作時，沒有將上游開關器件停用的原因 (見附錄 15)

- Reasons for keeping switching device at upstream "ON" when carrying out LIVE work (see Appendix 15)
- 從安全的角度 (不論是否從電力安全的角度) 來看，有需要帶電進行工作 (例如醫院設備進行電力工作)
- It is necessary in the interests of safety, whether or not electrical safety, for the work to be performed while the electrical equipment is energized (e.g. work on hospital equipment)
- 有必要提供電力，以便適當地進行電力量度 (例如進行測試及故障探測)
- A supply of electricity is essential for the proper performance of the electrical measurement (e.g. testing and fault finding)
- 除了在器具帶電的情況下進行電力工作外，沒有其他切實可行的選擇 (例如不獲准進行帶電工作，樓宇會出現廣泛停電)
- There is no reasonable alternative to perform the electrical work by live work (e.g. widespread outages of a building would occur if live work is not allowed)
- 註冊電業工程人員、註冊電業承辦商及電力裝置擁有人均認為進行這類工作理由充份 (例如隔離電路會為公眾帶來嚴重不便)，並批准進行這類工作
- It is justified and approved by the registered electrical worker, registered electrical contractor and owner of the installation (e.g. serious public inconvenience would arise from isolating the circuits)

評估結果	受影響人士及環境	建議控制措施	備註
<input type="checkbox"/> 觸電 Electric Shock	<input type="checkbox"/> 協助帶電工作的人士 Persons assisting for LIVE WORK	<input type="checkbox"/> 使用適當的帶電作業手持工具 (見附錄 14) The use of appropriate hand tools for live working (see Appendix 14)	
<input type="checkbox"/> 爆炸 Explosion	<input type="checkbox"/> 其他不涉及帶電工作的工人 (例如：建築工人、水喉匠、等等) Other workers not involving in the LIVE WORK (e.g. builders, plumbers, etc.)	<input type="checkbox"/> 使用適當的帶電作業用絕緣材料手套 (見附錄 14) The use of appropriate gloves for live working (see Appendix 14)	
<input type="checkbox"/> 其他 (請註明) Others (Please specify)	<input type="checkbox"/> 附近的住戶/租戶 Tenants in the vicinity <input type="checkbox"/> 附近的公眾 Public in the vicinity	<input type="checkbox"/> 使用適當的安全鞋靴 (見附錄 14) The use of appropriate safety footwear (see Appendix 14) <input type="checkbox"/> 使用適當的電工用絕緣材料膠 (見附錄 14) The use of appropriate matting for electrical purpose (see Appendix 14)	
<input type="checkbox"/> <input type="checkbox"/> <input type="checkbox"/>	<input type="checkbox"/> 其他 (請註明) Others (Please specify)	<input type="checkbox"/> 使用適當的電工用絕緣材料毯 (見附錄 14) The use of appropriate blankets for electrical purpose (see Appendix 14)	
<input type="checkbox"/> <input type="checkbox"/> <input type="checkbox"/>	<input type="checkbox"/> <input type="checkbox"/> <input type="checkbox"/>	<input type="checkbox"/> 使用屏障或其他設備，以防止無意觸及帶電部分 The use of screen or other means to avoid inadvertent contact with live parts	
<input type="checkbox"/> <input type="checkbox"/> <input type="checkbox"/>	<input type="checkbox"/> <input type="checkbox"/> <input type="checkbox"/>	<input type="checkbox"/> 不應將工具放在電氣設施之內或頂部上 facilities No equipment should be placed inside or at top of electric facilities	
<input type="checkbox"/> <input type="checkbox"/> <input type="checkbox"/>	<input type="checkbox"/> 其他 (請註明) Others (Please specify)	<input type="checkbox"/> <input type="checkbox"/> <input type="checkbox"/>	

工作許可證 PERMIT-TO-WORK

組之處
SECTION/OFFICE
部門
DEPARTMENT

許可證號碼
Permit No.
地點
Location

第 1 部 —— 簽發 (由負責人員填寫)

PART 1. —— ISSUE (to be completed by Responsible Person)

本人謹此聲明，下述電力器具已根據電力(線路)規例工作守則第 4 條的安全規定，截斷電源、隔離、放電和接地（如需要），可以安全進行工程，本人已提醒負責工作人士注意這些安全規定。

I hereby declare that it is safe to work on the following electrical equipment which has been made dead, isolated, discharged and earthed (if necessary) in accordance with the safety precautions in Code 4 of the Code of Practice for the Electricity (Wiring) Regulations. I have drawn the attention of the Person in-charge of the work to these precautions.

本人已向負責工作人士，直接指出該電力器具，說明工程範圍以及講解安全措施。

I have physically identified the electrical equipment, explained the extent of the work and demonstrated the safety arrangements to the Person in-charge.

請在適當方格加上剔號
Please tick in the appropriate boxes

(一) 進行工程的電力器具

- (1) **ELECTRICAL EQUIPMENT TO BE WORKED ON**
- 高壓固定電力裝置 High Voltage Fixed Electrical Installation
- 低壓固定電力裝置 Low Voltage Fixed Electrical Installation

(甲) 配電箱及其下游部分 (A) Distribution Board and the Parts at Its Downstream

- | | |
|---|---|
| <input type="checkbox"/> 配電箱 Distribution Board | <input type="checkbox"/> 最終電路 Final Circuit |
| <input type="checkbox"/> 插座 Socket Outlet | <input type="checkbox"/> 雙極開關掣 Double Pole Switch |
| <input type="checkbox"/> 單極開關掣 Single Pole Switch | <input type="checkbox"/> 熔斷器連接盒 Fused Connection Unit |
| <input type="checkbox"/> 燈具 Luminaire | <input type="checkbox"/> 熱水爐 Water Heater |
| <input type="checkbox"/> 冷氣機 Air-Conditioner | <input type="checkbox"/> 抽氣扇 Exhaust Fan |
| <input type="checkbox"/> 其他 (請註明) Others (Please specify) | |

(乙) 配電箱的上游部分 (B) Upstream of Distribution Board

- | | |
|---|---|
| <input type="checkbox"/> 總掣櫃 Main Switchboard | <input type="checkbox"/> 上升總線 Rising Main |
| <input type="checkbox"/> 分配支電路 Distribution Sub-Circuit | <input type="checkbox"/> 支掣櫃 Sub-switchboard |
| <input type="checkbox"/> 匯流排 Busbar Chamber | <input type="checkbox"/> 模製外殼斷路器 MCCB |
| <input type="checkbox"/> 熔斷器開關掣 Fused Switch | <input type="checkbox"/> 其他 (請註明) Others (Please specify) |

(二) 電力器具的地點

(2) LOCATION OF ELECTRICAL EQUIPMENT

- | | |
|---|---|
| <input type="checkbox"/> 掣房 Switch Room | <input type="checkbox"/> 電錶房 Meter Room |
| <input type="checkbox"/> 電線房 Cable Duct Room | <input type="checkbox"/> 房號 Room No. |
| <input type="checkbox"/> 其他 (請註明) Others (Please specify) | |

(三) 要進行的工程詳情

(3) DETAILS OF WORK TO BE DONE

- 種類 Category
- | | | | | |
|---|--|---|------------------------------------|---|
| <input type="checkbox"/> 加裝 Addition | <input type="checkbox"/> 改變 Modification | <input type="checkbox"/> 更換 Replacement | <input type="checkbox"/> 維修 Repair | <input type="checkbox"/> 保養 Maintenance |
| <input type="checkbox"/> 定期檢查、測試及發出證明書 P/T/C | | | | |
| <input type="checkbox"/> 其他 (請註明) Others (Please specify) | | | | |

詳情 Details

(四) 隔離電力器具的確實位置

(4) EXACT POINT WHERE ELECTRICAL EQUIPMENT IS ISOLATED

- | | |
|--|---|
| <input type="checkbox"/> 四極空氣斷路器 4-pole ACB | <input type="checkbox"/> 四極模製外殼斷路器 4-pole MCCB |
| <input type="checkbox"/> 兩極微型斷路器 Double-pole MCB | <input type="checkbox"/> 其他 (請註明) Others (Please specify) |

(五) 電力器具接地的確實位置

(5) EXACT POINTS WHERE ELECTRICAL EQUIPMENT IS EARTHED

(六) 已鎖上安全鎖的位置

(6) SAFETY LOCKS APPLIED AT

(七) 警告告示和危險告示器立位置

(7) CAUTION NOTICES AND DANGER NOTICES HAVE BEEN POSTED AT

(八) 特別指示或安全措施

(8) SPECIAL INSTRUCTIONS, OR SAFETY MEASURES

姓名 Name: (負責人員) (Responsible Person) 簽署 Signed:

聯絡電話號碼 Contact Tel. No: 日期 Date: 時間 Time:

第 2 部 —— 簽收 (由負責工作人士填寫)

PART 2. —— RECEIPT (to be completed by Person in-charge)

本人確認收到工作許可證和安全鎖的鎖匙。本人已閱讀過此工作許可證的內容，並證實該電力器具已按需要要在上述地點切斷電源及隔離。有關的安全設備和接地線 (如適用) 均不會移走，直至此許可證被撤銷並得到負責人員的准許為止。

I acknowledge receipt of this permit-to-work and the key for the safety locks. I have read the content of this permit-to-work and I certified that where applicable the electrical equipment is switched off and isolated on these premises. Safety devices and earths (if applicable) will not be removed until this permit-to-work has been cancelled and permission has been obtained from the Responsible Person.

本人謹此聲明，本人接納此工作許可證上所述在該電力器具進行工程的責任，而本人及本人轄下人員，均不會在其他電力器具進行工程。

I declare that I accept the responsibility for carrying out work on the electrical equipment described on this permit-to-work and that no attempt will be made by me or by the persons under my control to carry out work on other electrical equipment.

在第 1 部所述的工程進行期間，本人會保留此工作許可證，並會在工程完成或停止後，將許可證交還負責人員。

I will retain this permit-to-work while the work described in Part 1 is in progress and will return it to the Responsible Person when the work is completed or stopped.

姓名 (負責工作人士) 簽署
Name: (Person in-charge) Signed:

聯絡電話號碼 日期 時間
Contact Tel. No: Date: Time:

受僱於
In the employ of

此許可證在第 1 及第 2 部簽署後才生效 THIS PERMIT IS NOT VALID UNTIL PARTS 1 AND 2 HAVE BEEN SIGNED

第 3 部 —— 撤離 (由負責工作人士填寫)

PART 3. —— CLEARANCE (to be completed by Person in-charge)

本人謹此聲明，此工作許可證第 1 部所述工程已圓滿完成/停止*，本人轄下所有人員已經撤離，並受到警告：在上述電力器具進行工程已不安全。所有工具及臨時接線均已撤走。

I hereby declare that work described in Part 1 of this permit-to-work has been satisfactorily completed/stopped*, and all persons under my charge have been withdrawn and warned that the above electrical equipment is no longer safe to work on. All tools and temporary connections have been removed.

簽署 (負責工作人士)
Signed: (Person in-charge)

日期 時間
Date: Time:

第 4 部 —— 撤銷 (由負責人員填寫)

PART 4. —— CANCELLATION (to be completed by Responsible Person)

本人謹此聲明，此工作許可證第 1 部所述工程已圓滿完成/停止*，此工作許可證現予以撤銷。工作許可證已交還本人並將交予相關註冊電業承辦商/固定電力裝置擁有人*，作最少五年保存。

I hereby declare that the work described in Part 1 of this permit-to-work has been satisfactorily completed/stopped* and that this permit-to-work is cancelled. The original permit-to-work has been returned to me and will be passed to the relevant Registered Electrical Contractor or owner of the fixed electrical installation for their keeping for at least five years.

簽署 (負責人員)
Signed: (Responsible Person)

日期 時間
Date: Time:

* 將不適用的刪除 Delete as appropriate.

測試許可證 (高壓)
SANCTION-FOR-TEST (High Voltage)

組/處	許可證號碼
SECTION/OFFICE	Permit No.
部門	地點
DEPARTMENT	Location.....

第 1 部 —— 簽發 (由負責人員填寫)

PART 1. —— ISSUE (to be completed by Responsible Person)

本人謹此聲明，下述高壓電力器具已根據電力(線路)規例工作守則第 4 條的安全規定，截斷電源、隔離、放電和接地 (如需要)，可以安全進行測試。本人已提醒負責工作人士注意該些安全規定。

I hereby declare that it is safe to test on the following high voltage electrical equipment which has been made dead, isolated, discharged and earthed (if necessary) in accordance with the safety precautions in Code 4 of the Code of Practice for the Electricity (Wiring) Regulations. I have drawn the attention of the Person in-charge of the work to these precautions.

本人已向負責工作人士，直接指出該高壓電力器具，說明測試範圍以及講解安全措施。

I have physically identified the high voltage electrical equipment, explained the extent of the test and demonstrated the safety arrangements to the Person in-charge.

(一) 進行測試的高壓電力器具

(1) **HIGH VOLTAGE ELECTRICAL EQUIPMENT TO BE TESTED ON**

(二) 高壓電力器具的地點

(2) **LOCATION OF HIGH VOLTAGE ELECTRICAL EQUIPMENT**

(三) 要進行的測試詳情

(3) **DETAILS OF TEST TO BE DONE**

(四) 隔離高壓電力器具的確實位置

(4) **EXACT POINT WHERE HIGH VOLTAGE ELECTRICAL EQUIPMENT IS ISOLATED**

高壓隔離

(HIGH VOLTAGE ISOLATION)

低壓隔離

(LOW VOLTAGE ISOLATION)

(五) 已鎖上安全鎖的位置

(5) **SAFETY LOCKS APPLIED AT**

(六) 警告告示和危險告示豎立位置

(6) **CAUTION NOTICES AND DANGER NOTICES HAVE BEEN POSTED AT**

(七) 高壓電力器具接地的確實位

(7) **EXACT POINTS WHERE HIGH VOLTAGE ELECTRICAL EQUIPMENT IS EARTHED**

(八) 特別指示或安全措施

(8) **SPECIAL INSTRUCTIONS, OR SAFETY MEASURES**

姓名 (負責人員) 簽署
Name: (Responsible Person) Signed:

聯絡電話號碼 日期 時間
Contact Tel. No: Date: Time:

第 2 部 —— 簽收 (由負責工作人士填寫)

PART 2. —— RECEIPT (to be completed by Person in-charge)

本人確認收到測試許可證和安全鎖的鎖匙。本人已閱讀過此測試許可證的內容，並證實該高壓電力器具已按需要在上述地點切斷電源及隔離。

I acknowledge receipt of this sanction-for-test and the key for the safety locks. I have read the content of this sanction-for-test and I certified that where applicable the high voltage electrical equipment is switched off and isolated on these premises.

本人謹此聲明，本人接納此測試許可證上所述在該高壓電力器具進行測試的責任，而本人及本人轄下人員，均不會在其他電力器具進行測試。

I declare that I accept the responsibility for carrying out testing of the high voltage electrical equipment described on this sanction-for-test and that no attempt will be made by me or by the persons under my control to test on other electrical equipment.

在第 1 部所述的測試進行期間，本人會保留此測試許可證，並會在測試完成或停止後，將許可證交還負責人員。

I will retain this sanction-for-test while the test described in Part 1 is in progress and will return it to the Responsible Person when the test is completed or stopped.

姓名 (負責工作人士) 簽署
Name: (Person in-charge) Signed:

聯絡電話號碼 日期 時間
Contact Tel. No: Date: Time:

受僱於
In the employ of

此許可證在第 1 及第 2 部簽署後才生效
THIS PERMIT IS NOT VALID UNTIL PARTS 1 AND 2 HAVE BEEN SIGNED

第 3 部 —— 撤離 (由負責工作人士填寫)
PART 3. —— CLEARANCE (to be completed by Person in-charge)

本人謹此聲明，此測試許可證第 1 部所述試驗已圓滿完成/ 停止*，本人轄下所有人員已經撤離，並受到警告：在上述高壓電力器具進行測試已不安全。所有工具及臨時接線均已撤走。現時的接地安排跟此測試許可證第 1 部所述的一樣/ 跟附圖所述的一樣*。

I hereby declare that test described in Part 1 of this sanction-for-test has been satisfactorily completed/stopped*, and all persons under my charge have been withdrawn and warned that the above high voltage electrical equipment is no longer safe to test on. All tools and temporary connections have been removed. The current earthing arrangement is the same as that specified in Part 1 of this sanction-for-test / has been changed as shown in enclosed drawings*.

簽署 (負責工作人士)
Signed: (Person in-charge)

日期 時間
Date: Time:

第 4 部 —— 撤銷 (由負責人員填寫)
PART 4. —— CANCELLATION(to be completed by Responsible Person)

本人謹此聲明，此測試許可證第 1 部所述測試已圓滿完成/ 停止*，此測試許可證現予以撤銷。測試許可證已交還本人並將交予相關註冊電業承辦商/ 固定電力裝置擁有人* 作最少五年保存。

I hereby declare that the test described in Part 1 of this sanction-for-test has been satisfactorily completed / stopped* and that this sanction-for-test is cancelled. The original sanction-for-test has been returned to me and will be passed to the relevant Registered Electrical Contractor or owner of the fixed electrical installation for their keeping for at least five years.

簽署 (負責人員)
Signed: (Responsible Person)

日期 時間
Date: Time:

* 將不適用的刪除 Delete as appropriate.

Appendix 18

New Cable Colour Code for Fixed Electrical Installations Installation Guidelines

(1) Introduction

With effect from 1 July 2007, colour for identification of conductors in fixed electrical installations is changed as shown in Table 13(2) of the CoP.

The change is applicable to all new electrical installations as well as addition & alteration to existing electrical installations. Existing installations with cables adopting the old cable colour code are not affected.

A Working Group on the Review of Cable Colour Code in Hong Kong comprising members from the trade and industry was established in year 2003 to study the cable colour change issue in Hong Kong. In mid 2004, the Working Group proposed to adopt the new cable colour code in Hong Kong. The change was then endorsed by the Electrical Safety Advisory Committee in September 2004.

The new cable colour code complies with the requirements of relevant national and international standards (such as IEC 60446, EN 60446, BS EN 60446 and BS 7671) and has been adopted by the majority of the western countries (e.g. UK, France, Germany, Spain, Netherlands, Portugal etc.).

(2) Implementation

The new colour code may be used for those electrical installation works commencing on-site on or after 1 July 2007. For installation works commencing on-site from 1 July 2007 to 30 June 2009 (i.e. the 2-year grace period), either the new or the old colour code, but NOT both, can be used. For installation works commencing on-site on or after 1 July 2009, only the new colour code should be used.



Figure A18(1) - Implementation Schedule

(3) Precautions

In the new colour code, the black core is changed from neutral to phase and the blue core from phase to neutral (see Table 13(2)). Wrong connection of these cores will lead to increased risk, leading to possible electrical accidents and short circuiting, in particular during the transition period. To ensure electrical safety, it is recommended not to conduct, whenever practicable, works on "LIVE" installations at any cable colour change interfaces. Where serious inconvenience would arise from isolating electrical circuits for works at the cable colour code change interfaces, adequate safety precautions should be taken to avoid danger from "LIVE" working conditions (see Code 4 of the CoP for details).

(4) Installation Guides - New Installation

The old cable colour code, i.e. red, yellow and blue for phase conductors and black for the neutral conductor, are to be replaced by the new one, i.e. brown, black and grey for phase conductors and blue for the neutral conductor, as specified in Table 13(2). Circuits for new installations should be wired in new colour coded cables (see examples in Figures A18(2a) and (2b)).

For a single phase installation, only the brown colour should be used to identify a phase conductor, irrespective of whether it is connected to the L1, L2 or L3 phase. For a room / flat /unit taking single phase electricity supply from a multi-phase power supply source, only brown (phase) and blue (neutral) colour coded cables should be used.

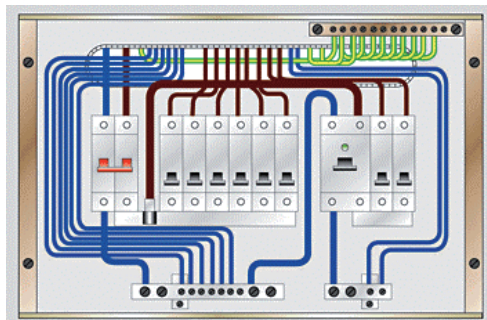

Figure A18(2a) - New colour coded wiring cables in a single phase distribution board

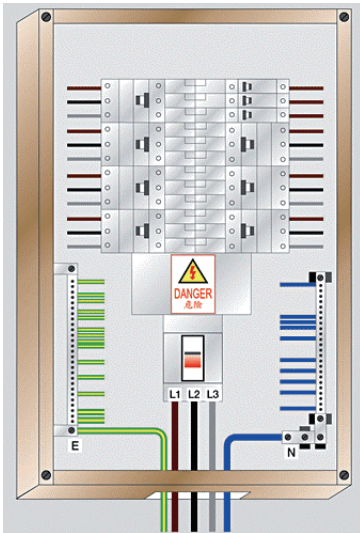

Figure A18(2b) - New colour coded wiring in a 3-phase distribution board

(5) Installation Guides - Extensions, Alterations or Repair to an Existing Installation

5.1 Warning Notice

Where new cables are installed in an existing installation with old colour coded cables, a yellow warning notice in both English and Chinese (see Figure A18(3)) should be displayed at or close to the nearest upstream distribution board (e.g. main switchboard, sub-main distribution board or consumer unit) of the affected installation. The warning notice should comply with the requirements specified in Code 17F of the CoP.



Figure A18(3) - Warning Notice

5.2 Single-phase installation

Extension, alteration or repair to an existing single-phase installation should be wired in the colour code of brown (for phase conductor), blue (for neutral conductor), and green-and-yellow (for protective conductor) as specified in Table 13(2).

- a. Existing cables adopting colour code of red for phase and black for neutral

If the existing single phase installation has adopted the colour code of red for phase conductor and black for neutral conductor (i.e. correctly identified), both the new and old colour coded cables are considered unambiguously marked. It is therefore not necessary to provide additional marking / label at the interface between new and old colour coded cables (see Figure A18(4)).

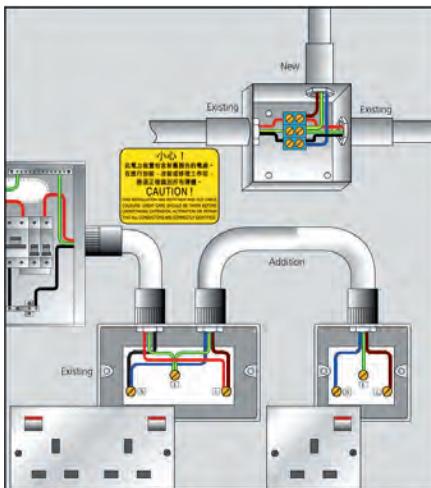

Figure A18(4) - Extension, alteration and repair to an existing single phase installation, where existing phase conductors are identified by red colour

- b. Existing cables adopting either colour code of yellow or blue for phase and black for neutral

Proper durable and legible labels or coding (such as cable ties, sleeves, ferrules etc.) should be provided on the new cables near the cable termination interface (see Figures A18(5a) to (5d)). The above provision is to standardize the wiring work for incorrectly identified cables and to avoid any possibility of mistaking the old "blue" colour coded (phase) cable as the new "blue" (neutral) colour coded cable.

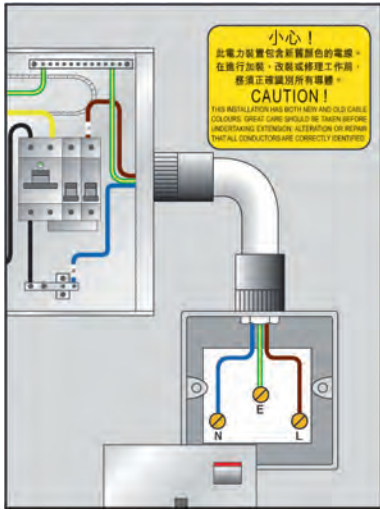

Figure A18(5a) - Addition of new colour coded cables to an existing MCB board where phase conductor is identified by yellow colour

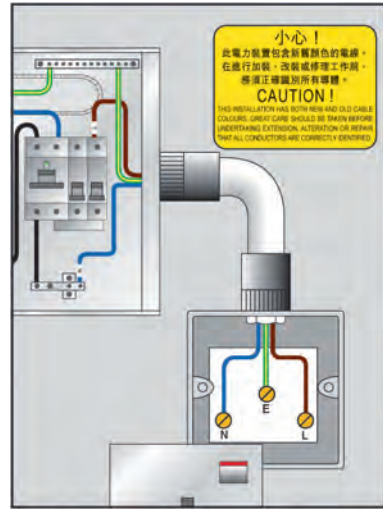

Figure A18(5c) - Addition of new colour coded cables to an existing MCB board where phase conductor is identified by blue colour

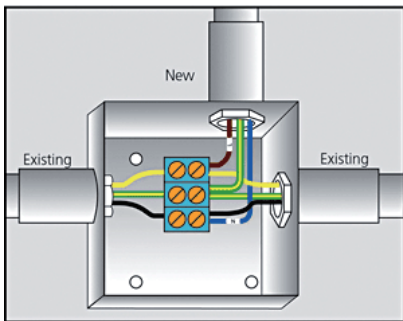

Figure A18(5b) - Extension, alteration and repair to an existing single phase installation where phase conductor is identified by yellow colour

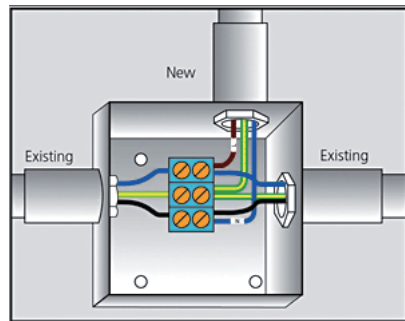

Figure A18(5d) - Extension, alteration and repair to an existing single phase installation where phase conductor is identified by blue colour

5.3 Three-phase installation

Extension, alteration or repair to an existing 3-phase installation should be wired in the new colour code of brown/ black/ grey/ blue/ (green-and-yellow) as specified in Table 13(2).

At the wiring interface, both the new and old phase and neutral conductors should be fitted with proper, durable and legible identification marked in L1, L2, L3 and N (Figure A18(6)).

For the interface between new and old colour coded cables at a busbar chamber for an existing three-phase installation, an acceptable means of identification is illustrated in Figure A18(7).

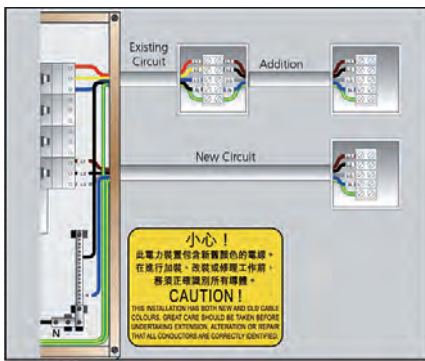

Figure A18(6) - Extensions, alterations or repairs to an existing three-phase installation

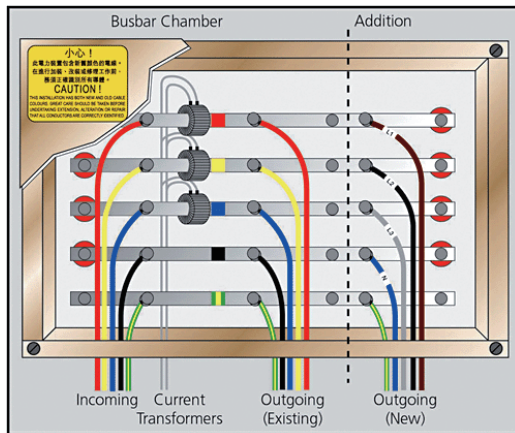

Figure A18(7) - Interface between new and old colour coded cables at a busbar chamber for an existing three-phase installation

INDEX

Alterations and additions to installation	18A
Automatic disconnection of supply	9A(1), 11A, 11B(a), 11B(c), 11I(a), 26H(5)(d), 26M(4)(b), 26M(6)(a), 26N(4)(a)
Basic protection	2, 13B, 26L(3), 26N(2), 26N(3)
Bathroom installations	
equipotential bonding	26A(3)(b)
RCD	26A(3)(a)
SELV	26A(3)(d)
shaver supply unit	26A(3)(d), 26A(3)(e)
Bell	5A(a), 6B(1)(b), 7B(3)(b), 26A(6)(a)
Bonding	2, 4C(2)(c), 11, 12B, 15E(f), 17B, 21B, 21C, 25D(8), 26A(3), 26K(3), 26L(3), 26M(3), 26M(5), 26N(4)
Breaking capacity	6D(b), 9A(2)(c), 9C(1), 9C(2), Table 9(2)
Busbars	
cables connected to	15B(3)(c)
identification of	Table 13(2)
trunking	2, 14A, 14F, 26B
Cable(s)	
bracket	11D(2)(b)
buried underground	11H(a), 13D(3), 15E(c), 25C(3)(a)
channel	2, 14A(3)(b), 15B(4)(b)
cleat	25C(1)(d), 25C(1)(e)
colour code	Table 13(2), 17F
identification	6B(3)(b), 13D(2)(a), 13D(2)(b), Table 13(2)
current-carrying capacity	Table 5(1), 6B(1)(a), 6B(6)(c), Table 6(1), 9B(1)(d), 9D(2), 9D(3), 13A(1), 13A(3), 15B(3)(a), 21A(d), 26A(5)(a)
ducting	2, 5B(2), 5B(3), 5C(a), Table 5(1), Table 5(2), 11C(1), 11C(2), 11D(2)(a), 11E(a), 13A(2)(h), 14A(1)(b), 14A(2), 14A(3), 15A(2), 15B(4)(b), 15E(f), 15G(b), 26O(f)

enclosure	2, 4B(1)(c), 4C(2)(a), 4D(1)(b), 4E(f), 4F(1)(a), 5B(2), 5B(3), 5B(4), 5C(c), Table 5(1), Table 5(2), 6C(b), 9E(a), 11C(1)(b), 11C(2)(a), 11C(2)(d), 11D(2)(a), 11D(3)(a), 11D(3)(d), 14A(1), 14A(2), 14E(1), 15A(2), 15B(1)(b), 15B(4), 15C(f), 15E(e), 21A(g), 26H(4)(c), 26K(3)(e), 26O(f)
in conduit and trunking	2, 5B(2)(b), 5B(3)(b), 5C(a), Table 5(1), Table 5(2), 11C(1)(b), 11D(2)(a), 11D(3)(b), Table 11(1), 13A(2)(h), 14A, 14B, 14D, 14E(2), Table 14(2), Table 14(3), 15E(e), 15E(f), 25A(1)(e), 25A(1)(g), 25B(1)(c), 25C(1)(f), 25C(2)(c), 26O(f)
in parallel	9B(1)(e), 12C(3)(b), 26O(f)(iv)
installed in wall	15E(f), 25C(1)(a) 25C(1)(g)
installed under floors or above ceiling	15E(e), 25C(1)(f)
joints	4B(1)(c), 9B(1)(a), 11F(a), 13C, 15A(2)(b), 16C, 25D(1), 25D(3), 25D(5)(a), 25D(7)(b)
method of installation	13A(2)(d), 21B(10)(b)
sealing	14A(3), 15A(2)(b), 15A(2)(e), 25A(1)(c), 25C(1)(g), 25C(2)(b), 25D(7)(c)
segregation	5
supports	15E(e), 15F, 15G(d), 15G(e), 16B, 16H(2), 25C(1)(b), 25C(1)(f), 25C(4)(d), Table 25(3), 26H(4)(d), 26K(3)(b)
trunking	2, 5C(a), 11C(2)(e), 14E(2), 15B(4), 25B, 25C(1)(f)
Circuit arrangement	6, 6C, 6F(2)(i), 6G(2)(f), 26A(2)(a)
Circuit breaker	
breaking capacity	6D(b), 9C(1), 9C(2)(b), Table 9(2)
definition	2
linked	8A(1)(a), 9E(g), 10A, 10B, 26A(5)(a)
Circuit protective conductor	2, 6C(b), 11C(1)(a), 11D(1), 11D(3), 11G(a), 14B(2)(c), 25A(1)(a), 25D(6), 25D(7), 26A(5)(c), 26O(f)
Circuits	
category	3B, 5A, 5B, 5C, Table 5(1), Table 5(2), 13A(2)(h), 25C(3)(a), 26G
division of installation	6A

final	4G(3), 6B(1)(b), 6B(4), 6C(c), 6D, 6E(2), 6E(4), 6F(1), 6F(2), 6G(2), 6H(2), Table 6(1), 7B(3), 7B(4), Table 7(1), 11D(3)(d), 21B(2)(a), 21B(3), 25A(1)(g), 25C(2)(f), 25D(1), 26A(1), 26A(2)(b), 26A(3)(e), 26A(4), 26A(5)(d), 26O(e), 26O(f)
isolation	4C(2)(c), 4E(a), 5A(b), 6B(2), 8A(1), 8A, 8B, 21A(h), 26H(2)
Class II equipment or insulation	26M(5)(d), 26N(4)
Concealed cables	15E(f)
Conductive parts	
exposed conductive parts	2, 4C(2)(c), 11A, 11B(a), 11D, 11F(b), 11F(d), 12B(2), 14D(2), 21B(6)(f), 21C(b), 25D(5)(a), 25D(8)(a), 26A(3)(a), 26A(3)(b), 26E, 26H(7), 26M(3), 26O(f)
extraneous conductive parts	2, 4C(2)(c), 11B(a), 11B(b), 11E(a), 11F, 21B(4), 25D(5)(a), 25D(8)(a), 26A(3)(a), 26A(3)(b), 26M(3), 26N(4)(c)
Conduit and conduit system	2, 5B(2)(b), 5B(3)(b), 5C(a), Table 5(1), Table 5(2), 11C(1), 11C(2)(a), 11D(2), 11D(3), Table 11(1), 13A(2), 14A, 14B, 14D, 14E, 14F, Table 14(2), Table 14(3), 15A(2), 15D(3), 15E, 15G(b), 25A, 25B, 25C(1), 25D(8), Table 25(1), 26A(3)(f), 26M(5)(b), 26O(f)
Conduit box/junction box	14A(1)(b), 14B(1)(c), 14B(2)(b), 14D(1)(c), 14D(2)(b), 25A(1)(b), 25A(3), 25D(1), 25D(2), 25D(8)(b), 25D(8)(c), 26M(5)(b)
Construction site installations	21E(4)(c), 26K(2)(b), 26K(3)
Current-carrying capacity	
cables and conductors	Table 5(1), 6B(1)(a), Table 6(1), 9B(1), 9D(2), 9D(3), 13A(1), 13A(3), 15B(3)(a), 21A(d), 26A(5)(a)
neutral	6B(1)(a), 6B(6), 26A(5)(a), 26B(3)(a), 26F(b), 26H(1)(d)
parallel conductors	9B(1)(e), 12C(3)(b), 26O(f)
Diagrams, provision of	6A(b), 8A, 21A(m), 22C(a)
Discharge lighting	7B(3)(b), 8A(2)(b), 8B(2)(d), 20A(3)(b), 26H
Disconnection time	11B(b)

Double insulation	5A(b), 11D(1), 11D(2)
Duct	2, 5B(2)(b), 5B(3)(b), 5C(a), Table 5(1), 13A(2)(h), 14A(3), 15A(2)(h), 15B(4)(b), 15E(c)
Earth fault current	2, 11, 11J, 12B(3), 18A(b)
Earth-free local equipotential bonding	26L(3)(b)
Earthed equipotential bonding	11A
Electric Heating Systems in Building Structures	26R
Electric Vehicle	26S
Electrical equipment, safety requirement	4, 15D, Table 15(4)
Emergency switch	8A(3), 8A(6), 8B(1)(c), 8B(4), 26H(3)
Equipotential bonding	2, 4C(2)(c), 11A, 11B(b), 11C, 11E, 11F, 21B(2)(a), 21B(4), 25D(8)(a), 26A(3), 26L(3)(b), 26M(3), 26M(5)(d), 26N(4), 26Q(3)(b)
Equipotential zone	11B(b), 11E, 11F(a)
Exhibitions, shows and stands	26Q
Explosive atmosphere	4B(2)(b), 15D(1)(a), 15D(2)(c)
Exposed conductive parts	2, 4C(2)(c), 11A, 11B, 11D, 11F, 12B(2), 14D(2)(b), 21B(6)(f), 21C(b), 25D(5)(a), 25D(8)(a), 26A(3), 26E, 26H(7), 26M(3), 26N(4)
Extraneous conductive parts	11F(b)
bathroom	11B(b), 26A(3)
bonding of	4C(2)(c), 11E(a), 11F, 21B(4), 25D(8)(a), 26(3)(b), 26M(3), 26N(4)(c)
swimming pools	26M(3)
Fault	2, 6B(1), 8A(1), 9A(1), 9A(3), 9B(2), 9C(1), 9C(2), 9D(3), Table 9(2), Table 9(3), 11A, 11B, 11I, 11J, Table 11(5), Table 11(8), Table 11(9), Table 11(10), Table 11(11), Table 11(12), Table 11(13), Table 11(14), 13A(1), 18A(b), 21B(2), 21B(8), 21B(9), 21B(10), 26A(3)(a), 26H(5), 26K
Fault protection	2, 11A, 11J(2)(c), 21A(o), 26N(2), 26N(4)

FELV	26N(2)
Festive lighting	26Q
Final circuits	
arrangement	4G(3), 6B(1)(b), 6C, 6D, 6E, 6F, 6G, 6H, Table 6(1), 7B(3), 7B(4), Table 7(1), 26A(4)(a)
ring	6C, 6E, 6F, Table 6(1), 11D(3)(d), 21B(4)
separation of joint	6B(4) 25D(1)
Fire barriers	14A(3), 21A(f)
Fuse	2, 4D(1)(a), 4E(d), 6D(b), 6E(2), 6E(4), 6F, 6G, Table 6(1), 8B(2)(b), 9A(2), 9B(1)(d), 9E, Table 9(2), 10A(b), 10B, Table 11(3), Table 11(4), Table 11(8), Table 11(9), Table 11(11), Table 11(12), 13A(4)(d), 21A(j), 21B(5)(c), 21B(6)(a), 21B(9)(b), 21B(10)(d), 26A(4)(a), 26A(5), 26A(6)(e)
Generator	8A(1)(d), 10C, 26K(3)(f), 26N(4)(f), 26Q(3)(f)
Harmonic current	4D(3), 6B(6)(c), 7B(3)(b), 26H(1)(b)
High voltage	4F(1)(c), 4F(1)(d), 4H, 5C, 6I, 8A(7), 13A(2)(h), 14E, 21D, 25C(1)(i), 25D(9), 26K(3)(a)(i)
High voltage discharge lighting	8A(2)(b), 8B(4)(d), 20A(3)(b), 26H
Inspection and testing	4D(3), 22D(1), 22D, 26K(2)(b), 26P(3)
Instantaneous water heater	Table 7(1), 26A(5)
Insulation	4C(1)(c), 9B(1)(a), Table 9(1), 13A(3), 13A(4)(e), 13B(1), 14E(2)(d), 15A(2), 15B(2), 15B(3), 15B(5)(b), 15G(a), Table 15(1), Table 15(2), 21A(g), 21B(2)(a), 21B(5), 21B(10)(a), 21E(2), Table 21(1), 25D(3)(b), 26H(5)(a), 26L(5)(c), 26N(2)(b)
Isolation	
motor circuit	8A(3), 8A(4)
neutral conductor	6B(6), 8A(1)(a), 8B(2)(a), 10A(b), 26D(b), 26H(3)(a)
plug and socket outlet	8A(2)(a), 26A(5)(c), 26O(c)
remote devices	8A(4)(a)

requirement	4C(2)(c), 6B(2), 8A, 8A(2), 8B, 21H(2), 26Q(3)(e)
Joints	
cable and conductor	13C(b), 13C(g), 15B(3)(a), 25D
conduit system	25A(1)(a), 25A(2)(a), 25A(3)(b)
earthing system	11H(d)
Joints and termination	25D(3)(a), 25D(6)
Labels	
bonding conductor	17B
main earth terminal	11G(d)
Leakage current	18A(b), 26A(5)(a), 26O
Lightning protection	11E(a), 11H(f), 26I
Live work	2, 4G(1)(d), 8A(1)(a)
Main earthing terminal	2, 11D(1), 11E(a), 11G, 11H(c), 12A, 12B, 16I(a), 26A(5)(c), 26K(3)(d)
Main equipotential bonding	11B(b)(v), 11C(1)(a), 11E, 11F(a), 25D(8)(a)
Main switch for installation	8A(1)
Maintenance	4D, 4E(c), 4F(2)(c), 4F(3)(a), 4F(4), 4H(1), 4H(3), 8A(5), 8B(1), 8B(3), 9D(1), 11H(c), 13C(h), 15G(a), 21A(a), 21D(2), 22A(b), 22C(b), 25C(1)(f), 26K(4), 26P(3)
MCB (Miniature circuit breaker)	6D(b), 6E(4), 6F(2)(h), Table 6(1), 8B(2)(b), 9A(2)(a), 9A(3)(d), 9E(g), Table 11(5), Table 11(6), Table 11(10), 21A(e), 21B(9)(b), 26A(4)(a)
MCCB (Moulded case circuit breaker)	8B(2)(b), 9A(2)(b), 9A(3)(d), Table 11(7), Table 11(13)
Motor	
automatic restarting	8A(4)(c), 26C(3)(b)
control equipment	26C(1)(a)
isolation	8A(4)(a)
Neutral	
harmonic current	6B(6)(c)
isolation of	8A(1)(a), 8B(2)(a), 10A, 10B, 26H(3)(a)
links	8A(1)(a), 8B(2)(a), 10A, 10B

Notice	
periodic inspection and testing	17D, 20B(3)
RCD periodic testing	17E
Overcurrent	2, 6B(1)(a), 6F(2)(b), 6F(2), 6G(2), 6H(2), Table 6(1), 7B(3)(a), 8B(2)(a), 9A, 9B, 9C, 9D, 9E, Table 9(2), 11B(c), 11J(1)(a), 11J(2)(c), 13A(3)(a), 18A(b), 26A(5)(a), 26A(6)(b), 26B(3)(b), 26K(3)(c), 26O(d)
Overcurrent protective device	
coordination	11J(2)(e), 26K(3)(c)
discrimination	11J(2)(e), 26K(3)(c)
selection and erection of	6B(1), 6H(2), 7B(3)(a), 9A(3)(c), 9B, 9C, 9D, 9E, Table 9(2), 13A(3)(a)
Parallel cables	9B(1)(e), 12C(3)(b)
Parallel operation	6B(1)(c), 10C
Periodic inspection and testing	20, 22A, 22D(1)
Plugs	2, 4G(6), 6E(4), 6F(1), 8A(2), 8B(2), 8B(3)(b), 8B(4)(e), 26A(1)(a), 26A(4)(b), 26A(5)(c), 26A(6)(a), 26H(1)(a), 26K(3)(e), 26O(c), 26O(d)
Potentially explosive atmosphere	4B(2)(b), 15D(1)(a), 15D(2)(c), Table 15(4)
Powertrack system	2, 14F
Protective Conductors	2, 6C(b), 8A(1)(e), 11B(b), 11C, 11D, 11F(d), 11G(a), Table 11(1), Table 11(2), Table 11(3), Table 11(4), Table 11(5), Table 11(6), Table 11(7), 13D(2)(c), Table 13(2), 14A, 14C(2)(b), 14D(2)(a), 15A(2), 15E, 16I(a), 20B(2), 21A(e), 21B(2)(a), 21B(3), 21B(4)(a), 21B(5)(f), 21C(b), 25A(1)(a), 25A(2)(b), 25D(5), 25D(6), 25D(7), 26A(3)(e), 26A(5)(a), 26A(5)(c), 26H(7), 26M(3), 26O
Renewable energy power system	26P
RCD (Residual current device)	2, 11B(b), 11I(b), 11J, Table 11(14), 16I(b), 17E, 21A(e), 21B(9)(a), 26A(3)(a), 26A(5)(a), 26K(3)(d), 26L(3), 26M(4)(c), 26M(5)(c), 26M(5)(d), 26N(4)(a), 26O(b), 26O(d), 26Q(3)(b)

Restrictive conductive location	26N
Segregation of circuits	5
SELV circuits	2, Table 21(1), 26A(3), 26L(3)(d), 26M(4), 26M(5), 26M(6)(a), 26N(2), 26N(4)
Shaver supply unit	26A(3)(d), 26A(3)(e)
Short circuit	2, 4A(4), 8B(2)(a), 21B(5)(e)
Socket outlets	
general installations	4C(1), 4D(1), 6C, 6D, 6E, 6F, 6G, 6H, Table 6(1), 7B(3)(b), Table 7(1), 8A(2)(a), 8B(4)(e), 11B(b), 11D(3)(a), 11F(b), 11J(2), 21A, 21B(5)(b), 21B(6), 25E, 26A(1), 26A(2), 26A(4)(b), 26A(5)(c), 26K(3)(d), 26K(3)(e), 26M(5), Table 26(1)
in bathroom	26A(5)(c)
isolation	8B(2)(b)
requirement	6C, 6D, 6E, 6F, 6G, 6H, 15A(3), 26Q(3)(a)
Switchgear	4E(a), 4E(b), 4F(4), 4H(2)(d), Table 7(1), 11C(2)(e), 11D(2)(a), 14A(1)(a), 26L(4)(d), 26M(5)(c)
Switchgear and controlgear assembly	11C(2)(e), 11D(2)(a), 14A(1)(a)
Switchgear enclosure used as protective conductor	14A(1)
Symbols	21E(6), 22C(a)
Temporary electrical installation	26Q
Temporary supply installation	26K
TN-S system	26K(3)(f), 26Q(3)(f)
TT system	26O(g)
Warning notice	4C(2)(b), 4F(1)(a), 4G(1)(f), 4H(3)(b), 11G(d), 11H(e), 17A, 17B, 17C, 17F, 17C, 21A(l)
Water heater	6E(3)(b), Table 7(1), 26A(3)(d), 26A(5)
Workmanship	1, 4A(1), 4B, 13C(b), 14G, 25



P59651500E0

\$71

Electricity Legislation  **EMSD**

3 Kai Shing Street, Kowloon, Hong Kong

Tel: (852) 1823

Fax: (852) 2895 4929

Website: www.emsd.gov.hk

Email: info@emsd.gov.hk